



MOTOROLA



When printed by Motorola

***MTM800
TETRA Motorcycle Terminal
Feature User Guide***

Contents

General Information	1
Safety Information	1
Disposal Information	1
Copyright Information	2
Product Specific Information	2
Icon Conventions	3
Getting Started	5
How to Use this Guide	5
Controls and Indicators	6
The Display	9
LED Status Indicators	11
Powering On/Off	11
Key Overview	13
Home Mode Display	19
Terminal Disable/Enable	19
Terminal Permanent Disable	20
Making Calls	20
VOX Control	20
Receiving Calls	21
Busy User Pre-emption (BUP)	21
Pre-emptive Calling (PPC)	22
Broadcast Call	23
Ambience Listening (AL)	24
Cancelling an Incoming Call	24
Covert Mode	24
Local Area Service	24
Dimming the Display	26
Adjusting the Volume	26
Horn & Lights Alarm On/Off	26
Packet Data	27
Looking after your MTM800	27

TMO Group Call	28
General	28
Selecting a Talkgroup	29
Changing a Talkgroup during/on receiving a call	32
Selecting a Range	32
Activating/deactivating Scanning	33
Making a Group Call	33
Receiving a Group Call	34
Transmit Inhibit	36
Dynamic Group Number Assignment (DGNA)	37
 DMO Group Call	 40
General	40
Selecting a Talkgroup	41
Changing a Talkgroup during/on receiving a call	41
Switching from TMO to DMO or from DMO to TMO	41
Gateway/Repeater Selection	41
Making a DMO Group Call (MS to MS)	44
Making a DMO Group Call via Gateway	45
Making a DMO Group Call via Repeater	45
Making a DMO Group Call via Gateway and Repeater	46
Receiving a DMO Group Call	47
DMO Private Call	48
Receiving an Emergency Group Call	48
 Private Call	 49
General	49
Entering Private Mode	49
Entering the Private Number	50
Making a Private Call in TMO	50
Making a Private Full-Duplex Call in TMO	51
Receiving a Private Call in TMO	51
Receiving a Private Full-Duplex Call in TMO	51
Private Call in DMO	52
Dialing on receiving a call	53
Making a Private PPC (Pre-emptive Priority Call)	53

Call Queuing	53
Phone and PABX Calls	54
General	54
Making a Phone or PABX Call	54
Dialing on receiving a call	56
Answering a Phone or PABX Call	56
Emergency Mode	58
General	58
Entering TMO or DMO	59
Entering or Exiting Emergency Mode	59
Invisible Emergency	60
Changing Range or Talkgroup	60
Emergency in TMO	61
Emergency in DMO	63
GPS Location Service	65
General	65
Enhancing GPS Performance	66
GPS Enable/Disable	67
Entering GPS Location Service	67
The Menu	69
Entering the Menu Options	69
Exiting the Menu Options	69
Exiting the Menu	69
List of Menu Options	70
Messages	72
Address Book	72
Security	75
Setup	80
Own Number	87
Network	88
Scan	90
Recent Calls	92

Location	93
Packet Data	93
Messages	96
General	96
Entering the Messages Sub-menu	96
Sending a Status Message	97
Using the Inbox	98
Sending a Text Message	101
What to do if...	106
Tones	109
Index	112
Quick Reference Guide	117

© Motorola Inc., 2008

MOTOROLA and the stylized M Logo are registered in the U.S. Patent and Trademark Office. All other product or service names are the property of their respective owners.

General Information

Safety Information



CAUTION

Before using these products, read the operating instructions for safe usage contained in the Product Safety and RF Exposure booklet Safety Leaflet 6866537D37.

The accessories are restricted to occupational use only to satisfy ICNIRP RF energy exposure requirements. Before using the products, read the RF energy awareness information and operating instructions in the Product Safety and RF Exposure booklet (Motorola Publication part number Safety Leaflet 6866537D37) to ensure compliance with RF energy exposure limits.

Keep this **User Guide** and the **Product Safety and RF Exposure booklet** in a safe place and make it available to other operators in case the accessories are passed on to other people.

Disposal Information



The **European Union's Waste of Electrical and Electronic Equipment** directive requires that products sold into EU countries must have the crossed out trashbin label on the product (or the package in some cases). As defined by the WEEE directive, this cross-out trashbin label means that customers and end-users in EU countries should not dispose of electronic and electrical equipment or accessories in household waste.

Customers or end-users in EU countries should contact their local equipment supplier representative or service centre for information about the waste collection system in their country.

Copyright Information

The Motorola products described in this manual may include copyrighted Motorola computer programs stored in semiconductor memories or other mediums. Laws in the United States and other countries preserve for Motorola certain exclusive rights for copyrighted computer programs, but not limited to, including the exclusive right to copy or reproduce in any form the copyrighted computer program. Accordingly, any copyrighted Motorola computer programs contained in the Motorola products described in this manual may not be copied, reproduced, modified, reverse-engineered, or distributed in any manner without the express written permission of Motorola. Furthermore, the purchase of Motorola products shall not be deemed to grant either directly or by implication, estoppel, or otherwise, any licence under the copyrights, patents, or patent applications of Motorola, except for the normal non-exclusive licence to use that arises by operation of the law in the sale of a product.

Product Specific Information

- Max RF Power 3 Watts
- Max. Speaker Load 10 Watts at 4 Ohms
- Antenna Impedance 50 Ohms
- Ambient Temperature Range - 30 °C to + 60 °C



WARNING

*If the terminal is in service the surface temperature can rise up to 70 °C.
Do not touch the hot surface*

- Operating Time Continuous / Intermittent

NOTE

In general, the terminal transmit and receive time (operating cycle time) is determined by the communication system. On overload, respectively on extensive use beyond the systems specifications at high ambient temperatures, the terminal is protected by its thermal control, which cuts down the RF output power, thus reducing the terminal coverage range.

Icon Conventions

The document set is designed to give the reader more visual cues. The following graphic icons are used throughout the documentation set. These icons and their associated meanings are described below.

**WARNING**

The signal word Warning with the associated safety icon implies information that, if disregarded, could result in death or serious injury, or serious product damage.

**CAUTION**

The signal word Caution with the associated safety icon implies information that, if disregarded, may result in minor or moderate injury, or serious product damage.

CAUTION

The signal word Caution may be used without the safety icon to state potential damage or injury that is not related to the product.

NOTE

Notes contain information more important than the surrounding text, such as exceptions or preconditions. They also refer the reader elsewhere for additional information, remind the reader how to complete an action (when it's not part of the current procedure, for instance), or tell the reader where something is located on the screen. There is no warning level associated with a Note.

Getting Started





Congratulations on your purchase of the Motorola MTM800. Enhanced TETRA features and state-of-the-art technology help to keep you in constant touch with all of your work and personal contacts.

You can operate your MTM800 in English, German, French, Spanish, Dutch, Swedish, or in a language defined by your Service Provider. The default setting from factory is English. For more information, please see “Setting the Display’s Working Language” on page 81.

How to Use this Guide

This guide describes the MTM800 features as setup and pre-programmed at the factory.

Your Service Provider or your organisation may have customised your MTM800 to optimise its use for your individual needs. Check with your Service Provider or organisation to find out the differences from this guide. Throughout the text in this publication, you will notice the following special notations used to highlight certain information or items:

Example	Description
	Key presses are shown as a key symbol.
 2 2	Use alphanumeric keys as shortcuts to reach the required sub-menus. In this example, press    in sequence, not simultaneously.
3 ✓Voice Only	Indicates the active setting.
Status Sent	Information appearing on the MTM800 display are shown in special print.
6 <User Defined>	Indicates a prompt or message configured by your Service Provider

Controls and Indicators

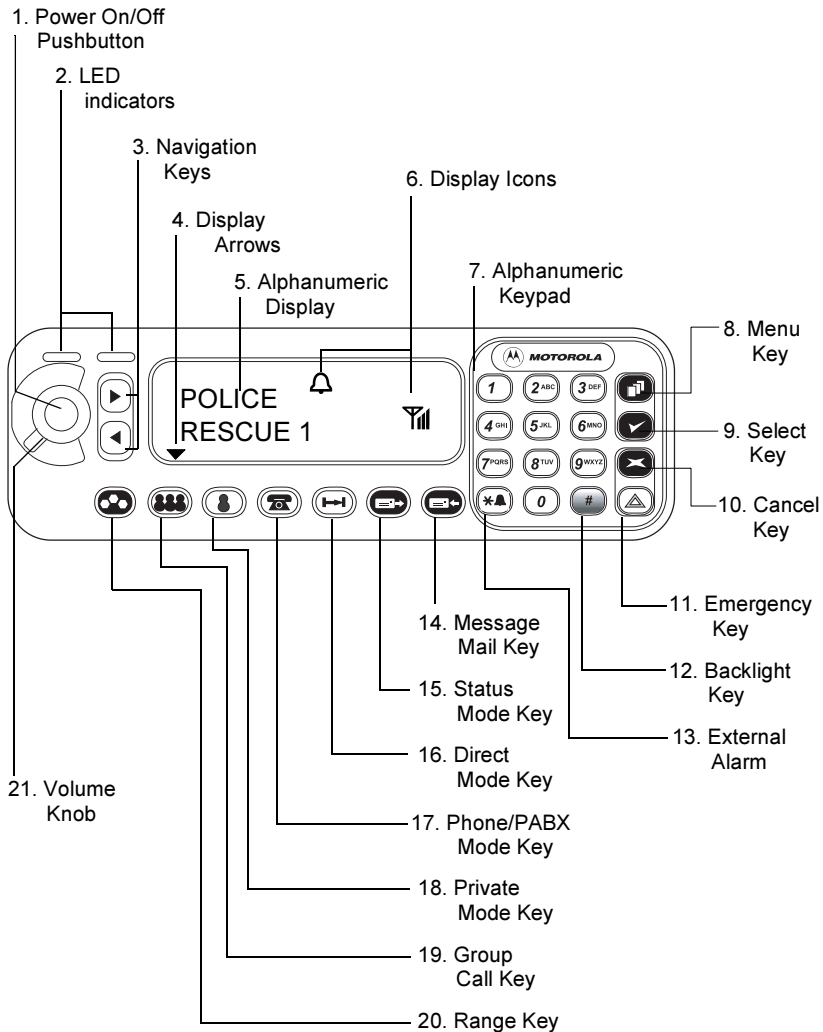







Item	Description
1	On/Off Pushbutton Turns the MTM800 on and off. (See page 11.)
2	LED Indicators Indicate the service state.(See page 11.)
3	Navigation Keys Press to move up or down through options and lists, such as message or phone address book lists.
4	Display Arrows When relevant, point to keys located below the alphanumeric display, indicating the present mode. (See “Examples of MTM800 Mode Start Screens” on page 14.)
5	Alphanumeric Display Backlit view of two lines of characters or digits (up to 14 characters or digits per line).
6	Display Icons Show additional information and MTM800 status. (See page 9.)
7	Alphanumeric Keypad Enter numbers and alphabetic characters. (See page 15.) The function of these keys is programmable by the Service Provider. (See page 18.)
8	Menu Key Press to bring up menu options. Use navigation keys to scroll. (See page 14.)
9	Select Key Press to select the displayed option or to confirm an entry.
10	Cancel Key Press to cancel/clear/exit the current activity or entry.
11	Emergency Key Initiates Emergency mode and sends Emergency Alarms. (See page 15.)
12	Backlight Key Dims and intensifies the radio’s backlight (four intensity options). (See page 26.)
13	External Alarm Key Used to activate and deactivate the External Alarm (Horn & Lights). (See page 26.)





Item	Description
14	Message Mail Key Selects the Message Mail mode of operation. (See page 98.)
15	Status Mode Key Selects the Send Status mode of operation. (See page 97.)
16	Direct Mode Key Enters/Exits Direct Mode Operation (DMO). (See page 44.)
17	Phone Mode Key Selects the Phone/PABX Call modes of operation. (See page 54.)
18	Private Mode Key Selects the Private Call mode of operation. (See page 49.)
19	Group Call Key Selects the Group Call mode of operation. (See page 33.)
20	Range Key Selects the talkgroup range (used before selecting a talkgroup). (See page 32.)
21	Volume Knob Adjusts the volume level. (See page 26.)
	Push-To-Talk (PTT) Button Push to: <ul style="list-style-type: none"> • Send a Group, Private, Phone/PABX, or Emergency Call. • Send a status message.

The Display

Icons

After you turn on your MTM800, icons appear along the top of the display to indicate the following conditions:

Icon	Description
	<p>Signal Strength (TMO) Allows you to check signal strength before proceeding with a call. Six bars indicate the strongest signal. Calls and messages may not be sent or received in weak signal areas. A blinking antenna shows out-of-coverage. Move to a location that indicates better coverage and reattempt the call. The antenna is not shown in Direct Mode Group Call.</p>
	<p>Signal Strength (DMO) Indicates an incoming Direct Mode Group Call.</p>
	<p>Direct Mode Displayed when the terminal is in Direct mode.</p>
	<p>DMO Gateway Indicates that you selected to work with gateway. This icon has three positions: Solid — while the terminal is synchronised with the gateway (i.e., when the terminal receives a presence signal). Blinking — while the terminal is not synchronised with the gateway or during attachment. No icon — during a terminal to terminal and repeater call.</p>
	<p>DMO Repeater Displayed when the repeater option in DMO is selected. This icon has three states: Solid — while the terminal has detected the repeater (i.e., when the terminal receives a presence signal). Blinking — while the terminal has not detected the repeater or during attachment. No icon — during a terminal to terminal and gateway call.</p>
	<p>New Message Received Indicates that you have new messages in your mail box.</p>
	<p>External Alarm Displayed when External Alarm (“Horn & Lights”) is enabled.</p>

Icon	Description
	Incoming Private Call Flashes to indicate an incoming Private Call. The icon extinguishes if you accept or reject the incoming call or if the call setup fails.
	Phone Call Flashes when a Phone Call is received.
	Emergency Appears while the MTM800 is in Emergency mode. The icon flashes to indicate an incoming Emergency Group Call.
	Priority Scan (with Priority Monitor Dot) Indicates scanning is activated.
	Data Connected Displayed when the MTM800 is successfully connected to the external device (laptop or desktop PC) and ready for data transfer. Receiving/Transmitting Data: The icon indicates that data transfer is currently taking place.

Displaying Long Numbers

Three dots after the number indicate that it continues on the next page (for example, in the phone address book).

Phone Mode
1234567891234...

If you dial a long number, each new digit entered will shift the displayed number left by one digit.

Displaying Long Text Messages

An arrow after the text message indicate that it continues on the next page (for example, when reading a mail message). Press  to read the next page.

Call David at
home urgent ▶

LED Status Indicators

The LED indicators shows the in-service status of your MTM800.

Indicator	Status
GREEN: Solid	In use
GREEN: Blinking	In service
RED: Solid	Out of service
RED: Blinking	Connecting to a network / Entering DMO
AMBER: Solid	Transmit Inhibit (TXI) in service / Channel busy in DMO
AMBER: Blinking	Incoming call
No indication	Switched off

Powering On/Off

To power on:

- Press the **On/Off** pushbutton.
- If the MTM800 is configured with ignition sense, the radio will automatically turn on whenever the vehicle ignition is turned on.
- If an external Emergency Switch is connected to the accessory connector and “Emergency with wake up” is enabled by your Service Provider, the MTM800 automatically turns on in Emergency Mode whenever the Emergency Switch is pressed (see “Emergency Mode” on page 58).

A set of icons and squares will appear on your display. (See “Icons” on page 9.) Then your MTM800 performs a self-check and system registration routine. The display shows additional information while the MTM800 is registering on the system.

After successful registration, the MTM800 will be in service.

To power off:

- Press the **On/Off** pushbutton again.
- If the radio is powered on via the ignition, it can be turned off via the ignition or the **On/Off** pushbutton

You will see the **Powering Off** message.

NOTE

The terminal powers On and Off without visible and audible notification if Covert Mode is activated. (Refer to “Covert Mode” on page 24.)

Uninstalling the Radio



CAUTION

OPTION 1:

Before disconnecting the 13.2V main power supply from the radio:

1. Switch off the radio.
2. Wait for a minimum of 4 seconds after the radio Off Switch is released.

Disconnect the 13.2V main power supply.

OPTION 2:

Turn off the main power supply **WITHOUT** switching OFF the radio.

Unlocking the MTM800

Your MTM800 may be locked at power up. To unlock, see “How to unblock the MTM800” on page 76.

Selecting Your Network

Before you start operating your MTM800, you can select the network you want your MTM800 to be registered to. For detailed information, see “Network” on page 88.

Powering On with activated Transmit Inhibit

If the terminal has been powered Off with activated Transmit Inhibit (see “Setting Transmit Inhibit (TXI) Mode” on page 89) the TXI Mode remains active.

When powering On with activated TXI Mode the user will be asked whether to leave the TXI Mode or not.

- 1 Exit TXI
- 2 Stay In TXI

Press **1** if you want to deactivate the TXI Mode — e.g. if you have left the RF sensitive area where the TXI Mode was recommended. If the MTM800 was previously used in Trunked Mode (TMO), it will register to the network.

If you press **1**, and the terminal was previously used in TXI and Direct Mode, it will exit TXI Mode and remain in Direct Mode.

If the terminal was previously in Trunked Mode with TXI enabled, pressing **2ABC** will power off the terminal.

If you press **2ABC**, and the terminal was previously used in TXI and Direct Mode, it will remain in TXI and Direct Mode.

Key Overview

The Mode Keys

The MTM800 has four major call modes when operating in Trunked Mode:

- Group mode — to send and receive Group Calls.
- Private mode — to send and receive Private Calls.
- Phone mode — to send and receive Phone Calls.
- PABX mode — to send and receive local (office) extension numbers calls.

NOTE *PABX mode will only be displayed if enabled by your Service Provider*

If configured by your Service Provider, Group mode is the home mode to which the MTM800 returns automatically when there is no activity for a few seconds in another mode or in the menu.

Group mode can operate either in

- In **Trunked Mode Operation** (TMO) the MTM800 is used with the infrastructure services within system coverage, or
- In **Direct Mode Operation** (DMO) the MTM800 is used without infrastructure services required.

NOTE

While operating in DMO mode the propagation travels directly from the transmitting terminal antenna to the receiving terminal antenna, with no assistance from any base station or tower. Therefore, the range is critically dependent on the position of the motorcycle. Any obstructions (hills, buildings, etc.) between the TETRA terminal users will further decrease the range. Conversely, moving the motorcycle to another or higher location may improve the range.

A terminal in DMO can communicate with the trunking system (and vice-versa) through a gateway device. To use that feature, please enable the gateway option in your terminal (see “Gateway/Repeater Selection” on page 41).

NOTE

It is only possible to place group and emergency group calls in DMO.

Press the  key to enter Direct Mode Operation.

Your display appears similar to the following default start screens for the Group, Private, Phone/PABX modes when your MTM800 is in service.

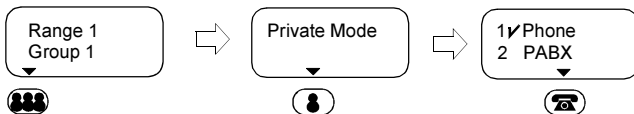
Examples of MTM800 Mode Start Screens**The Menu Key**

Your MTM800 contains menus and sub-menus. They allow you to adapt a large number of settings to your needs.

A menu is a list of options. Some of these options provide access to a further list of options called a sub-menu.

The example below shows how to check the available free memory in the phone address book. The ✓ sign indicates the selected option



The menus are organised in a hierarchy (see “List of Menu Options” on page 70) for easy access and fast navigation between options. Numbers can be used as shortcuts. In the example above, you can reach the second sub-menu by pressing  2 1 4 in sequence (not simultaneously). For information on using the alphanumeric keys, see “The Keypad” below.

If there are more than two options in a specific sub-menu, the last option appears in the first line of the initial display, letting you know how many options are available.

The Emergency Key

The Emergency mode, that you can start from any mode by pressing the  key, enables you to send Emergency Alarms and initiate Emergency Group Calls.

NOTE

Emergency mode is available in Trunked Mode and Direct Mode Operations. Emergency Alarm is a feature of Trunked Mode Operation only. The Emergency Alarm will be send to the dispatcher (if configured by your Service Provider).

NOTE

The required time you need to press the Emergency key is by default set to 0.5 seconds. The time can be configured by your Service Provider.

However, you will be able to receive or transmit emergency calls even when the MTM800 is locked with pin protect.

The Alphanumeric Keypad

Use the keypad for dialling, entering number into the address book, or creating SDS (Short Data Service) messages, or for one-touch dialling.

Entering Numbers







To enter a number in the address book, press the corresponding number key.

Entering Text (Letters and Digits)

To enter alias text in an address book or text in messages, press the key labelled with the desired character, once for the first character, twice for the second, and so on. The key has additional characters (see page 17).

For information on alias text, see the chapter below.

Editing the Text

To...	Action
Move the cursor one character to the right	Press  , press a new key, or wait for a short time
Move the cursor from the end of the text to its beginning	Press and hold 
Move the cursor to a character on the left	Press 
Delete a character left to the cursor position	Press 
Delete the whole text	Press and hold 
Quit editing	Press 

Aliases (Names)

Aliases are optional names that you can assign to stored phone and private numbers (or IDs).

Aliases can be up to 14 characters in length and may consist of letters, numbers, or spaces.

Aliases are displayed during memory list scrolling. Aliases are also used to retrieve numbers from your memory list.

The following screens show examples of how the caller's private number can be displayed.

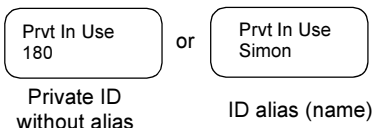

Available Characters

Press the appropriate keys to display the characters listed in the table below.

The top line for each key shows the upper case characters, and the lower line shows the lower case.

Press and hold **#** to toggle between upper and lower case.

List of Available Characters:

Key	Alphanumerics
1	, . ? ! 0 1 @ ' " - () / : _ ; + & % * * = < > € £ \$ ¥ α [] { } \ ~ ^ ` ¡ ¢ § #
2 ABC	A B C 2 Ä Å Æ Ç a b c 2 ä å æ ç
3 DEF	D E F 3 È É Ê Ë d e f 3 è é ë ê
4 GHI	G H I 4 Î Ï Ì g h i 4 î ï ì
5 JKL	J K L 5 j k l 5
6 MNO	M N O 6 Ö Ó Ò Ñ m n o 6 ö ó ò ñ
7 PQRS	P Q R S 7 p q r s 7
8 TUV	T U V 8 Ü Ù Ú Û t u v 8 ü ù ú û
9 WXYZ	W X Y Z 9 w x y z 9
* / %	Space * / %
0	0 + -
#	# = < >

Programmable Keys

Your MTM800 supports the one-touch feature that allows you to select/activate commonly used features by pressing and holding a numeric key. Your Service Provider should program the numeric keys with the relevant features. All the numeric keys on the keypad are programmable. The following table lists the programmable features and their availability in specific MTM800 states/modes. For detailed information on the features, see the relevant section in the user guide:

Feature	Description
Talkgroup Switch	Switch to a specific talkgroup
Talkgroup Scan	Enables/disables the Talkgroup Scan function. (TMO only)
Status Message	Sends a dedicated status message to a dedicated address. (TMO only)
Speaker on/off	Directs voice audio to the earpiece of the headset or to the external speaker.
Call dial (Private, Phone, PABX)	Initiates a call to a predefined entry in the address book.
Transmit Inhibit (TXI)	Toggles between activated and deactivated TXI mode.
Covert Mode	Toggles on/off covert mode

NOTE

If the one-touch feature is enabled, one-touch dial is disabled (see page 55).

To use the one-touch feature:

- From any mode, press and hold the required numeric key for a few seconds.
- Your MTM800 will display the number or function and act according to the programmed feature.

One-touch Private Call is set by the Service Provider.

1. If it is set to **Simplex**, then outgoing Private Call is Simplex too.

2. If it is set to **Duplex**, then outgoing Private Call can be duplex in TMO, Simplex in DMO with the last Group Call Originator number.
3. If it is set to **Duplex**, then outgoing Private Call can be duplex in TMO and cannot be initiated in DMO when the phone book index is required.

Home Mode Display

Your MTM800 is provided with a feature that allows your Service Provider to send special text messages to your MTM800 display.

The message is displayed when your MTM800 is inactive.

Range 1
<HomeModeTxt>

The message will stay on your MTM800 display until a new message is received.

If configured by your Service Provider, your MTM800 will display an internal Home Mode Display until another message is received.

Terminal Disable/Enable

Your MTM800 is provided with a feature that allows your Service Provider to disable it temporarily (in case it is stolen or lost) wireless.

During the time your MTM800 is disabled, no calls can be initiated or received.

While your MTM800 is disabled, it will display the following blank screen.

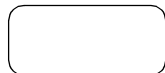

Your MTM800 will act like it is turned off.

If you try to turn your MTM800 on when it is disabled it will operate as described above.

If your MTM800 is found, your Service Provider can re-enable it. After your MTM800 is re-enabled, you may resume normal operation.

Terminal Permanent Disable



Your MTM800 is provided with a feature that allows your Service Provider to disable it permanently in case it is stolen or lost. When your MTM800 is disabled permanently, it becomes inoperable.

After a Permanent Disable the MTM800 can not be re-enabled by your Service Provider.

You are recommended to disable your MTM800 permanently only when you do not expect the terminal to be recoverable any more.



Making Calls

You are ready to place the call as required for the mode you are in:

- press  to initiate the call and  to end the call.
- press and hold the **PTT** while talking, and release the **PTT** while listening.

To dial a number for an outgoing call, enter the required mode (Group, Private, Phone, or PABX) and use one of the methods described on the following pages.

For more details on mode specific dialling methods, see the relevant mode section in this guide.

Since the same numbers can be used in different modes for various subscribers (if configured), be sure to make the calls from the correct mode when entering a number through the keypad. Pressing  or  while dialing a number will carry the number typed to the next mode.

VOX Control

VOX (Voice Operating Transmission) allows the user to transmit voice in a hands-free condition. It is detecting audio automatically when full duplex private call and telephone call use the first microphone.

NOTE *This feature is only available if set up by your Service Provider. If it is disabled, transmission can start upon pressing PTT.*

Receiving Calls

The MTM800 will automatically switch to the mode of the incoming call. After the incoming call ends, the display returns automatically to the mode it was in before the incoming call arrived.

NOTE *In Private, Phone and PABX modes on receiving not Emergency TMO or DMO group call the MTM800 stays in the current mode. You can hear the call and the display remains unchanged.*

Your MTM800 will alert you of an incoming call depending on the setting you selected in Tones menu option (see page 85). During message editing, you will be alerted of an incoming Group/Emergency Group/Broadcast Group Call if configured by your Service Provider.

Busy User Pre-emption (BUP)

NOTE *This feature is only available if set up by your Service Provider.*

A console operator in the system might wish to call you while you are in an on-going call (Private, Phone, PABX). The console operator will activate the BUP feature to interrupt and pre-empt your call.

NOTE *BUP Invocation also pre-empts a call in process of being set up. The call in setup must be a private, phone or PABX call.*

The console operator will then try to set up a private call with you, within a pre-determined period of time after successful call pre-emption.

NOTE *Only emergency calls are allowed within a pre-determined period of time after successful call pre-emption (during BUP wait state).*

Pre-emptive Calling (PPC)

Pre-emptive calling is particularly useful when you need to speak urgently with a user whose terminal is busy in a non-emergency voice call.

A Pre-emptive Priority call (PPC) is either an Emergency Group Call or a Private PPC (half-duplex or full-duplex call).

The feature allows to disconnect the on-going lower priority call to connect to the incoming higher priority call.

The Service Provider configures the priority of the PPC. Its highest priority is emergency priority.

To place a PPC, see the Emergency mode and Private mode sections in the user guide.

The MTM800 will receive the call via loudspeaker or earpiece of the handset, according to the setting used when the PPC is received

NOTE For call alert, see settings in the Tones menu option (page 85).

Receiving a PPC is explained in the following paragraphs.

In the following screens **<Any> in Use** refers to any of the non-emergency voice calls: Group, Private, Phone, or PABX.

Receiving an Emergency Group Call during a Call

The MTM800 receives the Emergency Group Call, drops the on-going non-emergency voice call, and connects to the Emergency Group Call.

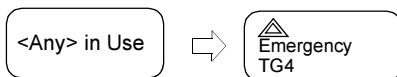

Receiving a Private PPC during a Call

If configured by your Service Provider, the MTM800 receives the PPC, drops the on-going, non-emergency, lower priority voice call, and connects to the higher priority private call.

A PPC with lower or equal priority, will be dropped without any indication to the called user and will enter the missed call list.

A PPC with emergency call priority will be displayed on the screen as **Emergency** (instead of **Priority**).

Half-duplex Private PPC Received

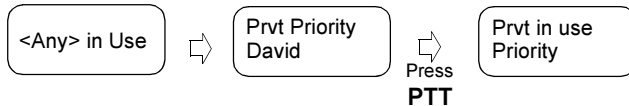

Full-duplex Private PPC Received

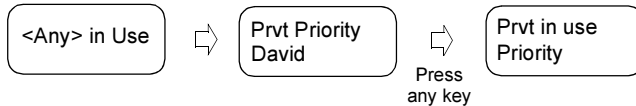

Broadcast Call

The Broadcast Group Call (also called Site Wide Call) is a high-priority group call from the console operator (or dispatcher) to all terminal users located at one or more sites.

Group In Use
Broadcast

The terminals are configured to monitor a Broadcast Call, but the users cannot talk back.

The call can be received as normal broadcast call or emergency broadcast Call.

Emgcy In Use
Broadcast

The Broadcast Call pre-empts an on-going Group Call that has the same (or lower) call priority.

For selecting a talkgroup during a broadcast call, see "Selecting a Talkgroup" on page 29. For changing range during a broadcast call see "Selecting a Range" on page 32.

Ambience Listening (AL)

This feature, if enabled by your Service Provider, allows a console operator or dispatcher to establish a special call with a specific MTM800 to monitor voice activity in the local vicinity. The call is setup without any indication to the affected MTM800, and any lower priority ongoing voice call or packet data transfer may be pre-empted.

After accepting the call, the MTM800 transmits in a half-duplex Private call without any action from or indication to the user. The Ambience Listening call shall automatically end when the user initiates any voice call and uses the terminal normally.

Canceling an Incoming Call

In all modes (except Group), if you wish to cancel a call during an active call, press . The call number will be forwarded to the Missed Call list.

Covert Mode

If configured by your Service Provider the Covert Mode gives to you the ability to completely shut down all visible and audible MTM800 alerts and notifications. This feature makes the MTM800 effectively unnoticeable even in a silent and dark environment.

To Enter the Covert Mode:

- Press the Cover Mode one-touch button (if programmed by your Service Provider).
- Select Covert Mode in the Security menu (refer to page 80).

Local Area Service

This mode, which is also called Fallback Mode, allows more than one user from the same site to communicate when the link between the site and network central controller fails.

Entering and exiting Local Area Service (that is, returning to System Wide Services) is done automatically.

Entering Local Area Service

When the MTM800 receives a Local Area Service indication from the system, the following occurs:

- the MTM800 sounds a tone.
- the display shows the “Local Area Service” message.
- any call in progress is dropped upon entering Local Area Service mode.

If configured by your service provider, this message/alert will periodically reappear to remind you the terminal is still operating in Local Area Service mode.

The following features are available while the MTM800 is in Local Area Service:

- Registration
- Attachment
- Group Call
- Emergency Group Call
- Emergency Alarm

Exiting Local Area Service

When the link with the central network controller is re-established, the MTM800 exits Local Area Service and the following occurs:

- the MTM800 sounds a tone.
- any call in progress during Local Area Service is dropped.

Dimming the Display

If the backlight is set to Manual (see “Setting Backlight” on page 82), there are four levels of display backlight intensity. To change the backlight intensity, press .

NOTE

The intensity cannot be dimmed in Phone or PABX Mode and text editing, where the Backlight key () is used to enter a # sign and/or as a Shift key.

Adjusting the Volume

To increase the volume, turn the On/Off-Volume knob clockwise.

To decrease the volume, turn the On/Off-Volume knob counter-clockwise.

Horn & Lights Alarm On/Off

Use the Horn & Lights Alarm when you leave your motorcycle and want to be alerted if an important message arrives (Private Call, for example).

NOTE

In order to operate the Horn & Lights Alarm, you must install the GKN6272 accessory on your motorcycle.

If the External Alarm function is pre-programmed, the motorcycle lights turn on and an alarm sounds to inform you of the incoming call.

To turn the Horn & Lights Alarm on or off, press .

NOTE

*The ignition must be off for the Horn & Lights Alarm to work. The Horn & Lights Alarm cannot be operated in Phone or PABX Mode and text editing, where the  key is used to enter an * sign.*

Packet Data

The Packet Data (PD) Service allows you to transfer data in a TETRA system using the Internet Protocol (IP). Check with your Service Provider for the availability of this feature.

NOTE

For transferring data from a standard computer over the air connect the computer via the Active Data Cable GMKN1022 with your MTM800. Your Service Provider has to setup additional applications on your computer.

If set up by your Service Provider it is possible to accelerate the transmission by using the Multi Slot Packed Data (MSPD) Service (refer to “Packet Data” on page 93).

Looking after your MTM800

To clean your MTM800, use a moistened or antistatic cloth. **DO NOT** use a dry or electrostatically charged cloth.

TMO Group Call

General

A Group Call is an instant communication between you and others in a talkgroup that you select. Participants may join (late entry) and leave an on-going Group Call. A **talkgroup** is a predefined set of subscribers enabled to participate in and/or invoke a Group Call and set up by your Service Provider.

Talkgroups appear on your display as names or numbers (for example: Sales, Service, Electricians, Talkgrp10).

The Talkgroups are divided into **ranges**. Each range may contain up to 16 talkgroups.

For ease of use, your MTM800 also provides the ability to:

- Perform an alphabetical search of the talkgroup aliases.
- Scroll through the entire talkgroup list using the navigation key.
- Dial a talkgroup (set up by your Service Provider).
- Organise your favourite talkgroups into one range called My Groups (set up by your Service Provider).

Your talkgroups may be organized into **scan lists** (set up by your Service Provider, or by yourself through the Menu).

When you activate one of these scan lists, your MTM800 will continuously monitor the activities of the selected talkgroups.

By assigning priorities to the talkgroups defined in the scan list, you will be capable of accepting calls that have higher **priority** than the on-going call. For detailed information on scanning, see page 90.

You can start talkgroup, range, or scanning selection when the terminal is in idle mode or receiving a call.

While being in a call and dialling another group simultaneously, do the following to talk in the current call:

1. Exit selection screen.
2. Press **PTT** and start talking.

Pressing **PTT** on selection screen switches to a new group and starts a call.

Each talkgroup may have one associated **Announcement Talkgroup** (ATG) that it monitors (If set up by your Service Provider).

An ATG is a special group which is linked to a number of talkgroups and has the highest priority level, thus enabling broadcast of the call to all these talkgroups.

When an ATG is selected, the scanning icon is not displayed. The MTM800 monitors the ATG scan list instead of the selected scan list. The ATG scan list contains all the talkgroups associated with a selected ATG. Your Service Provider should advise what talkgroups are associated with which Announcement Talkgroup.

Your MTM800 will always monitor the group calls in the ATG scan list. To place an Announcement Call, you must first select the specified Announcement Talkgroup as advised by your Service Provider, otherwise you will only be able to participate when an Announcement Talkgroup is received.

Activation and deactivation of talkgroup scanning has no effect on the ATG scan list.

Selecting a Talkgroup

You can select a talkgroup in one of the following ways, by using the:

- navigation keys
- alphabetical search feature
- numeric keypad entry (if configured by your Service Provider)
- favourite groups (if configured by your Service Provider)

Range 10
Talkgroup 1



For talkgroup range scrolling configuration, see note in “Selecting a Range” on page 32.

Using the Navigation Key

Your Service Provider configures the MTM800 to display only selectable talkgroups. Press the navigation key to scroll to the required talkgroup and press . For talkgroup range scrolling configuration, see note in “Selecting a Range” below.

Range 10
Talkgroup 2

Using Alphabetical Search

1. In Group Mode, press .
2. Select **abc** for talkgroup alpha search and press .
3. You are now at the talkgroup alpha search screen. Enter an alphanumeric digit, and the MTM800 starts searching for the first Talkgroup alias, that starts with that character. Use the navigation key to scroll to adjacent aliases. In this example “a” is entered.
4. Scroll and select the desired talkgroup by pressing , or press **PTT** to select and start a call on the new group.

Range 1
TG 4

5 View Speed#
1/abc

abc: Group

A = A team
3500

Using the Numeric Keypad

When the terminal is in group mode and not transmitting (i.e., idle or receiving a call), you can dial a group by entering its speed number via the keypad. This feature is called talkgroup speed dialling. The speed number is pre-configured in the terminal.

You can also view a speed number attributed to a group, if it exists.

Viewing the speed number of an attached group

1. In Group Mode, press .

Range 10
Talkgroup 1

2. Select **View Speed#** to view the talkgroup speed number.

4 Add to MyGrp
5 ✓View Speed#

3. In this example “1” is the speed number.
Press  to return to the attached group screen.

Range 10
1*=Talkgroup 1

Viewing the speed number while in scroll (idle mode only)

1. In Group Mode, press the navigation key to scroll to the required talkgroup.

Range 10
Talkgroup 1

2. Press .

Range 10 ←
Talkgroup 2

3. Select **View Speed#** and press  to view the talkgroup speed number.

5 ✓View Speed#
1 abc

4. In this example “2” is the speed number.
Press  to return to the attached group screen.

Range 10
2*=Talkgroup 2

Dialling a speed number

1. Enter a number (for example: “2”).

Range 10
Talkgroup 1

2. Press  or .

Range 10
2

3. Press  to attach the new group, or press **PTT** to attach and call.

Range 10
2*=Talkgroup 2

Favourite TalkGroups

This feature allows you to store a favourite group in a special range called **My Groups**. A stored group may be TMO or DMO.

You can do the storing

- from the group mode screen or
- from the My Groups menu option.

Adding a Group from the Group Mode Screen

1. In the group mode screen scroll to the required group and press .
2. Select **Add To MyGrp**.

Range 10
Talkgroup 1

4 ✓ Add to MyGrp
5 View Speed#

The terminal displays the talkgroup alias added message and then returns to idle state.

TG 101
added

Adding a Group from the My Groups menu option

See “My Groups” on page 74.

Selecting a Group from the My Groups Range

See “My Groups” on page 74.

Changing a Talkgroup during/on receiving a call

You can select a group folder without an interruption on receiving and during a call.

Selecting a group on receiving a call

If you select a group and a non-Emergency call is incoming, MTM800 display remains unchanged while you hear the call.

During the selection you cannot see calling party information.

NOTE



When an Emergency Call is received, then selecting is aborted, the MTM800 switches to the group mode and Emgcy In Use display appears.

Selecting a group during a call

If you start selecting a group during a call, **Group In Use** or **Emgcy In Use** display disappears.

Selecting a Range

To select a range:

1. Press , Select the **Range** option.
2. Use  or  to scroll through the ranges.

2 ✓ Range
3 Scanning

3. Press  to confirm your selection (or **PTT** to start the call in the new range).

NOTE

The Service provider can configure range scrolling to:

- *Stay in range* — when the range end is reached during talkgroup scrolling, further scrolling restarts the range talkgroup list.
- *Scroll to next range* — when the range end is reached during talkgroup scrolling, further scrolling switches to the talkgroup list in the next range.

Activating/deactivating Scanning

See “Setting Talkgroup Scanning” on page 90.

Making a Group Call



1. Press .

You are now in Group mode. In this example, “Range 3” is the last selected range. “Service” is the last selected talkgroup.



Range 3
Service

2. If this is the required talkgroup and range, press the **PTT**. Wait for the “Talk permit” tone (if configured) and then speak into the microphone.

*Release the **PTT** button to listen.*

3. To select a talkgroup other than the one shown, press  or  to scroll through the talkgroups. Press  to confirm your selection.

*Press **PTT** to start the call in the new talkgroup.*

4. To select a range other than the one shown, press , select the **Range** option, use  or  to scroll.

*Press  to confirm your selection (or **PTT** to start the call in the new range). The call is set up in the new range and last selected talkgroup in this range.*

When you start a call, members of the selected talkgroup who have their units turned on, will receive the transmission.

NOTE

The 'No Group' message is displayed when you are out of the normal coverage area of your selected talkgroup. If so, select a new talkgroup that is valid for your working location.

Receiving a Group Call

Unless it is engaged in an active call, your MTM800 will automatically switch to Group Mode and receive the transmission. To answer the call, press and hold **PTT**.

Your MTM800 shows the Group Name, and the caller's private number or name (alias) if previously stored in your address book. In case a favourite talkgroup is received, the terminal will display the "My Groups" range and group alias.

The following screens show examples of how the caller's private number (ID 124) is displayed.

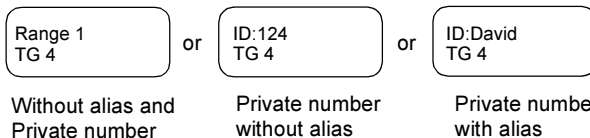

NOTE

For incoming call alert, see settings in the Tones menu option (page 85)

NOTE

When receiving a Group Call, your MTM800 will sound a "New Group Call" tone (if configured by your Service Provider).

Receiving a Group Call with Scan Off

You can receive a group call from the selected talkgroup or from the associated ATG only.

Receiving a Group Call in Idle Mode

In Automatic Mode Switch you can receive a Group Call in any mode. Your MTM800 will automatically switch into Group mode and receive the transmission.

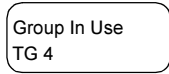

Receiving a Group Call during an On-going Group Call

Depending on how your Service Provider has configured incoming calls, the incoming call will either be:

- Forced upon you and will interrupt the ongoing call (if the incoming call has higher priority than the ongoing call).
- or
- Presented to you (if it has higher priority than the on-going call).

To accept the call, press , and press the **PTT** button.

ID: 124
Talkgroup 7

Receiving a Group Call with Scan On

With Scan On, you can receive a group call from the scan list you set up, in addition to receiving a group call from the selected talkgroup or from the associated ATG.

Receiving the scan call functions as receiving an associated ATG or selected call in scan off (see previous page), except for the following:

ID: 124
Talkgroup 7

- The display is different when receiving the call in idle mode, as shown here.
- The MTM800 sounds a tone as explained in the note below.

NOTE

When receiving a High Priority Group Call, your MTM800 will sound a "High Priority Group Call" tone (if configured by your Service Provider).

NOTE

When receiving a Group Call from your scan list, which is not from a high priority group, your MTM800 will sound "New Group Call" tone (if configured by your Service Provider).

Receiving an Emergency Group Call

For detailed information, see page 22.

Receiving a Broadcast Call

For detailed information, see page 23.

Transmit Inhibit

The Transmit Inhibit (TXI) Mode can be activated by the user before he enters RF sensitive areas, e.g. hospitals or in potentially explosive areas, where safety can be jeopardized due to terminal transmission radiation.

NOTE *Radiation of the MTM800 is only suppressed if the TXI Mode is activated or the terminal is separated from power supply.*

Transmit Inhibit can only be activated in Group Mode. In Transmit Inhibit Mode the terminal will not transmit under any circumstances, except for the Emergency Group Call, which can be initiated even if the MTM800 is in TXI Mode.

All terminal functions and keys which cause transmission, e.g. registration to the network, change of talkgroup or range, sending messages, pressing **PTT**, etc. are disabled. In this case the display shows “Not Allowed In TXI Mode” and the terminal sounds the “Transmit Inhibit” tone.

When no danger to safety exists anymore (for instance if the user leaves the RF sensitive area) the Transmit Inhibit mode can be deactivated and the terminal returns to normal operation.

Setting the TXI Mode is described in “Setting Transmit Inhibit (TXI) Mode” on page 89.

NOTE *To activate or deactivate the TXI Mode you can use one of the programmable keys (if set up by your Service Provider). You must press and hold the key for a pre-set time as configured by your Service Provider.*

Activated Transmit Inhibit is indicated by the solid amber LED and changing between the two displays:

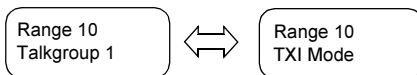

Dynamic Group Number Assignment (DGNA)

DGNA provides the ability for a network operator or authorised user to dynamically allocate new, or update existing talkgroups to selected terminals over the air interface. Using supplementary services messages (SS-DGNA), the network operator can command the terminal to add talkgroups to the existing talkgroups list, or to delete talkgroups from the list. This operation is performed by transmitting the data into your MTM800.

NOTE

Your Service Provider can gather some Talkgroups under one Super-group and transmit it to your MTM800 as a DGNA. In such a case, you will be able to participate in calls to/from all the groups in the Super-group.

DGNA Reception with Notification Message

When a DGNA is received and DGNA notification was configured by your Service Provider, you will get a tone indication and notification message (“Programming Entries...”), and then a display of the new assignments.

6 TG Added

If DGNA notification was not configured by your Service Provider, you will only get a tone indication and only if a selected group was changed by the DGNA.

1. To view the added/deleted talkgroups details press . You may scroll through the list using the , keys.
2. To return to the initial Mode display press .
3. To select the DGNA group, press . Or scroll to another group using the navigation key, and press .

A: <name1>
<range>

NOTE

Once you exit the DGNA notification screen, the Select key disappears. To select one of the newly added groups, see page 29.

If configured, a newly added group will be automatically attached as the selected group and will replace the currently selected group. If the group is later removed, the terminal reselects the last selected group prior to receiving the automatic attachment.

If configured, a newly added group will also become the newly selected talkgroup.

If this group is de-assigned, and no group changes or power cycling have occurred, the terminal will revert to its previous talkgroup.

If a new DGNA is received during scrolling, you will receive a message, indicating that the list of talkgroups was updated.



TG list
Updated

After a few seconds the display returns to the initial DGNA display detailing the update:



18 TG Removed

If the DGNA received is an all "Talkgroups delete" assignment, your MTM800 will display the following:



All TalkGroups
Deleted

DGNA Reception without Notification Message

If DGNA notification was not configured by your Service Provider, you will get a tone indication and notification message only and only if a selected group was changed by the DGNA.

DGNA Auto Select Group

If DGNA Auto Select was configured by your Service Provider, whenever a DGNA message is received by your terminal, the talkgroup will automatically be made the selected group by your terminal.

Button/Footswitch

This feature provides to the user ability to send provisioned status message by pressing Emergency button/footswitch.

TMO Emergency mode, Emergency Alarm and initiating TMO Emergency Group/Private call is unavailable.

Message addressing and sending:

- address can be predefined by Service Provider if not it will be send to currently selected group
- if no group selected the message will be send to reserved address
- message will be send even if the user is involved in any active service.

Indication depend on Service Provider. Visible/audible can be disabled for the status message.

When the radio is PIN locked the user can still press the Emergency button/footswitch to send the message. If the radio is out of service the user will only see indication that operation failed.

DMO Group Call

General

In DMO (Direct Mode Operation) the MTM800 can be used without your Service Provider's infrastructure.

Direct Mode allows communication among terminals in which the same talkgroup is selected.

NOTE

In DMO it is only possible to place Group Calls, Emergency Group Calls and Private Half-duplex Calls.

You can receive a call:

- From the selected talkgroup
- From other users within talkback range (if configured by your Service Provider). This is called an InterMNI (Mobile Network identity) call.
- From an open group. (An open group is a super-group to which all DMO groups belong.)

When you start a call, the members of the selected talkgroup who have their units turned on, and are within the group subscriber identity (as configured by the Service Provider), will receive the transmission.

In DMO the MTM800 can communicate with the trunking system (and vice-versa) if the **Gateway** option is enabled in the terminal.

To enhance the terminal's DMO coverage area the DMO group can link to a repeater if the **Repeater** option is enabled in the terminal. Additionally the **GW + Rep** (gateway and repeater) communication mode can be used.

If Transmit Inhibit is activated while the terminal is set to DMO, the PTT is disabled. You can only listen. For detailed information on Transmit Inhibit, see page 36. DMO Talkgroup selection is allowed when Transmit Inhibit is activated.

Selecting a Talkgroup



See “Selecting a Talkgroup” on page 29.

Changing a Talkgroup during/on receiving a call

See “Changing a Talkgroup during/on receiving a call” on page 32.

Switching from TMO to DMO or from DMO to TMO

Enter TMO or DMO in one of the following ways:

- To switch from TMO to DMO press and hold .
- To switch from DMO to TMO press and hold .

Gateway/Repeater Selection

Use the DMO **Config** sub-menu for setting the Gateway and Repeater options.

1. Press  to enter the options menu in DMO:

DMO Options Sub-menu

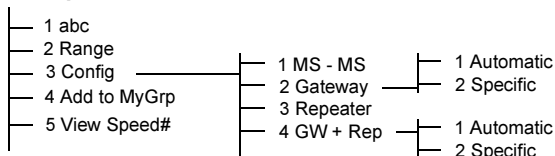

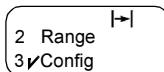
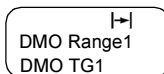

2. Scroll to **3 Config**, and press **Ok**.



Selecting DMO Group Call MS to MS (3 1)

To change from gateway or repeater mode to MS - MS mode (DMO terminal to terminal call):

1. Press , scroll to **3 Config** and press .
2. Scroll to **1 MS - MS** and press . The following message to be displayed for a few seconds: **MS - MS Will Be Used**.

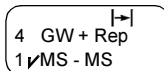

Selecting DMO Group Call via Gateway (☎ 3 2)

While in DMO, proceed as follows to choose a gateway to set up a call via Gateway for the selected talkgroup:

1. Press ☎, scroll to **3 Config**, and press ✓.
2. Scroll to **2 Gateway** and press ✓.

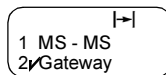

3. The display shows the last gateway selection method. Use the navigation key to scroll to your selection and press ✓:

Automatic — the MTM800 will use the first available gateway for that talkgroup. The Gateway icon will flash upon selecting that option.

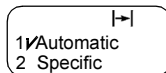

Specific — the MTM800 will use only the gateway with the specified Gateway address for that talkgroup.

Upon selecting “Specific”, you will see one of the following displays:

- The selected gateway address (e.g.: 1022), pre-programmed by your Service Provider or previously entered by yourself via the keypad. Press ✓ to use the current address, or enter a new address via the keypad, and press ✓. The Gateway icon will flash upon selecting the gateway.
- “None”, indicating that no gateway was selected for that talkgroup. Enter an address via the keypad, and press ✓. The Gateway icon will flash upon selecting the gateway.

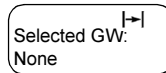
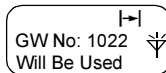

When the MTM800 detects the suitable gateway, the Gateway icon will turn solid.

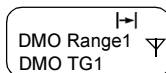

Selecting DMO Group Call via Repeater (📡 3 3)

While in DMO, proceed as follows to choose the Repeater option to set up a call via Repeater for the selected talkgroup:

1. Press 📡, use the navigation keys to scroll to **3 Config** and press ✓.
2. Scroll to **3 Repeater** and press ✓.
3. The MTM800 will use the first available repeater for that talkgroup. The repeater icon will flash upon selecting that option.

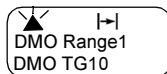

When the MTM800 detects the proper repeater presence signal, the Repeater icon will turn solid.

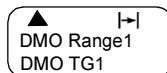

Selecting DMO Group Call via Gateway and Repeater (📡 3 4)

While in DMO, proceed as follows to choose the Gateway and Repeater option to set up a call via Gateway or Repeater (Gateway preferred) for the selected talkgroup.



1. Press 📡, scroll to **3 Config.** and press ✓.
2. Scroll to **4 GW + Rep** and press ✓.
3. The display shows the last "GW + Rep." type selection. Use the navigation key to scroll to your selection and press ✓:



Automatic — the MTM800 will use the first available gateway for that talkgroup. The Gateway icon and the repeater icon will flash upon selecting that option.

Specific — the MTM800 will use only the gateway with the specified Gateway address for that talkgroup.

Upon selecting “Specific”, you will see one of the following displays:

- The selected gateway address (e.g.: 1022), pre-programmed by your Service Provider or previously entered by yourself via the keypad. Press  to use the current address, or enter a new address via the keypad, and press . The gateway and repeater icons will flash upon selecting the gateway.
- “None”, indicating that no gateway was selected for that talkgroup. Enter an address via the keypad, and press . The Gateway and Repeater icons will flash upon selecting the gateway.

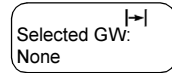
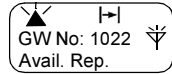

When the MTM800 detects the appropriate gateway and/or the Repeater, the Gateway and/or Repeater icons will turn solid, respectively.

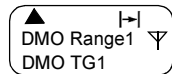

Making a DMO Group Call (MS to MS)

1. Press and hold  for a few seconds.
2. To change range and talkgroup, see steps 3 and 4 of “Making a Group Call” on page 33.
3. If this is the desired talkgroup and range, press the **PTT** button. Wait for the “Talk permit” tone (if configured) and then speak into the microphone. Release the **PTT** button to listen.

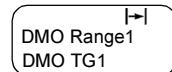
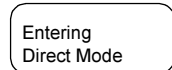
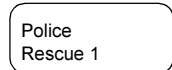

To change talkgroup and range, see the Group Mode section, page 29.

Making a DMO Group Call via Gateway

1. While in DMO, choose a gateway as described in “Selecting DMO Group Call via Gateway” on page 42.
2. Place the call for the selected talkgroup:
 - If you press **PTT** while the gateway is not available, you will start a DMO call without gateway. The Gateway icon will extinguish.
 - If you press **PTT** while the selected gateway is available, but the call is rejected by the gateway, your MTM800 will sound a tone and display the following screen, informing you that the call via Gateway was aborted and that the terminal will automatically proceed to initiate a DMO call without gateway. The Gateway icon will disappear.
 - If you press **PTT** while the gateway is available, you will start a DMO call with gateway. The Gateway icon will turn solid.

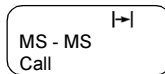

Making a DMO Group Call via Repeater

1. While in DMO, choose the Repeater option as described in “Selecting DMO Group Call via Repeater” on page 43.
2. Place the call for the selected talkgroup:
 - If you press **PTT** while the repeater is not available, you will start a DMO call without repeater. The Repeater icon will disappear.
 - If you press **PTT** while the selected repeater is available, but the call is rejected by the repeater your MTM800 will sound a tone and display the following screen, informing you that the call will be setup without repeater. The Repeater icon will disappear.
 - If you press **PTT** while the gateway is available, you will start a DMO call with gateway. The Repeater icon will be solid.

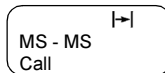

Making a DMO Group Call via Gateway and Repeater

1. While in DMO, choose the Gateway and Repeater option as described in “Selecting DMO Group Call via Gateway and Repeater” on page 43.
2. Place the call for the selected talkgroup:
 - If you press **PTT** while both gateway and repeater are *not available*, you will start a DMO call without gateway and repeater. The Gateway and Repeater icons will disappear.
 - If you press **PTT** while both gateway and repeater are *available*, but the call is rejected by the gateway, a repeater call will be attempted.
 - > If it is *successful* your MTM800 will display the message **Repeater Call** and a call via repeater will proceed. The Gateway icon will disappear.
 - > If it is *not successful* your MTM800 will display the message **MS-MS Call** and a terminal to terminal call will proceed. The Gateway and Repeater icons will disappear.
 - If you press **PTT** while both gateway and repeater are *available*, a gateway call will be attempted.
 - > If it is *successful* your MTM800 will start a DMO call with gateway. The Gateway icon will be solid. The Repeater icon will disappear.
 - > If synchronising with a gateway is *not successful* a repeater call will be attempted.
 - > If it is *successful* your MTM800 will display the message **Repeater Call** and a repeater call will proceed. The Gateway icon will disappear and the Repeater icons will be solid.
 - > If it is *not successful* your MTM800 will display the message **MS-MS Call** and a terminal to terminal call will proceed. The Gateway and Repeater icons will disappear.

NOTE

If Gateway and Repeater mode is selected, and if one of the devices is not available, the call setup is proceeding as if this device was not selected.

Example: In case of the Gateway is available and the Repeater is not available, after an unsuccessful Gateway call attempt the call falls back to MS - MS mode immediately with the **MS-MS call** message.

Receiving a DMO Group Call

You can receive a DMO Group Call only when your MTM800 is in DMO.

Your MTM800 will display the caller's private number or alias and the talkgroup name.

The following screens show examples of how the caller's identity can be displayed.

NOTE

For call alert, see settings in the Tones menu option (page 85).

Receiving a DMO Group Call (MS - MS)

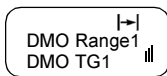

Without alias
and private ID

or

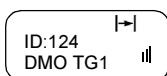

Private ID without alias

or

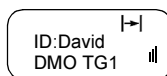

Private ID with alias

Receiving a DMO Group Call (via Gateway / Repeater)

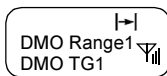

Without alias
and private ID
(e.g. via gateway)

or

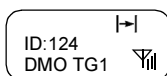

Private ID without alias
(e.g. via gateway)

or

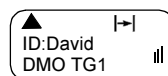

Private ID with alias
(e.g. via repeater)

The Gateway or the Repeater icons are displayed accordingly to the ongoing call type (Gateway or Repeater).

NOTE

- *If MS to MS mode is selected, and the terminal receives a call via repeater, the Repeater icon will be shown (if the repeater mode is enabled by the Service Provider, otherwise the call will not be accepted).*
- *If Gateway mode is selected but a gateway is not available, The Gateway icon will be solid in case of an incoming gateway call.*

DMO Private Call

If configured by your Service Provider it is possible to make and receive a Private Call in DMO.

However the Gateway and/or Repeater options are activated they are not used for a DMO Private Call. The DMO Private Call will be a direct communication between two TETRA terminals (MS - MS).

For detailed information, see “Private Call in DMO” on page 52.

Receiving an Emergency Group Call

For detailed information, see “Emergency in DMO” on page 63.

Private Call

General

A Private Call, also called Point to Point or individual call, is a call between two individuals. No other terminal can hear the conversation.

This call can be a

- *full-duplex* call (if the system allows) in **TMO**, or
- a *half-duplex* call in **TMO** or **DMO**.

In a full-duplex call, both participants can speak at the same time, while only one person can speak at a time during a half-duplex call.

NOTE

If your Service Provider has restricted access to the Address Book, it might not be possible to create a new contact, edit existing contacts or dial up a number which is not in the Address Book.

Entering Private Mode

To enter the Private Mode press .

In this example, 8008801 is the private number of the last calling or called terminal.

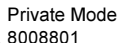

Private Mode
8008801

No alias is displayed since it is not pre-programmed in the private number list. If this is the person you wish to call, press the **PTT**.

If you wish to talk to a person other than the one shown, you can enter another private number in one of the following ways:

- last number called,
- direct entry,
- short number dial or
- list scroll.

Press  to return to the Private Mode display.

Operating with MTM800 in RF sensitive areas, see “Transmit Inhibit” on page 36.

NOTE

While Transmit Inhibit is activated, an incoming Private Call is indicated, but it is not possible to answer the call.

Entering the Private Number

Last Number Called

Press **PTT** to recall the last called number.

Direct Entry

Enter the private number. If the number entered is in the pre-stored private address book, the MTM800 will find it for you.

Short Number Dial

If set up by your Service Provider, Short Dial allows you to dial part of the full number of the person you wish to call. Your MTM800 will automatically complete the number and send it over the air based on your own terminal’s identity.

For example:

1. Dial 456 (instead of 4282456, the full number).
2. To place the call, press the **PTT**.
3. To hang up, press .



List Scroll



To scroll back or forward through the stored list of numbers and names, press  or .

Making a Private Call in TMO

1. Enter the number of the person you wish to call.
2. Press and release the **PTT** button. You will hear a ringing tone. Wait for the called person to answer your call.
3. Press and hold **PTT** when talking, and release the **PTT** when listening.
4. To end the call, press . If the called person ends the call, the **Call Ended** message is displayed.

Making a Private Full-Duplex Call in TMO

1. Enter the number of the person you wish to call.
2. Press .
Select **Send** and press  again.

1 More
2  Send
3. Once the call is successfully initiated, you will hear a ringing tone. Wait for the called person to answer your call.
4. To end the call, press . If the called person ends the call, the **Call Ended** message is displayed.

Receiving a Private Call in TMO

1. The MTM800 automatically switches to Private mode and starts ringing. The Private Call icon starts blinking, and the display shows the caller's identity.
2. To answer the incoming call, press **PTT**.
3. To end or cancel the call, press . The display returns automatically to the mode it was before the incoming call arrived.

If the called person ends the call, the **Call Ended** message is displayed.

NOTE For call alert, see settings in the *Tones menu option (page 85)*

Receiving a Private Full-Duplex Call in TMO

1. The MTM800 automatically switches to Private Mode and starts ringing. The display shows the caller's identity.

Prvt Call
ID: 82114
2. To answer the incoming call, press **PTT**
3. To end or cancel the call, press . The display returns automatically to the mode it was in before the incoming call arrived.

If the called person ends the call, the **Call Ended** message is displayed.

NOTE For call alert, see settings in the Tones menu option (page 85).



Private Call in DMO

If configured by your Service Provider it is possible to make and receive a Private Call in DMO. You can make or receive a DMO Private Call only when your MTM800 is in DMO.

NOTE Private Calls via DMO Repeater and/or DMO Gateway are not supported.

The calling and called party shall be on the same talkgroup.

Making a DMO Private Call

1. To enter the Private Mode press 
2. Enter a number like described in “Entering the Private Number” on page 50.
3. Press and hold **PTT**. Wait for the talk permit tone (if configured) before talking, and release the **PTT** when listening.
4. The call ends after a pre-programmed time, or if you press .

Private Mode
2234

NOTE There is no presence check for Private Calls in DMO. This means you don't know whether the called party is available when you starts the call.

Receiving a DMO Private Call

When a DMO Private Call is received, the call is started immediately without need to accept it by the called party.

Prvt in Use
David

1. Press **PTT** to talk back and start talking.
2. The call ends after a pre-programmed time, or if you press .

NOTE If the called party presses  the DMO private call is suspended for a specified time and in case the calling party is still transmitting the call is joined again.





Dialing on receiving a call

If you dial and a call is incoming, the MTM800 stays in current mode and the display remains unchanged while you hear the call. Dialing continues on current display.

NOTE When an Emergency Call is received, then dialing is aborted, the MTM800 switches to the group mode and Emgcy In Use display appears.

Making a Private PPC (Pre-emptive Priority Call)

NOTE This feature is only available if set up by your Service Provider.

1. Enter the private number and press **PTT**, or for a full-duplex call press , select **Send** and press  again.
2. If the display shows the called user is busy, press  to interrupt the on-going call, or if not press  to end.
3. You will hear a ringing tone. Wait for the called person to answer your call.
4. Continue the call as in a regular half-duplex or full-duplex Private Call.

Party busy
Interrupt?

Call Queuing

When there are no available infrastructure resources for a call while in a setup phase, or while in an active call during cell re-selection, the call will be queued. The MTM800 will remain in queue for a pre-programmed period of time. If the resources become available, the call will proceed. If there are no resources after a certain period of time, the MTM800 will end the call.

Phone and PABX Calls

General

The **Phone Mode** allows you to call a landline telephone number or a cellular mobile phone number. In this publication we use “phone number” when referring to these numbers.

The **Private Automatic Branch Exchange (PABX) mode** allows you to call local (office) extension numbers, if this mode has been activated by your Service Provider.

Both modes have the same dialling features.

Operating with MTM800 in RF sensitive areas, see “Transmit Inhibit” on page 36.

NOTE *While Transmit Inhibit is activated, an incoming Phone or PABX Call is indicated, but it is not possible to answer the call.*

NOTE *If your Service Provider has restricted access to the Address Book, it might not be possible to create a new contact, edit existing contacts or dial up a number which is not in the Address Book.*

Making a Phone or PABX Call

1. Press .

Scroll to your selection using the navigation keys and press .

1 ✓ Phone
2 PABX

2. Last dialled number is presented on your display just after changing to Phone/PABX Mode.

Phone Mode
039694040

In this example, 039694040 is the last dialled phone number.

3. If this is the person you wish to call, press **PTT**.
4. To hang up, press .

If you wish to talk to a person other than the one shown, you can enter another number in one of the following ways:

- last number redial,
- direct dial,

- speed dial,
- one-touch dial, or
- list scroll.

Press  to return to the mode display.

Last Number Redial



When no number is displayed, pressing **PTT** will redial the last dialled number.

Direct Dial

1. Dial the full phone number using the keypad.
2. To place the call, press **PTT**.
3. To hang up, press .

Speed Dial

Speed dial allows you to dial a shortened number of up to two digits instead of the full number. The speed dial number is the location of an entry in the address book.

1. Enter the pre-programmed speed dial number (for example: 5) and press .
2. To place the call, press **PTT**.
3. To hang up, press .

One-touch Dial



One-touch dialling allows you to place a call by pressing and holding one of the numeric keys (2 to 9). The number is the location of an entry (2 to 9) in the address book.

1. Press and hold the required numeric key for a few seconds. Your MTM800 will display the number and dial it.
2. To hang up, press .

NOTE

If the one-touch feature is enabled, one-touch dial is disabled (see page 18).

List Scroll

1. To scroll backwards or forwards through the stored list of numbers and names, press  or . The display will show aliases (names) whenever these have been entered. Where there are no aliases, the numbers will be displayed.
2. To place the call, press **PTT**.
3. To hang up, press .

NOTE

When an alias is displayed, you can see the number by pressing .

DTMF Overdial

If set up by your Service Provider, DTMF allows you to communicate with an automated answering device (for example, the voice mail or answering machine) during an ongoing call.

While in an ongoing call, press the keys 0 to 9, *, #. When pressed, the key will sound a tone and the entered digit will be displayed on the screen.

Phone In Use
12345*#67890

Dialing on receiving a call

See “Dialing on receiving a call” on page 53.

Answering a Phone or PABX Call

1. The MTM800 automatically switches to Phone mode and starts ringing. The Phone icon starts blinking.
2. To answer the incoming call, press **PTT** or any key (except Power On/Off).
3. To end or cancel the call, press . The display returns automatically to the mode it was before the incoming call arrived.

If the called person ends the call, the **Call Ended** message is displayed.

NOTE *For call alert, see settings in the Tones menu option (page 85).*

Emergency Mode

General

In **Trunked Mode** (TMO) you can send an **Emergency Alarm** to the dispatcher and you can initiate and receive an **Emergency Group Call**. A terminal in TMO receives an Emergency Group Call to the selected group associated ATG (Announcement Talkgroup), or scanned group. If the ATG is the currently selected group, the terminal will receive the Emergency Group Call to the group associated with this ATG. (For information on the ATG, see page page 29.) Your MTM800 may also enables you to make an Emergency Group Call without the need to press and hold the PTT (Hot Microphone feature).

In **Direct Mode** (DMO) you can initiate and receive an **Emergency Group Call**.

Your Service Provider may configure

- the Emergency Group Call,
- the Emergency Private Call (if supported by the infrastructure),
- the Emergency Alarm,
- the Hot Microphone feature, and
- the Emergency Mode indication.

The terminal stays in Emergency mode when switching from TMO to DMO. The Emergency mode is also kept while switching from DMO to TMO if Emergency mode is available in TMO.

The calls will get emergency priority in the system.

These feature are active if the MTM800 is in service and attached to any talkgroup.

An Emergency Group Call is configured as non-tactical or tactical:

- A **non-tactical** call initiates on a talkgroup designated by your Service Provider. The group might be different than the one displayed on the terminal screen when starting the call. After exiting from non-tactical emergency mode the terminal will be attached to the group that was selected before initiating the non-tactical call. When in non-tactical emergency mode, you will not be able to switch talkgroups.

DGNA messages have no impact during non-tactical emergency mode but only after exiting the non-tactical emergency mode.

- A **tactical** call initiates on the currently selected talkgroup.

NOTE For call alerts, see settings in the Tones menu option (page 85).

Entering TMO or DMO

Enter TMO or DMO in one of the following ways:

- Press and hold  for a few seconds (TMO/DMO)

Entering or Exiting Emergency Mode

To enter Emergency mode from any mode, press .

NOTE Upon entering Emergency Mode in TMO, the MTM800 will automatically send an Emergency Alarm to the dispatcher (if configured by your Service Provider).

The terminal exits Emergency mode and switches to Group mode in one of the following cases:

- You press and hold .
- The terminal fails to attach to a non-tactical group.
- The system infrastructure detaches the selected non-tactical group.

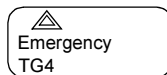

NOTE

The required time you need to press the Emergency key is by default set to 0.5 seconds. The time can be configured by your Service Provider.

NOTE

Pressing the Emergency Key even if Transmit Inhibit is activated causes immediately the terminal to radiate. When entering the Emergency Mode the terminal should not be within the RF sensitive area any longer!

NOTE

The MTM800 interrupts the Ambience Listening call when you press the Emergency key .

Invisible Emergency

NOTE



This feature can be enabled/disabled by your Service Provider.

Invisible Emergency mode is a type of emergency services that provides no audible indications and the display corresponds to the idle state for any Emergency operations. In this mode, only the user knows that the radio is in the Emergency mode and sends out Emergency alarm.

All the settings are restored when the user exits the Emergency mode.

To exit Invisible Emergency mode, the user needs to press the softkey labelled **Exit**.

Changing Range or Talkgroup

If the Emergency Group Call is configured to “tactical”, you can select a talkgroup other than the one displayed, press  and then .

To change the range press , and proceed as explained in “Making a Group Call” on page 33.

Emergency in TMO

Sending an Emergency Alarm

Your MTM800 will send an Emergency Alarm (if configured by your Service Provider):

- automatically, upon entering Emergency Mode
- if you press  while the MTM800 is in Emergency Mode.
- If you change group while in Emergency Mode.

The screen will show one of the following delivery reports:

- **Alarm Sent**
- **Alarm Failed**

In both cases, the screen returns within a few seconds to the main screen of the Emergency mode.

Due to no delivery confirmation in DMO, **Alarm Sent** information confirms only sending the alarm.

Or - if configured by your Service Provider - your MTM800 will send an Emergency Alarm:

- If you press the Emergency button/foot switch without entering Emergency Mode before.
 - Other Emergency services such as starting TMO Emergency Mode or initiating Emergency Private Call (if supported by the infrastructure) will be unavailable.
 - No visible and audio indication on sending Emergency Alarm will be done.

NOTE

Some systems do not support the Emergency Alarm feature when the user is in a "Local Area Service" area. (See page 24.)

Making an Emergency Group Call

To initiate or answer a call while in Emergency mode:

1. Press and hold **PTT**
2. Wait for the talk permit tone (if configured) and talk.

3. Release PTT to listen.

NOTE

*Your MTM800 enters TMO by pressing the **Emergency** button (if configured by your Service Provider). The terminal attaches to the predefined talkgroup and starts the Emergency Group Call. If the predefined talkgroup is invalid the terminal attaches to the last selected talkgroup.*

Hot Microphone Feature

If the Hot Microphone feature was programmed into your MTM800 by your Service Provider, you can make an Emergency Group Call without the need to press and hold the PTT.

The following will happen upon entering Emergency mode:

1. The MTM800 will automatically send an Emergency Alarm to the dispatcher (if configured by your Service Provider).
2. A talk permit tone will be heard.
3. The following typical display will appear:

The microphone will stay open for a time period determined and programmed by your Service Provider.

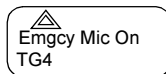

After the Hot Microphone time period expires, or if you press PTT during the Hot Microphone period, the **Emgcy Mic Ended** message will be displayed, and the terminal reverts back to Emergency Mode. The Hot Microphone feature is now disabled and PTT operation reverts back to normal.



To resume, press  again.

If talk permit is granted to another member of the group, an "Emergency call received" tone will be heard.



If configured by your service provider, your MTM800 will automatically attempt to get talk permit again and the **Wait For Mic** message will be displayed.

NOTE *During this pending time the MTM800 microphone is not active until the **Emgcy Mic On** message is displayed again.*

Receiving an Emergency Group Call

A terminal in TMO receives an Emergency Group Call to the selected group or associated ATG (Announcement Talkgroup), or scanned group. If the ATG is the currently selected group, the terminal will receive the Emergency Group Call to the group associated with this ATG. (For information on the ATG, see page 29.)

When the MTM800 receives the call, the display will show the caller's identity. If the display is idle, it will show **Emrgncy-In Use**.

If upon entering Emergency mode your MTM800 receives an emergency call, and Hot Microphone was enabled by your Service Provider, the **Wait For Mic** message will be displayed. Your MTM800 will attempt to get a talk permit.

Emergency in DMO

You can initiate an Emergency Group Call to a group.

You can receive a call from the selected talkgroup, and (if configured by your Service Provider) from other users within talkback range or from an open group. (An open group is a super-group to which all DMO groups belong.)

Emergency calls can be placed via gateway and repeater. For gateway and repeater settings, see "Gateway/Repeater Selection" on page 41.

Making an Emergency Group Call

To initiate or answer a call:

1. Enter emergency mode by pressing and holding the  key.

2. Press and hold **PTT**.
3. Wait for the talk permit tone (if configured) and talk.
4. Release **PTT** to listen.

Receiving an Emergency Group Call

The display shows the caller's identity as a private number or an alias. If the display is idle, it will show **Emergency-In Use**.

GPS Location Service

General

Your terminal's GPS Location feature uses information from Global Positioning System (GPS) satellites orbiting the earth to determine the approximate geographical location of your terminal. The availability and accuracy of this location information (and the amount of time that it takes to calculate it) will vary depending on the environment in which you are using the terminal.

For example, GPS location fixes are often difficult to obtain indoors, in covered locations, between high buildings, or in other situations where you have not established a clear broad view of the sky.

See **“IMPORTANT - Things to Keep in Mind”**.

The GPS location Service can assist your Dispatcher or Colleagues in many ways such as more efficient deployment of resources or locating your terminal if you trigger your emergency service.

The terminal can be configured to display location information on the terminal's display or to send it over the air to your dispatcher where it can be displayed in control center (Please check with your Service Provider on the configuration of your terminal).

IMPORTANT - Things to Keep in Mind

Where adequate signals from multiple satellites are not available (usually because your GPS antenna cannot establish a view of a wide area of open sky), the GPS feature of your terminal **WILL NOT WORK**. Such situations include but are not limited to:

- In underground locations
- Inside of tunnels or parking garages
- Under any other metal or concrete roof or structure
- Near a powerful radio or television tower

- When your GPS antenna is covered (for example, by your hand or other object) or facing the ground
- In temperature extremes outside the operating limits of your terminal

Even where location information can be calculated in such situations, it may take much longer to do so. Therefore, in any emergency call, always report the location to your dispatcher.

Furthermore, please note that even where adequate signals from multiple satellites are available, your GPS feature will only provide an approximate location, often within 20 - 100 meters from your actual location.

Enhancing GPS Performance

Sometimes the GPS feature of your terminal may be unable to complete a location calculation successfully. You will see a message indicating that your terminal cannot see enough visible satellites.

To maximize the ability of your terminal to determine a location fix please note the following guidelines:

- The GPS feature works best where there is nothing between your terminal and a large amount of open sky. If possible, go outside, away from tall buildings and foliage.
- Position your motorcycle to enhance reception, giving the antenna clear access to satellite signals. Signals from GPS satellites are transmitted to your GPS antenna, which is in your terminal antenna. Do not cover the antenna area with your fingers or anything else.
- Stay in network coverage. Depending on who your service provider is, the network will provide your terminal with information that helps determine your location more quickly and accurately.

GPS Enable/Disable

( 9 2)

1. From the main menu, press  **9 Location - 2 Interface.**

The current selection (On/Off) is highlighted. The display shows:

On — Location Service On

Off — Location Service Off

2. Scroll to your selection and press .

If GPS is enabled but the radio is not synchronized to the GPS satellites the following idle screen is displayed:

Range 1
No GPS signal

Entering GPS Location Service

( 9)

To enter the GPS sub-menu, press

 - **9 Location.**

Position — provides the actual position information.

Interface — allows you to enable/disable the GPS location service.

This estimate of accuracy of the calculated location is only a very rough estimate and may vary substantially from the actual accuracy of the approximate location information reported.

1 Position
2 Interface

NOTE

- *The variation will vary in accordance to the GPS Configuration set by your Service Provider.*
- *The availability of the GPS Location menus is dependent on your terminal configuration, please contact your Service Provider for further details.*

Viewing Your Position (9 1)

1. From the main menu, press  - **9 Location - 1 Position**.
2. This displays the following information about the last time your location was calculated (if available):

UTC — The **time** the location was last calculated.

LAT — The **latitude** expressed in degrees, minutes, and seconds.

LNG — The **longitude** expressed in degrees, minutes, and seconds.

SAT — The **number of satellites** used to calculate the location. In general, more satellites make for better accuracy.

3. Scroll to view the entire screen.

For tips on getting the best location calculation, see “Enhancing GPS Performance” on page 66.

4. Press  to return to the previous screen.

Each time approximate location of your terminal is calculated, the latest location information is stored in your terminal and remains there even when your terminal is powered off. You will see this information the next time you view the **Position** screen.



If you received a terminal call or alert while attempting to determine your location, the **Position** screen will disappear, but your terminal will continue attempting to determine its location. If it is successful, the new location information will be displayed the next time you view the **Position** screen.

The Menu

Entering the Menu Options

You can enter the menu options during a call. If you are viewing a menu when a new call starts, the terminal will exit the menu.

By Scrolling

1. From any mode, press  to enter the Menu.
2. To scroll to the required option (such as **2 Addr. Book**), press the navigation keys.
3. To enter the option, press .

If the sub-menu contains a further set of sub-menus as in the example below, repeat steps 2 and 3.

By Shortcut

You can use the number next to the option as a shortcut to access the required sub-menu.

1. From any mode, press .
2. Key the number of the required option.

For example, to reach **4 Mem Usage** of the example below, press  and key the option numbers **2 1 4**.

Exiting the Menu Options

To exit the menu or sub-menu, press  or .

Exiting the Menu

Press and hold  from any menu option. The display returns to the mode previous to entering the Menu.

NOTE *If enabled by your Service Provider, the menu could time out if no keypresses are detected for a preset period of time.*

List of Menu Options

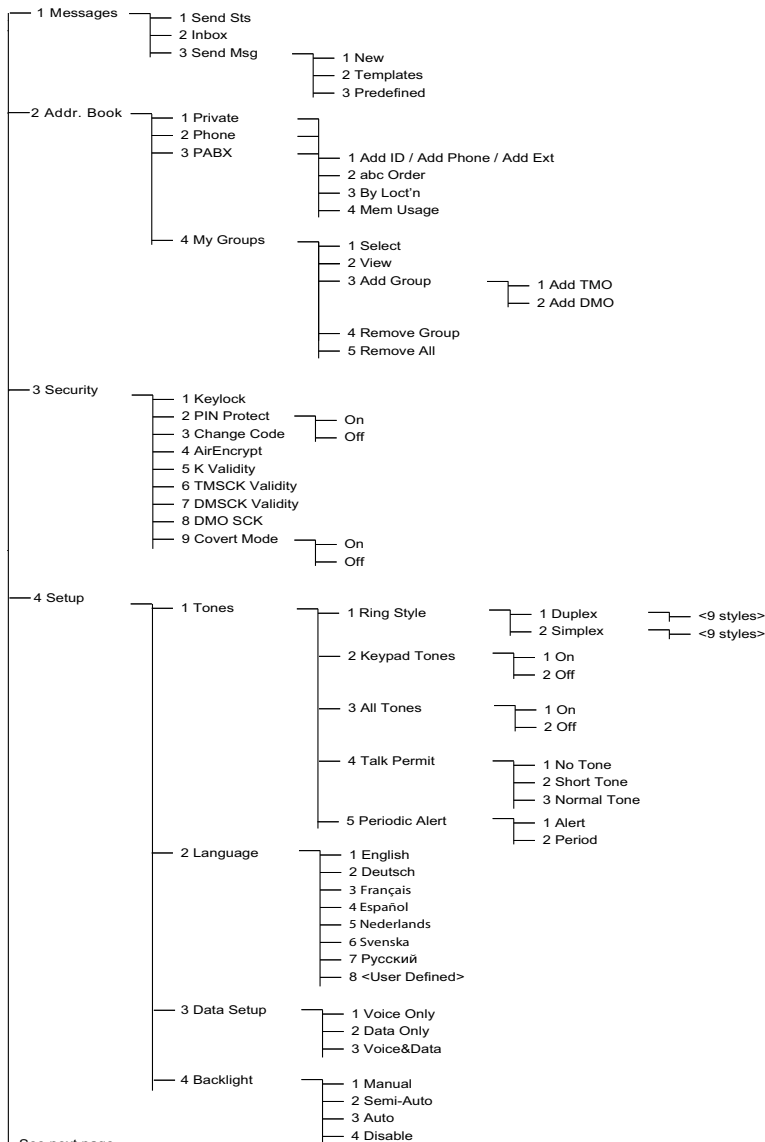

See next page

List of Menu Options (Cont'd)

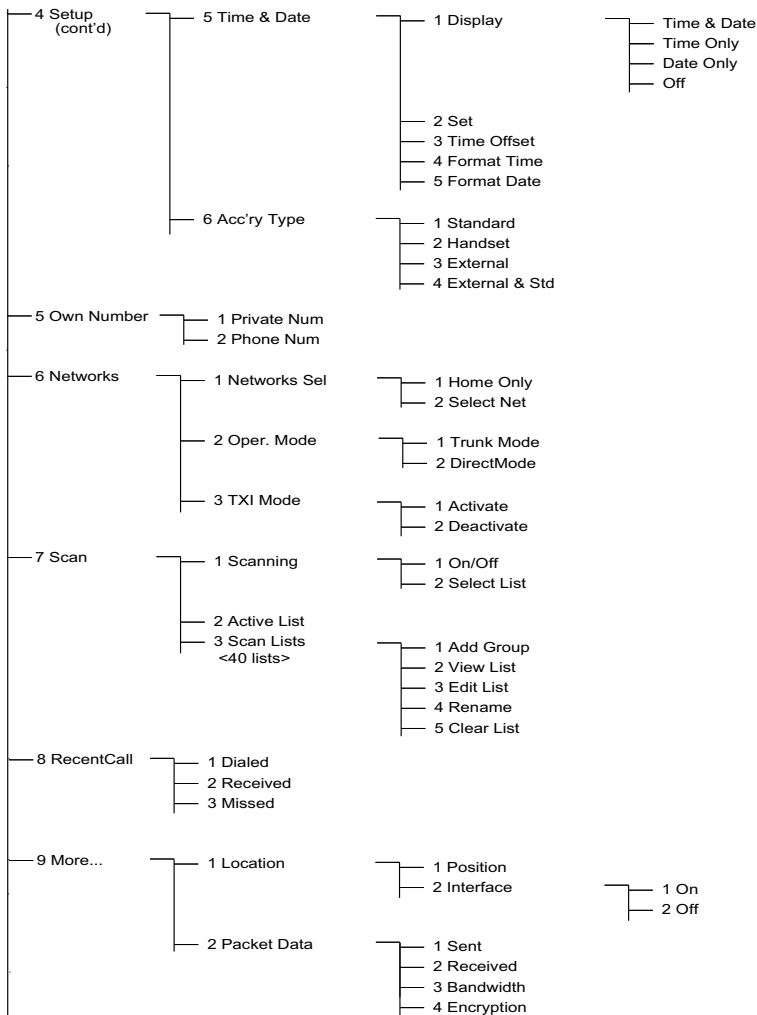

NOTE

It is possible that some menu numbers are different to that listed. Some options can be enabled/disabled by your Service Provider which can cause the exact menu index numbers to vary.

Messages (☎ 1)

Refer to “Messages” on page 96 for details.

Address Book (☎ 2)

To enter the Address Book sub-menu, press ☎ 2 **Addr. Book**.

3 PABX
1✓Private

- This sub-menu allows you to add, search, edit, or erase entries in the private, phone and PABX address books.

NOTE

If set up by your Service Provider, it is not possible to create or edit an Address Book entry or to dial a number which is not in the Address Book. The menu items for creating, editing, and deleting contacts in the Address Books are not available.

NOTE

Updating your private call address book is done in the same way as updating the phone address book and the PABX address book. When using shortcuts to reach the relevant sub-menus, be sure to use the correct digit sequences referenced in the list of menu options on page 70.

- Select, view, add, or remove favourite groups.

3 PABX
4✓My Groups

Updating the Private Call Address Book (☎ 2 1)

To enter the sub-menu, press ☎ - 2 **Addr. Book** - 1 **Private**.

4 Mem Usage
1✓Add ID

This sub-menu allows you to edit your private call address book.

Adding a Number (☎ 2 1 1)

To enter the sub-menu, press ☎ - 2 **Addr. Book** - 1 **Private** - 1 **Add ID**.

NOTE

1 Add ID changes to 1 Add Phone or to 1 Add Ext. depending on the address book edited.

1. Press . The MTM800 will prompt you to add an entry to the existing list. The entry is composed of a number, name, and location. First enter the number and name.
2. Press to confirm. Then select the location of the entry in the list.
3. The first empty location (if any) is suggested as the default location for storing the entry. You can select another location either by scrolling through the list of locations or by typing the location number. If a location is already used, you will be prompted to overwrite the existing entry started in that location.
4. When the entry is successfully stored, the display returns to the entry adding screen within a few seconds.

Searching the Address Book Alphabetically (2 1 2) or by Location (2 1 3)

1. To enter the sub-menu, press - 2 **Addr. Book** - 1 **Private** and 2 **abc Order** or 3 **By Locat'n**.

1 Add ID
 2 abc Order
2. Scroll through the list alphabetically (or type the first letter of the name you are searching in the pre-stored list). Alternatively, scroll through the list by location (or type the location number).
 After finding a number, press **PTT** to start a call.
3. Scroll to your selection:
 - **Edit** the entry (see “Editing the Text” on page 16). The original location is suggested as the default location for storing the edited entry.
 To select another location, scroll through the list of locations or type the location number. If a location is already used, you will be prompted to overwrite the existing location.
 When the location is successfully stored, the screen returns to the list display.

- **Erase** the entry. The screen returns to the list display.

Memory Usage (2 1 4)

To enter the sub-menu,
press  - 2 **Addr. Book** - 1 **Private** - 4 **Mem Usage**.

This screen shows how much memory is left to add new entries to the address book.

My Groups (2 4)

Once in the menu, select **2 Addr. Book** - **4 My Groups**.

5 Remove All
1 ✓ Select

This sub-menu allows you to edit your favourite group list.

Entering My Group (2 4 1)

1. Once in the menu, select **2 Addr. Book** - **4 My Groups** - **1 Select**.

My Groups is displayed as the selected range alias. You can now scroll through the favourite group list. Press  to select.

NOTE

My Groups range is situated after the last range. Scrolling past the last group in the My Groups range will therefore bring you back to the first valid range.

When selecting “My Groups” and no groups exist from the current DMO/TMO mode, you may be forced to switch to DMO from TMO or TMO from DMO. In this case you will be prompted to accept the mode change.

Viewing My Group (2 4 2)

1. Once in the menu, select **2 Addr. Book** - **4 My Groups** - **2 View**.
2. Scroll through the favourite group list.

Adding a Group to My Groups (2 4 3)

1. Once in the menu, select **2 Addr. Book** - **4 My Groups** - **3 Add Group**.

2. Select one of the following:

Add TMO — You may choose any TMO Range/Group.

1 ✓ Add TMO
2 Add DMO

Add DMO — You may choose any DMO Range/Group.

Removing a Group from My Groups (2 4 4)

1. Once in the menu, select **2 Addr. Book - 4 My Groups - 4 Remove Grp.**

2. Select the group you wish to remove. In the “Remove?” prompt screen, select **Yes** to confirm removal.

Removing All Groups from My Groups (2 4 5)

1. Once in the menu, select **2 Addr. Book - 4 My Groups - 5 Remove All.**

2. In the **Remove?** prompt screen, select **Yes** to confirm removal.

Security (3)

To enter the Security sub-menu, press  - **3 Security.**



7 Covert Mode
1 ✓ Keylock

Locking/Unlocking the Keypad (3 1)

To prevent accidental key presses:

1. From the sub-menu, select **1 Key Lock.** All keys are locked except the **On/Off** key.

NOTE

When there is an incoming call and the keypad is locked, you can still use PTT, , and .

2. To unlock the keypad, press  **3 1.**

NOTE

The Emergency Key is not locked. Entering Emergency Mode, unlocks all keys.

PIN protect (3 2)

Network access protection is configured by your Service Provider:

No access to network operation — you can only send or receive Emergency Calls. Unit lock takes effect at the next power on.

To protect access to network operation:

1. From the sub-menu, select **2 PIN Protect**.
2. Select **1 On** to set the protection (or **2 Off** to cancel it).
3. At the **Code?** prompt enter the 4-digit code (factory setting is “0000”). To avoid disclosure of the PIN, asterisks are displayed instead of the code digits. The display will show one of the following messages:

Unit Locked — you entered the correct code. The display returns to the Security sub-menu and shows the active setting: **1 On**.

Unit Unlocked — you entered the correct code. The display returns to the Security sub-menu and shows the active setting: **2 Off**.

To unblock the MTM800 after powering on, enter the code at the prompt. The MTM800 enters the default home mode.

If you fail to enter the correct code, the following message will be displayed:

Incorrect Code Entered — You are prompted to try again. After failing three times, your MTM800 will be blocked.

How to unblock the MTM800

The display shows **Unit Blocked**. When your MTM800 is blocked, you cannot send or receive calls. You can only enter a code or power off the MTM800.

To unblock the MTM800, enter the PUK (Personal Unblocking Key). The PUK is an eight-digit master code to be obtained from your Service Provider.

After entering the PUK successfully, you will be prompted to replace the forgotten PIN code.

At the **New Code?** prompt, enter the new 4-digit code, and repeat the code to confirm. If the code does not match, you will be prompted to enter it again until the new code message is accepted.

Change Code (3 3)

NOTE *The standard factory lock code is "0000".*

To change the PIN code:

1. Select **3 Change Code** and press .
2. At the **Old Code?** prompt, enter the 4-digit code.
 - If the old code does not match at verification, the display shows the **Incorrect Code Entered** message and returns to the Security sub-menu.
 - If the entered code matches the old code, the display prompts you to enter a new 4-digit code and to repeat it for confirmation. If the confirmation code does not match the new code, the display prompts you to re-enter the new code.
3. When the new code is accepted, the display returns to the Security sub-menu.

Air Encryption On/Off (3 4)

To enter the sub-menu, press  - **3 Security - 4 AirEncrypt**.

This sub-menu allows you to view air encryption On/Off state.

Call encryption provides service confidentiality between you and the system.

If encryption is on and you receive a clear call (i.e. un-encrypted), the MTM800 will display a **Call Isn't Encrypt** message.

NOTE *You cannot manually disable Air Encryption (if enabled) from the menu. This menu item only indicates if Air Encryption is enabled at that moment.*

NOTE *The Air Encryption feature is ONLY enabled depending on your Service Provider.*

Air Encryption Key Deletion

Please check with your Service Provider whether the terminal is provided with air interface encryption keys.

You can delete the air interface encryption keys from the terminal by entering the following sequence from the keypad:
****00##**

	CAUTION	<i>Using this feature will disable the terminal, and your Service Provider will need to re-enable the terminal.</i>
---	----------------	---

K Validity (3 5)

Once in the menu, select **3 Security - 5 K Validity**.

K (Key) is a secret key the infrastructure uses to authenticate the MTM800 in the system. It is part of the authentication that provides service confidentiality between your MTM800 and the system.

To verify K validity, press **Ok**. The display will show one of the following messages:

K is Valid — the infrastructure can authenticate your MTM800.

K is Invalid — the infrastructure shall not authenticate your MTM800. Please call your Service Provider to restore K to your MTM800.

TMSCK Validity (3 6)

Once in the menu, select **3 Security - 6 TMSCK Validity**.

SCK (Static Cipher Key) is a secret key the infrastructure uses to encrypt call and data in the system. Air interface encryption provides service confidentiality between your MTM800 and the system. Your MTM800 should be provided with a set of SCKs.

To verify SCK validity for TMO, press **Ok**. The display will show one of the following messages:

TMSCK is Valid — your MTM800 can work encrypted in TMO.

TMSCK is Invalid — your MTM800 cannot work encrypted in TMO. Please call your Service Provider to restore SCKs to your MTM800.

DMSCK Validity (3 7)

Once in the menu, select **3 Security - 7 DMSCK Validity**.

SCK (Static Cipher Key) is a secret key the infrastructure uses to encrypt call and data in the system. Air interface encryption provides service confidentiality between your MTM800 and the system. Your MTM800 should be provided with a set of SCKs.

To verify SCK validity for DMO, press **Ok**. The display will show one of the following messages:

DMSCK is Valid — your MTM800 can work encrypted in DMO.

DMSCK is Invalid — your MTM800 cannot work encrypted in DMO. Please call your Service Provider to restore SCKs to your MTM800.

DMO SCK Validity (3 8)

Once in the menu, select **3 Security - 8 DMSCK Validity**.

Key version is displayed when you select the option.

Air Interface encryption provides service confidentiality between your MTM800 operating in Direct Mode and another terminal or a group of terminals operating in Direct Mode.

You can change the current key, if the key change operation is allowed by your Service Provider.

To change the key, if not in a call, select **Next**. The display will show the following message: **Change to version...**

- Select **Yes** to change the key. **Key version changed** display will appear.
- Select **No** to leave the key. **Key version** display will appear.

Covert Mode (3 9)

From the main menu, select **3 Security - 9 Covert Mode**.

Set Covert Mode to On

Select **1 On**. All tones are set to off, and the backlight and the LED are disabled immediately.

1 On
2 <input checked="" type="checkbox"/> Off

NOTE

The audio is further more routed to the external loudspeaker - if connected - until the loudspeaker is switched off. It is recommended to use e.g. a headset in Covert Mode.

Set Covert Mode to Off

Select **2 Off**. All settings for tones and backlight are restored. The LED is enabled and the message **Covert Mode Off** is shown.

Setup (4)

To enter the sub-menu, press  **4 Setup**.

This sub-menu allows you to change your MTM800 configuration: tones, language, data setup , backlight and time & date.

Setting the Ring Style (📞 4 1)

This option allows you to set the incoming call ring style. Your MTM800 features nine selectable ring styles for **Duplex** and **Simplex** calls:

1 ✓ Ring Style
2 Language

1. Press **📞 - 4 Setup - 1 Ring Style - 1 Duplex** or **2 Simplex**. The display shows the current ring style used (ring style **1 British**, in this example).

1 ✓ British
2 Style 2

2. Scroll to the desired style and press **✓**.

You will hear the new ring style immediately. If necessary, turn the Volume knob to adjust the volume.

Setting the Display's Working Language (📞 4 2)

Once in the Setup sub-menu, select **2 Language**.

6 <User Defined>
1 ✓ English

The display shows the current language used. You can customize your MTM800 to operate in English, German, French, Spanish, Dutch, or in a language defined by your Service Provider. The default setting from factory is English. The default setting from factory is English.

Scroll to the desired language and press **✓**. The display shows the selected language for a few seconds.

Setting Up Data Mode (📞 4 3)

You can connect the MTM800 to an external device (such as a laptop or desktop PC). The MTM800 will then be capable of transmitting and receiving data from the external device. The external device must run an application complying with the TETRA standards.

Once in the Setup sub-menu, select **3 Data Setup**.

The display shows the current setting:

Voice Only — the MTM800 will receive and transmit voice calls only.

1 ✓ Voice Only
2 Data Only

Data Only — the MTM800 acts as a modem. The MTM800 will reject incoming and outgoing voice calls, except for emergency calls, status and text messages.

Voice&Data — the MTM800 acts as a modem but voice calls will have priority over data calls and will interrupt them.

Scroll to the desired setting and press .

In **Data Only** and in **Voice&Data** modes, the “Data Connected” icon is displayed after you have connected the MTM800 to the external device and the MTM800 is ready for data transfer.

The MTM800 ends the Ambience Listening (AL) call and the microphone is closed when the MTM800 is in one of the following states:

- Entering the out-of-service area
- Outgoing packet data call setup

To exit data mode, return to **3 Data Setup** and select **Voice Only**. The MTM800 returns automatically to Voice communication, except when in Data Only Mode.

NOTE *Data services are available only in TMO. Data Services are blocked in TXI Mode.*

Setting Backlight (4 4)

Once in the Setup sub-menu, select **4 Backlight**.



This option allows you to configure your MTM800’s backlight setting (see also “Dimming the Display” on page 26).

Your MTM800 has four backlight settings:

Manual (4 4 1)

You press the  to change the backlight intensity in four steps.

Semi-Auto ( 4 4 2)

You press  to turn on or turn off the backlight. Any other key press does not turn the backlight on. The backlight remains on until you press the  to turn it off, or a pre-programmed timer runs out.

Auto ( 4 4 3)

Any key press turns the backlight on. The backlight remains on until you press  to turn it off, or a pre-programmed timer runs out.

Disable ( 4 4 4)

The backlight feature is disabled.

Setting Time & Date Features ( 4 5)

Once in the Setup menu, select **5 Time&Date**.

5 Format Date
1 ✓ Standard



This sub-menu allows you to control the displayed time and date.

Time&Date Display Settings ( 4 5 1)

Once in the Setup menu, select **5 Time&Date**, and then **1 Display**.

The display shows the current setting:

- 1. Time&Date** - The MTM800 displays time and date.
- 2. Time Only** - The MTM800 displays time only. **Format Date** option is disabled.
- 3. Date Only** - The MTM800 displays date only. **Format Time** option is disabled.
- 4. Off** - The MTM800 does not display time nor date. **Format Time** and **Format Date** options are disabled.



Scroll to the desired setting and press . Press  to exit.

NOTE

Time and date are synchronized by the infrastructure. When not within the infrastructure signal range you can set the values manually.

Setting Time and Date (4 5 2)

To set time and/or date:

1. Enter the **Setup** menu.
2. Select **Time&Date**, and press .
3. Select **Set**, and press .



Enter time using **2**(Up), **8**(Down) keys for adjustment and navigation keys or **4**(Left), **6**(Right) keys for navigation.

Press . Press  to exit.

Setting Offset

(4 5 3)

To set local time offset:

1. Enter the **Setup** menu.
2. Select **Time&Date**, and press .
3. Select **Time Offset**, and press .



Enter offset value using **2**(Up), **8**(Down) keys for adjustment and navigation keys or **4**(Left), **6**(Right) keys for navigation.



Press . Press  to exit.

NOTE *You can adjust the offset value, with 15 minute steps, up to 14 hours ahead or behind.*

Setting Time Format (4 5 4)

To change displayed time format between 24-hour scale and 12-hour scale:





1. Enter the **Setup** menu.
2. Select **Time&Date**, and press .
3. Select **Format Time**, and press .

Choose required setting and press . Press  to exit.

Setting Date Format (4 5 5)

To change displayed date format between DD/MM/YY, MM/DD/YY and DD-MON-YY:

1. Enter the **Setup** menu.

2. Select **Time&Date**, and press .
 3. Select **Format Date**, and press .
- Choose required setting and press . Press  to exit.

Setting Tones (4 6)

Once in the Setup sub-menu, select **6 Tones**.

This sub-menu allows you to activate/deactivate the keypad tones and other tones used in the MTM800.

1  Keypad Tone
2 All Tones

Scroll to the desired setting and press .



The display shows the current setting. When set to **On**, the MTM800 will sound a tone at every key press. When set to **Off**, the MTM800 will mute the keypad tone.

1  On
2 Off

For a detailed list of tones, see “Tones” on page 109.



Setting Keypad Tone (4 6 1)

To activate/deactivate keypad tone at every key press:

1. Enter the **Setup** menu.
2. Select **Tones**, followed by **Keypad Tone**, and press .
3. Scroll through the settings by using the navigation keys.
4. Choose required setting, and press  to select, or press  to exit.

Setting All Tones (4 6 2)

To activate/deactivate all tones (keypad tone and other activity tones used in your MTM800):

1. Enter the **Setup** menu.
2. Select **Tones**, followed by **All Tones**, and press .
3. Scroll through the settings by using the navigation keys.
4. Choose required setting, and press  to select, or press  to exit.

Setting Talk Permit Tone (4 1 4)

There are 3 tone settings:

No Tone — no tone heard upon pressing the **PTT**.

- 2 Short Tone
- 3 Normal Tone

Short Tone — a short tone heard upon pressing the **PTT**.

Normal Tone — the factory-default tone heard pressing the **PTT**.

To change your Talk Permit Tone settings:

1. Enter the **Setup** menu.
2. Select **Tones**, followed by **Talk Permit**, and press .
3. Scroll through the settings by using the navigation keys.
4. Choose required setting, and press to select, or press to exit.

Setting Periodic Alert (4 1 5)

Periodic alert indicates the missed calls and the unread messages. For each indication the unread message tone is played with the amber LED color. This feature can be disabled/enabled by the user.

- 1 Alert
- 2 Period

1. Enter the **Setup** menu.
2. Select **Tones**, followed by **Periodic Alert**, and press .
3. Select **Alert** and choose required setting, and press to select, or press to exit.

The user can also set the time between the indications.

1. Enter the **Setup** menu.
2. Select **Tones**, followed by **Periodic Alert**, and press .
3. Select **Period** and choose required setting, and press to select, or press to exit.

Setting Accessory (4 7)

Once in the **Setup** sub-menu, select **7 Acc'ry Type**.

1 Standard
2 Handset

You can select one of the following options:

Standard — Select this if a Fist Microphone and an external speaker are connected.

Handset — Select this if a Telephone Style Handset is connected.

External — Select this if an external microphone and an external speaker are connected.

External & Std — Select this option if the external mic is to be default one unless PTT is pressed.

NOTE

Accessories has to be configured by MS/CPS user in order to use them.

Own Number (5)

Use this feature to view your own private or phone number at any time.

To enter the sub-menu, press  **5 Own Number**.

Viewing Private Number (5 1) or Phone Number (5 2)

To enter the sub-menu, press  **5 Own Number** and **1 PrivateNum** or **2 Phone Num**.

1 PrivateNum
2 Phone Num

The displayed private number cannot be modified.

To modify the displayed phone number, press . The new phone number does not modify the MTM800 number in the system.

Network (6)

To enter the sub-menu, press  **6 Networks**.

This sub-menu allows you to select the network your MTM800 will be registered to, and what mode it operates on.

3 TXI Mode
1✓ Networks Sel

Selecting Your Network (6 1)

This sub-menu allows you to select the network your terminal will be registered to.

Selecting Home Only Network Registration (6 1 1)

To enter the sub-menu, press

 **6 Networks - 1 Networks Sel - 1 HomeOnly**.

2 SelectNet
1✓ Home Only

Selecting this option causes your MTM800 to recognise the first network on the allowed Network List only and to register to it.

Using the Select Net Option Registration (6 1 2)

To enter the sub-menu,

press  - **6 Networks - 1 Networks Sel - 2 SelectNet**.

If configured by your service provider, this option allows you to select manually the network from the allowed Network List you want your MTM800 to be registered to.

The list of the allowed networks is displayed.

Scroll to the desired network and press .

The display shows **XXX Selected**. The XXX stands for the name of the network selected.

After a few seconds the display returns to the Network sub-menu.

NOTE

It is up to your service provider to ensure your own terminal identity is allowed to register on other networks in your list. Some talkgroups may not be available on other networks.

Setting Operating Mode (6 2)

To enter the sub-menu,
press  - **6 Networks** - **2 Oper. Mode**.

2 DirectMode
1 ✓ Trunk Mode

This sub-menu allows you to select the mode your MTM800 will be operating on.

To set up your operating mode:

Select **2 DirectMode**, or **1 Trunk Mode**, and press .

NOTE To change the Operating Mode quickly you can press .

NOTE It is not possible to switch from Direct Mode to Trunk Mode, if the terminal is in Transmit Inhibit Mode.

Setting Transmit Inhibit (TXI) Mode (6 3)

To enter the sub-menu,
press  - **6 Networks** - **3 TXI Mode**.

1 Activate
2 ✓ Deactivate

This mode should always be set before entering areas where transmission is prohibited, e.g. in hospitals or in potentially explosive areas.

To activate the TXI Mode:

- Select **1 Activate**, and press .

The terminal will sound the “Transmit Inhibit” tone. The display flashes between the Talkgroup name and the message “TXI Mode”, and the solid amber LED indicates the TXI Mode.

NOTE All menu options which cause transmitting are blocked in TXI Mode. It is not possible to change the Talkgroup.

To deactivate the TXI Mode, e.g. after you have left the area where transmission is prohibited:

- Select **2 Deactivate**, and press .

The terminal sounds the “Transmit Inhibit” tone and returns back to Group Mode or Direct Mode, if Direct Mode was the last selected mode.

Scan (7)

To enter the sub-menu, press  **7 Scan**.

This sub-menu allows you to activate/deactivate scanning, view the active scan list, and edit the scan lists.

NOTE *It is not possible to enable or disable Talkgroup scanning in TXI Mode.*

Setting Talkgroup Scanning (7 1)

To enter the sub-menu, press

 - **7 Scan - 1 Scanning**.

3 Scan Lists
1✓ Scanning

This sub-menu allows you to activate/deactivate the scanning of a list of predefined talkgroups programmed in the MTM800. The MTM800 will join any talkgroup call as long as this talkgroup is defined in the scan list and scan is turned on.

Scroll to the desired setting and press  . **If it is set to Off, display shows the following state:**

1 On
2 Select List

When set to **On**, the display shows following state:

1 Off
2 Select List

To select a list other than the one shown, scroll through the scan lists and press .

Select List
Scan List 1

After completing the settings, the display returns either to the Scan sub-menu or to Group mode.

Viewing the Active Scan List (7 2)

To enter the sub-menu, press  - **7 Scan - 2 Active List**.

Active List:
Scan List 1

This sub-menu allows you to view the active scan list.

The display will show one of the following statuses:

- There is a selected, inactive scan list. Scanning is off.
- There is no selected scan list. Scanning is off.

- There is a selected, active scan list. Scanning is on. To see the talkgroup status (active or not active) and priority (if pre-programmed), press , and scroll through the talkgroups.

Editing Scan Lists (7 3)

To enter the sub-menu, press  - 7 Scan - 3 Scan Lists.

The display allows you to scroll through the scan lists to see the number of talkgroups used per list.

Scan List 1
Used: 4 Free: 36



To edit/view the contents of a scan list, press  and scroll to your selection.

Press  to select one of the following options:

5 Clear List
1✓ Add Group

1. **Add** a talkgroup to the selected scan list.

Every added talkgroup (including a favourite group) comes with its range, its name or number, and its priority (if pre-programmed).

- To select a range, scroll through the range list. The list does not show ranges whose talkgroups are fully used in the selected scan list. Press  to select a range.
- To select a talkgroup, scroll through the talkgroup list within the selected range. The list shows talkgroups that are not in the selected scan list. Press .
- To set a priority to a talkgroup, scroll through the priority list: high, medium, or low.

A call from a high priority talkgroup and with a higher priority than the on-going call will interrupt it.

A call from a medium/low priority talkgroup will not interrupt the on-going call.

2. **View** the contents of the active scan list (range, talkgroup, and priority if pre-programmed) by scrolling through it.

Range 1
Talkgroup 1

3. **Edit** the scan list talkgroups. Scroll to your selection and press . Scroll to one of the following options:
 - To **Remove** a talkgroup from the selected scan list, select **1 Remove Grp** and press . You will be prompted to remove the selected talkgroup. After a few seconds, the display shows the following talkgroup in the selected scan list.

1 Remove Grp
2 Priority
 - To change the talkgroup **Priority**, select **2 Priority** and press . Scroll to the selected priority and press . After a few seconds, the display shows the new setting of the selected talkgroup.
4. To **Rename** the active scan list, enter a new name (alias) and press . The display shows the new setting.
5. To **Clear all** talkgroups from the selected scan list, press . You will be prompted to remove all talkgroups from the selected scan list. After a few seconds, the display shows the new setting of the selected scan list.

Recent Calls (8)

You can view the history of all calls:

- Dialed Calls
- Received Calls — calls you answered
- Missed Calls — calls received but not answered, or rejected by the MTM800.

1 Received
2 Missed

Each list of calls may contain up to 10 numbers for all modes (Phone, PABX, or Private), the more recent call being at the top of the list. Old calls are deleted to make room for new ones, if necessary. A number dialed more than once, will appear only once in the list.

Upon receiving a missed call notification, the MTM800 will display the Missed Calls list.

When a call is received during an active call, the number is written to the Missed Calls list. This list will be invoked automatically at the end of the call.

1. From the menu, select **8 Recent Calls**.
2. Scroll to the desired history and press .
3. Scroll through the list of calls. Select Erase to remove an entry from the list. If required, enter the context sensitive menu to save numbers without names in the address book. See “Address Book” on page 72.

PABX
David

Private
Anna

Phone
031234567

4. You can make a Phone, PABX, or Private Call from the entry, depending on the entry you are selecting in the list.

NOTE

If your Service Provider has restricted access to the Address Book, it might not be possible to dial up a number which is not in the Address Book.

5. After completing the call, the MTM800 will return to the Received/Missed/Dialled list, displaying the called number and allowing you to delete or save the number in the address book.

Location ( 9 1)

Refer to “GPS Location Service” on page 65 for details.

Packet Data ( 9 2)

This menu item allows to display statistical values related to a packet data connection. If Multi Slot Packet Data Service is enabled by your Service Provider the screens present information about

- Amount of sent data,
- Amount of received data,
- Bandwidth of the data session

1 ✓ Sent
2 Received

3 ✓ Bandwidth
4 Encryption

- Data encryption status.

NOTE

Data services are only available in TMO. The data option must be set to Voice&Data or Data Only. (Refer to “Setting Up Data Mode” on page 81).

Viewing Sent Data Statistics (9 2 1)

1. In the Packet Data sub-menu select **1 Sent**.

2. The number of KBytes sent since current packet data activation is displayed.

Sent Data:
100 KB

3. Press  to toggle the two screens.

Throughput: 9 kbps (e.g.) — active packet data session.

Throughput:
9 kbps

Throughput: N.A. — standby packet data session.

4. Press  to exit.

Viewing Received Data Statistics (9 2 2)

1. Select **2 Received** in the Packet Data sub-menu.

2. The number of KBytes received since current packet data activation is displayed.

Received Data:
100 KB

3. Press  to toggle the two screens.

Throughput: 9 kbps (e.g.) — active packet data session.

Throughput:
9 kbps

Throughput: N.A. — standby packet data session.

4. Press  to exit.

Viewing Bandwidth Status (9 2 3)

The bandwidth percentage represents the number of allocated time slots (“channels”) during the data session.

1. Select **3 Bandwidth** in the Packet Data sub-menu.

2. The bandwidth percentage is shown in steps:

75% (e.g.) — active packet data session,

N.A. — standby packet data session.

Bandwidth:
75%

NOTE

Your Service Provider has set the maximal number of time slots to allocate to 1, 2, 3, or 4. The bandwidth percentage refers to the possible number of slots (1, 2, 3, or 4) as 100%.

Example:

50% is displayed, if 2 of 4 possible slots are allocated.

100% is displayed, if 4 of 4 possible slots are allocated.

100% is displayed, if 1 of 1 possible slot is allocated.

3. Press  to exit.

Viewing Encryption Status ( 9 2 4)

1. Select **4 Encryption** in the Packet Data sub-menu.
2. The encryption state of the ongoing packet data session is displayed:
 - **Encrypted**
 - **Not Encrypted** (clear)
3. Press  to exit.

Packet Data
Encrypted

Messages

General

The messaging feature let you

- Send status messages.
- Send short text messages (free text or according to user defined or predefined templates).
- Receive text messages.

A status is a number corresponding to a pre-programmed message in a list your group recognises. A text message is a short text containing up to 140 characters.

NOTE

If configured by your Service Provider it is only possible to send a message to a private number that is stored in the Address Book.

Entering the Messages Sub-menu

To enter the Messages sub-menu, press  **-1 Messages**.

The sub-menu allows you to

- send status messages,
- read text messages, and
- send text messages.

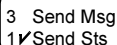

3 Send Msg
1 ✓ Send Sts

Scroll to your selection and press  to access the next display.

NOTE

Your MTM800 can receive calls while in the Messages sub-menu.

NOTE



- *It is not possible to send a status or text message in TXI Mode.*
- *It is not possible to send a status or text message during a call in DMO*

When a new message arrives, the  icon flashes on your display (The icon stops blinking when you enter the Inbox).

NOTE *If configured by your Service Provider, the MTM800 sounds the "New Mail Received" alert tone if a new message is received whilst your terminal is engaged in a call.*

Your MTM800 will enter the Inbox automatically and the  icon will not flash.

Sending a Status Message (1 1)

1. Switch to the desired talkgroup, to which you want to send a status message.
2. Press  from any mode, or press  - **1 Messages - 1 Send Sts.**
3. In this example, **Lunch** is the last sent status. If you wish to send a different status, scroll to your selection in the list of pre-programmed statuses, or key the status number. To stop scrolling, press . The display returns to the **Select Sts** screen.

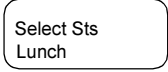

NOTE *From the status sub-menu it is also possible to type a valid 5 digit status number in the user status range.*

4. Press **PTT** to send the status message.

If your Service Provider has enabled the Targeted Status feature, pressing  gives you an option of sending your status as a private call or as a group call.

To enter the address for a private call, either key in the recipients number or scroll through the list of numbers, or press  to search the address book. For a group call, select the talkgroup within the attached range, then press **PTT** to send the status message.

The display will show one of the following delivery reports:

Status Sent — the screen exits the status mode.

Sts Failed — the screen returns within a few seconds to the previous display.

NOTE

Wait for the delivery report before sending a new status. If you enter the status menu from a busy talkgroup, the audio is momentarily suspended to allow transmission of your status message.

NOTE

If an emergency group call is received the terminal will immediately join that new emergency call.

NOTE

If set up by your Service Provider it is not possible to send a status message to a private number that is not in the Address Book.

Using the Inbox (1 2)

The Inbox list contains new or old incoming text messages. The Inbox list can contain up to 20 messages at any time.

To enter the Inbox, press  or  - **1 Messages - 2 Inbox**.

The status of the list is displayed for a few seconds:

- New message(s) arrived, and the list is full. Press  to confirm.
- New message(s) arrived — press any key or wait for a few seconds. The display shows the incoming message.
- No New or Old Messages — the screen returns to the previous display within a few seconds.

New Messages

The display shows the incoming message: its number, state (New), sender, and the first line of the text message.









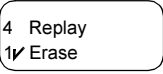

Press one of the following keys:

- The navigation keys to scroll quickly through text messages.
- Press  to read the entire message. Reading an existing text message changes its state from New to Old.

- The navigation keys to scroll through the content of a message that is longer than one display line (An arrow at the end indicates that the message continues).

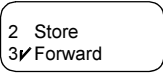
After reading the message, press  and:

- Scroll to **Erase** and press  to erase the message. The display shows the next message (if any) or the Messages sub-menu.
- Scroll to **Store** and press  to store the message as a template in the Template List. 
- Scroll to **Forward** and press  to invoke the Edit Mode. The old message body serves as the default message. Press **PTT** or  to initiate a call. Enter the recipient's number and press **PTT** to send.
- Scroll to **Reply** and press  to invoke the Edit Mode. The old message body serves as the default message and the message originator is the destination default. Press **PTT** to initiate a call to the message originator. 

Press  to return to the previous display.

The read message is kept in the Inbox.

A new text message will be displayed immediately. If this message is unread, further new messages can be viewed by re-entering the Inbox



Handling Old Messages

Scroll to one of the old text messages.

Press  and scroll to your selection:





1. Scroll to **Read** and press , to display the selected old message.

After reading the message, you can press  and then:



- Scroll to **Store** and press  to store the message as a template in the Template List. 

1 Old: Jerry
Lunch

3 EraseAll
1✓ Read

- Scroll to **Erase** and press  to erase the message. When the display shows **Message Erased**, the current message is deleted from the Inbox. The display shows the next message (if any) or the Messages sub-menu.
 - Scroll to **Forward** and press  to invoke the Edit Mode. The old message body serves as the default message and the message originator is the destination default. Press **PTT** to initiate a call.
 - Scroll to **Reply** and press  to invoke the Edit Mode. The old message body serves as the default message and the message originator is the destination default. Press **PTT** to initiate a call to the message originator.
2. Scroll to **Erase** and press  to erase the message.
 3. Scroll to **EraseAll** and press , the following message appears:

Erase Inbox?

 - Select  to erase all messages in the Inbox.
 - Select  to return to previous display.

Receiving Text Messages

When a new message arrives, the  icon flashes on your display. The icon stops blinking when you enter the Inbox.

The **New Mail Arrived** message is displayed for a few seconds.

If your Service Provider configured your MTM800 to “Manual Mode Switch” and a new message arrives, the MTM800 stays in the mode it was in before the message arrived. Press  **1 2** to enter the Inbox.

If your Service Provider configured your MTM800 to “Auto Mode Switch”, your MTM800 will enter the Inbox automatically and the  icon will not flash.

NOTE *For message alert, see settings in the Tones menu option (page 85).*

NOTE

If your service provider has enabled the PTT Callback feature, then pressing PTT a list containing the message originator (alias or number) and **ALL** the numbers found in the text message is displayed. Then it is possible to initiate a call to the selected one. Otherwise, PTT will be directed to the currently selected talkgroup.

NOTE

If configured by your Service Provider it is not possible to call back to a number that is not in the Address Book.

Sending a Text Message (1 3)

This feature allows you to send new messages, send messages based on user defined templates or send messages based on predefined templates.

The predefined templates are programmed into your MTM800 by your Service Provider. The user defined templates can be Inbox messages or, new Outbox messages that you choose to store in your MTM800 memory. User defined messages may also be programmed into your MTM800.

You are allowed to edit your messages before sending them.

You can send a message when the terminal is idle or during a Group/Emergency/Broadcast Call (if configured).

If configured, a message will alert you of an incoming Group/Emergency/Broadcast call, of your joining it, or of its end.

NOTE

In DMO text messages are sent on frequency attached to the current talkgroup. Make sure you selected desired talkgroup before sending a message. For selecting group details see "Selecting a Talkgroup" on page 29.

Receiving a Group/Emergency/Broadcast Call before or during text message editing

You can be in a call and start message editing while listening to the call.

Or you can start message editing, receive a call and listen to the call while editing the message.

To join a call received during message editing, press **PTT**.

Sending a text message during a Group Call (if configured)

Press **PTT**. One of the following might occur:

- The call started before message editing began. The terminal will leave the call and send the message. If the call is still active, the terminal will re-join it.
- The call started after message editing began. The terminal will leave the call and send the message. The terminal will return to edit mode.
- The call started before or after message editing began. The terminal will send the message while staying in the call.

Sending a text message during Emergency/Broadcast Call (if configured)

Press **PTT**. One of the following might occur:

- The call started before message editing began. The terminal will leave the call and send the message. The terminal will return to edit mode.
- The call started after message editing began. The terminal will send the message while staying in the call.

Receiving a Private/Phone/PABX Call during text message editing

Message editing is automatically interrupted and restored after that call.

Entering the Outbox

Press  - **1 Messages - 3 Send Msg.**

The “Send Msg” sub-menu is displayed.

3 Predefined
1 ✓ New

Editing, Storing, and Sending a New Message

1. Scroll to **1 New** and press . An empty screen will open. You are allowed to type or edit your message using the keypad. Refer to “Editing the Text” on page 16.

2. Press  and scroll to your selection:

- Scroll to **Send** and press .

This is a
new message

- If set up by your Service Provider you have the option to send the message to a private number or a talkgroup.
- Select the mail recipient of your choice by scrolling through the address list (see page 73) or enter the address directly.

1 Private
2 Group

Press **PTT** to send the message. The display will show one of the following delivery reports:

Message Delivered — to indicate that the message was successfully sent and received.

Message Failed — the message was not received.

- Scroll to **Store** and press  to add your message to the Template List (the number assigned to the message is the lowest free number - in this case template number 3).

Stored in
Template 3

NOTE

If provisioned by your Service Provider, it may be possible to compose and send text messages from a busy talkgroup. The group audio will be suspended when a new message or template is being edited. During this time it is possible to receive a new emergency call and message editing will be aborted. If a new private/telephone call is received the message will be restored after that call completes.





Sending, Editing, and Erasing a User Defined Template

The user defined mail templates are received, new, sent, or programmed messages that are stored in the Templates List and may be re-stored for sending.

1. Scroll to **2 Templates** and press . The first template in the Template List is displayed.

NOTE

It is possible that the templates numbers are not consecutive.

2. Scroll through the Templates List using the navigation keys and choose the required template.
3. Press  and scroll to your selection:
 - Scroll to **Send** and press  Select the mail recipient of your choice by scrolling through the address list (see page 73) or enter the address directly.
 - Press **PTT** to send the message. The display will show one of the following delivery reports:
 - Message Delivered** — to indicate that the message was successfully sent and received.
 - Message Failed** — the message was not received.
 - Scroll to **Edit** and press  to edit the message in the template for your needs. Refer to “Editing the Text” on page 16.
 - Scroll to **Erase** and press  to erase the current template.

Sending and Editing a Predefined Template

Predefined mail templates are templates that are programmed into your MTM800 by your Service Provider. You are allowed to perform limited edit operations of the predefined template and to send it, but you will not be able to store the edited template or erase it from the Templates List.

1. Scroll to **3 Predefined** and press .
The first template in the Predefined Template List is displayed (if no predefined template exist, the message **No Predefined** will be displayed).
2. Scroll through the Templates List using the navigation keys and choose the required template (in the example, a registration message is displayed).







Register:
abc 27

NOTE *A predefined message can only be sent from the Edit screen.*

3. Press . The message is now in the predefined message editor.

4. Enter your message.

- To move the cursor forward - press .
- To move the cursor backward - press .
- Press  to overwrite the character to the left of the cursor position with a "space" and then, to move the cursor to the left.
- At the present location of the cursor - press the required key to obtain the required character.
- In this editor - long press on the  key functions as "Caps Lock".

NOTE

A predefined message address is also defined by your Service Provider during programming and cannot be changed.

5. Press **PTT** to send the message. The display will show one of the following delivery reports:

Message Delivered — to indicate that the message was successfully sent and received.

Message Failed — the message was not received.

After sending the message, your MTM800 will return to the predefined template selection screen.

NOTE

You will not be able to send another message while your MTM800 is awaiting message acknowledge.

What to do if...









Your MTM800 flashes the following messages:

Messages	Message Description
.... Mode List Empty	There are no programmed entries in the scrolling list. Type the entry.
...-Rcvd	Call received but not answered, or rejected.
Attachment Failed	The terminal could not perform talkgroup attachment. Try another talkgroup.
Authenticate Failure	The terminal could not register on an Authenticated system (for example, the Authentication key is incorrect, or Authentication is disabled in the terminal).
Call Cancelled	Faulty channel. Please try later.
Call Ended	Faulty channel. Please try later. Called terminal ended the call.
Call Preempted	Channel being used for priority.
Emgcy Mic Ended	The Hot Microphone timer has automatically expired, or the user has pressed the PTT button to cancel the Hot Microphone feature.
Emgcy Mic On	The Hot Microphone feature is active, and the terminal is automatically transmitting hands free emergency audio.
Empty Entry	The speed number you dialled does not exist, or the number exists but the group is non-selectable.
Faulty Unit Error...	Self-test failed. An operational fault has been detected with your terminal. Record the error number. Turn your terminal off and contact service.
Group already exists	The group you are attempting to add already exists in the My Groups range.
Group Mode No Group	Check group selected, and not "No Group" selected. If correct group selected, attachment failed. Terminal detached from current talkgroup. Please wait until the terminal attaches again to the current talkgroup.
Invalid ID No Entry	The entered number is not valid.
Limited Service	Emergency Calls, Emergency Alarms and mobility operations (e.g.: group attachment) are allowed. All other incoming and outgoing call and data services are blocked
List not Attached	All talkgroups in the scan list are not attached.

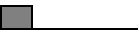
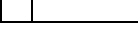
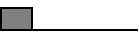

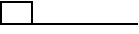

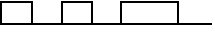









Messages	Message Description
List Partially Attached	The scan list is active, but not all talkgroups are attached to it.
Message Delivered	Mail successfully delivered.
Message Failed	Mail delivery failure.
Network Trouble	Network problems. Please try again later.
My Groups is empty	You cannot view/delete groups when the My Groups range is empty.
My Groups is full	You are not allowed to add a group to the My Groups range as it already contains the maximum allowed number of groups.
No Answer	The called party does not answer.
No Entries	Empty address book list.
No Group	<ul style="list-style-type: none"> • Displayed when you are out of the normal coverage area of your selected talkgroup. Please select a new talkgroup that is valid for your working location. • Indicates a favourite group was removed from the My Groups range.
No GPS Signal	Please check that the GPS antenna is properly connected and sufficient visibility of satellite is available.
No New or Old Messages	The Inbox is empty.
No Service	The terminal is out of coverage.
Not Allowed To Start Call	You are not allowed to dial a number which is not in the Address Book - if set up by your Service Provider.
Not Allowed To Transmit	<ul style="list-style-type: none"> • Release PTT and try again later. • You are not allowed to send a text message or a status message to a number which is not in the Address Book - if set up by your Service Provider.
Only One Entry	There is only one programmed entry in the scrolling list.
Overheating	The terminal will automatically turn off. Keep it turned off for five minutes.
Party Busy	The called terminal is busy.
Party Not Available	The called terminal is out-of-range. Please try again later. The called terminal is turned off. Please try again later.
Please Try Again	The MTM800 could not place the call.
Please Wait Connecting	A message during startup, or network reconnection.







Messages	Message Description
Registration Failure	The terminal could not register within the system. Please try again later. Please contact your Service Provider.
Service Denied	Invalid number. Call your Service Provider.
Service Not Available	This service is not available on the current network.
Service Restricted	This service has been restricted by your Service Provider or it has not been purchased.
Single Talkgrp	There is only one programmed entry in the scrolling list.
Talkgroup ... Added	Group name added to the favourite talkgroup range.
Try Again Later	The requested service is temporarily unavailable.
Unit Disabled	Check with Service Provider.
Unit is OK Warn...	Self-test error. A minor fault has been detected with your terminal. The terminal is still fully operative. Should this error recur, note the error code and contact service.
Unit Not Attached	The terminal could not attach to the system. The talkgroup may not be defined in the system. Please try another group.
Wait For Mic	The Hot Microphone feature is active, but the channel transmit grant has been given to another Emergency Call on the same talkgroup. The terminal microphone is not active during this time, but the terminal will automatically try to regain talk permit after a predetermined time.

Tones

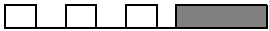
□ = High Tone; ■ = Low Tone		
Description	Type	Repeated
Idle		
<ul style="list-style-type: none"> • Back to Home display • Back to Rotary volume use when Rotary scroll timer expires • Back to coverage • Back to full service 		Once
Clear to send		Once
• Bad key press		Once
<ul style="list-style-type: none"> • Good key press • MTM800 self-test fails at power up • From out-of-service to in-service 		Once
In Call		
<ul style="list-style-type: none"> • Call clear warning • Call modified 		Once
Call waiting tone while Phone or Private Call are pending		Every 6 seconds, until a call is terminated
Data Connected or Data Disconnected.		Once
Talk Permit sounds upon pressing the PTT.		Once (Normal Tone)
		Once (Short Tone)
Talk Permit without gateway sounds upon pressing PTT. The tone indicates the gateway is no longer available.		Twice
		Once
<ul style="list-style-type: none"> • Talk Prohibit • System busy • Time-out timer expire • Called MTM800 not available or busy. 		Until you release the PTT

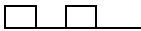
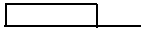
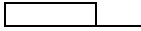
□ = High Tone; ■ = Low Tone

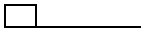
Description	Type	Repeated
Call disconnected or failed due to network		Once
Wrong number dialled.		No tone
DMO Entering		Once
DMO Exiting		Once
Local site trunking — Entering/Exiting		Once
Phone ring back (sending)		Every three seconds, until the called user answers or call is rejected
Phone busy		Every 0.5 seconds
Status message sent to the dispatcher or failed.		Twice
Incoming Calls		
Status message acknowledged by the dispatcher.		Four times
Your MTM800 received a Group Call without gateway. (setup only)		Once
High Priority Group Call received		Once
Emergency Alarm sent or received		Twice
Emergency Alarm failed		Four times
Emergency Call received		Once
Phone ring (reception) Full-duplex Private Call	According to the Ring Style sub-menu setting.	Until you answer or the call is rejected
Private Call received	According to the Ring Style sub-menu setting.	Until you answer or the call is rejected
Private Call ringing to the caller		Until the call is answered

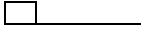
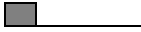
☐ = High Tone; ■ = Low Tone		
Description	Type	Repeated
Half-duplex Private Pre-emptive Priority Call (PPC) ring.		Every 4 seconds until the call is answered or rejected
Full-duplex Private PPC ring.		Every 4 seconds until the call is answered or rejected
Limited Service		Once upon entering limited service
New Mail Received		Once
New Group Call		Once
General		
Volume setting (earpiece, keypad, speaker)		Continuous
Volume setting (Ringer)		While setting the volume
Transmit Inhibit (TXI)		Once
Rotary knob tone		Once, when toggling from List to Volume
Low battery alert		Repeated
DTMF (0-9, #, *) during the call	DTMF 	Continuous, until the user releases the key
GPS		
GPS in coverage		Once
GPS out of coverage		Once

NOTE For the missed calls and unread messages, your Service Provider can set up periodic tone.

Index

A

- address book
 - adding a number 72
 - memory usage 74
 - phone address book 72
 - private address book 72
 - searching alphabetically 73
 - searching by location 73
- air encryption
 - key deletion 78
- air encryption key deletion 78
- AL (ambience listening) 24, 60
- alarm
 - horn & light 26
- alias 16
- alphanumeric key
 - entering numbers 15
 - entering text 16
 - text editing 16
- Ambience Listening (AL) 82
- ambience listening (AL) 24, 60
- announcement call 29
- announcement talkgroup (ATG) 29
- ATG (announcement talkgroup) 29
- available characters 17

B

- backlight
 - intensity 26
 - key 7
 - setting 82
- bandwidth 94
- BUP (busy user pre-emption) 21
- busy user pre-emption 21
- button/footswitch 38

C

- call queuing 53

- cleaning your radio 27
- code 76
- covert mode 12, 24
 - one-touch 18

D

- data setup 81
 - date
 - display settings 83
 - setting 84
 - DGNA (dynamic group number assignment) 37
 - dialing
 - last dialed number list 92
 - dialled call history 92
 - direct group call
 - making 44
 - receiving 47
 - direct mode operation (DMO) 13
 - display
 - long numbers 10
 - long text message 10
 - DMO 40
 - emergency 63
 - DMO (direct mode operation) 13
 - DMO SCK 79
 - DTMF
 - overdial 56
 - DTMF (dual-tone multifrequency) 56
 - dynamic group number assignment (DGNA) 37
- ## E
- emergency alarm 58
 - sending 61
 - emergency group call 58
 - making 61

- making in DMO 63
- receiving 63
- receiving in DMO 64

emergency switch, external 11

encryption 78

- air encryption 77

F

favourite talkgroup 28, 31, 91

full-duplex call 49

G

gateway 40, 42, 45

global positioning system (GPS) 65

GPS (global positioning system) 65

GPS enable/disable 67

group call

- making 33
- receiving 34

GW (gateway) 40

H

half-duplex call 49

home mode display 19

Hot Mic 62

hot microphone (Hot Mic) 58, 62

I

icons 9

- arrow 10
- data connected 10
- direct mode 9
- DMO gateway 9
- emergency 10
- external alarm 9
- incoming private call 10
- new message received 9
- phone call 10
- scan 10
- signal strength DMO 9
- signal strength TMO 9

ignition sense 11

intensity, display intensity 26

InterMNI call 40

internet protocol (IP) 27

IP (internet protocol) 27

K

K (key) 78

key

- backlight 7
- emergency 15
- menu 14

keypad

- locking 77

L

language

- display language 81

last number redial 50

local area service 22

- entering 25
- exiting 25

local site trunking 25

M

menu 14, 69

menu option 69

- list 70, 71

message 96

- erase 99
- forward 100
- reply 99, 100
- status 97
- status message 96
- text 98
- text message 96

missed call history 92

missed calls 92

MSPD (multi slot packed data) 27

multi slot packed data (MSPD)

- service 27

N

network 88
non-tactical call 59
notation 5
number dialing 20

O

offset
 setting 84
one-touch
 covert mode 18
one-touch feature 18
open group 40
own number 87

P

PABX (private automatic branch exchange) 54
packet data (PD) service 27
PD (packet data) 27
phone call
 answering 56
 direct dial 55
 last number redial 55
 list scroll 56
 making 54
 speed dial 55
phone mode 54
phone number 16, 54
 viewing and modifying 87
phone or private number
 editing 87
PIN (personal identification number) 76
power status indicator 11
powering on/off 11
PPC (pre-emptive priority call) 22
pre-emptive priority call 22
priority 91
private automatic branch exchange (PABX) 54

private call 49
 receiving 51
private full-duplex call 49
private half-duplex call 50
private number 16
 direct entry 50
 entering 50
 list scroll 50
 viewing 87
PUK (personal unblocking key) 76

R

range 28
received call history 92
receiving calls 21
recent calls 92
repeater 40, 43
ring style 81

S

scan list 28
SCK (static cipher key) 79
short number dial 50
shortcut 69
 menu and sub-menu 5, 15
speed dial 55
speed number 30
status message
 sending 97

T

tactical call 59
talk permit tone 86
talkgroup 28
 change 29
 speed number 30
targeted status 97
template 96
 predefined 104
 user defined 103
terminal disable/enable 19
throughput 94

time

display settings *83*

setting *84*

TMO (trunked mode operation) *13*

tone

setting *85*

Tones *109*

transmit inhibit (TXI) *12, 36*

trunked mode operation (TMO) *13*

TXI (transmit inhibit) *36*

V

volume

adjusting *26*

Vox Control *20*



MTM800 Motorcycle Radio Quick Reference Guide

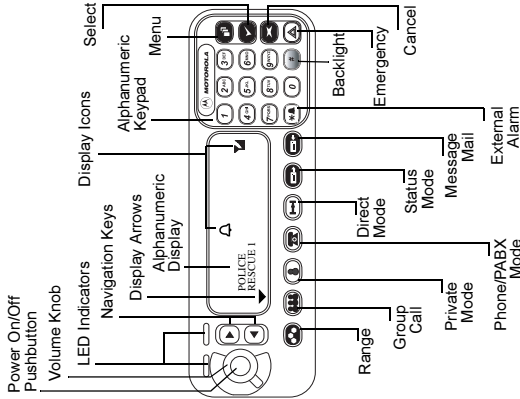

Making a Phone/PABX Call

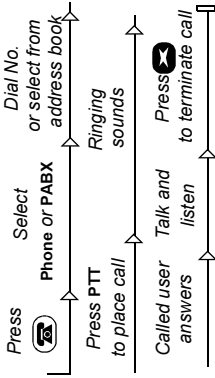

Making a TMO Private Call

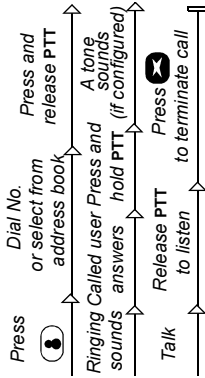

Making a TMO Private Full-duplex Call

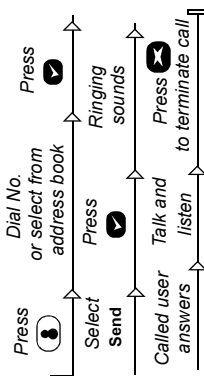

Making a DMO Private Call

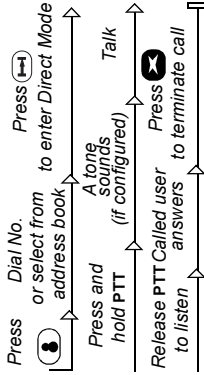

Making a TMO or DMO Group Call

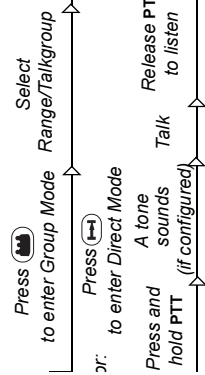

Making an Emergency Group Call (in TMO Mode)

Press and hold Emergency Alarm is sent automatically.
 While in Emergency Mode, press and hold **PTT** to talk. If using Hot Mic feature, wait for the **Emergency Mic** On message to be displayed, and talk without pressing **PTT**.
 To exit Emergency Mode press and hold

Answering a Call

Your MTM800 switches to the mode of the incoming call and starts ringing. To answer the call, press **PTT**.

Sending a Status Message

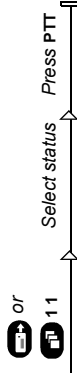

Sending a New Message

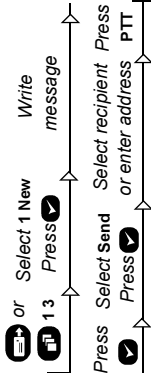

Sending a User defined Message

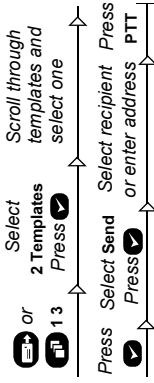

Sending a Predefined Message

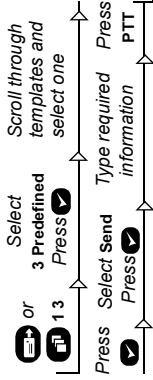

Handling New Incoming Text Messages

The icon will flash on your display and the MTM800 sounds a tone. For details see the Menu Messages section in the User Guide.

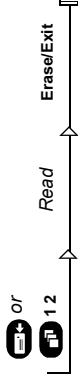

Handling Old Messages

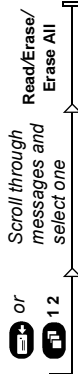

Last Number Redial

Press **PTT** to call the last called number.

Using the Menu

- Entering the menu: Press .
- Scrolling through the menu: Press or .
- Selecting a menu option: Press .
- Exiting the menu: Press .

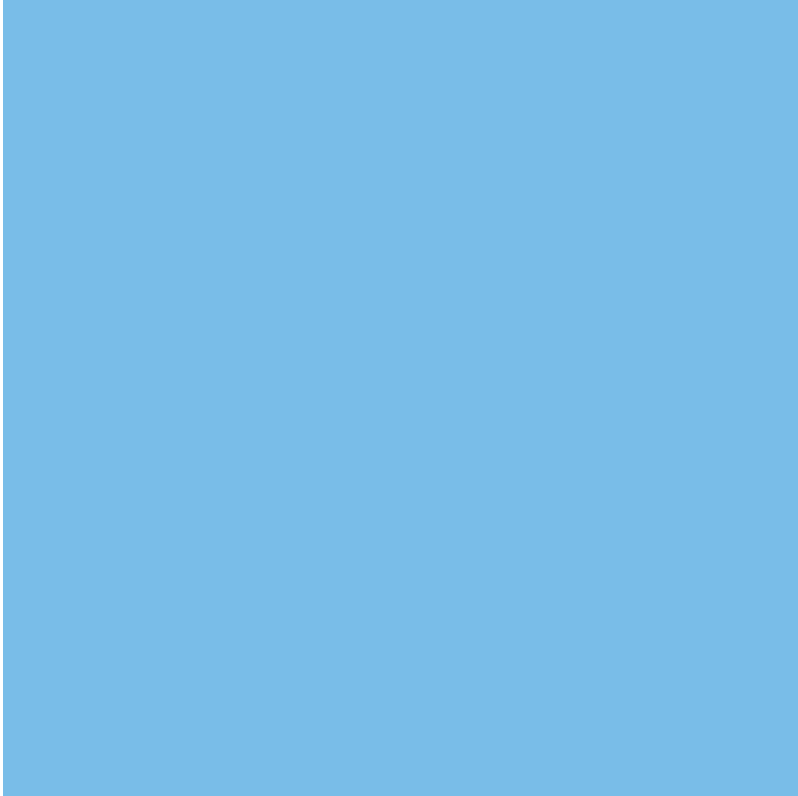

MOTOROLA

www.motorola.com/tetra

6866537D70-F

