

# APX™ TWO-WAY RADIOS

APX 5500, APX 6500, APX 6500Li, APX 7500, and APX 8500

# APX Mobile E5 Control Head User Guide

**APRIL 2024**

© 2024 Motorola Solutions, Inc. All Rights Reserved.



MN006147A01-AM

# Contents

<b>List of Figures</b> .....	<b>10</b>
<b>List of Tables</b> .....	<b>11</b>
<b>Legal and Support</b> .....	<b>12</b>
Intellectual Property and Regulatory Notices.....	12
Legal and Compliance Statements.....	13
Disclaimer.....	13
Declaration of Conformity.....	13
Important Safety Information.....	14
Notice to Users (FCC).....	14
FCC Licensing Information.....	15
Applying for Canadian License.....	15
Maritime Radio Use in the VHF Frequency Range.....	16
Emergency Channel.....	16
Non-Commercial Call Channel.....	16
Operating Frequency Requirements.....	16
Declaration of Compliance for the Use of Distress and Safety Frequencies.....	19
Technical Parameters for Interfacing External Data Sources.....	19
Limited Warranty.....	19
I. WHAT THIS WARRANTY COVERS AND FOR HOW LONG:.....	19
II. GENERAL PROVISIONS:.....	20
III. STATE LAW RIGHTS:.....	20
IV. HOW TO GET WARRANTY SERVICE:.....	20
V. WHAT THIS WARRANTY DOES NOT COVER:.....	20
VI. PATENT AND SOFTWARE PROVISIONS:.....	21
VII. GOVERNING LAW:.....	22
VIII. For Australia Only.....	22
SERVICE.....	22
<b>Chapter 1: Read Me First</b> .....	<b>23</b>
1.1 Software Version.....	23
<b>Chapter 2: Radio Care</b> .....	<b>24</b>
2.1 Cleaning the External Surface of the Radio.....	24
<b>Chapter 3: Radio Overview</b> .....	<b>25</b>
3.1 Programmable Radio Functions.....	26
3.2 Programmable Button Configurations for Gun Lock.....	30
3.2.1 Unlocking All Gun Locks.....	31

3.3 ViQi.....	31
3.3.1 Using ViQi Virtual Partner.....	32
<b>Chapter 4: Getting Started.....</b>	<b>33</b>
4.1 Turning the Radio On or Off.....	33
Turning the Radio On.....	33
Turning the Radio Off.....	33
4.2 Validating Compatibility During Power Up.....	33
4.3 Adjusting the Volume.....	34
<b>Chapter 5: Home Screen Overview.....</b>	<b>35</b>
5.1 Status Indicators.....	35
5.1.1 Status Icons.....	35
5.1.2 Call Type Icons.....	38
5.1.3 TMS Status Icons.....	38
5.1.4 Text Entry Icons.....	39
5.1.5 LED Indications.....	39
5.1.6 Intelligent Lighting Indicators .....	40
5.1.7 Channel Color Backlight.....	41
5.2 Alert Tones .....	41
<b>Chapter 6: General Radio Operation.....</b>	<b>43</b>
6.1 Selecting Zones.....	43
6.2 Selecting Channels.....	43
6.3 Mode Select Feature.....	44
6.3.1 Saving Zones and Channels.....	44
6.4 Channel Change on Off-Hook.....	45
6.5 Selecting the Power Level.....	45
6.6 Selecting Radio Profile.....	45
6.7 Controlling the Display Backlight.....	46
6.8 Turning the Keypad Tones On or Off.....	46
6.9 Turning Voice Mute On or Off.....	46
6.10 Using the Time-Out Timer.....	47
6.11 Conventional Squelch Operation.....	47
6.11.1 Setting Conventional Squelch Operation.....	48
6.12 Using the PL Defeat Feature.....	48
6.13 Digital PTT ID Support .....	48
6.14 External Alarms (Horn and Lights).....	48
6.14.1 Using Non-Permanent Horn and Lights.....	49
6.14.2 Using Permanent Horn and Lights.....	49
6.14.3 Changing the Selected Alarms.....	49

6.14.4 Incoming Calls While Alarms are Turned On.....	49
6.14.5 Turning Off Non-Rearmable External Alarms.....	50
6.14.6 Turning Off Rearmable External Alarms.....	50
6.15 Universal Relay Controller.....	50
6.16 Low Voltage Threshold Warning.....	51
<b>Chapter 7: Trunking System Controls .....</b>	<b>52</b>
7.1 Operating in Failsoft System.....	52
7.2 Imbalanced Coverage.....	52
7.3 Out-of-Range Radio.....	52
7.4 SmartZone.....	52
7.5 Site Trunking Feature.....	53
7.6 Site Search.....	53
7.7 Locking or Unlocking Sites.....	53
7.8 Viewing the Current Site.....	53
7.9 Changing the Current Site.....	54
7.10 Trunked Announcement.....	54
7.10.1 Initiating Announcements.....	54
<b>Chapter 8: Types of Radio Calls.....</b>	<b>55</b>
8.1 Making Calls.....	55
8.2 Receiving Calls.....	57
8.3 Making Priority Dispatch Calls.....	58
<b>Chapter 9: Emergency Operation.....</b>	<b>60</b>
9.1 Special Considerations for Emergency Operation.....	60
9.2 Sending Emergency Alarms.....	61
9.3 Sending Emergency Calls (Trunking Only).....	61
9.4 Sending Emergency Alarms with Emergency Calls.....	61
9.5 Sending Emergency Calls with Hot Mic (Trunking Only).....	62
9.6 Sending Emergency Alarms and Calls with Hot Mic.....	62
9.7 Exiting Emergency Operation.....	63
9.8 Remote Emergency.....	64
9.8.1 Sending Remote Emergency to Specific Users.....	64
9.8.2 Sending Remote Emergency by Entering the User ID.....	65
9.8.3 Manually Refreshing the Remote Emergency List.....	65
9.8.4 Receiving Remote Emergency.....	65
9.9 Impact Detection.....	65
9.9.1 Impact Detected Condition.....	66
9.9.2 Exiting Impact Detected Condition.....	66
9.10 Sending Evacuation Tones.....	66

<b>Chapter 10: Ignition Switch Options.....</b>	<b>67</b>
10.1 Using Emergency Power Up.....	67
<b>Chapter 11: Secure Operations.....</b>	<b>69</b>
11.1 Enabling Secure Transmissions.....	69
11.2 Encryption.....	69
11.2.1 Multikey Feature.....	69
11.2.2 MDC OTAR (Conventional Only).....	70
11.2.3 Infinite UKEK Retention.....	70
11.2.4 Hear Clear.....	70
11.2.5 Loading Encryption Keys.....	71
11.2.6 Selecting Encryption Keys.....	71
11.2.7 Selecting Keysets.....	71
11.2.8 Erasing Encryption Keys.....	72
11.2.9 Requesting Over-the-Air Rekey.....	72
<b>Chapter 12: Scan.....</b>	<b>73</b>
12.1 Turning Scan On or Off.....	73
12.2 Turning Scan On While Disregarding the Squelch Code (Conventional Channels Only).....	73
12.3 Deleting Nuisance Channel.....	73
12.4 Restoring Nuisance Channels.....	74
12.5 Changing Priorities Status While Scan is On.....	74
12.6 Using the Hang Up Box.....	74
<b>Chapter 13: Scan Lists.....</b>	<b>75</b>
13.1 Managing the Scan List.....	75
13.2 Changing the Scan List Status.....	76
13.3 Restoring Priorities in Scan Lists.....	76
13.4 Intelligent Priority Scan.....	76
<b>Chapter 14: Connectivity.....</b>	<b>77</b>
14.1 SmartConnect.....	77
14.2 Wi-Fi.....	77
14.2.1 Turning Wi-Fi On or Off.....	78
Turning Wi-Fi On.....	78
Turning Wi-Fi Off.....	78
14.2.2 Selecting Wi-Fi Network.....	78
14.2.3 Checking the Wi-Fi Configuration and Status of the Radio.....	78
14.3 Bluetooth®.....	79
14.3.1 Turning Bluetooth On or Off.....	79
14.3.2 Pairing with Low Frequency-Motorola Proximity Pairing (LF-MPP) Feature.....	79
14.3.3 Standard Pairing Feature.....	80

14.3.3.1 Searching and Pairing Bluetooth Devices.....	80
14.3.3.2 Turning Bluetooth Visibility On or Off.....	81
14.3.3.3 Receiving Pairing Request from Other Devices.....	81
14.3.4 PIN Authentication in Pairing.....	81
14.3.4.1 Pairing the Authentication PIN when Receiving a Pairing Request.....	81
14.3.4.2 Pairing the Authentication PIN with the Generated Numeric PIN.....	82
14.3.5 Turning Bluetooth Audio On or Off.....	83
14.3.6 Adjusting the Volume of the Radio from the Bluetooth Audio Device.....	83
14.3.7 Viewing and Clearing the Bluetooth Enabled Device Information.....	84
14.3.8 Clearing All Bluetooth Devices Information.....	84
14.3.9 Editing the Bluetooth Friendly Name.....	84
14.4 ASTRO 25 (P25) Programming Over Project 25 (POP25).....	85
14.4.1 Responding to Upgrade Notifications.....	85
<b>Chapter 15: Location .....</b>	<b>86</b>
15.1 Outdoor Location Feature.....	86
15.1.1 Turning Location On or Off.....	87
15.1.2 Accessing Location.....	87
15.2 Location Format.....	87
15.3 Managing Waypoints.....	88
15.4 Location Feature in Emergency Mode.....	90
15.5 Peer-Location on the Display (ASTRO Conventional).....	90
<b>Chapter 16: Mission Critical Geofence (ASTRO 25 Trunking).....</b>	<b>91</b>
16.1 Entry to the Geofence Area.....	91
16.2 Entry to Mission Critical Geofence.....	92
16.3 Exit from Mission Critical Geofence.....	92
<b>Chapter 17: Contacts.....</b>	<b>93</b>
17.1 Managing Contact Entries.....	93
<b>Chapter 18: Recent Calls.....</b>	<b>95</b>
18.1 Viewing Recent Calls.....	95
18.2 Deleting Calls.....	95
<b>Chapter 19: Instant Recall.....</b>	<b>97</b>
19.1 Saving and Playing Back Calls.....	97
<b>Chapter 20: In-Call User Alert.....</b>	<b>98</b>
20.1 Enabling or Disabling In-Call User Alert.....	98
<b>Chapter 21: Quik Call II.....</b>	<b>99</b>
21.1 Initiating Quik Call II Transmissions.....	99
<b>Chapter 22: Status.....</b>	<b>100</b>
22.1 Sending Status.....	100

<b>Chapter 23: Message</b> .....	<b>101</b>
23.1 Sending Messages.....	101
<b>Chapter 24: Call Alert Paging</b> .....	<b>102</b>
24.1 Sending Call Alert Page.....	102
24.2 Receiving Call Alert Page.....	103
<b>Chapter 25: Automatic Registration Service</b> .....	<b>104</b>
25.1 Selecting ARS Mode.....	104
<b>Chapter 26: User Login Feature</b> .....	<b>105</b>
26.1 Logging In as a User.....	105
26.2 Logging Out.....	106
<b>Chapter 27: Text Messaging Service</b> .....	<b>107</b>
27.1 Viewing Text Messages.....	107
27.2 Composing New Text Messages.....	108
27.3 Sending Text Messages.....	108
27.4 Priority Status and Request Reply for New Text Messages.....	109
27.4.1 Appending Priority Status and Request Reply to Text Messages.....	109
27.4.2 Removing Priority Status and Request Reply from Text Messages.....	110
27.5 Receiving Text Messages.....	110
27.6 Replying to Text Messages.....	111
27.7 Accessing the Drafts Folder.....	111
27.8 Deleting Text Messages.....	112
<b>Chapter 28: Monitor Feature</b> .....	<b>113</b>
28.1 Monitoring Channels.....	113
28.2 Monitoring Conventional Mode.....	113
<b>Chapter 29: Remote Monitor</b> .....	<b>115</b>
<b>Chapter 30: Transmit Inhibit</b> .....	<b>116</b>
30.1 Enabling or Disabling Transmit Inhibit.....	116
30.2 Smart PTT (Conventional Only).....	117
<b>Chapter 31: Dynamic Regrouping (Trunking Only)</b> .....	<b>118</b>
31.1 Classification of Regrouped Radios.....	118
31.2 Requesting a Reprogram (Trunking Only).....	118
<b>Chapter 32: Dynamic Zone Programming</b> .....	<b>119</b>
32.1 Saving Channels in the Dynamic Zone.....	119
32.2 Deleting Channels in the Dynamic Zone.....	119
<b>Chapter 33: Zone-to-Zone Cloning</b> .....	<b>120</b>
33.1 Cloning Zones.....	120
<b>Chapter 34: Multiple Private Line</b> .....	<b>122</b>

34.1 Selecting Multiple Private Line.....	122
<b>Chapter 35: Multiple Control Head Features.....</b>	<b>123</b>
35.1 Setting the ID of the Initial Control Head.....	123
35.2 All Active Mode.....	123
35.2.1 Activating or Deactivating Intercom in All Active Mode.....	124
35.3 One Active Mode.....	124
<b>Chapter 36: Action Consolidation Mode.....</b>	<b>125</b>
36.1 Activating the Action Consolidation Activities.....	125
36.2 Deactivating the Action Consolidation Activities.....	125
<b>Chapter 37: Front Panel Programming.....</b>	<b>127</b>
37.1 Initiating the FPP Feature.....	127
37.2 Changing Password (Optional).....	127
37.3 Viewing the List of Channel Parameters.....	128
37.4 Editing Channel Parameters.....	128
<b>Chapter 38: Radio Lock.....</b>	<b>132</b>
38.1 Enabling or Disabling Radio Lock (Secure Radios Only).....	132
38.2 Changing the Radio Lock Password.....	132
38.3 Changing the Tactical Inhibit Password.....	133
<b>Chapter 39: Radio Stun.....</b>	<b>134</b>
39.1 Using Radio Stun.....	134
<b>Chapter 40: Radio Kill .....</b>	<b>135</b>
40.1 Using Remote Kill to Kill Another Radio.....	135
40.2 Using Direct Kill to Kill Your Own Radio.....	135
<b>Chapter 41: Radio Inhibit.....</b>	<b>136</b>
<b>Chapter 42: Voice Announcement .....</b>	<b>137</b>
<b>Chapter 43: Site Selectable Alerts (ASTRO 25 Trunking) .....</b>	<b>138</b>
43.1 Sending Site Selectable Alert Notifications.....	138
43.2 Stopping Site Selectable Alert Notifications.....	139
<b>Chapter 44: Switching Between Repeater or Direct Operation Button.....</b>	<b>140</b>
<b>Chapter 45: Additional Performance Enhancement.....</b>	<b>141</b>
45.1 ASTRO 25 Enhanced Data.....	141
45.2 Dynamic System Resilience.....	141
45.3 CrossTalk Prevention.....	141
45.4 Encrypted Integrated Data.....	141
45.5 SecureNet.....	141
45.6 Over-the-Air Rekeying.....	141
45.7 P25 Digital Vehicular Repeater System.....	142



45.7.1 Accessing the DVRS..... 142

45.8 Conventional Talkgroup and Radio Scan Enhancements..... 142

**Chapter 46: Accessories..... 144**

# List of Figures

Figure 1: E5 Control Head and Microphone.....	25
Figure 2: Home Screen Display.....	35
Figure 3: APX E5 Control Head Home Screen with Channel Color Backlight Feature.....	41

# List of Tables

Table 1: VHF Marine Channel List.....	17
Table 2: E5 Control Head and Microphone Callouts.....	25
Table 3: Programmable Radio Functions.....	26
Table 4: ViQi Virtual Partner Queries.....	31
Table 5: Home Screen Overview Description.....	35
Table 6: Call Type Icons.....	38
Table 7: TMS Status Icons.....	38
Table 8: Text Entry Modes.....	39
Table 9: LED Indications.....	40
Table 10: Emergency Operation Scenarios.....	60
Table 11: Pairing the Authentication PIN when Receiving a Pairing Request Scenario.....	82
Table 12: Multisource Zones Selection Indications.....	120
Table 13: MPL Selection Mode.....	122

# Legal and Support

## Intellectual Property and Regulatory Notices

### Copyrights

The Motorola Solutions products described in this document may include copyrighted Motorola Solutions computer programs. Laws in the United States and other countries preserve for Motorola Solutions certain exclusive rights for copyrighted computer programs. Accordingly, any copyrighted Motorola Solutions computer programs contained in the Motorola Solutions products described in this document may not be copied or reproduced in any manner without the express written permission of Motorola Solutions.

No part of this document may be reproduced, transmitted, stored in a retrieval system, or translated into any language or computer language, in any form or by any means, without the prior written permission of Motorola Solutions, Inc.

### Trademarks

MOTOROLA, MOTO, MOTOROLA SOLUTIONS, and the Stylized M Logo are trademarks or registered trademarks of Motorola Trademark Holdings, LLC and are used under license. All other trademarks are the property of their respective owners.

### License Rights

The purchase of Motorola Solutions products shall not be deemed to grant either directly or by implication, estoppel or otherwise, any license under the copyrights, patents or patent applications of Motorola Solutions, except for the normal nonexclusive, royalty-free license to use that arises by operation of law in the sale of a product.

### Open Source Content

This product may contain Open Source software used under license. Refer to the product installation media for full Open Source Legal Notices and Attribution content.

### European Union (EU) and United Kingdom (UK) Waste of Electrical and Electronic Equipment (WEEE) Directive



The European Union's WEEE directive and the UK's WEEE regulation require that products sold into EU countries and the UK must have the crossed-out wheellie bin label on the product (or the package in some cases). As defined by the WEEE directive, this crossed-out wheellie bin label means that customers and end users in EU and UK countries should not dispose of electronic and electrical equipment or accessories in household waste.

Customers or end users in EU and UK countries should contact their local equipment supplier representative or service center for information about the waste collection system in their country.

### Disclaimer

Please note that certain features, facilities, and capabilities described in this document may not be applicable to or licensed for use on a specific system, or may be dependent upon the characteristics of a specific mobile subscriber unit or configuration of certain parameters. Please refer to your Motorola Solutions contact for further information.

© 2024 Motorola Solutions, Inc. All Rights Reserved

## Legal and Compliance Statements

### Disclaimer

The information in this document is carefully examined, and is believed to be entirely reliable. However, no responsibility is assumed for inaccuracies.

Furthermore, Motorola Solutions reserves the right to change any products to improve readability, function, or design. Motorola Solutions does not assume any liability arising out of the applications or use of any product or circuit described herein; nor does it cover any license under its patent rights, nor the rights of others.

### Declaration of Conformity

Per FCC CFR 47 Part 2 Section 2.1077(a)



Responsible Party

Name: Motorola Solutions, Inc.

Address: 2000 Progress Pkwy, Schaumburg, IL 60196-1078, U.S.A.

Phone Number: 1-800-927-2744

Hereby declares that the product:

Model Name: **APX Mobile**

conforms to the following regulations:

FCC Part 15, subpart B, section 15.107(a), 15.107(d), and section 15.109(a)

#### **Class B Digital Device**

As a personal computer peripheral, this device complies with Part 15 of the FCC Rules. Operation is subject to the following two conditions:

1. This device may not cause harmful interference, and

2. This device must accept any interference received, including interference that may cause undesired operation.



**NOTE:**

This equipment has been tested and found to comply with the limits for a Class B digital device, pursuant to part 15 of the FCC Rules. These limits are designed to provide reasonable protection against harmful interference in a residential installation. This equipment generates, uses, and can radiate radio frequency energy and, if not installed and used in accordance with the instructions, may cause harmful interference to radio communications. However, there is no guarantee that interference will not occur in a particular installation.

If this equipment does cause harmful interference to radio or television reception, which can be determined by turning the equipment off and on, the user is encouraged to try to correct the interference by one or more of the following measures:

- Reorient or relocate the receiving antenna.
- Increase the separation between the equipment and receiver.
- Connect the equipment into an outlet on a circuit different from that to which the receiver is connected.
- Consult the dealer or an experienced radio or TV technician for help.

## Important Safety Information

### RF Energy Exposure and Product Safety Guide for Mobile Two-Way Radios



**ATTENTION:**

**This radio is restricted to Occupational use only.**

Before using the radio, read the RF Energy Exposure and Product Safety Guide for Mobile Two-Way Radios which contains important operating instructions for safe usage and RF energy awareness and control for Compliance with applicable standards and Regulations.

For a list of Motorola Solutions-approved antennas and other accessories, visit:

<https://www.motorolasolutions.com>

*Any modification to this device, not expressly authorized by Motorola Solutions, may void your authority to operate this device.*

*Under Innovation, Science, and Economic Development Canada (ISED) regulations, this radio transmitter may only operate using an antenna of a type and maximum (or lesser) gain approved for the transmitter by ISED. To reduce potential radio interference to other users, the antenna type and its gain should be so chosen that the equivalent isotropically radiated power (e.i.r.p.) is not more than that necessary for successful communication.*

*This radio transmitter is approved by ISED to operate with a Motorola Solutions-approved antenna with the maximum permissible gain and required antenna impedance for each antenna type indicated. Antenna types not included in this list, having a gain greater than the maximum gain indicated for that type, are strictly prohibited for use with this device.*



**NOTE:** Setting up the radio as an RF Modem takes complete control of the radio. In this mode, the radio no longer responds to button and **PTT** presses nor will it unmute to voice activity. This mode is designed to receive and pass formatted over-the-air data to a tethered computer with RF modem enabled applications. This mode can only be exit by reprogramming the radio with Customer Programming Software (CPS) to not operate in RF modem mode and cycling power.

## Notice to Users (FCC)

This device complies with Part 15 of the FCC rules per the following conditions:

- This device may not cause harmful interference.
- The device must accept any interference received, including interference that may cause undesired operation.
- Changes or modifications made to this device, not expressly approved by Motorola Solutions, could void the authority of the user to operate this equipment.

## FCC Licensing Information

This device complies with Parts 90 and 15 of the Federal Communications Commission (FCC) Rules.

Operation is subject to the condition that this device does not cause harmful interference. The radio operates on radio frequencies that are regulated by the Federal Communications Commission (FCC). To transmit on these frequencies, you are required to have a license issued by the FCC. Application is made available on FCC Form 601 and Schedules D, H, and Remittance Form 159.

To obtain these FCC forms, request document 000601 which includes all forms and instructions. If you wish to have the document faxed, mailed, or have questions, use the following contact information.

### Fax

Contact the Fax-On-Demand system at 1-202-418-0177

### Mail

Call the FCC forms hotline at 1-800-418-FORM or 1-800-418-3676

### Contact

For questions regarding FCC license, contact 1-888-CALL-FCC, 1-888-225-5322, or <http://www.fcc.gov>.

Before filling out your application, you must decide which frequency you can operate on. For questions on determining the radio frequency, call Motorola Solutions Product Services at: 1-800-448- 6686. Changes or modifications not expressly approved by Motorola Solutions may void the user authority granted by the FCC to operate this radio and should not be made. To comply with FCC requirements, transmitter adjustments should be made only by or under the supervision of a person certified as technically qualified to perform transmitter maintenance and repairs in the private land mobile and fixed services as certified by an organization representative of the user of those services.

Replacement of any transmitter component such as crystal, semiconductor, and others not authorized by the FCC equipment authorization for this radio could violate FCC rules.



**NOTE:** Use of this radio outside the country where it was intended to be distributed is subject to government regulations and may be prohibited.

## Applying for Canadian License

The operation of your Motorola Solutions radio is subject to the Radio communications Act and must comply with rules and regulations of the Federal Government's department of Innovation, Science, and Economic Development Canada (ISED). ISED requires that all operators using Private Land Mobile frequencies obtain a radio license before operating their equipment.

**Prerequisites:** Obtain the latest Canadian License Application form at [http://www.ic.gc.ca/ic\\_wp-pa.htm](http://www.ic.gc.ca/ic_wp-pa.htm).

### Procedure:

1. Fill in the items as per the instructions. Be sure to print legibly.  
If you need additional space for any item, use the reverse side of the application.
2. Make a copy of your files.
3. Prepare a cheque or money order payable to the "Receiver General for Canada", for an amount for each radio purchased.

The license is renewed on April 1st each year, and issued for a period of 12 months.

4. Mail your completed application along with your cheque or money order to the closest ISED office.

## Maritime Radio Use in the VHF Frequency Range

### Special Channel Assignments

#### Emergency Channel

If you are in imminent and grave danger at sea and require emergency assistance, use VHF Channel 16 to send a distress call to nearby vessels and the United States Coast Guard. Transmit the following information, in this order:

1. "MAYDAY, MAYDAY, MAYDAY."
2. "THIS IS \_\_\_\_\_, CALL SIGN \_\_\_\_\_." State the name of the vessel in distress 3 times, followed by the call sign or other identification of the vessel, stated 3 times.
3. Repeat "MAYDAY" and the name of the vessel.
4. "WE ARE LOCATED AT \_\_\_\_\_." State the position of the vessel in distress, using any information that will help responders to locate you, e.g.:
  - latitude and longitude
  - bearing (state whether you are using true or magnetic north)
  - distance to a well-known landmark
  - vessel course, speed, or destination
5. State the nature of the distress.
6. Specify what kind of assistance that you need.
7. State the number of persons on board and the number needing medical attention, if any.
8. Mention any other information that would be helpful to responders, such as type of vessel, vessel length and/or tonnage, hull color, etc.
9. "OVER."
10. Wait for a response.
11. If you do not receive an immediate response, remain by the radio, and repeat the transmission at intervals until you receive a response. Be prepared to follow any instructions given to you.

#### Non-Commercial Call Channel

For non-commercial transmissions, such as fishing reports, rendezvous arrangements, repair scheduling, or berthing information, use **VHF Channel 9**.

#### Operating Frequency Requirements

A radio designated for shipboard use must comply with Federal Communications Commission Rule Part 80 as follows:

- on ships subject to Part II of Title III of the Communications Act, the radio must be capable of operating on the 156.800 MHz frequency.
- on ships subject to the Safety Convention, the radio must be capable of operating:



- in the simplex mode on the ship station transmitting frequencies specified in the 156.025–157.425 MHz frequency band, and
- in the semiduplex mode on the two frequency channels specified in the table below.



**NOTE:**

Simplex channels 3, 21, 23, 61, 64, 81, 82, and 83 cannot be lawfully used by the general public in US waters.

Additional information about operating requirements in the Maritime Services can be obtained from the full text of FCC Rule Part 80 and from the US Coast Guard.

**Table 1: VHF Marine Channel List**

Channel Number	Frequency (MHz)	
	Transmit	Receive
1	156.050	160.650
2	156.100	160.700
*	156.150	160.750
4	156.200	160.800
5	156.250	160.850
6	156.300	–
7	156.350	160.950
8	156.400	–
9	156.450	156.450
10	156.500	156.500
11	156.550	156.550
12	156.600	156.600
13**	156.650	156.650
14	156.700	156.700
15**	156.750	156.750
16	156.800	156.800
17**	156.850	156.850
18	156.900	161.500
19	156.950	161.550
20	157.000	161.600
*	157.050	161.650
22	157.100	161.700
*	157.150	161.750
24	157.200	161.800
25	157.250	161.850
26	157.300	161.900
27	157.350	161.950

28	157.400	162.000
60	156.025	160.625
*	156.075	160.675
62	156.125	160.725
63	156.175	160.775
*	156.225	160.825
65	156.275	160.875
66	156.325	160.925
67**	156.375	156.375
68	156.425	156.425
69	156.475	156.475
71	156.575	156.575
72	156.625	–
73	156.675	156.675
74	156.725	156.725
75	***	***
76	***	***
77**	156.875	–
78	156.925	161.525
79	156.975	161.575
80	157.025	161.625
*	157.075	161.675
*	157.125	161.725
*	157.175	161.775
84	157.225	161.825
85	157.275	161.875
86	157.325	161.925
87	157.375	161.975
88	157.425	162.025



**NOTE:**

\* Simplex channels 3, 21, 23, 61, 64, 81, 82, and 83 cannot be **lawfully used** by the general public in US waters.

\*\* Low power (1 W) only.

\*\*\* Guard band.



**NOTE:** A – in the Receive column indicates that the channel is transmitted only.

## Declaration of Compliance for the Use of Distress and Safety Frequencies

The radio equipment does not employ a modulation other than the internationally adopted modulation for maritime use when it operates on the distress and safety frequencies specified in RSS-182 Section 7.3.

## Technical Parameters for Interfacing External Data Sources

	<b>RS232</b>	<b>USB</b>	<b>SB9600</b>
<b>Input Voltage (Volts Peak-to-peak)</b>	18 V	3.6 V	5 V
<b>Max Data Rate</b>	115 Kbps	12 Mbps	9.6 Kbps
<b>Impedance</b>	5000 $\Omega$	90 $\Omega$	120 $\Omega$

## Limited Warranty

### MOTOROLA SOLUTIONS COMMUNICATION PRODUCTS

## I. WHAT THIS WARRANTY COVERS AND FOR HOW LONG:

MOTOROLA SOLUTIONS, INC. ("MOTOROLA") warrants the MOTOROLA SOLUTIONS manufactured Communication Products listed below ("Product") against defects in material and workmanship under normal use and service for a period of time from the date of purchase as scheduled below:

ASTRO APX Mobile Radios	One (1) Year
Product Accessories	One (1) Year

MOTOROLA SOLUTIONS, at its option, will at no charge either repair the Product (with new or reconditioned parts), replace it (with a new or reconditioned Product), or refund the purchase price of the Product during the warranty period provided it is returned in accordance with the terms of this warranty. Replaced parts or boards are warranted for the balance of the original applicable warranty period. All replaced parts of Product shall become the property of MOTOROLA SOLUTIONS.

This express limited warranty is extended by MOTOROLA SOLUTIONS to the original end user purchaser only and is not assignable or transferable to any other party. This is the complete warranty for the Product manufactured by MOTOROLA SOLUTIONS. MOTOROLA SOLUTIONS assumes no obligations or liability for additions or modifications to this warranty unless made in writing and signed by an officer of MOTOROLA SOLUTIONS.

Unless made in a separate agreement between MOTOROLA SOLUTIONS and the original end user purchaser, MOTOROLA SOLUTIONS does not warrant the installation, maintenance or service of the Product.

MOTOROLA SOLUTIONS cannot be responsible in any way for any ancillary equipment not furnished by MOTOROLA SOLUTIONS which is attached to or used in connection with the Product, or for operation of the Product with any ancillary equipment, and all such equipment is expressly excluded from this warranty. Because each system which may use the Product is unique, MOTOROLA SOLUTIONS disclaims liability for range, coverage, or operation of the system as a whole under this warranty.

MOTOROLA SOLUTIONS offers the following optional extended service contracts.

#### **DEVICE MANAGED SERVICES (DMS) ACCIDENTAL DAMAGE**

Provides for extended hardware repair coverage INCLUDING CHEMICAL, LIQUID, FIRE, AND OTHER PHYSICAL DAMAGE. Accidental damage coverage is available in conjunction with MOTOROLA SOLUTIONS'S standard Commercial Warranty and starts from the FIRST DAY the radio is put into use. Service performed under this plan consists of repair or replacement of the covered equipment as set forth in the terms and conditions. Repairs will be made only at the designated MOTOROLA SOLUTIONS repair depot. Local services are not included. MOTOROLA SOLUTIONS will pay the inbound shipping charges only with use of the MOTOROLA SOLUTIONS designated delivery service. MOTOROLA SOLUTIONS will pay for outbound shipping via MOTOROLA SOLUTIONS'S normal shipping methods.

#### **DEVICE MANAGED SERVICES (DMS) STANDARD HARDWARE**

Provides extended hardware normal wear and tear repair coverage beginning AFTER MOTOROLA SOLUTIONS'S standard Commercial Warranty period expires. Service performed under this plan consists of repair of the covered equipment as set forth in the terms and conditions. Repairs will be made only at the designated MOTOROLA SOLUTIONS repair depot. Local services are not included. MOTOROLA SOLUTIONS will pay for outbound shipping via MOTOROLA SOLUTIONS'S normal shipping methods.

## **II. GENERAL PROVISIONS:**

This warranty sets forth the full extent of MOTOROLA SOLUTIONS'S responsibilities regarding the Product. Repair, replacement, or refund of the purchase price, at MOTOROLA SOLUTIONS's option, is the exclusive remedy. THIS WARRANTY IS GIVEN IN LIEU OF ALL OTHER EXPRESS WARRANTIES. IMPLIED WARRANTIES, INCLUDING WITHOUT LIMITATION, IMPLIED WARRANTIES OF MERCHANTABILITY AND FITNESS FOR A PARTICULAR PURPOSE, ARE LIMITED TO THE DURATION OF THIS LIMITED WARRANTY. IN NO EVENT SHALL MOTOROLA SOLUTIONS BE LIABLE FOR DAMAGES IN EXCESS OF THE PURCHASE PRICE OF THE PRODUCT, FOR ANY LOSS OF USE, LOSS OF TIME, INCONVENIENCE, COMMERCIAL LOSS, LOST PROFITS OR SAVINGS OR OTHER INCIDENTAL, SPECIAL OR CONSEQUENTIAL DAMAGES ARISING OUT OF THE USE OR INABILITY TO USE SUCH PRODUCT, TO THE FULL EXTENT SUCH MAY BE DISCLAIMED BY LAW.

## **III. STATE LAW RIGHTS:**

SOME STATES DO NOT ALLOW THE EXCLUSION OR LIMITATION OF INCIDENTAL OR CONSEQUENTIAL DAMAGES OR LIMITATION ON HOW LONG AN IMPLIED WARRANTY LASTS, SO THE ABOVE LIMITATION OR EXCLUSIONS MAY NOT APPLY.

This warranty gives specific legal rights, and there may be other rights, which may vary from state to state.

## **IV. HOW TO GET WARRANTY SERVICE:**

You must provide proof of purchase (bearing the date of purchase and Product item serial number) in order to receive warranty service and, also, deliver or send the Product item, transportation and insurance prepaid, to an authorized warranty service location. Warranty service will be provided by MOTOROLA SOLUTIONS through one of its authorized warranty service locations. If you first contact the company which sold you the Product (e.g., dealer or communication service provider), it can facilitate your obtaining warranty service. You can also call MOTOROLA SOLUTIONS at 1-800-927-2744 US/Canada.

## **V. WHAT THIS WARRANTY DOES NOT COVER:**

1. Defects or damage resulting from use of the Product in other than its normal and customary manner.
2. Defects or damage from misuse, accident, water, or neglect.

3. Defects or damage from improper testing, operation, maintenance, installation, alteration, modification, or adjustment.
4. Breakage or damage to antennas unless caused directly by defects in material workmanship.
5. A Product subjected to unauthorized Product modifications, disassembles, or repairs (including, without limitation, the addition to the Product of non-MOTOROLA SOLUTIONS supplied equipment) which adversely affect performance of the Product or interfere with MOTOROLA SOLUTIONS's normal warranty inspection and testing of the Product to verify any warranty claim.
6. Product which has had the serial number removed or made illegible.
7. Rechargeable batteries if:
  - any of the seals on the battery enclosure of cells are broken or show evidence of tampering.
  - the damage or defect is caused by charging or using the battery in equipment or service other than the Product for which it is specified.
8. Freight costs to the repair depot.
9. A Product which, due to illegal or unauthorized alteration of the software/firmware in the Product, does not function in accordance with MOTOROLA SOLUTIONS's published specifications or the FCC certification labeling in effect for the Product at the time the Product was initially distributed from MOTOROLA SOLUTIONS.
10. Scratches or other cosmetic damage to Product surfaces that does not affect the operation of the Product.
11. Normal and customary wear and tear.

## VI. PATENT AND SOFTWARE PROVISIONS:

MOTOROLA SOLUTIONS will defend, at its own expense, any suit brought against the end user purchaser to the extent that it is based on a claim that the Product or parts infringe a United States patent, and MOTOROLA SOLUTIONS will pay those costs and damages finally awarded against the end user purchaser in any such suit, which are attributable to any such claim, but such defense and payments are conditioned on the following:

1. that MOTOROLA SOLUTIONS will be notified promptly in writing by such purchaser of any notice of such claim,
2. that MOTOROLA SOLUTIONS will have sole control of the defense of such suit and all negotiations for its settlement or compromise, and
3. should the Product or parts become, or in MOTOROLA SOLUTIONS' opinion be likely to become, the subject of a claim of infringement of a United States patent, that such purchaser will permit MOTOROLA SOLUTIONS, at its option and expense, either to procure for such purchaser the right to continue using the Product or parts or to replace or modify the same so that it becomes non-infringing or to grant such purchaser a credit for the Product or parts as depreciated and accept its return. The depreciation will be an equal amount per year over the lifetime of the Product or parts as established by MOTOROLA SOLUTIONS.

MOTOROLA SOLUTIONS will have no liability with respect to any claim of patent infringement, which is based upon the combination of the Product or parts furnished hereunder with software, apparatus or devices not furnished by MOTOROLA SOLUTIONS, nor will MOTOROLA SOLUTIONS have any liability for the use of ancillary equipment or software not furnished by MOTOROLA SOLUTIONS, which is attached to or used in connection with the Product. The foregoing states the entire liability of MOTOROLA SOLUTIONS with respect to infringement of patents by the Product or any parts thereof.

Laws in the United States and other countries preserve for MOTOROLA SOLUTIONS certain exclusive rights for copyrighted MOTOROLA SOLUTIONS software such as the exclusive rights to reproduce in copies and distribute copies of such MOTOROLA SOLUTIONS software. MOTOROLA SOLUTIONS software may

be used in only the Product in which the software was originally embodied and such software in such Product may not be replaced, copied, distributed, modified in any way, or used to produce any derivative thereof. No other use including, without limitation, alteration, modification, reproduction, distribution, or reverse engineering of such MOTOROLA SOLUTIONS software or exercise of rights in such MOTOROLA SOLUTIONS software is permitted. No license is granted by implication, estoppel or otherwise under MOTOROLA SOLUTIONS patent rights or copyrights.

## VII. GOVERNING LAW:

This Warranty is governed by the laws of the State of Illinois, U.S.A.

## VIII. For Australia Only

This provision applies to products and services supplied by Motorola Solutions to consumers within the meaning of the Australian Consumer Law. This warranty is given by Motorola Solutions Australia Pty Limited (ABN16 004 742 312) of Tally Ho Business Park, 10 Wesley Court, Burwood East, Victoria. Our goods come with guarantees that cannot be excluded under the Australia Consumer Law. For major failures with the service, you are entitled:

- To cancel your service contract with us: and
- To a refund for the unused portion, or to compensation for its reduced value.

You are entitled to choose a replacement or refund for a major failure with goods. If a failure with the goods or service does not amount to a major failure, you are entitled to have the failure rectified in a reasonable time. If this is not done, you are entitled to a refund for the goods, and to cancel the contract for the service and obtain a refund of any unused portion. You are also entitled to be compensated for any other reasonably foreseeable loss or damage from a failure in the goods or service. If you have any queries, please call Motorola Solutions Australia at 1800 457 439. You may also visit our website: [https://www.motorolasolutions.com/en\\_xa/support.html](https://www.motorolasolutions.com/en_xa/support.html) for current warranty terms.

## SERVICE

Proper repair and maintenance procedures will assure efficient operation and long life for this product. A Motorola Solutions maintenance agreement will provide expert service to keep this and all other communication equipment in perfect operating condition. A nationwide service organization is provided by Motorola Solutions to support maintenance services. Through its maintenance and installation program, Motorola Solutions makes available the finest service to those desiring reliable, continuous communications on a contract basis. For a contract service agreement, please contact your nearest Motorola Solutions service or sales representative, or an authorized Motorola Solutions dealer.

Express Service Plus (ESP) is an optional extended service coverage plan, which provides for the repair of this product for a period of three years from the date of shipment from the factory, or the date of delivery if purchased from an authorized Motorola Solutions two-way radio dealer. For more information about ESP, contact the Motorola Solutions Radio Support Center, 2204 Galvin Drive, Elgin, IL 60123, 1-800-227-6772.

## Chapter 1

# Read Me First

This User Guide covers the basic operation of the radio.

### Notations Used in This Manual

Notations such as **Warning**, **Caution**, and **Notice** are used throughout the text in this publication. These notations are used to emphasize that safety hazards exist, and the care that must be taken or observed.



**WARNING:** An operational procedure, practice, or condition, and so on, which can result in injury or death if not carefully observed.





**CAUTION:** An operational procedure, practice, or condition, and so on, which can result in damage to the equipment if not carefully observed.



**NOTE:** An operational procedure, practice, or condition, and so on, which is essential to emphasize.

The following special notations identify certain items.

Example	Description
<b>Home</b> button or 	Buttons and keys are shown in bold print or as an icon.
Phone	Menu entries are shown similar to the way that they appear on the display of the radio.
	This means “Press the right side of the 4-Way Navigation button.”

### What Your Dealer or System Administrator Can Tell You

Your dealer or system administrator can customize your radio to your specific needs. If the radio is to be operated in extreme temperatures (less than -30 °C or more than +60 °C), check with your system administrator for the correct radio settings.

You can consult your dealer or system administrator about the following:

- Is your radio programmed with any preset conventional channels?
- Which buttons have been programmed to access other features?
- What optional accessories suit your needs?



**NOTE:** Specifications vary for different radio models. For more information, contact your system administrator.

#### 1.1

## Software Version

All the features described in the following sections are supported by the software version **R33.00.00** or later. Contact your system administrator for more details of all the supported features.

## Chapter 2

# Radio Care

Proper radio usage and care ensure efficient operation and long-life of the product.



**CAUTION:** Use the radio according to the following recommendations and warnings.

- The cables connecting the rear of the radio can have live voltage on their pins. Do **not** remove or reconnect these cables. Only a qualified radio technician should perform this task. Service performed by unauthorized personnel can cause the radio to transmit an emergency alarm even if the unit is turned off.
- If your radio is locked up or the display shows `FAIL 01/09`, power cycle the radio. If this does not correct the condition, take the radio to a qualified radio technician for service.
- If radio operation is intermittent, check with other persons using the system for similar problems. Similar problems can indicate a system malfunction rather than a radio failure.
- If symptoms persist or if your unit exhibits other problems, contact a qualified radio technician.

### 2.1

## Cleaning the External Surface of the Radio

### Prerequisites:



**CAUTION:** Do **not** use solvents to clean your radio. Spirits can permanently damage the radio housing. Do **not** submerge the radio in detergent solution.

### Procedure:

1. Combine one teaspoon of mild dishwashing detergent to one gallon of water (0.5% solution) to clean the external surfaces of the radio.
2. Use a stiff, nonmetallic, short-bristled brush to apply the solution sparingly to remove any loose dirt from the radio.  
Ensure that excess detergent does not get entrapped near the connectors, controls, or crevices.
3. Dry the radio thoroughly with a soft, absorbent, lint-free cloth.
4. Ensure that no water remains entrapped near the connectors, cracks, or crevices.



Chapter 3

# Radio Overview

Radio overview explains the buttons, icons, and LED indications of your radio.

**Figure 1: E5 Control Head and Microphone**



**Table 2: E5 Control Head and Microphone Callouts**

Label	Name	Description
1	Volume Knob	Allows you to adjust the volume.
2	Power button	Allows you to turn the radio on or off.
3	LED Indicator	Provides operating status.
4	Accessory Port (Microphone)	Allows you to connect a microphone to your radio.
5	Dimmer button	Allows you to adjust the brightness, and toggle between day and night mode.
6	P Button	Programmable button of an assignable radio function.
7	Menu Select buttons	Allows you to access the corresponding menu.
8	4-Way Navigation buttons	Allows you to scroll and navigate through the menu hierarchy. At the Home screen, press the left or right navigation button to display the required menu items.
9	Home button	Allows you to access the Home screen.
10	Bluetooth Pairing Location Indicator <sup>1</sup>	Provides Bluetooth Pairing Location Indicator status.

<sup>1</sup> Depending on the version, your mobile radio could support either Bluetooth technology or Wireless Pair. For more information on all the supported features, contact your system administrator.

Label	Name	Description
11	Orange button	Programmable button of an assignable radio function. This button is usually programmed as the Emergency button.
12	Mode Knob	Allows you to scroll through the channel list.
13	Main Display	The main display screen of your control head.
14	Push-to-Talk (PTT) button	Allows you to execute voice operations.
15	Accessory No-Dot (Purple) button	Programmable button of an assignable radio function.
16	Accessory 1-Dot button	Programmable button of an assignable radio function.
17	Accessory 2-Dot button	Programmable button of an assignable radio function.
18	Keypad	Allows you to enter alphanumeric characters for dialing, contact entries, and text messages.
19	Navigation button (Microphone)	Allows you to scroll and navigate through the menu hierarchy.
20	Cancel button	Allows you to cancel the current operation and return to the previous screen.
21	Okay/Select Button	Allows you to select the option that appears on the screen.
22	Home button (Microphone)	Allows you to access the Home screen.
23	Data Feature button	Allows you to access the Text Messaging screen, or the Inbox menu.

### 3.1

## Programmable Radio Functions

Your system administrator can program the programmable buttons or switches as shortcuts to radio functions depending on the duration of a button press. Contact your system administrator to learn more about the radio functions assigned to the programmable buttons and switches of your radio.

**Table 3: Programmable Radio Functions**

Function	Description
Action Consolidation	Allows you to initiate a programmed sequence of Consolidated Actions.
Airhorn	Allows you to activate and deactivate the Airhorn Siren tone.
Aux Control (1-3)	Allows you to individually activate and deactivate radio Vehicular Interface Port (VIP) Outputs that are set to an <b>Aux Control</b> .
Bluetooth Audio Reroute	Allows you to cycle active speaker audio between a portable radio internal speaker or external (RSM/DRSM) speaker, and wireless speakers of a Bluetooth accessory.
Bluetooth Configuration	Provides you with a list of Bluetooth status or information, and Bluetooth options.
Bluetooth Discoverable On/Off	Allows you to activate and deactivate Bluetooth discoverable mode.

Function	Description
Bluetooth Headset PTT	Serves as the primary or additional PTT button for a Bluetooth wireless headset. This button-press allows you to key up the radio while using the Bluetooth headset microphone as the audio source.
Bluetooth Inquiry On/Off	Allows you to activate and deactivate Bluetooth Inquiry mode.
Bluetooth On/Off	Allows you to activate and deactivate the Bluetooth capabilities of the radio.
Call Alert	Allows you to transmit a Call Alert for Conventional Mode, and a Call Alert or Page for Trunking Mode.
Call Response	Allows you to respond to and hang up from a received Phone Call (Conventional or Trunking) or Private Call (Trunking only).
Channel Announcement	Allows you to hear the Voice Announcement audio file that is assigned to the current channel or mode of the radio.
Channel Search	Allows you to search for a channel or mode based on the programmed channel name, and directly switch to the found channel.
Channel Select	Allows you to enter the desired radio channel.
Contacts	Allows you to view or edit the contacts from the current channel of the radio.
Dim	To adjust the brightness of the display, press the button. To toggle between day and night mode, press and hold the button.
Direct External Radio	Allows you to directly activate and deactivate External Radio mode.
Direct Hi/Lo	Allows you to directly activate and deactivate a Siren broadcast that plays Hi or Lo Siren tones.
Direct Manual	Allows you to directly activate and deactivate a Siren broadcast that plays the RM-defined Manual Tone of the Siren option.
Direct Message	Allows you to transmit the Message member specified in the <b>Sts/Msg Index</b> codeplug field of the button.
Direct Mode	Allows you to switch to the channel or mode configured for this Top Function Programmable button.
Direct Status	Transmits the Status member specified in the <b>Sts/Msg Index</b> codeplug field of the button.
Direct Wail	Allows you to directly activate and deactivate a Siren broadcast that plays a Wail Siren tone.
Direct Yelp	Allows you to directly activate and deactivate a Siren broadcast that plays a Yelp Siren tone.
Digital Vehicular Repeater System (DVRS)	Allows you to switch between the DVRS modes.
DTMF Tone	Sends out DTMF code of the assigned DTMF value
Dynamic ID (Conventional Only)	Allows you to edit the ASTRO Individual ID or MDC Primary ID of the radio.
Dynamic Priority (Conventional Only)	Allows you to select the Dynamic Priority scan assignment.
Emergency	Allows you to enter and also exit Emergency Mode Operation.

Function	Description
Emergency Supervisor Clear	This button-press is selected for Side Middle Button or Accy 1-dot. Emergency Exit Control is set to <b>Supervisor</b> .
External Radio	Allows you to activate and deactivate External Radio Mode with a Siren button-press.
Front/Rear	Allows you to switch the focus of the radio between Control Heads, thus allowing one of two control heads to be active at one time.
Gunlock (1, 2, 3, or All)	These four separately programmed button-presses, Gunlock 1, Gunlock 2, Gunlock 3 and Gunlock All, allow you to unlock Gunlock 1, 2, or 3, or all Gunlocks simultaneously.
Hi/Lo	Allows you to select the Hi/Lo Siren tones.
Horn Lights	Allows you to turn the horn and lights external alarms on or off.
In Car Monitor	Allows you to toggle between the two In Car Monitor (ICM) modes, which are ICM All or ICM Selected.
Information (Info)	Allows you to retrieve and view basic radio information such as IP-related information, buttons or switches control mapping, and view or modify the Soft ID.
Intercom	Allows you to access the Intercom feature.
Internet Protocol Address (IP)	Allows you to retrieve and view on the radio display the current IP Address, device name, and status of the radio.
Location	Allows you to determine the current location (latitude, longitude, time, and date) and also the distance and bearing to another location.
Manual	Allows you to activate and deactivate the RM-defined Manual Tone of the Siren option.
Message	Allows you to select from the Message Alias List of the current channel or mode.
Modem On and Off	Allows you to activate and deactivate Modem capability.
Mode Select (MS01–MS13)	To change to the preset Mode Select zone and channel, press the button.  When the <b>Preconfigurable Preset Zone and Channel</b> field is enabled, to save the current zone and channel to one of the Mode Select menus, press and hold the preferred Mode Select menu.
Monitor	Allows you to hear most or even all carrier activity on the current channel of the radio.
Multiple Private Line (MPL)	Allows you to access to a listing of the available MPL Lists.
Nuisance Delete	Temporarily removes the channel from the current Active Scan when it continually generates unwanted carrier noise.
One Touch 1–16	Launches a specific feature with one single button-press.
Phone	Initiate Phone Mode while operating in Conventional or Trunking communications mode.
Priority Channel PTT	If your radio is operating in Scan Mode, and a Priority Member 1 Scan List Member is available in the Scan List of the current channel, pressing this button can cause the radio to key up on the Priority 1 Scan List Member channel. This operation allows transmission of

Function	Description
	voice communications. Otherwise, the radio blocks the transmission and plays the Talk Prohibit Tone.
Priority Dispatch	Allows you to call the dispatcher on a different talkgroup.
Public Address (PA)	Allows you to activate and deactivate the PA system, which routes microphone audio through an external speaker system.
Radio Profiles	Allows you to select one of the programmed Radio Profiles.
Radio Swap	To switch back and forth between two radios that are attached to the same control head in a Dual Radio configuration, press the button.  To allow the programmed Radio Alias of the selected radio to temporarily appear in the control head display, press and hold the button.
Recent Calls	Allows you to view the recent call history of your radio.
Rekey Request	Notifies the dispatcher that a new encryption key is needed.
Relay Pattern	Allows you to activate and deactivate a Relay Lightbar Pattern.
Remote Emergency	Activates the Remote Emergency feature for an authorized user to initiate the Emergency feature on a target radio without target user intervention.
Repeater Access Button (RAB) (Conventional Only)	Allows you to manually send a repeater access codeword.
Reprogram Request (Trunking Only)	Notifies the dispatcher that a new dynamic regrouping assignment is needed.
Request-To-Talk (RTT) (Conventional Only)	Notifies the dispatcher that you want to send a voice call.
Scan	To turn on or off the scan function, press the button.  To enable or edit the Scan List Programming, press and hold the button.
Secure Transmission Select	Allows you to securely toggle transmission on or off.
Select/Private Call	Allows you to transmit a Conventional Selective Call or Trunking Private Call.
Siren	Allows you to activate and deactivate the external Siren alert tones.
Site Display/Search (Trunking Only)	To display the current site ID and Received Signal Strength Indicator (RSSI) value, press the button.  To perform site search for Automatic Multiple Site Select (AMSS) or SmartZone operation, press and hold the button.
Site Lock/Unlock (Trunking Only)	To view the lock status of the current Trunking site, press the button.  To lock or unlock the site, press and hold the button.
Status (Trunking Only)	Allows you to select status from the Status Alias List of the current channel or mode.
Talkaround/Direct (Conventional Only)	Allows you to toggle between using a repeater or communicating directly with another radio.
Talkgroup (Conventional Only)	Allows you to switch from the preset talkgroup to another talkgroup from the current Talkgroup List of the Conventional Personality.

Function	Description
Text Messaging Service (TMS)	Allows you to access the <b>TMS</b> menu.
Third Party	Initiates functionality in compatible third-party accessories.
TMS Query	Brings you directly to the programmed Query Message entries of the TMS feature.
TMS Quick Text	Allows you to select predefined messages.
Transmit Low Power	Allows you to change the radio transmission power from low to high and back on a radio-wide basis.
User	Allows you to log on to the server with an identifiable user name.
Voice Mute	Allows you to toggle on and off Voice Mute functionality for In-Call User Alert-enabled channels.
Volume Down	Allows you to decrease the volume of the radio.
Volume Up	Allows you to increase the volume of the radio.
Wail	Allows you to select the Wail Siren tone.
Wi-Fi On/Off	Toggles Wi-Fi on or off.
Yelp	Allows you to select the Yelp Siren tones.
Zone Down	Allows you to scroll downward through the Zones in the radio.
Zone Up	Allows you to scroll upward through the Zones in the radio.

### 3.2

## Programmable Button Configurations for Gun Lock

This feature uses the programmable buttons of the radio to control up to three gun locks.

The available configurations are:

#### **Gun Lock 1**

Triggers first gun lock to open.

#### **Gun Lock 2**

Triggers second gun lock to open.

#### **Gun Lock 3**

Triggers third gun lock to open.

#### **All Gun Locks**

Triggers all gun locks to open concurrently but close in a sequence with a few seconds of difference in between.

Due to security purposes, neither text nor icon is displayed for this feature.

### 3.2.1

## Unlocking All Gun Locks

### Procedure:

Unlock all Gun Locks by using the following options:

Option	Actions
Unlocking all Gun Locks with relock timer	<ol style="list-style-type: none"> <li>To open the Gun Locks, press the programmed <b>Gun Lock</b> button.</li> <li>Place or remove your guns from the Gun Locks in the sequence from Gun Lock 1 to Gun Lock 3.</li> </ol> <p> <b>NOTE:</b> The locks close when the timer for each lock expires.</p>
Unlocking all Gun Locks without relock timer	<ol style="list-style-type: none"> <li>To open the Gun Locks, press and hold the programmed <b>Gun Lock</b> button.</li> <li>Place or remove the required guns from the Gun Locks.</li> <li>To close the Gun Locks, release the programmed <b>Gun Lock</b> button.</li> </ol>

### 3.3

## ViQi

ViQi is a virtual assistant that helps you manage your radio and perform information lookups using voice commands. This feature is purpose-built for public safety and is active when you press the assigned **ViQi** button on the radio, Remote Speaker Microphone (RSM), or compatible mobile microphone.

### ViQi Virtual Partner



ViQi Virtual Partner helps you to look up information such as license plate, driver's license, and Vehicle ID Number (VIN), and they respond with a result to your query.

**Table 4: ViQi Virtual Partner Queries**

The following table shows the queries supported by the ViQi Virtual Partner feature and their respective commands. Use the following commands followed by the supported query instructions to initiate ViQi Virtual Partner:

- "Look up..."
- "Check..."
- "Run a..."

Query	Examples
License plate	<p>"Run a <i>&lt;state&gt;</i> license plate <i>&lt;alphanumeric string&gt;</i>"</p> <p>"Check a <i>&lt;state&gt;</i> license plate."</p> <p>"Look up <i>&lt;state&gt;</i> license plate <i>&lt;alphanumeric string&gt;</i>"</p>

Query	Examples
Driver's license	“Run a <state> driver's license <alphanumeric string>” “Check the state of <state> driver's license <alphanumeric string>” “Look up <state> driver's license <alphanumeric string>”
Vehicle Identification Number	“Check Vehicle Identification Number <alphanumeric string>” “VIN check <alphanumeric string>” “Run a VIN.”  <b>NOTE:</b> You can use variations such as <vehicle identification number>, <VIN>, and <vehicle number>.
Own Location	“Where am I?” “Can I get my exact location?” “Am I still at the <location>?”  <b>NOTE:</b> ViQi will ask for more information to complete the query.
Target Location	“Where is <unit name>?” “Tell me where <unit name> is.”  <b>NOTE:</b> ViQi will ask for more information to complete the query.

### 3.3.1

## Using ViQi Virtual Partner

**Prerequisites:** To perform queries, you are required to log in to CommandCentral.

**Procedure:**

1. Press and hold the programmed **ViQi** button.
2. After you hear a tone, speak your command into the microphone.
3. Release the programmed **ViQi** button and wait for ViQi to respond.
4. Throughout your session, repeat [step 1](#) to [step 3](#) when responding to ViQi.



**NOTE:** You can say the following commands:

- To play the available results, say “Play results”.
- To request for more details, say “More details”.
- To complete the Virtual Partner session, say “Complete”.



## Chapter 4

# Getting Started

This section provides instructions to prepare your radio for use.

### 4.1

## Turning the Radio On or Off

### Turning the Radio On

#### Procedure:

To turn the radio on, press and hold the **Power** button.

#### Result:

The radio shows the following indications:

- The red, yellow, and green LEDs illuminate.
- The display shows the current zone and channel, codeplug alias, and menu items on the homescreen.
- The backlight turns on to the last selected dim level.



#### NOTE:

If `Fail ##/##` appears on the display, the radio is unable to function until the condition is corrected.

If `Error ##/##` appears, some non-critical data has been changed. If the display goes blank, or if the unit appears to be locked up, see [Radio Care](#) for more information.

If `Ch mismatch` appears, the Control Head is connected to an incompatible transceiver, or vice versa.

If your radio does not power up, contact your system administrator.

### Turning the Radio Off

#### Procedure:

To turn the radio off, press and hold the **Power** button.

When the radio is turned off in Dark Mode, the power up display brightness level can be set to minimum.

### 4.2

## Validating Compatibility During Power Up

During power-up, the radio validates and updates the software and hardware of your control heads. During validation, the display shows `Maintenance Mode Remote Device` and other maintenance statuses.

#### Procedure:

Perform one of the following actions:

- To reset when the display shows `Update done Please reset` upon completion, press the **Power** button.

- To reset when the display shows `Update failed Please reset` when it fails to update, press the **Power** button.

**Result:** If the updates are incomplete, the radio enters the Maintenance Mode. The display shows `Maintenance Mode Remote Device` and other maintenance statuses.



**NOTE:** If `SW incomplete` appears, use Flashport Recovery Tool to update the control heads before you turn on the radio again.

### 4.3

## Adjusting the Volume

### Procedure:

Perform one of the following actions:

- To increase the volume, rotate the **Volume Knob** clockwise.
- To decrease the volume, rotate the **Volume Knob** counterclockwise.

Chapter 5

# Home Screen Overview

Figure 2: Home Screen Display

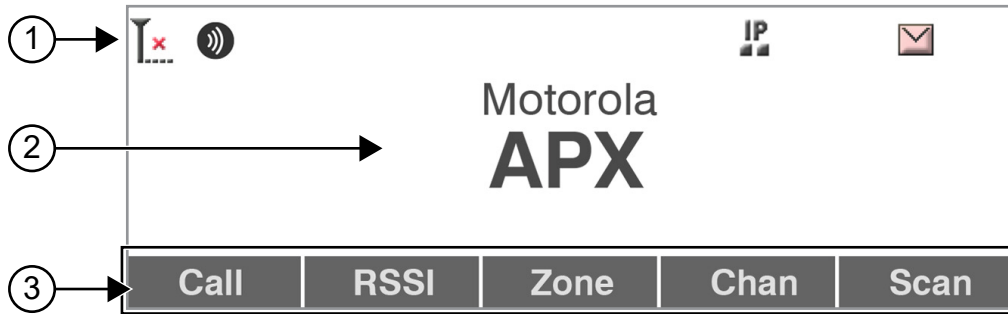

Table 5: Home Screen Overview Description

Number	Name	Description
1	Status Bar	Status icons appear in the status bar to provide device status and feature notifications.
2	Radio Control Widget	Displays the zone, channel, trunking status, and call state.
3	Menu Items	Displays the programmed menu items.

## 5.1

### Status Indicators













This section explains the status indicators of the radio.

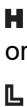











#### 5.1.1

### Status Icons

The liquid crystal display (LCD) of your radio shows the radio status, text entries, and menu entries. The following are the icons that appear on the display of the radio.

Icon	Description
	The radio is receiving a call or data.
	The radio is transmitting a call or data.
	The radio received an Individual Call.

Icon	Description
	The number of bars represents the received signal strength of the current site in trunking mode. The more stripes in the icon, the stronger the signal.
	The radio has roamed to and is registered to a foreign system.
	<p>Direct</p> <p><b>On</b> The radio is configured for direct radio-to-radio communication in conventional operation.</p> <p><b>Off</b> The radio is connected with other radios through a repeater.</p>
	The selected channel is being monitored in conventional operation.
	The In-Call User Alert feature is enabled. Voice muting of the affiliated trunking talkgroup or selected conventional channel is activated.
	<p>The radio is set at High power.</p> <p>The radio is set at Low power.</p>
	The radio is scanning a scan list.
	<p><b>Blinking dot</b> The radio detects activity on the designated Priority-One channel.</p> <p><b>Steady dot</b> The radio detects activity on the designated Priority-Two channel.</p>
	<p><b>On steady</b> The radio is in View mode</p> <p><b>Blinking</b> The radio is in Program mode.</p>
	The vote scan feature is enabled.
	<p><b>On</b> Secure operation.</p> <p><b>Off</b> Clear operation.</p> <p><b>Blinking</b> Receiving an encrypted voice call.</p>
	<p><b>On</b> The radio is operating in an Advanced Encryption Standard (AES) secure channel.</p> <p><b>Off</b> The AES operation is cleared.</p> <p><b>Blinking</b> The radio is receiving an AES-encrypted voice call.</p>
	<p><b>On</b> The Global Position System (GPS) feature is enabled, and the signal is available.</p>

Icon	Description
	<p><b>Blinking</b> The GPS feature is enabled, but no signal is available.</p>
IP	<p>User Login Indicator (IP Packet Data)</p> <p><b>On</b> The user is associated with the radio.</p> <p><b>Blinking</b> The device registration or user registration with the server failed due to an invalid username or pin.</p> <p><b>Inverted</b> The user is logged on to the secured IP packet data.</p>
	Data activity is present on the radio.
	The Bluetooth wireless technology is turned on and ready for connection.
	The Wireless-Pair device is on.
	The Wireless-Pair device is connected.
BB	<p><b>Steady</b> The broadband system is available and connected.</p> <p><b>Blinking</b> The Automatic Registration Service (ARS) user login failed while in broadband system.</p>
	The radio is receiving the broadband signal.
	The radio is transmitting the broadband signal.
	The radio is receiving and transmitting the broadband signal.
	The ARS user logged on successfully with the broadband system.
	The radio is receiving a broadband signal with the ARS user logged on.
	The radio is transmitting a broadband signal with the ARS user logged on.
	The radio is receiving and transmitting broadband signals with the ARS user logged on.
	Your radio is connected to a Wi-Fi® network. The number of bars represents the signal strength of the Wi-Fi network.









Icon	Description
	<p><b>On</b>                      The current channel is capable of supporting SmartConnect.</p> <p><b>Inverted</b>                      The current channel is currently connected through the SmartConnect feature.</p>

5.1.2

## Call Type Icons

Call icons appear on the radio display when you make or receive a call, or view selected call lists. The call icons indicate the call types associated with an alias or ID.

**Table 6: Call Type Icons**



Icon	Description
	A radio number.
	A radio number added to a Call List.
	A mobile number.
	A mobile number added to a Call List.
	A landline phone number.
	A landline phone number added to a Call List.
	An incoming call or data.
	An outgoing call or data.







5.1.3

## TMS Status Icons

Text Messaging Service (TMS) icons appear on the radio display when you send and receive text messages.

**Table 7: TMS Status Icons**

Icon	Description
	The inbox is full.
	The text message is sent.

Icon	Description
	The text message cannot be sent.
	The selected text message in the inbox is not read.
	The selected text message in the inbox is read.
	The message has normal priority without a request for reply.
	The Request Reply feature is toggled on before the message is sent.
	The Priority feature is toggled on before the message is sent.
	The message is urgent and requires a reply.
<b>3/6</b>	The index of the current message that you are viewing.

#### 5.1.4

### Text Entry Icons

Your radio uses icons to indicate the selected text entry mode.

**Table 8: Text Entry Modes**

Icon	Description
<b>HEX</b>	The text entry is in hexadecimal mode.
<b>123</b>	The text entry is in numeric mode.
<b>Ab↑</b>	The first character of the text entry is capitalized.
<b>Abc</b>	The text entry is in normal text mode.
<b>ABC</b>	The text entry is in uppercase mode.
<b>abc</b>	The text entry is in lowercase mode.
<b>xt9</b>	The text entry is in lowercase with predicted words shown at the bottom of the screen.
<b>Xt9</b>	The text entry is in mixed case and with predicted words shown at the bottom of the screen.
<b>XT9</b>	The text entry is in uppercase with predicted words shown at the bottom of the screen.

#### 5.1.5

### LED Indications

The LED indications represent the operational status of your radio.

**Table 9: LED Indications**

Indication	Status
Solid red	Radio is transmitting.
Double blinking red	Radio is transmitting an emergency alarm or call.
Rapid blinking red	Radio has failed the self-test upon powering up or encountered a fatal error.
Solid yellow	Radio is receiving in both trunking and conventional clear mode.  <b>NOTE:</b> The yellow LED illuminates only when the Busy LED feature is enabled through Customer Programming Software (CPS).
Blinking yellow	Radio is receiving a secured transmission.
Solid green	Radio is powering up or is on a non-priority channel while in the Scan List Programming mode.
Blinking green	Radio is receiving an individual or telephone call or is on a Priority-Two channel while in the Scan List Programming mode.
Rapid blinking green	Radio is on a Priority-One channel while in the Scan List Programming mode.

5.1.6

## Intelligent Lighting Indicators

This feature temporarily changes the keypad backlight color and the display background color (except the radio status and menu entries region) of the radio to help signal that a radio event has occurred.

Backlight and Bar Color	Notification	When
Red	Critical Alerts	The radio is out of range.
		The radio enters Failsoft mode.
		The radio is unable to establish a full connection with the system.
		The radio is unable to authenticate or register with the system.
Green	Call Alerts	The radio receives a private call.
		The radio receives a phone call.
		The radio receives a call alert.
		The radio receives a selective call.
		The radio enters Geofence.



5.1.7

## Channel Color Backlight

This feature allows you to identify your selected channel based on the color of the channel text and the menu options on the home screen. This color is also reflected on the control head buttons, knobs, and keypad microphone depending on the Customer Programming Software (CPS) configuration of your radio.

 **NOTE:** Check with your dealer or system administrator for more information.

**Figure 3: APX E5 Control Head Home Screen with Channel Color Backlight Feature**

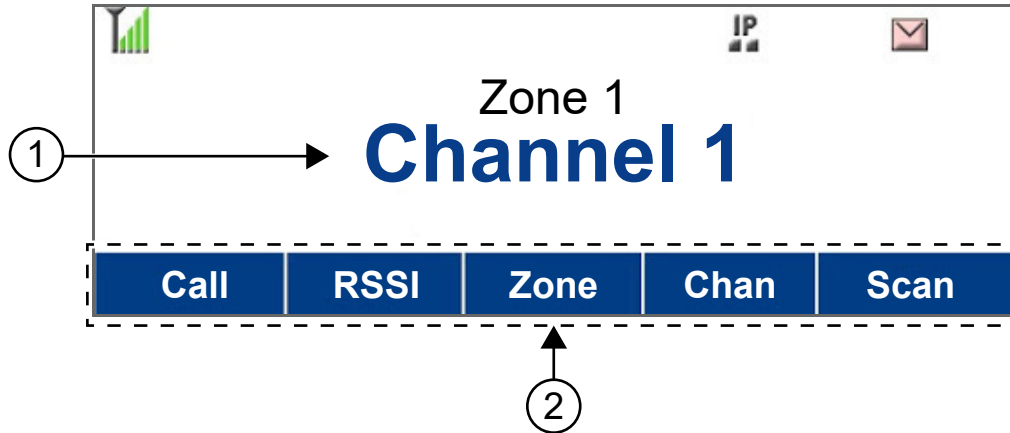

No.	Description
1	Channel text
2	Menu options

5.2

## Alert Tones

Your radio uses alert tones to inform you of the condition of your radio. The following table lists these tones and when they occur.

You Hear	Tone Name	When
Two high-pitched tones	Private Conversation	The radio receives a private call.
Four high-pitched tones every 5 s	Call Alert	The radio receives a call alert.
Single, high-pitched tone	Central Acknowledge	The central controller of the system receives the Call Alert, emergency alarm, reprogram request, or status/message transmission.
Four high-pitched tones	Mobile Unit Acknowledge	The intended unit receives a Call Alert page, or the intended dispatcher acknowledges the emergency alarm, reprogram request, or status/message transmission.

<b>You Hear</b>	<b>Tone Name</b>	<b>When</b>
<b>Sound similar to a telephone busy signal</b>	<b>System Busy</b>	If the <b>PTT</b> button is pressed, this tone indicates transmission fail. Release the PTT button. Wait for a callback.
<b>A series of two short, high-pitched tones</b>	<b>Automatic Call Back</b>	A channel is now available for your previously requested transmission.
	<b>Talk Permit (Optional)</b>	If the <b>PTT</b> button is pressed, this tone indicates the system is accepting your transmission.
<b>A series of low-pitched tones followed by a series of high-pitched tones</b>	<b>Scan Alert On</b>	The Scan feature is activated through the preprogrammed button.
<b>A series of high-pitched tones followed by a series of low-pitched tones</b>	<b>Scan Alert Off</b>	The Scan feature is deactivated through the preprogrammed button.
<b>Continuous, low-pitched tone</b>	<b>Talk-Prohibit</b>	If the <b>PTT</b> button is pressed, this tone indicates the system is out of service.
	<b>Smart PTT Inhibit</b>	If the <b>PTT</b> button is pressed with the Smart PTT feature enabled, this tone indicates the channel is busy.
	<b>Out-of-Range</b>	If the <b>PTT</b> button is pressed, this tone indicates the radio is not in the range of the trunked radio system.
	<b>Illegal Mode</b>	The radio enters a mode with no normal system traffic, or is attempting something not permissible. Examples include: forgetting to exit the telephone interconnect mode after a call ends (fleet and sub-fleet calls cannot be received), attempting to transmit on a receive-only conventional mode, attempting to select a dynamic mode with no dynamic ID assignment.
	<b>Auto Power Off</b>	The radio is turn off when no user actions occur during a preprogrammed length of time.
<b>Single, high-pitched tone every 9 s</b>	<b>Failsoft</b>	The trunked system central controller fails in an unmuted receiving condition. The radio reverts from trunked operation to a system similar to conventional radio repeater operation. Other system users can be heard sharing the channel.
<b>Brief low-pitched tone</b>	<b>Time-Out Timer Warning or Menu Inactive Exit</b>	The transmission of the radio will soon be disabled.
<b>Single, short, high-pitched tone</b>	<b>Valid Key</b>	If you press a valid key, enter a feature configuration state, or receive/transmit in the clear mode on secure models with TX Clear Alert Tones enabled.
<b>Single, low-pitched tone</b>	<b>Invalid Key</b>	If you try to make an invalid key press, or an emergency alarm, reprogram request, or status/message is not acknowledged.

## Chapter 6

# General Radio Operation

This chapter explains the general operations of your radio.

## 6.1

### Selecting Zones

A zone is a group of channels.

Option	Actions
Select a zone using the programmed <b>Zone (3-Position A/B/C)</b> switch	<p>Move the programmed <b>Zone (3-Position A/B/C)</b> switch to the position of the required zone.</p> <p> <b>NOTE:</b> If the zone number entered is un-programmed, the display Model 1.5 shows <code>INVALID</code>, and the display for Model 2.5 and Model 3.5 shows <code>Invalid entry</code>. Repeat this step.</p>
Select a zone using the <b>Zonemenu</b> item	
Select a zone using the <b>ZnUp</b> and <b>ZnDn</b> buttons	

#### Procedure:

1. Perform one of the following actions:
  - Move the programmed **Zone (3-Position A/B/C)** switch to the position of the required zone.
  - Press the **Zone** menu item and select the required zone.
  - Press the **Zone** menu item and enter the required zone number.
2. Press **Sel**.

## 6.2

### Selecting Channels

A channel is a group of radio characteristics, such as transmit or receive frequency pairs.

#### Procedure:

Select radio channels by using the following options.

Option	Actions
Selecting radio channels using the Mode Knob	Rotate the <b>Mode Knob</b> until the display shows the required channel.
Selecting radio channels from the menu	<ol style="list-style-type: none"> <li>a. Press the <b>Chan</b> menu item.</li> <li>b. Select the required channel and press <b>Sel</b>.</li> </ol>

Option	Actions
Selecting radio channels using the Channel Search button	<ol style="list-style-type: none"> <li>a. Press the <b>ChSr</b> menu item.</li> <li>b. Enter the channel name</li> <li>c. To initiate searching, press <b>ChSr</b>..</li> </ol>

### 6.3

## Mode Select Feature

The Mode Select feature allows you to save the current zone and channel on your radio to one of the Mode Select feature menus (MS01–MS05) on a programmable side button (MS01–MS13).

When programmed, pressing the button changes the transmission to the saved zone and channel. When the **Preconfigurable Preset Zone and Channel** field is enabled, pressing and holding the preferred Mode Select menu saves the current zone and channel to one of the Mode Select menus.



**NOTE:** Your radio must be programmed for you to use this feature.

#### 6.3.1

### Saving Zones and Channels

You can save frequently used zones and channels to softkeys and programmable buttons.

**Prerequisites:** Enable the **Preconfigurable Preset Zone and Channel** field.

**Procedure:**

1. Toggle from your current zone and channel to the required zone and channel.
2. Save zones and channels using the following options:

Option	Actions
Saving to a softkey	Press and hold any of the following softkeys: <ul style="list-style-type: none"> <li>• <b>MS1</b></li> <li>• <b>MS2</b></li> <li>• <b>MS3</b></li> <li>• <b>MS4</b></li> <li>• <b>MS5</b></li> </ul>
Saving to a button	Press and hold the button you want to program.

**Result:**

If the zone and channel is saved, a tone sounds.

If the **Preconfigurable Preset Zone and Channel** field is disabled, a negative tone sounds.



**NOTE:** Pressing the programmed button changes your current transmission to the zone and channel programmed in the button.

## 6.4

# Channel Change on Off-Hook

This feature determines the mode of the radio based on the Hub on or off-hook state of all the control heads.

Whenever the radio goes off-hook, it changes to a programmed zone channel assigned for off-hook state. While in off-hook state, you can change the mode manually. When you return the radio to on-hook state, it reverts to its previous channel zone before the radio goes off-hook.



**NOTE:** If the radio is operating on Tone Private Line (PL) Defeat or Suspend Scan operations during on-hook state, the radio is converted to work in a new channel. The Channel Change on Off-Hook feature is suspended until these conditions end.

During Dynamic Regroup channel selector lock state, Emergency, Transmit Inhibit, radio lock, or when an external key loader is attached to the radio, the Channel Change on Off-Hook feature is suspended.

### The Off-Hook State for APX Dual-Radio Setup

For Dual-Radio, the state of the Hub on the unselected radio is always considered as on-hook. If the Hub is in off-hook state, the selected radio changes the channel according to the configuration of the Customer Programming Software (CPS). The unselected radio does not trigger a channel change.

With Channel Change on Off-Hook enabled, when the Hub is placed off-hook and radio switch happens, the new selected radio moves to the target channel zone of its off-hook state. The new unselected radio reverts to the last user selected channel before the off-hook state.

### The Off-Hook State for Multiple Radios Setup

If multiple control heads are connected, the Hubs reflect the state of the active control heads. Any Hub placed off-hook by the active control heads makes the radio goes into off-hook state. The radio can be in on-hook state only when all Hubs are placed on-hook.



**NOTE:** Familiarize yourself with the functionality of this feature as removing the microphone can easily trigger a mode change on the radio.

## 6.5

# Selecting the Power Level

This feature enables you to select the power level at which your radio transmits. The radio always turns on to the default setting. Power level **Low** enables a shorter transmitting distance to conserve power. Power level **High** enables a longer transmitting distance.

**Prerequisites:** This feature must be programmed by a qualified radio technician.

### Procedure:

Press the **Pwr** menu item.

### Result:

If the power level is set to high, the display shows **High power** and the **Power Level High** icon.

If the power level is set to low, the display shows **Low power** and the **Power Level Low** icon.

## 6.6

# Selecting Radio Profile

This feature allows you to manually switch the visual and audio settings of the radio. The display, backlight, alert tones, and audio settings are defined according to the programmed radio settings of each radio profile.

### Procedure:

1. Press the **Prfl** menu item.

2. Select the required radio profile and press **Sel**.

**Result:** The radio returns to the Home screen. The profile name on the Home screen indicates the current selected radio profile.

## 6.7

# Controlling the Display Backlight

You can enable or disable the radio display backlight as needed, if poor light conditions make the display or keypad difficult to read.



**NOTE:** Your radio can be programmed to remove the lowest brightness (blackout) by a qualified radio technician. Contact your dealer or administrator for more information.

### Procedure:

Perform one of the following actions:

- To adjust the display brightness, press the **Dimmer** button.
- To toggle between day and night mode, press and hold the **Dimmer** button.

## 6.8

# Turning the Keypad Tones On or Off

### Procedure:

To turn keypad tones on or off, press the **Mute** menu item.

### Result:

If the keypad tones are turned on, the radio shows the following indications:

- A tone sounds.
- The display shows `Tones on`.

If the keypad tones are turned off, the display shows `Tones off`.

## 6.9

# Turning Voice Mute On or Off

This feature allows you to mute the voice transmission of the current zone and channel.

### Procedure:

To turn Voice Mute on or off, press the **VMut** menu item.

### Result:

If Voice Mute is successfully turned on, your radio shows the following indications:

- A tone sounds.
- The display shows `Voice mute on`.

If Voice Mute is successfully turned off, your radio shows the following indications:

- A tone sounds.
- The display shows `Voice mute off`.

6.10

## Using the Time-Out Timer

This feature turns off the transmitter of your radio. You cannot transmit longer than the preset timer setting. If you attempt to do so, the radio automatically stops your transmission, and you hear a talk-prohibit tone.



**NOTE:** The default timer is 60 seconds. Contact your system administrator to adjust the timer duration.

**Procedure:**

1. Press and hold the **PTT** button longer than the programmed time.

The radio shows the following indications:

- A tone sounds.
- The transmission is cut off.
- The LED extinguishes.

2. To reset the timer, release the **PTT** button.
3. To retransmit, press the **PTT** button.

The time-out timer restarts, and the red LED illuminates.

6.11

## Conventional Squelch Operation

This feature filters out unwanted calls with low signal strength or channels that have a higher than normal background noise.

### Analog Options

Tone Private Line, Digital Private-Line, and carrier squelch is available and programmed per channel.

Option	Result
Carrier squelch	You hear all traffic on a channel.
Tone Private Line or Digital Private-Line	The radio responds only to your messages.

### Digital Options

One or more of the following options can be programmed in your radio. For more information, contact your system administrator.

Option	Result
Digital Carrier-Operated Squelch	You hear all digital traffic.
Normal Squelch	You hear any digital traffic having the correct network access code.
Selective Switch	You hear any digital traffic having the correct network access code and correct talkgroup.

### 6.11.1

## Setting Conventional Squelch Operation

### Procedure:

1. Press the **Sql** menu item.
2. Perform one of the following actions:
  - To increase the squelch volume, press **+**.
  - To decrease the squelch volume, press **-**.
3. To return to the selected channel, press the **Home** button.

### 6.12

## Using the PL Defeat Feature

This feature allows you to override any coded squelch programmed to a channel. Your radio also unmutes any digital activity on a digital channel. When this feature is active, the Carrier Squelch status indicator is displayed.

### Procedure:

Remove the microphone from the hub to enable the PL Defeat feature.

One of the following indications occurs :

- Your radio plays the active transmission on the channel.
- If no activity is present, your radio is muted.

### 6.13

## Digital PTT ID Support

This feature allows you to see the radio ID (number) of the radio from whom you are currently receiving a transmission. The receiving radio and the dispatcher can view the ID, which consists of up to a maximum of eight characters.

The ID number of your radio is also automatically sent every time you press the **PTT** button. This feature is programmed per channel. For digital voice transmissions, the ID of your radio is sent continuously during the voice message.

### 6.14

## External Alarms (Horn and Lights)

Your service administrator can configure the control heads with external alarms (horn and lights) that are activated when a Call Alert Page, Private Call, or Phone Call is received. The radio is always turn on with the horn and lights feature enabled.



#### 6.14.1

## Using Non-Permanent Horn and Lights

### Procedure:

1. To enable the last selected alarm, press the **H/L** menu item.

The display shows the enabled alarms until the alarms are turned off.

2. To turn off the alarm, press the **H/L** menu item again.

#### 6.14.2

## Using Permanent Horn and Lights

If this feature is enabled, the alarm automatically turns on when the radio is turned on.

### Procedure:

1. To turn off the alarm, press the **H/L** menu item.
2. To enable the last selected alarm, press the **H/L** menu item again.

**Result:** The display shows the enabled alarm and then reverts to the selected mode.

#### 6.14.3

## Changing the Selected Alarms

### Procedure:

1. Press the **H/L** menu item until the display shows the required alarm.
2. Perform one of the following actions:
  - To turn on horn and lights, press **H+L**.
  - To turn on the lights, press **Lgts**.
  - To turn on the horn, press **Horn**.

### Result:

If you select **H+L**, the display shows `Horn/Lites on`.

If you select **Lgts**, the display shows `Lights on`.

If you select **Horn**, the display shows `Horn on`.



**NOTE:** An `Off` entry is shown at the softkey when one of the alarms is active. This entry selection deactivates the current active alarm.

#### 6.14.4

## Incoming Calls While Alarms are Turned On

When you receive a call with the Alarms turned on, the vehicle horn sounds for 4 seconds, or the car lights turn on for 60 seconds.

The display shows the type of call received (Call, Page, or Phone) and the selected mode name.

The time interval can be modified by a qualified radio technician.

### 6.14.5

## Turning Off Non-Rearmable External Alarms

### Procedure:

1. Perform one of the following actions:
  - To turn off external alarms and access that feature, press the **Call**, **Page**, or **Phon** menu item.
  - To turn off external alarms, press the **PTT** button or any control-head button.
2. To rearm the Horn and Lights feature, press the **H/L** menu item.

### 6.14.6

## Turning Off Rearmable External Alarms

### Procedure:

1. Perform one of the following actions:
  - To turn off external alarms and access that feature, press the **Call**, **Page**, or **Phon** menu item.
  - To turn off external alarms, press the **PTT** button or any control head button.
  - To turn off external alarms and exit the Horn and Lights feature, press the **H/L** menu item.

The external alarm is turned off and automatically rearmed so that when you exit the entry, the external alarm automatically turns on.

2. To rearm the Horn and Lights feature, press the **H/L** menu item.

### 6.15

## Universal Relay Controller

The Universal Relay Controller (URC) is a relay module that controls the patterns on the Light Bar operation.

The URC receives logic level input signals configured by programmable logic controller (PLC), process controllers, and indicators to switch on/off a series of output signals. The URC supports up to 25 customized patterns, each pattern is a combination of 10 relays in the URC.

The buttons or knobs that support URC are:

- Response selector
- Directional buttons
- Top/Bottom Programmable buttons
- P button
- Keypad buttons

URC also supports Action Consolidation feature to run the lightbar.

Contact a qualified radio technician for details on customizing different relay patterns using the Customer Programming Software.

## 6.16

# Low Voltage Threshold Warning

A specific external device is attached to the radio to monitor the automobile voltage. When the car battery goes lower than a predefined threshold, the external device asserts the Vehicular Interface Port (VIP) input to the radio.

When the VIP switch turns on, the VIP asserts input to the radio. The radio immediately initiates a 15 seconds low Voltage Prealert Timer. If the status of the VIP changed before this time-out timer ends, the radio returns to normal operation.

If the status of the VIP remains unchanged when the time-out timer ends, the display shows `Low Battery` and a tone sounds. A high-pitched tone sounds immediately after the **PTT** button is released.



**NOTE:** If the mobile radio is not connected to a Control Head, the bricks can only alert the user with battery alert tone and the transmit chirp.

## Chapter 7

# Trunking System Controls

This chapter explains the trunking system control features in your radio.

## 7.1

### Operating in Failsoft System

The failsoft system ensures continuous radio communication during a trunked system failure. If the trunking system fails, your radio automatically switches to the failsoft channel. In a failsoft operation, your radio transmits and receives in conventional operation on a predetermined frequency. When the trunking system returns to normal operation, your radio automatically leaves failsoft operation and returns to trunked operation.

#### Procedure:

1. To change to a different repeater frequency, rotate the **Mode Knob**.
2. To talk, press and hold the **PTT** button.
3. To listen, release the **PTT** button.

## 7.2

### Imbalanced Coverage

Imbalanced coverage occurs when the radio is able to receive the control channel but is unable to transmit back to the system. The radio generates a periodic tone and displays **No Comms**.

## 7.3

### Out-of-Range Radio

Your radio can no longer lock onto a control channel when out-of-range from the system.

When out-of-range, your radio shows the following indications:

- A tone sounds.
- The display shows the currently selected zone or channel combination, and out-of-range notification.

Your radio remains in this out-of-range condition until it locks onto a control channel or failsoft channel, or if it is turned off.

## 7.4

### SmartZone

The SmartZone™ feature extends communications beyond the reach of a single-trunked site (antenna location) when operating in a SmartZone system. SmartZone units provide expanded wide-area coverage.

SmartZone automatically switches the radio to a different site when the current site signal becomes unacceptable. This usually happens when the vehicle in which the radio is located is driven out of the range of one site, and into the range of another.

Under normal conditions, a SmartZone-enabled radio functions invisibly to the operator. However, the operator does have some manual controls on the Control Head—the **RSSI** menu entry. This button can be used to check, or change, the SmartZone operation.

## 7.5

# Site Trunking Feature

If the Zone Controller loses communication with any site, that site reverts to site trunking. When this occurs, you can communicate only with the radios within your trunking site.

The display shows the currently selected zone or channel, and the site trunking message.

## 7.6

# Site Search

When searching for a site, your radio is inoperable. In the site search mode, your radio scans for trunked control channels but has yet to connect to the trunking system or reach other trunking states. Other trunking states are such as Out of Range and Imbalanced Coverage.

The **Searching site** indicator alerts you that your radio is attempting to search for a valid trunked control channel.

## 7.7

# Locking or Unlocking Sites

This feature allows your radio to lock onto a specific site and inhibits roaming among wide-area talkgroup sites.

### Procedure:

1. Press the **Site** menu item.
2. Perform one of the following actions:
  - a. To lock a site, press **Lock**.
  - b. To unlock a site, press **Unlk**.

**Result:** The radio saves the new site lock state and returns to the Home screen.

## 7.8

# Viewing the Current Site

### Procedure:

1. Perform one of the following actions:
  - Press the programmed **Site Search** button.
  - Press the **RSSI** menu item.
2. Press the programmed **Site Displ/Srch** button.

**Result:** The display shows the name of the current site and corresponding received RSSI.

## 7.9

# Changing the Current Site

### Procedure:

Perform one of the following actions:

- Press and hold the programmed **Site Search** button.
- Press and hold the **RSSI** menu item.

### Result:

When the radio finds a new site, the radio returns to the Home screen.

## 7.10

# Trunked Announcement

This feature allows you to make announcements to the entire user group, monitor talkgroup calls, and other announcements.

Announcement calls are handled in two different ways, ruthless and non-ruthless preemption.

### Ruthless Preemption

When a ruthless preemption announcement call is initiated, the requesting radio begins transmitting immediately. All associated talkgroup calls taking place on other channels are immediately halted, and the radios are steered to the announcement call.

Transmitting radios continue to transmit until the **PTT** button is released, and unmute for the announcement call.

### Non-Ruthless Preemption

When a non-ruthless preemption announcement is initiated, the initiating unit receives a telephone-type busy tone. A callback will follow when all associated talkgroup conversations end.

## 7.10.1

# Initiating Announcements

### Procedure:

1. Turn the **Mode Knob** to locate the announcement-group mode.
2. To initiate announcements, press the **PTT** button.

## Chapter 8

# Types of Radio Calls

Your radio can make a Talkgroup, Private, Selective, and Telephone call in conventional and/or trunking mode.

Call Type	Conventional Mode	Trunking Mode	SmartConnect
<b>Talkgroup Call</b> This feature is a point-to-multipoint call operation. Your radio must be configured as a member of the talkgroup for you to communicate within the talkgroup.	✓	✓	✓
<b>Private Call</b> This feature is a call from one individual radio to another.	✗	✓	✗
<b>Selective Call</b> This feature is a call from an individual radio to another individual radio with privacy.	✓	✗	✗
<b>Telephone Call</b> This feature allows you to receive calls similar to standard phone calls from a landline phone.	✓	✓	✗

### 8.1

## Making Calls

### Procedure:

Make calls by using the following options:

Option	Actions
Talkgroup Call	<ol style="list-style-type: none"> <li>a. Select a talkgroup by performing one of the following actions:                             <ul style="list-style-type: none"> <li>• Press the <b>Tgrp</b> menu item and press <b>Sel</b>. The display shows the last selected talkgroup.</li> <li>• Rotate the <b>Mode Knob</b> to the channel with the required talkgroup.</li> </ul> </li> <li>b. To call, press the <b>PTT</b> button.</li> <li>c. Wait for the Talk Permit Tone. Then, press and hold the <b>PTT</b> button while speaking into the microphone.</li> <li>d. To listen, release the <b>PTT</b> button.</li> </ol>

Option	Actions
Private Call	<p><b>a.</b> Press the <b>Call</b> menu item.</p> <p><b>b.</b> To select the required ID, perform one of the following actions:</p> <ul style="list-style-type: none"> <li>● Press <b>Cnts</b> and select the required ID.</li> <li>● Press <b>List</b> to go to the first number of the call list.</li> <li>● Scroll to the required ID.</li> <li>● Enter the required ID with the keypad.</li> </ul> <p><b>c.</b> To call, press the <b>PTT</b> button.</p> <p><b>d.</b> Press and hold the <b>PTT</b> button while speaking into the microphone.</p> <p><b>e.</b> To listen, release the <b>PTT</b> button.</p> <p><b>f.</b> To return to the Home Screen, press the <b>Home</b> button.</p>
Selective Call	<p><b>a.</b> Press the <b>Call</b> menu item.</p> <p><b>b.</b> To select the required ID, perform one of the following actions:</p> <ul style="list-style-type: none"> <li>● Press <b>Cnts</b> and select the required ID.</li> <li>● Scroll to the required ID.</li> <li>● Enter the required ID with the keypad.</li> </ul> <p><b>c.</b> To call, press and hold the <b>PTT</b> button.</p> <p><b>d.</b> Speak into the microphone.</p> <p><b>e.</b> To listen, release the <b>PTT</b> button.</p> <p><b>f.</b> To return to the Home Screen, press the <b>Home</b> button.</p> <p> <b>NOTE:</b>        If you do not press the <b>Home</b> button to hang up, your radio remains in Selective Call state with the other unit. You miss all subfleet traffic and incoming phone calls.        Your radio must be programmed for you to use this feature.</p>
Telephone Call	<p><b>a.</b> Press the <b>Phon</b> menu item.</p> <p><b>b.</b> To select the required ID, perform one of the following actions:</p> <ul style="list-style-type: none"> <li>● Press <b>Cnts</b> and select the required ID.</li> <li>● Press <b>List</b> to go to the first number of the call list.</li> <li>● Scroll to the required phone number.</li> <li>● Enter the required phone number with the keypad.</li> </ul> <p><b>c.</b> To dial the phone number, press the <b>PTT</b> button.</p> <p><b>d.</b> When your call is answered, speak into the microphone while pressing and holding the <b>PTT</b> button.</p> <p><b>e.</b> To listen, release the <b>PTT</b> button.</p> <p><b>f.</b> To return to the Home Screen, press the <b>Home</b> button.</p>





8.2

# Receiving Calls

**Procedure:**

Receive calls by using the following options.

Option	Actions
Talkgroup Call	<p>When you receive a Talkgroup Call, your radio shows the following indications:</p> <ul style="list-style-type: none"> <li>• For Conventional system, the yellow LED illuminates. The display shows the talkgroup ID or alias, and the caller ID or alias.</li> <li>• For Trunking system, the display shows the caller ID or alias.</li> </ul> <ol style="list-style-type: none"> <li>a. To respond, press the <b>PTT</b> button.</li> <li>b. To listen, release the <b>PTT</b> button.</li> </ol>
Private Call	<p>When you receive a Private Call, your radio plays two alert tones, and the green LED blinks.</p> <ol style="list-style-type: none"> <li>a. Press <b>Resp</b> in 20 seconds after the call indicators begin.</li> <li>b. Speak into the microphone while pressing and holding the <b>PTT</b> button.</li> <li>c. To listen, release the <b>PTT</b> button.</li> <li>d. To end the call and return to the Home Screen, press the <b>Home</b> button.</li> </ol> <p> <b>NOTE:</b> If you press the <b>PTT</b> button before pressing <b>Resp</b>, your conversation is broadcast to all members of the talkgroup. If 20 seconds pass before you press <b>Resp</b>, you are not responding privately to the call. Instead, you initiate a Private Call.</p>

Option	Actions
Selective Call	<p>When you receive a Selective Call, your radio shows the following indications:</p> <ul style="list-style-type: none"> <li>• Two alert tones sound.</li> <li>• The yellow LED illuminates and the green LED blinks.</li> <li>• The display shows <code>Call received</code> and the home screen alternately.</li> <li>• The <b>Call Received</b> icon blinks.</li> <li>• The speaker unmutes.</li> </ul> <p><b>a.</b> Speak into the microphone while pressing and holding the <b>PTT</b> button.</p> <p><b>b.</b> To listen, release the <b>PTT</b> button.</p> <p> <b>NOTE:</b>        Your conversation is no longer private and is broadcasted to all members of the talkgroup if one of the following conditions occurs:</p> <ul style="list-style-type: none"> <li>• You press the <b>PTT</b> button before <b>Call</b>.</li> <li>• You press <b>Call</b> after 20 seconds from the call indicators. Instead, you initiate a Selective Call.</li> </ul>
Telephone Call	<p>When you receive a Telephone Call, your radio shows the following indications:</p> <ul style="list-style-type: none"> <li>• A telephone-type ringing sounds.</li> <li>• The green LED blinks.</li> <li>• The backlight of the screen turns green.</li> <li>• The display shows <code>Phone Call</code> and the <b>Call Received</b> icon blinks.</li> </ul> <p><b>a.</b> Press <b>Resp</b>.</p> <p><b>b.</b> Speak into the microphone while pressing and holding the <b>PTT</b> button.</p> <p><b>c.</b> To listen, release the <b>PTT</b> button.</p> <p><b>d.</b> To end the call and return to the Home Screen, press the <b>Home</b> button or <b>Exit</b>.</p>

### 8.3

## Making Priority Dispatch Calls

The Priority Dispatch feature allows you to call the dispatcher on a different talkgroup when a talkgroup is congested. This talkgroup is called the Priority Talkgroup. Each trunking talkgroup can have an assigned Priority Talkgroup. Priority Dispatch is not available in Emergency operations. The Scan feature is suspended when Priority Dispatch is initiated.

**Prerequisites:** The dispatch console that supports this feature must be programmed to use this feature. For more information, contact your system administrator.

**Procedure:**

1. Press the programmed **Priority Dispatch** button.

A tone sounds, and the radio enters Priority Dispatch mode. The radio exits this mode when the Priority Dispatch Time Out Timer expires.

2. Before the Priority Dispatch Time Out Timer expires, press and hold the **PTT** button to transmit.

The display shows the Priority Talkgroup alias.

3. To listen, release the **PTT** button.

The radio exits Priority Dispatch mode, return to its original talkgroup, and displays the home channel alias.

## Chapter 9

# Emergency Operation

The Emergency feature is used to indicate a critical situation. An emergency signal overrides any other communication over the selected channel.

Your radio supports the following Emergency modes:

- Emergency Alarm
- Emergency Call
- Emergency Alarm with Emergency Call
- Silent Emergency<sup>2</sup> Alarm

Only one of the Emergency modes can be assigned to the **Emergency** button or the **Emergency** footswitch.

Your radio is also programmed to operate in one of the following conditions:

### Tactical/Non-Revert

The radio sends an emergency alarm and/or makes an emergency call on the current channel.

### Non-Tactical/Revert for Conventional System

The radio reverts to the programmed emergency channel to send an alarm and/or make an emergency call.

For more information, contact your system administrator.

## 9.1

# Special Considerations for Emergency Operation

The following scenarios apply during Emergency operation:

**Table 10: Emergency Operation Scenarios**

Scenario	Outcome
If you press the <b>Emergency</b> button while in a channel that has no Emergency capability,	a tone sounds.
If you change to a channel or mode with no Emergency capability while in Emergency operation,	your radio shows the following indications: <ul style="list-style-type: none"><li>• A tone sounds until you select a valid Emergency channel or mode, or until you disable the Emergency operation.</li><li>• The display shows NO EMERGENCY.</li><li>• The display shows NO EMERGENCY</li></ul>
If you change to a channel or mode with Emergency capability while in Emergency operation,	the Emergency Alarm and/or Emergency Call continues on the new channel or mode.
If the radio is out-of-range of the system or the emergency alarm is not acknowledged,	your radio shows the following indications:

<sup>2</sup> This feature allows you to send an Emergency Alarm to the system without triggering any audio or visual indicators.

Scenario	Outcome
	<ul style="list-style-type: none"><li>• A tone sounds.</li><li>• The display shows <code>No acknowledge</code>.</li></ul>

## 9.2

# Sending Emergency Alarms

This feature allows you to send a data transmission, which identifies the radio sending the emergency, to the dispatcher.

### Procedure:

1. Press the programmed **Emergency** button.
2. To return to normal operation, press and hold the **Emergency** button or the **PTT** button.

### Result:

Your radio shows the following indications:

- A tone sounds.
- The display shows `Emergency` and home display alternately.
- When you receive acknowledgment from the dispatcher, the display shows `Ack received`.



**NOTE:** For trunking system, a tone sounds to indicate that the alarm has been received by the trunked system central controller.

## 9.3

# Sending Emergency Calls (Trunking Only)

This feature gives your radio priority access to a talkgroup.

### Procedure:

1. Press the programmed **Emergency** button.

Your radio shows the following indications:

- A tone sounds.
  - The red LED blinks.
  - The display shows `Emergency` on the current zone and channel.
2. Speak into the microphone while pressing and holding the **PTT** button.
  3. To end the transmission and wait for a response from the dispatcher, release the **PTT** button.
  4. To exit Emergency Call, press and hold the programmed **Emergency** button.

## 9.4

# Sending Emergency Alarms with Emergency Calls

This feature gives your radio priority access on a channel for conventional system, and to a talkgroup for trunking system.

If your radio has both emergency call and alarm features enabled, after the alarm is acknowledged, your radio automatically proceeds to the call mode.

**Procedure:**

1. Press the programmed **Emergency** button.

Your radio shows the following indications:

- A tone sounds.
- The red LED blinks.
- The display shows *Emergency*.



**NOTE:** For trunking system, a tone sounds to indicate that the trunked system central controller receives the alarm.

When you receive acknowledgment from the dispatcher, your radio shows the following indications:

- A tones sound.
- The display shows *Ack received*.

2. Speak into the microphone while pressing and holding the **PTT** button.
3. To end the transmission and wait for a response from the dispatcher, release the **PTT** button.
4. To exit Emergency Call, press and hold the programmed **Emergency** button.

Turning off the radio also cancels the emergency state.

## 9.5

# Sending Emergency Calls with Hot Mic (Trunking Only)

Hot mic is an activated microphone state. When sending emergency calls with hot mic, you can communicate with a group of radios without pressing the **PTT** button. The hot mic applies to the first voice transmission from your radio during the Emergency call. For subsequent transmissions in the same Emergency call, you must press the **PTT** button.

When indirect PTT such as Hot Mic is activated, the audio transmission can be configured in Customer Programming Software (CPS) to route the audio to the radio internal microphone, wired RSM microphone, or Bluetooth wireless microphone.

**Procedure:**

1. Press the programmed **Emergency** button.
2. Speak into the microphone without pressing the **PTT** button.  
The microphone remains active until the hot mic timer expires.
3. To exit Emergency Call, press and hold the programmed **Emergency** button.

## 9.6

# Sending Emergency Alarms and Calls with Hot Mic

This feature allows you to send an Emergency Alarm and Call with hot mic to a group of radios. Your radio must be programmed for this type of operation. When indirect Push-To-Talk (PTT) such as Hot Mic is activated, the audio transmission can be configured in Customer Programming Software (CPS) to route the

audio to the radio internal microphone, wired Remote Speaker Microphone (RSM) microphone, or Bluetooth wireless microphone.

**Procedure:**

1. Press the programmed **Emergency** button.
2. Speak into the microphone without pressing the **PTT** button.
3. To exit Emergency Call, press and hold the programmed **Emergency** button.  
Turning off the radio also cancels the emergency state.

**Result:**

Your radio shows the following indications:

- A tone sounds.
- The red LED blinks.
- The display shows *Emergency* on the current zone and channel.

The radio exits Emergency Alarm and enters the Emergency Call state when one of the following scenarios occurs:

- You receive the dispatcher acknowledgment. The display shows *Ack received*.
- You have no acknowledgment. The display shows *No acknowledge*.

9.7

## Exiting Emergency Operation

If an Emergency operation is triggered on your radio, the dispatch console, or radios configured as Supervisor can exit the Emergency operation. Radios configured as Supervisor can cancel emergency mode of other radios. The dispatch console must be programmed to use this feature. For more information, contact your system administrator.

**Procedure:**

- To exit the emergency operation, press and hold the programmed **Emergency** button.
- To exit the emergency operation as supervisor (Trunking only), use one of the following options:

Option	Actions
Exiting Emergency operation initiated by other radios	<ul style="list-style-type: none"><li>○ Press and hold the <b>Accessory No-Dot (Purple)</b> button and press the programmed <b>Emergency</b> button.</li></ul>

Option	Actions
Exiting Emergency operation initiated by the Supervisor	Perform one of the following actions: <ul style="list-style-type: none"><li>○ Press and hold the programmed <b>Emergency</b> button.</li><li>○ Press and hold the <b>Accessory No-Dot (Purple)</b> button, and press the <b>Emergency</b> button.</li><li>○ Wait for the console to clear the Emergency.</li></ul>



**NOTE:** Your radio supports the following button combinations:

- Radio **Accessory No-Dot (Purple)** button and **Emergency** button.
- Radio **Accessory No-Dot (Purple)** button and accessory **Orange** button.
- Accessory **1-Dot** button and radio **Emergency** button.
- Accessory **1-Dot** button and accessory **Orange** button.

## 9.8

# Remote Emergency

The Remote Emergency feature allows you to remotely launch the emergency feature on a target radio.

You can send the Remote Emergency request to radios from recently transmitted or received calls that are stored. The latest Recent Call List refreshes automatically on your radio.

### 9.8.1

## Sending Remote Emergency to Specific Users

#### Procedure:

1. Press the programmed **Remote Emergency** button.
2. Select the required user of the target radio.
3. To send Remote Emergency, press the **PTT** button or press **Send**.

#### Result:

If the ID of the target radio is valid, your radio displays sending notification and saves the ID as the last Remote Emergency ID.

If the ID of the target radio is invalid, your radio displays an invalid ID notification.

If your radio is in one of the following states, your radio plays a tone.

- Receive-only Channel
- Transmit Inhibit
- Out of Range
- Imbalance Coverage

If your radio receives acknowledgment, your radio displays a positive notification.

If your radio does not receive acknowledgment from the target radio, your radio displays a negative notification.



### 9.8.2

## Sending Remote Emergency by Entering the User ID

### Procedure:

1. Press the programmed **Remote Emergency** button.
2. Press any digit key.
3. Enter the number of the user ID.
4. To send Remote Emergency, press the **PTT** button or press **Send**.

### Result:

If the ID of the target radio is valid, your radio displays sending notification and saves the ID as the last Remote Emergency ID.

If the ID of the target radio is invalid, your radio displays an invalid ID notification.

If your radio is in one of the following states, your radio plays a tone.

- Receive-only Channel
- Transmit Inhibit
- Out of Range
- Imbalance Coverage

If your radio receives acknowledgment, your radio displays a positive notification.

If your radio does not receive acknowledgment from the target radio, your radio displays a negative notification.

### 9.8.3

## Manually Refreshing the Remote Emergency List

### Procedure:

1. Press the programmed **Remote Emergency** button.
2. To refresh the remote emergency list, press **Rfsh**.

**Result:** Your radio displays `List refreshed` followed by the updated remote emergency list.

### 9.8.4

## Receiving Remote Emergency

The remote emergency is launched only if emergency is enabled on your radio. The receiving radio displays `Emergency`.

### Procedure:

To exit the emergency operation, press and hold the programmed **Emergency** button.

## 9.9

## Impact Detection

This feature activates Emergency mode when your radio detects an impact or orientation changes on the vehicle in the event of a vehicle crash or rollover. Your radio automatically activates Impact Detected condition when the impact event meets or exceeds a predefined threshold.

Your radio must stay in this condition for a programmed amount of time before the Emergency Alarm or Call is activated. This feature sends out the location-based information if Global Positioning System (GPS) is enabled.

Your radio indicates hardware failure or malfunction by alternatively displaying `Impact HW` and `Error` along with a tone. Pressing any button of the radio besides the programmed button for volume and backlighting functionality, or accessory stops the error message and sound.

The following scenarios affect the Emergency feature activation:

- Pressing a programmed `Emergency` button cancels the Impact Detection sequence and enters the Emergency mode.
- Pressing the **PTT** button does not suspend the Impact Detection sequence.
- Pressing the **PTT** button, the **Clr** menu button, or the programmed **Clear** button when your radio displays the Impact Detected display alert, exits the Impact Detected condition.

### 9.9.1

## Impact Detected Condition

When your radio detects an impact on the vehicle that meets or exceeds the predefined threshold, your radio shows the following indications:

- A tone sounds.
- The display shows `IMPACT`.
- Post-Alert timer begins.

When the Post-Alert timer expires, your radio enters Emergency mode, and the display shows `EMERGENCY`.



**NOTE:** If the radio is programmed with Silent Emergency, the radio inhibits the alert tone and visual alert associated with the emergency feature. If the radio is programmed in Surveillance Mode, the radio inhibits all tones and lights on the radio.

### 9.9.2

## Exiting Impact Detected Condition

#### Procedure:

Perform one of the following actions:

- Press the programmed **Clear** button.
- Press **Clr**.

### 9.10

## Sending Evacuation Tones

#### Procedure:

1. Press and hold the **PTT** button on the radio keypad mic.
2. Press the **Orange** button.

#### Result:

A tone sounds when the **Orange** button is released. The tone sounds in all radios in the talkgroup until the **PTT** button is released.



**NOTE:** The radio does not transmit an evacuation tone if the radio is in secure mode.

## Chapter 10

# Ignition Switch Options

The Ignition Switch Options feature is configured in the Customer Programming Software (CPS). The feature determines the functionality of the radio based on the ignition state of the vehicle.

The following options are available with the Ignition Switch Options:

### Blank

This option allows you to turn the radio on or off through the **Power** button regardless of the ignition state.

### Transmit Inhibit

This option allows you to turn the radio on or off through the **Power** button regardless of the ignition state. If ignition is not present, all transmissions including trunking systems are inhibited.

### PTT Transmit Inhibit

This option allows you to turn the radio on or off through the **Power** button regardless of the ignition state. If ignition is not present, all **PTT** button transmissions are inhibited. However, the radio is able to affiliate with the trunking systems.

### Required

This option allows you to turn the radio on if ignition is present. The radio turns off through the **Power** button press or when ignition is lost.

- If your radio turns off while the ignition is removed, your radio will automatically turn on when the ignition is present.
- If your radio is configured with Auto Power Off Timer, your radio will automatically turn off after being inactive.

### Soft Power Off

This option allows you to turn the radio on through the **Power** button or when ignition is detected.

- If the **Power** button is pressed or the ignition is removed, your radio turns off.
- If your radio is configured with Auto Power Off Timer, your radio will automatically turn off after being inactive.

### Ignition Only Power Up

In this option, the radio turns on when ignition is detected and turns off when ignition is removed.

- Your radio will not turn on or off with the **Power** button press.
- If your radio is configured with Auto Power Off Timer, your radio will automatically turn off after being inactive.



#### NOTE:

If the radio is turned on with an Emergency Power Up footswitch-press, you are required to press the **Power** button to turn off the radio even if ignition is not present.

If the radio is previously turned off due to the Auto Power Off Timer, you are required to press the **Power** button to turn on the radio even if ignition is present.

## 10.1

# Using Emergency Power Up

Emergency Power Up allows you to turn on the radio and automatically transmit an emergency mode on personalities with emergency enabled. This feature is not available if the Ignition Switch option is set to either Tx Inhibit or PTT Tx Inhibit.

**Procedure:**

To turn on the radio and launch Emergency, press the footswitch.

**Result:** Your radio shows the following indications:

- A tone sounds.
- The display shows *Emergency*.

## Chapter 11

# Secure Operations

Secure radio operation provides the highest commercially available level of voice security on both trunked and conventional channels.

By default, the radio automatically enters the encrypted environment without having to manually select or clear the secure transmission.

This extended feature can only be enabled through Customer Programming Software (CPS) configuration.

## 11.1

# Enabling Secure Transmissions

**Prerequisites:** Check if the secure feature is enabled or disabled.

### Procedure:

1. If secure feature is disabled, enable the secure feature by pressing the **Sec** menu item.

The display shows , and the current key.

2. Monitor the mode and ensure that it is not in use.
3. To transmit, press the **PTT** button.

### Result:

If the selected channel is programmed for clear-only operation, your radio shows the following indications:

- A tone sounds.
- The display shows `Clear TX`.



### NOTE:

The radio does not transmit until you disable the secure mode. The radio can be configured to ignore clear voice or unsecured transmission when the radio is in secured transmission. For more information, contact your system administrator.

## 11.2

# Encryption

This chapter explains the encryption feature on your radio.

### 11.2.1

## Multikey Feature

This feature allows your radio to be equipped with different encryption keys and supports the DES-OFB algorithm.

There are two types of encryption keys:

### Conventional Multikey

The encryption keys are strapped on a one-per-channel basis, through Customer Programming Software (CPS). In addition, you can have operator-selectable keys, operator-selectable keysets, and operator-selectable key erasure. If talkgroups are enabled in conventional, then the encryption keys are strapped to the talkgroups.

### Trunked Multikey

If both conventional and trunked applications are applied, strap the encryption keys for trunking on a per-talkgroup, or announcement-group basis. Also, a different key can be strapped to other features such as dynamic regrouping, failsoft, or emergency talkgroup. You can have operator-selectable key erasure.

#### 11.2.2

## MDC OTAR (Conventional Only)

This feature allows you to view or define the Motorola Data Communications (MDC) Over-the-Air Rekeying (OTAR) features. This feature is applied only when operating in secure encrypted mode. In addition to Rekey Requests, OTAR transmissions include Delayed Acknowledgments, and Power-up Acknowledgments.

Some of the selected options require configuration at the Key Management Controller (KMC) site to work properly.



**NOTE:** This feature must be programmed by a qualified radio technician. For more information, contact your system administrator.

#### 11.2.3

## Infinite UKEK Retention

This feature enables Unique Key Encryption Key (UKEK) to be permanently stored in the radio even when all the encryption keys are erased. Without this UKEK key, the radio cannot be rekeyed over the air. The Infinite UKEK Retention settings can be different for each secure profile.



**NOTE:** This feature must be programmed by a qualified radio technician. For more information, contact your system administrator.

#### 11.2.4

## Hear Clear

Hear-Clear is a noise reduction system that consists of Companding and Random FM Noise Canceller.

### Companding

Reduces the channel noise, such as OTA transmission that is predominantly present in UHF2 and 900 MHz channel with the following features:

#### Compressor

Reduces the background noise flow and the speech signal at transmitting radio.

#### Expander

Expands the speech while the noise flow remains the same at receiving radio.

### Random FM Noise Canceller (Flutter Fighter)

Reduces the unwanted effects of random FM noise pulses caused by channel fading under high Signal-to-Noise (S/N) conditions such as in a moving transportation. The fading effects, heard as audio pops and clicks, are canceled without affecting the desired audio signal.

The Random FM Noise Canceller operates only in receive mode.



**NOTE:** This feature must be programmed by a qualified radio technician. For more information, contact your system administrator.

### 11.2.5

## Loading Encryption Keys

#### Procedure:

1. Attach the Key Variable Loader (KVL) to your radio.

All other radio functions are locked, except power down, backlight, and volume.



**NOTE:** If the Multisystem Over-the-Air Rekeying feature is in use, the ASTRO profile name is displayed below `Keyloading`.

2. Press **Target** → **Load**.
3. Perform one of the following actions:
  - To load a single key, select **Key**.
  - To load multiple keys, select **Group**.
4. Select the required keys and press **Load** on the KVL.

**Result:** The KVL indicates that key load is successful.

### 11.2.6

## Selecting Encryption Keys

#### Procedure:

1. Press the **Key** menu item.

If the Multi-system Over-the-Air Rekeying feature is in use, the list of keys displayed is only for the current secure profile of the selected channel.

2. Select the required key or enter the key number.
3. To save the new key, press **Sel**.

If the selected key is not allowed, a tone sounds and the display shows `Illegal key`. If the selected key is erased, a tone sounds and the display shows `Key fail`.

### 11.2.7

## Selecting Keysets

This feature allows you to select one or more groups of encryption keys from among the available keys stored in the radio.

For example, you could have a group of three keys structured to one keyset, and another group of three different keys structured to another keyset. By changing keysets, you can automatically switch from one set of keys to the other.

Every channel to which one of the original keys was tied now has the equivalent new key instead.

#### Procedure:

1. Press the **Kset** menu item.

If the Multi-system Over-the-Air Rekeying feature is in use, the displayed keysets are only for the current secure profile of the selected channel.

2. Select the required keyset or enter the number of the keyset.

3. To save the new keysets, press **Sel**.

**Result:** The radio exits keyset selection and returns to the Home screen.

### 11.2.8

## Erasing Encryption Keys

If the Multi-system Over-the-Air Rekeying feature is in use, the keys erased are only for the current secure profile of the selected channel. The erase all option operates as configured by the dealer or system administrator.

### Procedure:

1. Press the **Eras** menu item.  
The display shows the last selected and stored encryption keys.
2. Select the required encryption key or enter the key number.
3. Press **Optn**.
4. Select the required option and press **Sel**.
5. Erase encryption keys by using one of the following options:
  - To erase a single or current key, select **Erase single keys?** and press **Yes** → **Sngl**.
  - To erase all keys, select **Erase single keys?** and press **Yes** → **All**You can abort this screen and return to the Home screen by pressing **Abrt**.

### 11.2.9

## Requesting Over-the-Air Rekey

If the Multi-system Over-the-Air Rekeying feature is in use, the rekey request is only for the current selected secure profile.

**Prerequisites:** Ensure that the Unique Key Encryption Key (UKEK) or Unique Shadow Key (USK) is loaded into the radio with the Key Variable Loader (KVL).

### Procedure:

1. Press the **Reky** menu item.
2. To send the rekey request, press the **PTT** button.
3. To exit the feature and transmit in normal mode, perform one of the following actions:
  - Press the **PTT** button again.
  - Press the **Home** button.
  - Press the **Emergency** button.

If the rekey operation fails, a negative tone sounds and the display shows `Rekey fail`



**NOTE:** A rekey operation failure indicates that your radio does not contain the UKEK or USK.



## Chapter 12

# Scan

This feature allows you to monitor traffic on different channels by scanning a programmed list of channels. Scanning is halted if you initiate a call and resumes when the call has ended.

### 12.1

## Turning Scan On or Off

### Procedure:

Press the **Scan** menu item.

### Result:

If the scan is turned on or off successfully, your radio shows the following indications:

If the scan is enabled, the display shows `Scan on` and the **Scan** status icon.

If the scan is disabled, the display shows `Scan Off`.

### 12.2

## Turning Scan On While Disregarding the Squelch Code (Conventional Channels Only)

You can still receive fleetwide, system-wide, dynamic regrouping, incoming telephone interconnect, and Private Conversation or Call Alert calls while scanning for activity. You can respond to these types of calls as you would normally on the selected channel. However, you can miss incoming Private Conversation or Call Alert calls when scanning different channels while in talkgroup scan.

### Procedure:

Press the **Mon** menu item.

**Result:** The display shows `Monitor on`.

### 12.3

## Deleting Nuisance Channel

If a channel continually generates unwanted calls or noise (termed as nuisance channel), you can temporarily remove the unwanted channel from the scan list. This feature is not applicable for priority channels or the designated transmit channel.

### Procedure:

1. Identify the nuisance channels.
2. When the radio detects a nuisance channel, press the **Nuis** menu item.



**NOTE:** The radio continues scanning the remaining channels in the list.

## 12.4

# Restoring Nuisance Channels

### Procedure:

To restore the deleted nuisance channel, perform one of the following actions:

- Stop and restart a scan.
- Mode change to another channel, and return to the original channel.
- Turn off the radio and then turn it on again.

## 12.5

# Changing Priorities Status While Scan is On

While the radio is scanning, the dynamic priority change feature allows you to temporarily change any channel in a scan list to the Priority-Two channel. You can change any channel except the Priority-One channel. This change remains in effect until scan is turned off. The scan then reverts to the original programmed setting.

### Procedure:

1. To change the priority of a non-priority channel in the scan list to Priority-Two, press **DYNP**.
2. To exit the scan list and resume scanning, press the **Home** button.

## 12.6

# Using the Hang Up Box

### Procedure:

To temporarily suspend Scan Mode operation, remove the microphone from the Hang Up Box (HUB).

You are allowed to use the control head while scan is suspended. However, Priority Member scanning is not suspended. This feature applies to all Scan Lists and Scan Types. Scan is resumed once the control head is returned to the holding clip and the programmed hangtime has elapsed.



**NOTE:** Priority Scan List members are continuously scanned only when the Scan List **Designated Tx Member** field is set to **Talkback** in the radio programming. Otherwise, all scan mode operation is suspended.

## Chapter 13

# Scan Lists

Scan lists are created and assigned to individual channels or groups. Your radio scans for voice activity by cycling through the channel or group. The sequence of scan is as specified in the scan list for the current channel or group.

Your radio supports different types of Scan Lists:

- Conventional Scan List
- Multi-System Talkgroup Scan
- Trunking Priority Monitor Scan List
- Voting Scan List

Refer to a qualified radio technician for the maximum number of Scan Lists to be programmed in your radio.

### 13.1

## Managing the Scan List

You can change the scan list members and priority.

#### Procedure:

1. Press the **ScnL** menu item.
2. Manage the scan list by using the following options:

Option	Actions
Viewing the scan list	To view members on the list, scroll through the list.
Adding or changing the priority of a channel in the scan list	<ol style="list-style-type: none"> <li>a. Select the required entry.</li> <li>b. To switch to the required priority status, press <b>Sel</b> once or more times.</li> </ol>
Deleting a channel from the scan list	<ol style="list-style-type: none"> <li>a. Select the required entry.</li> <li>b. Press <b>Del</b>.</li> </ol>
Viewing the next member of the scan list	<ol style="list-style-type: none"> <li>a. Select the required entry.</li> <li>b. Press <b>Rcl</b>.</li> </ol>

#### Result:

The radio shows one of following priority status icons and scenarios:

- A **Scan** icon indicates that the current channel is in the scan list as a nonpriority channel. The green LED illuminates.
- A **Priority-One Channel Scan** icon indicates that the current channel is in the scan list as the Priority-One channel. The green LED blinks rapidly. You hear all traffic on the Priority-One channel, regardless of traffic on nonpriority channels.
- A **Priority-Two Channel Scan** icon indicates that the current channel is in the scan list as the Priority-Two channel. The green LED blinks.

- No icon indicates that the current channel is deleted from the scan list.

## 13.2

# Changing the Scan List Status

### Procedure:

1. Press and hold the **Scan** side button.
2. Select the member that you want to edit.
3. Perform one of the following actions:
  - To add the currently displayed channel to the scan list, press **Select**.
  - To change the scan list status icon of the currently displayed channel, press **Select** once or a few times.
4. To select another scan list member, use the **Mode Knob**.

## 13.3

# Restoring Priorities in Scan Lists

### Procedure:

To restore the original channel priorities in a scan list, perform one of the following actions:

- Turn scan off, and then on.
- Change channels.
- Turn off the radio, and then turn on the radio.

## 13.4

# Intelligent Priority Scan

This feature allows you to add or delete conventional channels and trunking talkgroups from multiple systems into the priority scan lists.

When the radio locks onto a channel in the Intelligent Priority Scan list, the radio scans for higher priority member within the same Trunking or Conventional system.

## Chapter 14

# Connectivity

This section explains the management of connections between your radio and a variety of networks and other devices.

### 14.1

## SmartConnect

SmartConnect allows your radio to maintain voice communication when Land Mobile Radio (LMR) is out of range by switching to a Wi-Fi, LTE through Tethered Data Modem and Satellite through Ethernet. Before switching broadband connections, your radio compares the relative signal strength of the various broadband connection types to one another, as well as Land Mobile Radio (LMR).

Your radio remains or returns to LMR connection when the other broadband connections fall below the quality threshold. A radio operating on a lower priority broadband connection returns to the higher priority or quality connection while idle on SmartConnect.

Your radio can connect through a fixed Wi-Fi access point in buildings or in-vehicle Broadband modem. Examples are such as the following modems:

- Motorola Solutions VML750
- Sierra Wireless MP70
- Sierra Wireless GX450

Your radio displays the SmartConnect capable icon  on the SmartConnect enabled channel.

When connected to an available network, your radio displays SmartConnect connection icon .

Your radio displays `OUT OF RANGE` when both LMR and SmartConnect are unavailable.



#### **NOTE:**

This feature must be programmed by a qualified radio technician. For more information, contact your system administrator.

The Searching Site display is only visible on the radio when you enable this feature through the Customer Programming Software (CPS).

### 14.2

## Wi-Fi

You can connect your radio to a Wi-Fi network for wireless programming and SmartConnect features. Your service administrator programs the Wi-Fi Service Set Identifier (SSID) or network name that your radio can connect to.

### 14.2.1

## Turning Wi-Fi On or Off

### Turning Wi-Fi On

**Procedure:**

1. Press the **WiFi** menu item.
2. Press **On**.

### Turning Wi-Fi Off

**Procedure:**

1. Press the **WiFi** menu item.
2. Press **Off**.

### 14.2.2

## Selecting Wi-Fi Network

This feature allows you to view and select the available Wi-Fi network.

**Procedure:**

1. Press the **WiFi** menu item.
2. Press **On** → **List**.

If the radio displays `No network available`, press **Refresh**.

The **List** and **Refresh** buttons are not available when Wi-Fi is searching or connecting to a network.

3. Select the required network and press **Sel**.

**Result:** The radio displays the Wi-Fi status, selected network, and signal strength.

### 14.2.3

## Checking the Wi-Fi Configuration and Status of the Radio

**Procedure:**

Perform one of the following actions:

- Press and hold the programmed **Wi-Fi** button.
- Press the **WiFi** menu item.

**Result:** The display shows the current status of the Wi-Fi as described next.

**Searching**

Looking for available Wi-Fi networks that have been programmed into the radio.

In the process of connecting to a found Wi-Fi network.

**Connected**

Connected to one of the programmed Wi-Fi networks.

### No Service

No available networks or connection with one of the networks failed.

If the radio is Wi-Fi connected, the display shows a Wi-Fi Signal Strength indicator .

## 14.3

# Bluetooth®

This feature allows you to extend your radio functionality by connecting to external Bluetooth accessories. Use Motorola Solutions proprietary Operations Critical Wireless (OCW) devices with radios during critical operations. Other Bluetooth devices may or may not perform to the required standard.

The Bluetooth hardware resides on the Bluetooth capable radios instead of the Control Head. The E5 Control Head provides the Bluetooth Low Frequency-Motorola Proximity Pairing (LF-MPP) Pairing Location (a blue dot). You are required to purchase an external Bluetooth/GNSS/Wi-Fi antenna to enable the Bluetooth functionality.



**NOTE:** APX 5500 AN, APX 6500 AN, APX 6500 Li AN, and APX 7500 radio models do not support the Bluetooth feature. For other mobile radios, refer to the respective data sheet.

Your radio supports the following Bluetooth enabled devices or profiles:

- Headset (HSP)
- Dial Up Networking (DUN)
- Personal Area Networking (PAN)
- Serial Port (SPP)
- Generic Access Profile (GAP)
- General Attribute Profile (GATT)

### 14.3.1

## Turning Bluetooth On or Off

### Procedure:

1. Press the **BT** menu item.
2. Select **Status**.
3. Perform one of the following actions:
  - To turn on Bluetooth, press **On**.
  - To turn off Bluetooth, press **Off**.

### 14.3.2

## Pairing with Low Frequency-Motorola Proximity Pairing (LF-MPP) Feature

The range of Bluetooth operation when using a Motorola Critical Wireless (MCW) accessory is 10 meters line-of-sight communication. This range is achievable when there is an unobstructed path between the location of the signal transmitter, which is your radio and the location of the receiver, which is your device or accessory. Obstacles that can cause an obstruction in the line-of-sight include trees, buildings, mountains, cars, and others. For high degree of reliability, Motorola Solutions recommends to **not** separate the radio and the accessory. At the fringe areas of reception, both voice and tone quality will start to sound garbled or broken. To correct this problem, simply position the accessory and radio closer to each other within the

10 meter defined range to re-establish clear audio reception. In a multi-control head to one transceiver configuration, one Control Head must be assigned to Bluetooth for speaker, microphone, and LF-MPP interactions.

 **NOTE:** Once a COTS headset is paired to your radio, it is always connected. Therefore the battery life of the accessory is aligned with the Talk Time power consumption, not the Standby Time consumption.

**Prerequisites:**

Ensure that Bluetooth feature, Bluetooth tones, Bluetooth pairing type, Bluetooth timer, Bluetooth menu, and programmed buttons of your radio are enabled.

 **NOTE:** For more information, contact your system administrator.

**Procedure:**

1. Turn on the accessory.
2. Align the Bluetooth Pairing Location (a blue dot) on your radio and the accessory.

If pairing is successful, a tone sounds and your radio attempts to connect to the device.

If pairing is unsuccessful, your radio shows the following indications:

- A tone sounds.
- The display shows a negative notification.

If the connection is successful, your radio shows the following indications:

- A tone sounds.
- The display shows `<Device Type> connect failed`.

If the connection is unsuccessful, your radio shows the following indications:

- A tone sounds.
- The display shows `<Device Type> connect failed`.

For Bluetooth devices, the display shows `BT`.

For Wireless-Pair devices, the display shows `WP`.

### 14.3.3

## Standard Pairing Feature

The Bluetooth Standard Pairing feature enables your Bluetooth enabled radio to search for other Bluetooth enabled and discoverable devices.

 **NOTE:** Bluetooth tones, Bluetooth menu, and programmed buttons must be programmed by a qualified radio technician. For more information, contact your system administrator.

When a device is discovered, you can initiate your radio to send a pairing request to pair with the device.

### 14.3.3.1

## Searching and Pairing Bluetooth Devices

**Prerequisites:** Ensure that the Bluetooth and Bluetooth Visibility are turned on.

**Procedure:**

1. Press the **BT** menu item.



2. Select **Search Devices** and press **On**.  
To stop the search before the search timer expires, you must press **Stop**.
3. Select the required device for pairing and press **Sel**.

#### 14.3.3.2

### Turning Bluetooth Visibility On or Off

Turning on Bluetooth visibility enables other Bluetooth devices to search for your radio. Bluetooth visibility is turned off by default.

#### Procedure:

1. Press the **BT** menu item.
2. Select **Visibility**.
3. Perform one of the following actions:
  - To turn on the Bluetooth visibility, press **On**.
  - To turn off the Bluetooth visibility, press **Off**.

#### Result:

If the visibility mode is enabled, the display shows a positive notification.

When the timer expires, the display shows a negative notification. Repeat the procedure to turn on Bluetooth visibility.

#### 14.3.3.3

### Receiving Pairing Request from Other Devices

When your radio receives a pairing request from other devices, the display shows `<Device Friendly Name> pair request`.

#### Procedure:

Perform one of the following actions:

- To accept the pairing request, press **Ok**.
- To reject the pairing request, press **Cncl**.

#### 14.3.4

### PIN Authentication in Pairing

This feature allows your radio to verify the correct device to pair with using PIN authentication.



**NOTE:** The PIN authentication method is only applicable for Bluetooth version 2.1 and above.

#### 14.3.4.1

### Pairing the Authentication PIN when Receiving a Pairing Request

#### Procedure:

1. When the display shows a pair request, press **Ok**.

Your radio only supports HSP, DUN, GAP, PAN, and SPP Bluetooth profiles.

The display shows `Compare PIN: XXXXXX`.

2. Press **Ok** if the pin is correct.

If the pairing is successful or unsuccessful, your radio shows the following indications:

**Table 11: Pairing the Authentication PIN when Receiving a Pairing Request Scenario**

Scenario	Outcome
If pairing is successful,	your radio displays <code>Pairing in progress...., &lt;Device Friendly Name&gt; paired followed by &lt;Device Friendly Name&gt; connected.</code>
If pairing is unsuccessful when the pairing timer expires,	your radio displays <code>&lt;Device Friendly Name&gt; pair failed.</code>
If pairing is unsuccessful when the connecting timer expires,	your radio displays <code>&lt;Device Friendly Name&gt; connect failed.</code>
If the PIN is correct but the profiles are not supported,	your radio displays <code>BT profiles not supported</code> and returns to Home screen.



**NOTE:**

For Bluetooth devices, the display shows `BT`.

For Wireless-Pair devices, the display shows `WP`.

#### 14.3.4.2

### Pairing the Authentication PIN with the Generated Numeric PIN

**Prerequisites:** Follow the procedure in [Searching and Pairing Bluetooth Devices on page 80](#) to search for available Bluetooth devices.

**Procedure:**

1. To initiate pairing, select the required device and press **Sel**.

Your radio only supports HSP, DUN, GAP, PAN, and SPP Bluetooth profiles.

If successful, the display shows `Pairing in progress...` followed by a randomly generated numeric PIN, `Compare PIN: XXXXXX`.

If unsuccessful, the display shows `BT profiles not supported` and returns to the **Available Dev** screen.

2. To continue pairing your radio and the device, press **Ok**.

If successful, the display shows `Pairing in progress, <Device Friendly Name> paired, or Connecting in progress...` followed by `<Device Friendly Name> connected` and returns to the **Bluetooth feature** screen.

If unsuccessful, one of the following scenarios occurs:

- If the PIN numbers are different, the display shows `<Device Friendly Name> pair failed`.
- If the connection fails, the display shows `<Device Friendly Name> connect failed`.

The display returns to the **Available Dev** screen.

**Result:**

For Bluetooth devices, the display shows `BT`.

For Wireless-Pair devices, the display shows `WP`.

### 14.3.5

## Turning Bluetooth Audio On or Off



**NOTE:**

Bluetooth audio routing can be configured in the Customer Programming Software (CPS) to route the audio to the radio internal speaker. The audio routes to the radio speaker if the radio Remote Speaker Microphone (RSM) is not connected. For more information, contact your system administrator.

For Bluetooth (BT) Push-to-Talk (PTT) press, the active microphone can be configured in CPS to transmit from either the RSM, the radio microphone, or the BT headset. If the configured device is not available, audio transmission reverts to BT headset.

**Procedure:**

1. Press the **BT** menu item.
2. Select **Bluetooth spkr**.
3. Perform one of the following actions:
  - To turn on Bluetooth audio, press **On**.
  - To turn off Bluetooth audio, press **Off**.
4. To return to the Home screen, press **Exit**.

### 14.3.6

## Adjusting the Volume of the Radio from the Bluetooth Audio Device

**Prerequisites:** Ensure that the Bluetooth audio device is connected to the radio.

Your radio can control the volume of MCW, OCW, and other Bluetooth enabled audio devices that are capable of remote volume control.

**Procedure:**

At the Bluetooth audio device, adjust the volume up or down.

**Result:** Your radio shows the following indications:

- A tone sounds.
- The display shows `Volume XX`.

### 14.3.7

## Viewing and Clearing the Bluetooth Enabled Device Information

### Procedure:

1. Press the **BT** menu item.
2. Select **Devices** and press **Sel**.
3. To view the status of devices that are paired or connected, scroll through the list of <Device Friendly Name>.  
If there are no active Bluetooth devices paired or connected, the display shows `No devices`.
4. To clear a device from the list, select the required device and press **Clr** → **Yes**.

### Result:

If the device is successfully cleared, the display shows <Device Friendly Name> cleared.

If the device is not successfully deleted, your radio shows the following indications:

- A tone sounds.
- The display shows <Device Friendly Name> clear failed and then returns to the previous screen.

**Postrequisites:** If the Re-Pair Timer is set to infinite and the radio keys are cleared, clear all previously linked devices keys too. See your accessories manual for further details.

### 14.3.8

## Clearing All Bluetooth Devices Information

### Procedure:

Perform one of the following actions:

- Press and hold the programmed **Bluetooth On/Off** button.
- Select **Devices** and press **Clr** → **Yes**.

### Result:

If successful, the display shows a positive notification.

If unsuccessful, a tone sounds and the display shows a negative notification.

For Bluetooth devices, the display shows `BT`.

For Wireless-Pair devices, the display shows `WP`.

**Postrequisites:** If the repair timer is set to infinite and the radio keys are cleared, clear all previously linked devices keys too. See your accessories manual for further details.

### 14.3.9

## Editing the Bluetooth Friendly Name

**Prerequisites:** Contact your system administrator to program this feature on your radio.

### Procedure:

1. Press the **BT** menu item.

2. Select **Friendly name** and press **Edit**.
3. Enter the required Bluetooth Friendly Name.
4. To save and return to the Bluetooth feature screen, press **Ok**.

**Result:**

For Bluetooth devices, the display shows **BT**.

For Wireless-Pair devices, the display shows **WP**.

#### 14.4

## ASTRO 25 (P25) Programming Over Project 25 (POP25)

Also known as Over-the-Air Programming, this feature allows configuration data and firmware to be upgraded to your radio over-the-air. Full use of the radio is retained during the data transfer without interrupting communication.

If the upgrade happens on the ASTRO 25 and ASTRO Conventional systems, the upgrade pauses to give priorities to voice call, and continues after the voice call ended. If the upgrade happens on a Wi-Fi network, the upgrade process runs concurrently with voice calls.

Once a configuration upgrade is downloaded to your radio, you can install new changes immediately, or delay changes to be installed on the radio when it is being powered up.

#### 14.4.1

### Responding to Upgrade Notifications

The display shows **Upgrade?** and a tone sounds every 30 seconds until you accept, delay, or reject the request.



**NOTE:** Do not remove the power cable or turn off the radio during the firmware upgrade process. If your radio has problems upgrading over-the-air, consult a qualified technician for details.

**Procedure:**

Respond by performing one of the following actions:

- To accept the upgrade request, press **Acpt**.
- To delay the upgrade request, press **Dlay**.
- To reject the upgrade request, press **Rej**.

**Result:** One of the following scenarios occurs:

- If you choose to accept, the display shows **Programming Dont power off**. The radio resets to install the upgrade.



**NOTE:** The radio cannot be used while the upgrade is being installed. You must ensure to accept the upgrade at a convenient time.

- If you choose to delay, a configuration data upgrade is installed automatically at the next power up. In the case of a firmware upgrade, the radio prompts **Upgrade?** again at the next power up.
- If you choose to reject, the display shows **Upg Aborted**. The radio continues to function with the current configuration until it gets reprogrammed.

## Chapter 15

# Location



**NOTE:** The Location feature is addressed as Global Positioning System (GPS) across the manual as the naming convention of the buttons and strings remain the same as the legacy feature of GPS.

The availability and accuracy of this location information and the calculation duration can vary depending on the environment in which you are using the GPS feature. For example, GPS location fixes are difficult to obtain indoors, in covered locations, between high buildings, or in situations where you have not established a clear broad view of the sky.

If adequate signals from multiple satellites are available, your GPS feature only provides an approximate location, usually within 10 meters from your actual location, but sometimes farther away.

Sometimes, the GPS feature cannot complete a location calculation successfully. You will then see a message indicating that your radio cannot connect to enough visible satellites.

To maximize the ability of your radio to determine a fix, take note of the following guidelines:

- For your initial fix, hold the radio in the face position.
- Stay in the open as the GPS feature works best when there is nothing between your radio and the open sky.

### 15.1

## Outdoor Location Feature

This feature allows you to determine your current location using a location menu, and your current distance and bearing in relation to another location. Your radio location can be requested and reported over-the-air.

Your radio stores up to a maximum of 60 programmable location coordinates, also known as waypoints. When the memory is full, the next waypoint automatically replaces the oldest waypoints in the radio.

The radio also stores four programmed waypoints. These coordinates cannot be deleted.

The following table shows the differences between programmable waypoints and programmed waypoints.

<b>Programmable Waypoints</b>	<b>Programmed Waypoints</b>
User-configurable location coordinates.	Fixed location coordinates: <ul style="list-style-type: none"><li>• Home</li><li>• Emergency</li><li>• Last Known Location</li><li>• Destination</li></ul>
Only the alias is editable, not the coordinates.	The Home and Destination coordinates are editable.
Coordinates can be deleted one at a time, or all at once.	Coordinates cannot be deleted.

### 15.1.1

## Turning Location On or Off

### Procedure:

1. Press the **Loc** menu item.
2. Perform one of the following actions:
  - To turn on Location, press **Optn** → **Turn On GPS** → **Sel**.
  - To turn off Location, press **Optn** → **Turn Off GPS** → **Sel**.
3. To return to the Home screen, press **Exit**.

### 15.1.2

## Accessing Location

### Procedure:

1. Press the **Loc** menu item.
2. Press **Optn** → **Turn On GPS** → **Sel**.
3. To check the last successful location fix, select the longitude, time, and date.
4. To access the current location, press **Rfsh**.
5. To return to the Home screen, press **Exit**.

### Result:

If the radio successfully obtains the current location, the display shows the following information:

- Current Location
- UTC (Zulu) Time
- Date



**NOTE:** If the location signal is present, the location coordinates are automatically updated every five seconds.

### 15.2

## Location Format

This feature allows you to select different display formats of GPS location.

The following GPS location formats are available:

- Lat/Long (DD)
- Lat/Long (DDM)
- Lat/Long (DMS)
- UTM/UCS
- SLD99



**NOTE:** When you send your location to another radio, the receiving radio displays the location in its selected format.

15.3

## Managing Waypoints



**Prerequisites:** Ensure that your radio shows the current location on the screen.

**Procedure:**

Manage waypoints by using the following options:

Option	Actions
Saving waypoints	<ol style="list-style-type: none"><li>a. Press the <b>Optn</b> menu item.</li><li>b. Perform one of the following actions:<ul style="list-style-type: none"><li>• Select <b>Save as Waypt.</b></li><li>• Select <b>Save as Home.</b></li><li>• Select <b>Save as Dest..</b></li></ul></li><li>c. Press <b>Sel.</b></li><li>d. If required, edit the auto-generated waypoint with the keypad.</li><li>e. Press <b>OK.</b></li></ol>
Viewing saved waypoints	<ol style="list-style-type: none"><li>a. Press the <b>Optn</b> menu item.</li><li>b. Select <b>Waypoints</b> and press <b>Sel.</b></li><li>c. Select the required waypoint.</li><li>d. Press <b>Optn.</b></li><li>e. To view the time and date of the selected waypoint, select <b>View</b> and press <b>Sel.</b></li></ol>
Editing waypoint aliases	<ol style="list-style-type: none"><li>a. Press the <b>Optn</b> menu item.</li><li>b. Select <b>Waypoints</b> and press <b>Sel.</b></li><li>c. Select the required waypoint and press <b>Optn.</b></li><li>d. Select <b>Edit Name</b> and press <b>Sel.</b></li><li>e. Enter the new alias.</li><li>f. Press <b>OK.</b></li></ol>



Option	Actions
Editing waypoint coordinates	<ol style="list-style-type: none"> <li>a. Press the <b>Optn</b> menu item.</li> <li>b. Select <b>Waypoints</b> and press <b>Sel</b>.</li> <li>c. Perform one of the following actions: <ul style="list-style-type: none"> <li>• Select <b>[Home]</b> and press <b>Optn</b>.</li> <li>• Select <b>[Destination]</b> and press <b>Optn</b>.</li> </ul> </li> <li>d. Select <b>Edit location</b> and press <b>Sel</b>.</li> <li>e. To select the number or coordinates, use the following control buttons and press <b>Edit</b>. <ul style="list-style-type: none"> <li>• To move to the previous number or coordinates, press the <b>Left</b> navigation button.</li> <li>• To move to the next number or coordinates, press the <b>Right</b> navigation button.</li> <li>• To change the North (N), South (S), East (E), or West (W) direction, press the <b>Up</b> or <b>Down</b> navigation button.</li> </ul> </li> <li>f. To change the number or coordinates, use the following control buttons and press <b>OK</b>. <ul style="list-style-type: none"> <li>• To move one space to the left, press the <b>Left</b> navigation button.</li> <li>• To move one space to the right, press the <b>Right</b> navigation button.</li> <li>• To delete any unwanted characters, press <b>Del</b>.</li> <li>• To return to the previous screen, press <b>Cncl</b>.</li> </ul> </li> <li>g. Press <b>OK</b>.</li> </ol> <p> <b>NOTE:</b> You can only edit programmed coordinates of Home and Destination.</p>
Deleting a single saved waypoint	<ol style="list-style-type: none"> <li>a. Press the <b>Optn</b> menu item.</li> <li>b. Select <b>Waypoints</b> and press <b>Sel</b>.</li> <li>c. Select the required saved waypoint and press <b>Optn</b>.</li> <li>d. Select <b>Edit name</b> and press <b>Del</b>.</li> <li>e. Press <b>Yes</b>.</li> </ol>
Deleting all saved waypoints	<ol style="list-style-type: none"> <li>a. Press the <b>Optn</b> menu item.</li> <li>b. Select <b>Waypoints</b> and press <b>Sel</b>.</li> <li>c. Select the required saved waypoint and press <b>Optn</b>.</li> <li>d. Select <b>Delete All</b> and press <b>Sel</b>.</li> <li>e. Press <b>Yes</b>.</li> </ol> <p> <b>NOTE:</b> You cannot delete programmed waypoints.</p>

Option	Actions
Measuring the distance and bearing from waypoints	<ol style="list-style-type: none"><li>a. Press the <b>Optn</b> menu item.</li><li>b. Select <b>Dist frm here</b> and press <b>Sel</b>.</li><li>c. Select the required waypoint and press <b>Sel</b>.</li></ol> <p>The display shows the distance and bearing from the current to the selected coordinates.</p>

## 15.4

# Location Feature in Emergency Mode

When the Emergency feature is activated, the radio exits the Location menu and returns to the Home screen.

You can view the channel that triggers the emergency signal.

You can reenter the Location menu while still in Emergency mode as long as Silent Emergency is not activated.

If you have disabled the Location feature on your radio, it automatically turns back on when Emergency mode is activated.

If there is a solid location signal during Emergency operation, the current location and the location information received is saved as Emergency and Last Known Location respectively.

## 15.5

# Peer-Location on the Display (ASTRO Conventional)

This feature is only available for radio-to-radio voice transmissions, dispatch call, and selective call.

The transmitting radio and receiving radio must be configured to enable the sending and receiving of the Global Positioning System (GPS) coordinates.



**NOTE:** If the receiving radio is operating in a Mixed Mode channel and the voice transmission is from the conventional ASTRO system, the radio can only receive the peer-location coordinates.

This feature is operable in a Scan Active channel, or Scan Talkback channel.

After receiving a voice transmission with GPS coordinates enabled on the receiving radio, the display shows the available full location, or short location coordinates.

### Full location coordinates

- PTT ID (optional)
- Longitude and latitude
- Relative distance or direction

### Short location coordinates

- PTT ID (optional)
- Longitude and latitude



**NOTE:**

If the transmitting radio is stale at the location after a period of time, the receiving radio display shows the last known location. If the transmitting radio does not have GPS, or the receiving radio could not decode the GPS signal of the received signal, the receiving radio display shows the location as unknown.

## Chapter 16

# Mission Critical Geofence (ASTRO 25 Trunking)

This feature allows your radio to use the Global Positioning System (GPS) receiver to determine its location at frequent intervals, and evaluate if the radio is within the Geofence area in real time. Geofence is a virtual perimeter based on the GPS to define a geographical area on earth.

When your radio enters the predefined Geofence area, your radio receives the Dynamic Regroup command from the system, and immediately connects to a Dynamic Regroup talkgroup. The radio display shows the new selected Dynamic Regrouped talkgroup with green intelligent light for your attention. Voice Announcement is also available to support this feature.

Any new text messages received at Geofence are displayed immediately on the radio display.



**NOTE:**

If the radio is set up in DVRS, only mobile radio is supported for this feature.

### 16.1

## Entry to the Geofence Area

The Voice Announcement and Text Messaging Service (TMS) display in this feature are optional. These features must be configured to enable you to hear, and see these indicators.

When the radio enters a Geofence area, the radio immediately sends a message `ACK` back to the system.

The radio searches the current zone for the channel with same talkgroup assigned as the Dynamic Talkgroup and also with same system ID of current trunk system. Once matched, the radio display shows the first matched and connected channel alias.

If there is no channel with matching Talkgroup ID and trunk system ID, the radio display shows the channel alias of `<DYNAMIC talkgroup>`.

Once the radio is connected, you hear a dynamic regroup tone. The radio display shows `<DYNAMIC channel>`. The radio display shows the green intelligent backlight, and you hear a Voice Announcement.



**NOTE:**

When the radio loses the Global Positioning System (GPS) signal, the GPS icon blinks and the radio sounds two high-pitched tones repetitively to indicate that the GPS has failed to operate. The radio display shows the red intelligent light.

If the first matched channel is not configured with Voice Announcement, no Voice Announcement is played.

The system sends a message to your radio. The radio display shows a direct text message content without any user operation. This message indicates that you are currently present in a Geofence area. This TMS remains open on the display until you press exit or home to exit this screen.



**NOTE:** If there is another incoming text message before you exit the previous message, the message screen is refreshed to show the latest message.

When the radio exits the Geofence area, your radio reverts to original channel or newly assigned talkgroup. The radio display shows the new channel together with Voice Announcement to indicate the changes. Voice Announcement of the new channel only works if that channel is configured with Voice Announcement.

## 16.2

# Entry to Mission Critical Geofence

When the radio enters the predefined Geofence area, the radio displays <Geofence Alias>. The radio display also shows the intelligent backlight, and you hear a Voice Announcement. Zone and channel alias of the Geofence area is displayed.

If the radio is set to manual, you can choose either to proceed with zone and channel change, or cancel the change.

The radio then connects to the designated talkgroup. The radio displays the talkgroup alias and dynamic regroup tone sounds. The level changes for transmit power and, your radio shows a direct text message content without any user operation.

**NOTE:**

The availability of the Voice Announcement (VA), Text Messaging Service (TMS) display, Intelligent Backlight, and Transmit Power Level alerts depend on your radio configuration. The VA can be programmed to alert continuously, or momentarily.

If Site Selectable Alert (SSA) is enabled, the radio mutes any alert that is received when entering the Geofence area, and unmutes when exiting.

## 16.3

# Exit from Mission Critical Geofence

When the radio exits the Geofence area, the radio reverts to the original transmit power level, intelligent lighting, channel, or newly assigned talkgroup. Voice announcement (VA) is canceled or you hear a programmed VA tone. The radio displays the new channel, and a message is received to indicate the changes.

## Chapter 17

# Contacts

This feature provides address-book capabilities on your radio. Each entry corresponds to an alias (name) and ID (number) that you use to initiate a call. Contact entries are alphabetically sorted according to the entry alias.

Each entry, depending on context (conventional, trunking, or phone), associates with one to five IDs according to the following types of calls:

- Phone Call
- Private Call
- Selective Call
- Call Alert

Each entry within Contacts contains the following information:

- Call Alias (Name)
- Call ID (Number)
- Call Type (Icon)
- WACN ID (ASTRO 25 Trunking IDs only)
- System ID

Your radio must be programmed to allow you to add, edit, or delete the contact entries.

Your radio also supports a maximum of 50 call lists. Each list can store up to 100 IDs.



**NOTE:** Your radio is programmed with a few contacts per Call Lists. Check with your dealer or system administrator for more information.

### 17.1

## Managing Contact Entries

### Procedure:

1. Press the **Cnts** menu item.
2. Manage contact entries using the following options:

Option	Actions
Adding new contact entries	<ol style="list-style-type: none"> <li>a. Select <b>[New Contact]</b> and press <b>Sel</b>.</li> <li>b. Enter the name and press <b>OK</b>.</li> <li>c. Select <b>[Add Number]</b> and press <b>Sel</b> → <b>Edit</b>.</li> <li>d. Select the required channel and press <b>OK</b>.</li> <li>e. Select <b>Number 1</b> and press <b>Edit</b>.</li> <li>f. Enter the number and press <b>OK</b>.</li> <li>g. Press <b>Done</b>.</li> </ol>

Option	Actions
Editing entry aliases	<ul style="list-style-type: none"> <li>a. Select the required entry and press <b>Optn</b>.</li> <li>b. Select <b>Edit</b> and press <b>Sel</b>.</li> <li>c. Select the required entry alias and press <b>Edit</b>.</li> <li>d. Enter the name and press <b>OK</b>.</li> <li>e. Press <b>Done</b>.</li> </ul>
Editing entry IDs	<ul style="list-style-type: none"> <li>a. Select the required entry and press <b>Optn</b>.</li> <li>b. Select <b>Edit</b> and press <b>Sel</b>.</li> <li>c. Select the required entry ID and press <b>Edit</b>.</li> <li>d. Enter the number and press <b>OK</b>.</li> <li>e. Press <b>Done</b>.</li> </ul>
Editing call types	<ul style="list-style-type: none"> <li>a. Select the required entry and press <b>Optn</b>.</li> <li>b. Select <b>Edit</b> and press <b>Sel</b>.</li> <li>c. Select <b>Type</b> and press <b>Edit</b>.</li> <li>d. Select the required call type and press <b>OK</b>.</li> <li>e. Press <b>Done</b>.</li> </ul>
Deleting contact entries	<ul style="list-style-type: none"> <li>a. Select the required entry and press <b>Optn</b>.</li> <li>b. Select <b>Del</b> and press <b>Sel</b> → <b>Yes</b>.</li> </ul>
Adding contacts to a call list	<ul style="list-style-type: none"> <li>a. Select the required entry and press <b>Optn</b>.</li> <li>b. Select <b>Add to CallLst</b> and press <b>Sel</b>.</li> <li>c. Select the required call list and press <b>Add</b>.</li> </ul>

**Result:** If successful, the display shows a positive notification and returns to the main **Contacts** screen.

## Chapter 18

# Recent Calls

Recent call menu allows you to view the recent incoming and outgoing call information.

You can view the information of the following type of calls:

- Call Alert
- Selective Call
- Private Call
- Phone Call (Outgoing Only)
- Emergency Call (Incoming Only)



**NOTE:** The Log Dispatch Calls Enable field need to be enabled in Customer Programming Software (CPS) for your radio to log the dispatch call.

### 18.1

## Viewing Recent Calls

### Procedure:

1. Press the **Rcnt** menu item.
2. Scroll through the list.
3. To view recent Emergency Calls, press **Emer**.
4. To return to all recent calls, press **All**.
5. To return to the Home screen, press **Exit**.

### 18.2

## Deleting Calls

This feature allows you to delete calls from the Recent Calls list.

### Procedure:

Delete calls by using the following options:

Option	Actions
Deleting all calls	<ol style="list-style-type: none"><li>a. Press <b>Optn</b>.</li><li>b. Select <b>Delete Calls</b>.</li><li>c. Select <b>All Calls</b>.</li><li>d. Press <b>Yes</b>.</li></ol>

Option	Actions
Deleting non-emergency calls	<ul style="list-style-type: none"><li>a. Press <b>Optn.</b></li><li>b. Select <b>Delete Calls.</b></li><li>c. Select <b>Non-Emer Calls.</b></li><li>d. Press <b>Yes.</b></li></ul>

**Result:**

When you have successfully deleted all calls, your display shows `All calls deleted` and the Recent Calls list is empty.

When you have successfully deleted non-emergency calls, your display shows `Non-emer calls deleted` and the Recent Calls list only contains emergency calls.



Chapter 19

# Instant Recall

This feature allows you to save and play back the recent received calls. All saved calls are removed upon radio power cycle.

19.1

## Saving and Playing Back Calls

**Procedure:**

Save and play back recorded calls by using one of the following options:

Option	Actions
Playing back and saving recorded calls using the menu	<ul style="list-style-type: none"> <li>a. Press the <b>Rcnt</b> menu item.</li> <li>b. Select <b>Recent Convs</b> and press <b>Sel</b>.</li> <li>c. To playback the call, select the required call and press <b>Play</b>.</li> <li>d. To stop the call playback, press <b>Stop</b>.</li> <li>e. To save the call, select the required call and press <b>Save</b>.</li> </ul>
Playing back saved calls from the menu	<ul style="list-style-type: none"> <li>a. Press the <b>Rcnt</b> menu item.</li> <li>b. Select <b>Saved Convs</b> and press <b>Sel</b>.</li> <li>c. To playback the call, select the required call and press <b>Play</b>.</li> <li>d. To stop the call playback, press <b>Stop</b>.</li> </ul>
Saving the recorded calls using the programmed <b>Record Playback</b> button	Press and hold the <b>Record Playback</b> button.
Playing back saved calls using the programmed <b>Record Playback</b> button	<ul style="list-style-type: none"> <li>a. To playback the call, press the <b>Record Playback</b> button.</li> <li>b. To skip to the next call, press the <b>Record Playback</b> button again.</li> </ul> <p> <b>NOTE:</b>                      If only a single saved call is available, the play back skips to the end of the call.</p>



**NOTE:**

Any tone or button press can stop an ongoing playback call except for specific buttons. For more information, contact your system administrator.

When a call is received, your radio stops the ongoing playback calls. To ignore the receiving call, press the programmed **Record Playback** button in three seconds.

## Chapter 20

# In-Call User Alert

This feature allows the radio to remain muted to affiliated talkgroup calls or dispatch calls while operating on the current Trunking Personality or conventional channel respectively.

Group and individual Pages unmute the radio for the alert tone to sound. The radio also unmutes to individual radio-to-radio calls. This feature is very useful when a radio-user prefers not to hear affiliated talkgroup or dispatch calls traffic, but needs-to remain in radio contact. For an In-Call User Alert enabled channel, the Voice Mute button-press or the Voice Mute menu-selection allows the radio-user to toggle on and off Voice Mute functionality.

### 20.1

## Enabling or Disabling In-Call User Alert

This feature allows you to mute the voice transmission of the current zone and channel.

**Prerequisites:** Ensure that you are in Home mode where the default zone and mode are being displayed.

**Procedure:**

Enable or disable In-Call User Alert by pressing the **VMut** menu item.

**Result:** If this feature is enabled, the radio displays a positive notification. The radio is muted to all conventional dispatch calls and affiliated trunking group calls.

## Chapter 21

# Quik Call II

This feature allows you to broadcast a series of distinct and recognizable tones before a voice transmission from the dispatcher or a radio.

The broadcasting dispatcher or radio user can select this programmed Quik Call II tone transmission to be sent to an individual talkgroup or over the entire system. Each tone is distinctive to indicate different situation or different broadcaster.

 **NOTE:** The receiving radio must be configured with the matching Quik Call II tone from the transmitting radio, in order for the receiving radio to sound the selected tone followed by the preconfigured alert tone.

### 21.1

## Initiating Quik Call II Transmissions

**Prerequisites:** Program tones into the Tone Signaling List on broadcasting and transmitting radios.

**Procedure:**

1. Press the **QCII** menu item.
2. Select the required broadcast tone.
3. Initiate Quik Call II Transmissions by using one of the following options:

Option	Actions
Broadcasting the selected tone	Press the <b>PTT</b> button.
Broadcasting the selected tone and making a call	<ol style="list-style-type: none"> <li>a. Press and hold the <b>PTT</b> button.</li> <li>b. Wait for the tone to end and speak into the microphone.</li> <li>c. To listen to the call, release the <b>PTT</b> button.</li> </ol>

## Chapter 22

# Status

The Status feature allows you to send data calls to the dispatcher about a predefined status. Each status can have up to a 14-character name. For trunking, a maximum of eight status conditions are possible. For conventional, a maximum of 16 status conditions are possible.

## 22.1

# Sending Status

### Procedure:

1. Press the **Sts** menu item.
2. Perform one of the following actions:
  - Select the required status.
  - For Model 3.5, enter a number corresponding to the location in the status list.
3. To send the status, press the **PTT** button.
4. To return to the Home screen, press the **Home** button.

### Result:

If acknowledgement is received, your radio shows the following indications:

- Four tones sound.
- The display shows `Ack received`.



**NOTE:** If the **Display Last Acknowledged User Status/Message** is enabled, the display shows the last acknowledged status.

If acknowledgement is not received, your radio shows the following indications:

- A tone sounds.
- The display shows `No acknowledge`.

No traffic is heard on trunked channels while Status is selected. If the radio detects no Status activity for six seconds, an alert tone sounds until you press the **Home** or **PTT** button.

## Chapter 23

# Message

You can send a message to a dispatcher to request or indicate a significant occurrence. Your radio is capable of transmitting as many as 16 predefined messages. You can select the message from a programmed list by scrolling through the list or searching through the index. The message is transmitted by pressing the **Push-To-Talk (PTT)** button.

### 23.1

## Sending Messages

### Procedure:

1. Press the **Msg** menu item.
2. Perform one of the following actions:
  - Select the required message.
  - Enter a number corresponding to the location in the message list.
3. To send a message, press the **PTT** button.
4. To return to the Home screen, press the **Home** button.

No traffic is heard on trunked channels while Message is selected. If the radio detects no message activity for 6 s, an alert tone sounds until you press the **Home** or **PTT** button.

### Result:

If acknowledgment is received, your radio shows the following indications:

- Four tones sound.
- The display shows `Ack received`.



**NOTE:** If the **Display Last Acknowledged User Status/Message** is enabled, the display shows the last acknowledged message.

If acknowledgment is not received, your radio shows the following indications:

- A tone sounds.
- The display shows `No acknowledge`.

## Chapter 24

# Call Alert Paging

This feature allows your radio to work like a pager.

If other users are away from their radios or if they are unable to hear their radios, you can send them an individual call alert page. You can also verify if a radio is active on the system.

Depending on how your radio is programmed, if there is no answer after the maximum ring time or when you press the **PTT** button for an Enhanced Private Call, the radio automatically sends a call alert page.



**NOTE:** This feature must be programmed by a qualified radio technician.

### 24.1

## Sending Call Alert Page



**NOTE:** If the feature inactivity timer is enabled, your radio automatically exits the feature when your radio is left idle long enough for the time to expire. You hear a tone upon feature exit.

### Procedure:

Send a call alert page by using one of the following options:

Option	Actions
Sending a call alert page using the radio menu <b>Page</b>	<ol style="list-style-type: none"><li>Press the <b>Page</b> menu item.</li><li>Select the required ID.</li><li>To send the page, press the <b>PTT</b> button.</li></ol>
Sending a call alert page using the radio menu <b>Call</b>	<ol style="list-style-type: none"><li>Press the <b>Call</b> menu item.</li><li>Select the required ID or alias.</li><li>To call, press the <b>PTT</b> button. If the target radio does not respond after a programmed period, the display shows <i>Send page?</i>.</li><li>To send the page, press <b>Yes</b>.</li></ol>

### Result:

If the call alert page is sent successfully, your radio shows the following indications:

- Four tones sound.
- The display shows a positive notification.
- The radio returns to the Home screen.

If the call alert page is not acknowledged, the radio shows the following indications:

- A tone sounds.
- The display shows a negative notification.

## 24.2

# Receiving Call Alert Page

When you receive a Call Alert page, you hear four repeating alert tones, and the green LED blinks. If Call Alert Tone Auto Reset is enabled, you hear one alert tone, and the green LED blinks. The **Call Received** icons blink and the display shows `Page received`.

### Procedure:

Perform one of the following actions:

- To answer the call, press the **PTT** button.
- To clear the Call Alert page, press any button.

## Chapter 25

# Automatic Registration Service

Automatic Registration Service (ARS) provides an automated data application registration for your radio. When you turn on the radio, the device automatically registers with the server. Data applications within the fixed network determine the presence of a device on the system and send data to the device.

The ARS consists of the following mode:

- ARS Server Mode (Default mode)
- ARS Non-server Mode

## 25.1

### Selecting ARS Mode

#### Procedure:

Select the ARS Mode by using one of the following options:

Option	Actions
Selecting the ARS Mode using the radio menu	<ol style="list-style-type: none"><li>Press the <b>Chan</b> menu item.</li><li>Select the required channel.</li><li>To confirm the displayed zone and channel, press the <b>Sel.</b></li></ol>
Selecting the ARS Mode using the Mode Knob	<ol style="list-style-type: none"><li>After the zone you want is displayed, toggle until the display shows the required channel.</li><li>Rotate the <b>Mode Knob</b> to the required channel.</li><li>To confirm the displayed zone and channel, press the <b>Sel.</b></li></ol>

#### Result:

One of the following scenarios occurs:

- In ARS Server Mode, the display shows the User Login Indicator icon, the zone, and ARS server channel.
- In ARS Non-Server Mode, the display shows the User Login Indicator icon, the zone, and ARS non-server channel.
- If the channel or mode selected is unprogrammed, the display shows `Unprogrammed`.



Chapter 26

# User Login Feature

This feature allows you to take on a friendly username such as Text Messaging Service (TMS).

You can still send text messages without logging in as a user. The user login feature only enables the recipient of your message to identify you as the sender by assigning a username to your message. This feature is only applicable for Land Mobile Radio (LMR) Messaging.

 **NOTE:** Valid characters for a username entry are capital letters (A–Z), small letters (a–z), numbers (0–9), symbols (\*, #, -, /), and the space character.

The maximum length for a username is eight characters. Usernames are not case-sensitive in server mode but are case-sensitive in non-server mode.

A predefined username can be invalid because the programming software used to set predefined usernames allows you to set usernames comprising eight characters or more.

## 26.1

# Logging In as a User

**Procedure:**

1. Press the **User** menu item.
2. At the User Login screen, use one of the following options:

Option	Actions
Entering the user name using the keypad	<ol style="list-style-type: none"> <li>a. Select <b>[ID Entry]</b> and press <b>Edit</b>.</li> <li>b. Enter the user name.</li> <li>c. To submit, press <b>OK</b>.</li> </ol>
Selecting a predefined user name	<ol style="list-style-type: none"> <li>a. Select the required predefined user name.</li> <li>b. Press <b>Sel</b>.</li> </ol>
Selecting a predefined user name using fast scroll	<ol style="list-style-type: none"> <li>a. For fast scroll through the list, press and hold the <b>Up</b> or <b>Down</b> button.</li> <li>b. Select the required predefined user name.</li> <li>c. Press <b>Logn</b>.</li> </ol>

 **NOTE:** If the selected predefined username has more than eight characters, or an invalid character in it, the display momentarily shows *Invalid ID*.

3. Press **PIN**.
4. Enter your Personal Identification Number (PIN) number.  
 The maximum PIN length is four digits. The PIN number appears as asterisks.
5. Press **Logn**.

**Result:**

One of the following scenarios occurs:

- In ARS Server Mode, the display shows the User Login Indicator icon, the ID, and *In progress*, with **Cncl**.
- In ARS Non-Server Mode, the display shows the User Login Indicator icon, the ID, and *Logged in*, with **Logt** and **Exit**.
- In non-ARS enabled mode, the display shows *Offline*, with **Logt** and **Exit**.

If user login is successful, the display shows the Successful User Login Indicator (IP indicator) icon and a positive notification.

If the user name or PIN is invalid and login fails, the User Login Failure Indicator (IP indicator) icon blinks and the display shows a negative notification.

## 26.2

# Logging Out

**Prerequisites:** When the data application registration is completed, you can log out.

**Procedure:**

1. Press the **Logt** menu item.
2. Perform one of the following actions:
  - To clear all your private data, press **Yes**.
  - To keep your private data, press **No**.



**NOTE:** Private data refers to all messages in the text messaging **Inbox**, **Draft**, and **Sent** folder. The next user is able to access the **Inbox**, **Draft**, and **Sent** messages if private data is not deleted.

## Chapter 27

# Text Messaging Service

Text Messaging Service (TMS) allows you to send and receive messages and run database queries directly from your radios. The maximum number of characters allowed for a text message is 200 characters.

The types of text messages available are:

- A new text message (free form message).
- A predefined message (quick text message).
- An edited quick text message.
- A query (ASTRO 25 Advanced Messaging Solution).

Quick Text messages are messages that are predefined and usually consist of messages that are used most frequently. Each Quick Text message has a maximum length of 50 characters.

### 27.1

## Viewing Text Messages

The inbox can hold up to 30 messages. The radio saves sent messages in the Sent folder. The Sent folder stores a maximum of 10 messages. The oldest message in the folder is deleted when the 11<sup>th</sup> message comes in.

#### Procedure:

View text messages by using one of the following options:

Option	Actions
Viewing text messages from the inbox	<ol style="list-style-type: none"> <li>a. Access the inbox by performing one of the following actions:               <ul style="list-style-type: none"> <li>• Press and hold the programmed <b>Data Feature</b> button or programmed <b>TMS Feature</b> button.</li> <li>• Press the <b>TMS</b> menu item. Select <b>Inbx</b> and press <b>Sel</b>.</li> </ul> </li> <li>b. To view the text message, select the required ID or alias, and press <b>Sel</b>.</li> <li>c. Perform one of the following actions:               <ul style="list-style-type: none"> <li>• To reply the message, press <b>Rply</b>.</li> <li>• To delete the message, press <b>Del</b>.</li> <li>• To return to the previous screen, press <b>Back</b>.</li> </ul> </li> </ol>

Option	Actions
Viewing sent text messages	<ol style="list-style-type: none"> <li>a. Access the Text Messaging System (TMS) screen by performing one of the following actions:                             <ul style="list-style-type: none"> <li>● Press the programmed <b>Data Feature</b> button or programmed <b>TMS Feature</b> button.</li> <li>● Press the <b>TMS</b> menu item.</li> </ul> </li> <li>b. Press <b>Sent</b>.</li> <li>c. To view the message, select the required ID or alias, and press <b>Sel</b>.</li> <li>d. Perform one of the following actions:                             <ul style="list-style-type: none"> <li>● To configure the message settings, press <b>Optn</b>.</li> <li>● To delete the message, press <b>Del</b>.</li> <li>● To return to the previous screen, press <b>Back</b>.</li> </ul> </li> </ol>

 **NOTE:** The icon at the top-right corner of the screen indicates the status of the message.

## 27.2

# Composing New Text Messages

### Procedure:

1. Press the **TMS** menu item.
2. Select **Compose** and press **Sel**.
3. Select **Text Message** and press **Sel**.
4. Enter your new text message.

 **NOTE:** You can select the **Drft** option to save your message in the Drafts folder to send it later.

## 27.3

# Sending Text Messages

### Procedure:

Send text messages by using one of the following options:

Option	Actions
Sending New Text Messages	<ol style="list-style-type: none"> <li>a. Compose a new text message.</li> <li>b. Press <b>Optn</b> → <b>Send</b>.</li> <li>c. Perform one of the following actions:                             <ul style="list-style-type: none"> <li>● Select the required address.</li> <li>● Select <b>[Other Recpnt]</b> and press <b>Edit</b>. Enter the address entry.</li> </ul> </li> <li>d. Press <b>Send</b>.</li> </ol>

Option	Actions
Sending Quick Text Messages	<ol style="list-style-type: none"> <li>a. Press the <b>TMS</b> menu item.</li> <li>b. Select <b>Comp</b> and press <b>Sel</b>.</li> <li>c. Select <b>List</b>.</li> <li>d. Select the required text message and press <b>Sel</b>.</li> <li>e. At the <b>Compose</b> screen, if required, edit the message with the keypad.</li> <li>f. Press <b>Optn</b>.</li> <li>g. Select <b>Send</b> and press <b>Sel</b>.</li> <li>h. Perform one of the following options: <ul style="list-style-type: none"> <li>• Select the required address. The message is sent.</li> <li>• Select <b>[Other Recptn]</b> and press <b>Edit</b>. Enter the address entry and press <b>Send</b>.</li> </ul> </li> </ol>
Sending Sent Text Messages	<ol style="list-style-type: none"> <li>a. View the Sent Text Message.</li> <li>b. Press <b>Optn</b> → <b>Send</b>.</li> <li>c. Perform one of the following options: <ul style="list-style-type: none"> <li>• Select the required address.</li> <li>• Select <b>[Other Recptn]</b> and press <b>Edit</b>. Enter the address entry.</li> </ul> </li> <li>d. Press <b>Send</b>.</li> </ol>



**NOTE:** You can append a priority status and a request reply to your message.

**Result:**

If the message is successfully sent, your radio shows the following indications:

- A tone sounds.
- The display shows a positive notification.

27.4

## Priority Status and Request Reply for New Text Messages

Before sending your message, you can add a priority status, request reply, or both to your message.

27.4.1

### Appending Priority Status and Request Reply to Text Messages

**Prerequisites:** Ensure that you compose an outgoing message before performing this procedure.

**Procedure:**

1. Press the **Optn** menu item.

2. Depending on your requirement, use one of the following options:
  - To append priority status to text messages, select **Mark Important**.
  - To append request reply to text messages, select **Req Reply**.
  - To append priority status and request reply to text messages, select **Mark Important** and press **Sel**. Then select **Req Reply**.
3. Press **Sel**.

**Result:**

The **Priority Status** and **Request Reply** icons appear accordingly beside the normal message icon on the label bar.



**NOTE:** The **Priority Status** icon on a message does not imply that the message gets higher priority than other messages when being transmitted. This icon is embedded into a message to notify the recipient that the message is important.

### 27.4.2

## Removing Priority Status and Request Reply from Text Messages

**Prerequisites:** Ensure that you compose an outgoing message before performing this procedure. The text message is already appended with a priority status, request reply, or both.

**Procedure:**

1. Press the **Optn** menu item.
2. Depending on your requirement, use one of the following options:
  - To remove priority status from text messages, select **Mark as Normal**.
  - To remove request reply from text messages, select **No Req Reply**.
  - To remove priority status and request reply from text messages, select **Mark as Normal** and press **Sel**. Then select **No Req Reply**.
3. Press **Sel**.

**Result:** The display shows the normal message icon on the label bar.

### 27.5

## Receiving Text Messages

When you receive a text message, the **New Message** icon appears and the display momentarily shows **New msg**.



**NOTE:** If the message you receive is flagged with the **Request Reply** icon, you must manually respond to the sender that you have received the message. The system does not automatically send a notification to acknowledge that the message is received.

**Procedure:**

When you receive a text message, perform one of the following actions:

- Press and hold the programmed **Data Feature** button or the programmed **TMS Feature** button.
- Press the **TMS** menu item.

**Result:** The radio displays the inbox with a list of IDs or aliases. The sender of the latest received message is arranged at the top of the list.

27.6

## Replying to Text Messages

 **NOTE:** The original date and time stamp, address, and message content is automatically appended to the reply message.

**Procedure:**

1. Select the required ID or alias.
2. Press **Sel** → **Rply**.
3. Use one of the following options:

Option	Actions
Composing a new message	Select <b>New</b> and press <b>Sel</b> .
Selecting a predefined message	<ol style="list-style-type: none"> <li>a. Select <b>List</b> and press <b>Sel</b>.</li> <li>b. Select the required predefined message and press <b>Sel</b>.</li> </ol>

4. Enter or edit your message.
5. When you have completed your message, press **Optn**.  
To return to the previous screen, press **Back** at any time. You can append a priority status, request reply, or both to your message.
6. Select **Send Message** and press **Sel**.

**Result:** The display shows a positive notification.

27.7

## Accessing the Drafts Folder

The Drafts folder stores the messages that are saved previously. This folder can hold up to 10 messages. The oldest draft in the folder is deleted when the 11<sup>th</sup> message comes in.

**Procedure:**

1. Press the **TMS** menu item.
2. Select **Drafts** and press **Sel**.
3. Select the required text message and press **Sel**.
4. Perform one of the following actions:
  - To edit the message, press **Edit**.
  - To delete the message, press **Del**.
  - To return to the previous screen, press **Back**.

27.8

## Deleting Text Messages

**Procedure:**

Delete text messages by using one of the following options:

<b>Option</b>	<b>Actions</b>
Deleting a text message	<p><b>a.</b> From the <b>Inbox</b>, <b>Draft</b>, or <b>Sent</b> screen, select the required message.</p> <p><b>b.</b> Press <b>Del</b>.</p>
Deleting all text messages	<p><b>a.</b> To access the Messaging feature screen, perform one of the following actions:</p> <ul style="list-style-type: none"><li>● Press the programmed <b>Data Feature</b> button or the programmed <b>TMS Feature</b> button.</li><li>● Press the <b>TMS</b> menu item.</li></ul> <p><b>b.</b> Select <b>Inbox</b> or <b>Sent</b>, and press <b>Clr</b>.</p> <p><b>c.</b> Press <b>Yes</b>.</p>



## Chapter 28

# Monitor Feature

The monitor feature ensures that a channel is clear before transmitting.

The lack of static on a digital channel when you switch from analog to digital radios is not an indication that the radio is malfunctioning. Digital technology quiets the transmission by removing the noise from the signal and allows only the clear voice or data information to be heard.

### 28.1

## Monitoring Channels

### Procedure:

Depending on your preference and programmed functions, monitor channels by using one of the following options.

Option	Actions
Monitoring channels in Conventional Mode	<ol style="list-style-type: none"> <li>a. Lift the microphone off the hook.</li> <li>b. Listen for activity on that channel.</li> <li>c. If necessary, adjust the <b>Volume Knob</b>.</li> <li>d. If you hear no activity, press and hold the <b>PTT</b> button to start your conversation.</li> </ol>
Monitoring channels in Trunked Mode	<ol style="list-style-type: none"> <li>a. Lift the microphone off the hook.</li> <li>b. Press the <b>PTT</b> button.</li> <li>c. If two tones sound, or no tone sounds and the Call Transmit indication illuminates, proceed with your message.</li> <li>d. To receive transmission, release the <b>PTT</b> button.</li> </ol>

If you are not in the range of the system, a tone sounds and the display shows **OUT OF RANGE**.

### 28.2

## Monitoring Conventional Mode

This feature allows you to monitor channel traffic on conventional channels by defeating the coded squelch. This way, you can listen to another active user on the channel and you do not take over the conversation of another user.

**Prerequisites:** Ensure that your radio is programmed to receive Private-Line® (PL) calls.

### Procedure:

1. To activate monitoring, perform one of the following actions:
  - At Home mode where the default zone and channel are displayed, press the **Mon** menu item.
  - Take the Control Head off the hook.

2. To deactivate monitoring, press the **Mon** menu item again.

When you turn monitor off, you do not hear all channel traffic. If you try to transmit on a receive-only channel, you hear an invalid tone until you release the **PTT** button.

## Chapter 29

# Remote Monitor

This feature allows the system administrator to turn on the microphone of a targeted radio with a subscriber alias or ID.

When remote monitor feature is activated, the audio transmission can be configured in Customer Programming Software (CPS) to route the audio to the radio internal microphone, wired Remote Speaker Microphone (RSM), or Bluetooth wireless microphone.

In life-threatening or critical situations, the system administrator can remotely monitor any audible activity surrounding the targeted radio.

## Chapter 30

# Transmit Inhibit

The Transmit Inhibit feature allows you to stop all transmission including voice and data. The radio can receive messages but is not able to reply the acknowledgment request of the received message.

This feature is available for APCO 25 Trunking, Type II Trunking, and Conventional operations for all APX radios.

You can physically control the transmission of the radio especially during operation in hazardous environments. An environment is considered hazardous if radio transmission could initiate an explosion or other dangerous reactions.

### 30.1

## Enabling or Disabling Transmit Inhibit

You can enable or disable Transmit Inhibit using the radio menu or Ignition Sense Line

#### Procedure:

Perform one of the following actions:

- To enable or disable transmit inhibit, press the **TxIn** menu item.
- To enable transmit inhibit, turn off the ignition through Ignition Sense Line.
- To disable transmit inhibit, turn on the ignition through Ignition Sense Line.

#### Result:

If Transmit Inhibit is enabled, your radio shows the following indications:

- A tone sounds.
- The display shows `Tx inhibit on`.



**NOTE:** If you press the **PTT** button, a negative tone sounds.

If Transmit Inhibit is disabled, your radio shows the following indications:

- A tone sounds.
- The display shows `Tx inhibit off`.



#### **NOTE:**

The status of the Transmit Inhibit does not change after the radio powers up.

The **TxIn** softkey works, only if the Ignition Sense Line is turned on. If the Ignition Sense Line is turned on, you can always turn on or off the Transmit Inhibition using the **TxIn** softkey. If the Ignition Sense Line is turned off, the **TxIn** softkey is suspended, and the Transmit Inhibition function is always off.

If PTT TX Inhibit is enabled on a multicontrol head and you press **PTT** on the active Control Head, pressing any programmable button on the other Control Head causes a continuous low-pitched tone. This tone is the Talk Prohibit Tone and the display shows `Tx inhibit`. You can stop this occurrence by pressing **PTT** again on the active Control Head.

30.2

## Smart PTT (Conventional Only)

Smart PTT is a per-personality, programmable feature used to keep radio users from talking over other radio conversations. When Smart PTT is enabled in your radio, you cannot transmit on an active channel.

The following table shows the variations of Smart PTT.

Mode	Description
Transmit Inhibit on Busy Channel with Carrier	You cannot transmit if traffic is detected on the channel.
Transmit Inhibit on Busy Channel with Wrong Squelch Code	You cannot transmit on an active channel with a squelch code or (if secure-equipped) encryption key other than your own. If the PL code is the same as yours, the transmission is not prevented.
Transmit Inhibit on Correct NAC	You cannot transmit when the radio is in a NAC operated digital voice call channel.
Transmit Inhibit on Status Symbols	You cannot transmit when the radio is in a digital voice call with the last signal status bit as “inbound busy” or “unknown.”

## Chapter 31

# Dynamic Regrouping (Trunking Only)

This feature allows the dispatcher to temporarily reassign selected radios to a particular channel to communicate with each other.

When your radio is dynamically regrouped, it receives a dynamic regrouping command and automatically switches to the dynamically regrouped channel. You hear a tone and the display shows the name of the dynamically regrouped channel.

When the dispatcher cancels dynamic regrouping, the radio automatically returns to the previous zone and channel.

If you access a zone or channel that has been reserved as a dynamically regrouped mode for other users, you hear an invalid tone.

### 31.1

## Classification of Regrouped Radios

The dispatcher can classify regrouped radios into Select Enabled or Select Disabled categories.

### Select Enabled

Select-enabled radios are free to change to any available channel, including the dynamic-regrouping channel, once you have selected the dynamic-regrouping position.

### Select Disabled

Select-disabled radios cannot change channels while dynamically regrouped. The radio is forced to remain on the dynamic-regrouping channel.

The Scan and Private Call features are unavailable when your radio is Select Disabled.

### 31.2

## Requesting a Reprogram (Trunking Only)

You can notify the dispatcher when you want to reprogram a new dynamic regrouping assignment.

### Procedure:

To send a reprogram request to the dispatcher, press the **Rpgm** menu item.

### Result:

If the dispatcher acknowledges the reprogram request, your radio shows the following indications:

- Five beeps sound.
- The display shows a positive notification.

Your radio returns to the Home Screen.

If the dispatcher does not acknowledge the reprogram request in six seconds, your radio shows the following indications:

- A tone sounds.
- The display shows a negative notification.

## Chapter 32

# Dynamic Zone Programming

Dynamic Zone Programming (DZP) provides one or more Dynamic Zones to store frequently used channels for conventional or trunking.



**NOTE:** Your radio must be programmed for you to use this feature. At least one zone in the radio must be a nondynamic zone.

### 32.1

## Saving Channels in the Dynamic Zone

### Procedure:

1. Enter a dynamic zone by performing the following actions:
  - a. Press the **Zone** menu item.
  - b. Select **<# Dynamic Zone Channels>** and press **Sel**.  
The radio returns to the Home screen and displays the selected Dynamic Zone Channel.
2. Press the **ZnPr** menu item.
3. Press **Edit**.
4. Select **List Selection** and press **Sel**.
5. Select the required zone and press **Sel**.
6. Select the required channel and press **Sel**.
7. To return to the Home screen, press **Exit**.

### 32.2

## Deleting Channels in the Dynamic Zone

### Procedure:

1. Enter a dynamic zone by performing the following actions:
  - a. Press the **Zone** menu item.
  - b. Select **<# Dynamic Zone Channels>** and press **Sel**.  
The radio returns to the Home screen and displays the selected Dynamic Zone Channel.
2. Press the **ZnPr** menu item.
3. Select the required saved dynamic channel and press **Del**.
4. To return to the Home screen, press **Exit**.

**Result:** The Home screen shows **<Dynamic Zone Channels>**. If the deleted channel is the home channel, the Home screen shows **<Zone Name>"Blank"**.

## Chapter 33

# Zone-to-Zone Cloning

Zone Cloning clones conventional zones from one radio to another.

You can select the followings zones from a source radio and clone them into a target radio.

- Clone enabled zones
- Dynamic Zones
- Multiple Private Line (MPL)

You can clone the zones by connecting the source radio and target radio with a clone cable. The target radio must be digital, band, and FCC mandate compatible with the source radio.

### 33.1

## Cloning Zones

#### Procedure:

1. On the source radio, press the **Clon** menu item.
2. To select the source zone, press **Sel**.

If the radio is compatible and connected, the display shows `Target radio connected` and the zone clone status.

If the radio is not compatible, the radio displays `Target radio incompatible`. Press **Ok** and the radio returns to the previous screen.

3. To accept the source zones selection, press **Next**.

One of the following scenarios occurs:

- If you select a single source zone, press **Sel** to select the target zones for cloning.
- If you select multisource zones, the display shows `Confirm target` and the automatically selected target zones and source zones mapping.
- If the selected multisource zones exceed the last clone target zone, the radio displays the following indications alternatively:

**Table 12: Multisource Zones Selection Indications**

Models	Results
Model 3.5	<ul style="list-style-type: none"><li>○ <code>&lt;#&gt; src zones unselected</code></li><li>○ <code>Sel exceed max tgt zone</code></li><li>○ <code>Protected tgts not supported</code></li></ul>



4. To begin cloning, press the **Clon** menu item.



**NOTE:** If you selected protected target zones, you are required to enter the password.

**Result:**

If cloning is successful, your radio shows the following indications:

- A tone sounds.
- The display shows `Clone successful` and the source zone alias.

If cloning is unsuccessful, your radio shows the following indications:

- A tone sounds.
- The display shows `Clone failed`.



**NOTE:** The target radio enters programming mode during cloning and resets when cloning is completed.

## Chapter 34

# Multiple Private Line

Multiple Private Line (MPL) is a feature that allows user to modify the PL/DPL codes of the current mode by selecting from a predefined list of codes. For the purpose of accessing different communication sub-groups, repeaters and others, user no longer need to program multiple channels of the same frequency with different PL/DPL codes.

The feature supports the following MPL selection Mode:

**Table 13: MPL Selection Mode**

Selection Mode	Description
Dynamic	The MPL List selection/functionality is automatically updated (and active on the radio current channel) as users scroll through the available MPL List selections.
Static	While users are scrolling through the radio available MPL List selections, MPL functionality does not change until a new MPL List is manually selected.

### 34.1

## Selecting Multiple Private Line

**Prerequisites:** Ensure that this feature is enabled in the codeplug and the radio is in Conventional Mode.

**Procedure:**

1. Perform one of the following actions:
  - Press the programmable Multiple Private Line (MPL) Side button.
  - From the **Home** screen, tap  **More**.
2. Tap the required MPL.

The Radio Control Widget displays the selected MPL.

## Chapter 35

# Multiple Control Head Features

This feature allows your transceiver to control the combinations of control heads on APX Mobile.

You can use the Controller Area Network (CAN) cables to connect in any configuration that does not exceed 131 feet. For further information, refer to the following Installation Manuals:

- *APX Mobile Radios and Control Heads Installation Manual, 6878215A01*
- *APX 8500 Mobile Radio Installation Manual, MN003109A01*
- *Enhanced Single Band Mobile Radio Installation Manual, MN005720A01*

The Multiple Control Head (MCH) feature consists of two modes that can be programmed through Customer Programming Software (CPS):

- All Active mode
- One Active mode

### 35.1

## Setting the ID of the Initial Control Head

This feature allows you to set up the control head in the Front Panel Programming (FPP) mode. During the setup, the control heads are defined as Control Head Number 1, Control Head Number 2, Control Head Number 3, and Control Head Number 4.

### Procedure:

1. Turn off the radio.
2. Press and hold the left-most **Menu Select** button and the **Emergency** button at the same time.
3. To turn on the radio and the control head, continue to press the two buttons and the **Power** button.  
The radio and the control head are turned on in the FPP mode. The radio displays the ID number of the control head.
4. To change the ID number of the control head, turn the **Mode Knob**.  
The radio displays `Please Wait` and the ID number of the new control head.
5. To exit the FPP mode and turn off the radio, press the **Power** button.
6. To set the ID number for other attached control heads, repeat from [step 1](#) to [step 5](#).

### 35.2

## All Active Mode

The All Active mode enables all connected control heads attached to the radio to operate concurrently with each other. When you activate a feature on one control head, the rest of the control heads have the same activated features and indicators on their respective display.

### 35.2.1

## Activating or Deactivating Intercom in All Active Mode

The intercom feature allows one control head user to talk to another control head user in a MCH configuration. At any given time, when a control head being operated has priority for the intercom call, all other control heads are blocked until the PTT button is released on active control head. This feature only applies to control heads in the All Active mode.

#### Procedure:

1. To activate the intercom feature of any of the control heads, press the **Intc** menu item.
2. To start an intercom transmission, press the **PTT** button.

All control heads that are attached receives the same intercom call. The display of the control heads receiving the intercom call shows the alias or ID number of the transmitting control head.

3. To deactivate the intercom feature, press **Exit**.

The intercom feature also deactivates when you change the mode. If your radio is on an emergency channel, pressing of the **Emergency** button or the emergency footswitch button on any control head also deactivates the intercom feature.

### 35.3

## One Active Mode

One Active mode enables only one control head to be visibly active at a time in a two control head system.

The **Volume** knob, **DIM** button, **Front/Rear (F/R)** softkey, **Emergency**, the Emergency footswitch, and VIP inputs remain active on the inactive control head, while all other controls are disabled.

The VIP input control head is configurable in the CPS and VIP should be attached to the control head selected in the CPS.

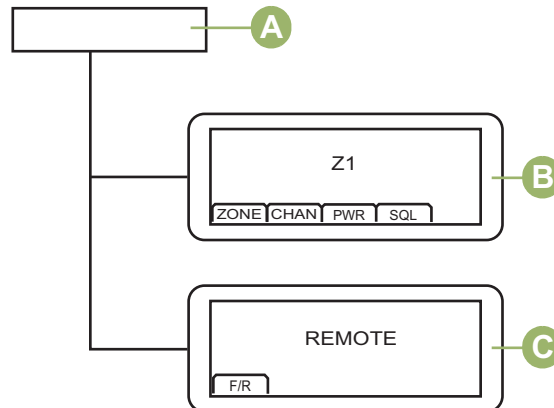

Item	Description
A	Transceiver
B	Active Radio
C	Non-Active Radio

You can change the command between the two control heads by pressing the **Menu Select** button directly below F/R, or the **Menu Select** button on the keypad microphone.

## Chapter 36

# Action Consolidation Mode

This feature allows your radio to execute a series of actions by a programmed button.

The Action Consolidation Mode has the following features:

- Activates the lightbar with patterns
- Activates the siren
- Switches to predefined zone or channel for Talkaround or Direct Mode
- Sends a status update to dispatch for Talkaround or Direct Mode
- Sends a Global Positioning System (GPS) report

All other activities are blocked during Action Consolidation, except Group Call.



**NOTE:** Action for Siren, Lightbar, or Gunlock can only be activated one at a time in Action Consolidation mode.

### 36.1

## Activating the Action Consolidation Activities

### Procedure:

Press the programmed **Action Consolidation** button.

The display shows the activities of the required programs run by the radio.

### Result:

If successful, the radio reverts to normal when Action Consolidation activities are complete.

If unsuccessful, the display shows `Action Consolidation Failed`. The **Failed Actions** screen appears. The screen shows a list of actions that failed to run.

### 36.2

## Deactivating the Action Consolidation Activities

### Procedure:

To end running activities of the Action Consolidation, perform one of the following actions:

- Press the **Home** button.
- Press the **PTT** button to transmit.



**NOTE:** The Siren and Lightbar activities run by Action Consolidation are not deactivated, but continue until they are completely or manually disabled.

- Press the **Emergency** button.



**NOTE:** Receiving an emergency message also ends Action Consolidation activities.

### Result:

The radio shows the following indications:

- The display shows `Action Consolidation Canceled`.
- The radio ends the transmission.

For the **Home** button or **PTT** button option, the radio reverts to Home mode.

For the **Emergency** button option, the radio launches an emergency.

## Chapter 37

# Front Panel Programming

You are able to customize certain feature parameters in Front Panel Programming (FPP) to enhance the use of your radio.

The radio can be programmed in two ways:

- Front Panel Programming (FPP) using the front panel controls of the radio.
- Customer Programming Software (CPS), with the radio connected to a PC computer.

There are two methods to program a channel within a zone. Either:

- Select the zone and channel through the radio interface, and then initiate the FPP feature. Or,
- Initiate the FPP feature, and then select the zone and channel.



**NOTE:** When any of the Rx parameters such as Rx frequency, Rx PL, Rx DPL, and Rx NAC is changed, FPP automatically copies these Rx parameter values to the equivalent Direct operation (also known as Talkaround operation) parameters. If you use FPP to change the Rx frequency to be the same as the Tx frequency and subsequently use the CPS to read then write to the radio, Direct/ Talkaround mode will operate differently from when a receive channel parameter value is changed through FPP. Refer to the CPS help files for a description of Direct/ Talkaround Mode operation, in respect to a CPS write to the radio.

### 37.1

## Initiating the FPP Feature

**Prerequisites:** Remove the universal connector seal or any other accessories attached to the radio.

### Procedure:

1. Press the **FPP** menu item.
2. Perform one of the following actions:
  - To program zones that are not password protected and only supported in Federal FPP, press **OK**.
  - To program a set of zones, of which one or more are password protected, enter the password and press **OK**.

### Result:

For the nonpassword protected choice, the radio displays `Radio Param` and `Zn/Ch Param`.

For the password protected choice, the radio displays `Password: *****`.

### 37.2

## Changing Password (Optional)

Radios from the Motorola Solutions factory are provisioned with a blank password.

**Prerequisites:** To access the protected channels, press **OK** when the `Enter Old Password` prompts you to change the password.

### Procedure:

1. Press **EDIT**.

2. Enter the old password.
3. Enter the new password.
4. To accept the entry, enter the new password again.

### 37.3

## Viewing the List of Channel Parameters

#### Procedure:

1. Press the **FPP** menu item.
2. Perform one of the following actions:
  - To view the unprotected FPP-Enabled zone list, press **OK** without entering the password.
  - To view the entire FPP-Enabled zone list, enter the password and press **OK**.



#### NOTE:

If the current zone is FPP-Enabled, your radio displays the current zone. If the current zone is not FPP-Enabled, your radio displays the unprotected FPP-Enabled zone in the list first.

If unprotected FPP-Enabled zones are unavailable, such as all zones are protected, pressing **OK** without entering the password generates a negative indicator tone and remains in the get-password state.

3. To view the list of channels in the required FPP-Enabled zone, press **VIEW**.
4. To view the list of channel parameters that are FPP programmable, press **VIEW** again.

**Result:** The first programmable channel parameter is shown.

### 37.4

## Editing Channel Parameters

**Prerequisites:** Perform steps in [Viewing the List of Channel Parameters on page 128](#).

#### Procedure:

1. Edit channel parameters by using the following options:

Option	Actions
Editing Tx or Rx	<ol style="list-style-type: none"><li>a. To find Tx or Rx, press the <b>Left</b> or <b>Right</b> navigation button.</li><li>b. To modify the Tx or Rx frequency of the selected channel, press <b>EDIT</b>.</li><li>c. Enter the required value.</li></ol>
Editing Tx PL or Rx PL	<ol style="list-style-type: none"><li>a. To find Tx DPL or Rx DPL, press the <b>Left</b> or <b>Right</b> navigation button.</li><li>b. To modify the TX DPL or Rx DPL code of the selected channel, press <b>EDIT</b>.</li><li>c. Enter the required value.</li></ol>



Option	Actions
Editing Tx DPL or Rx DPL	<ol style="list-style-type: none"> <li>a. To find Tx DPL or Rx DPL, press the <b>Left</b> or <b>Right</b> navigation button.</li> <li>b. To modify the TX DPL or Rx DPL code of the selected channel, press <b>EDIT</b>.</li> <li>c. Enter the required value.</li> </ol>
Switching between Normal or Invert DPL Operation	<ol style="list-style-type: none"> <li>a. To switch between normal and invert DPL modes, press <b>INVT</b>.</li> </ol>
Editing Tx NAC or Rx NAC	<ol style="list-style-type: none"> <li>a. To find Tx NAC or Rx NAC, press the <b>Left</b> or <b>Right</b> navigation button.</li> <li>b. To modify the TX NAC or Rx NAC of the selected channel, press <b>EDIT</b>.</li> <li>c. Perform one of the following actions when entering the required value:           <ul style="list-style-type: none"> <li>• To scroll through A, B, C, 2, multiple press <b>2</b>.</li> <li>• To scroll through D, E, F, 3, multiple press <b>3</b>.</li> <li>• To enter the digits, press <b>0, 1, 4–9</b>.</li> </ul> </li> </ol>
Switching among Rx Analog, Mixed, and Digital Mode	<ol style="list-style-type: none"> <li>a. To find Rx Type, press the <b>Left</b> or <b>Right</b> navigation button.</li> <li>b. Press <b>EDIT</b>.</li> <li>c. Select <b>ANALOG</b>, <b>MIXED</b>, or <b>DIGITAL</b> by pressing the <b>Up</b> or <b>Down</b> navigation button.</li> </ol>
Switching between Tx Analog and Digital Mode	<ol style="list-style-type: none"> <li>a. To find Rx Type, press the <b>Left</b> or <b>Right</b> navigation button.</li> <li>b. To change the Rx mode of operation of the selected channel, press <b>EDIT</b>.</li> <li>c. To switch to <b>MIXED</b>, press the <b>Up</b> or <b>Down</b> navigation button.</li> <li>d. Press the <b>Tx Type</b> menu item.</li> <li>e. To change the Tx mode of operation of the selected channel, press <b>EDIT</b>.</li> <li>f. To switch between <b>ANALOG</b> and <b>DIGITAL</b> modes, press the <b>Up</b> or <b>Down</b> navigation button.</li> </ol>

Option	Actions
Switching among Narrow, Medium, and Wide Bandwidth	<ul style="list-style-type: none"> <li>a. To find Bandwidth, press the <b>Left</b> or <b>Right</b> navigation button.</li> <li>b. To change the bandwidth of the selected channel, press <b>EDIT</b>.</li> <li>c. To switch between <b>12.5 kHz</b>, <b>20.0 kHz</b>, and <b>25.0 kHz</b>, press the <b>Up</b> or <b>Down</b> navigation button.</li> </ul>
Editing Channel Name	<ul style="list-style-type: none"> <li>a. To find <i>&lt;chan name&gt;</i>, press the <b>Left</b> or <b>Right</b> navigation button.</li> <li>b. To change the name of the selected channel, press <b>EDIT</b>.</li> <li>c. Use the keypad to enter alphanumeric characters for the channel name.</li> </ul>
Editing Zone Name	<ul style="list-style-type: none"> <li>a. To find <i>&lt;zone name&gt;</i>, press the <b>Left</b> or <b>Right</b> navigation button.</li> <li>b. To change the name of the selected zone, press <b>EDIT</b>.</li> <li>c. Use the keypad to enter alphanumeric characters for the zone name.</li> </ul>
Setting Zone Password Protection On or Off	<ul style="list-style-type: none"> <li>a. To find Protect, press the <b>Left</b> or <b>Right</b> navigation button.</li> <li>b. To change the protection status of the selected FPP-Enabled zone, press <b>EDIT</b>.</li> <li>c. To switch between password protection on/off for the selected FPP-Enabled zone, press the <b>Up</b> or <b>Down</b> navigation button.</li> </ul>
Editing the Talkgroup	<ul style="list-style-type: none"> <li>a. To find the Talkgroup, press the <b>Left</b> or <b>Right</b> navigation button.</li> <li>b. To change the talkgroup of the current channel, press <b>EDIT</b>.</li> <li>c. To edit the talkgroup ID or alias of the current talkgroup, use the numeric keypad.</li> </ul>

2. Press **OK**.

3. To return to the channel selection menu, press **DONE**.



**NOTE:**

Select a **Tx PL** or **Rx PL** frequency of zero for Carrier Squelch operation.

**Tx Type** becomes editable only when **Rx Type** is set to **MIXED** and a DVRS Convention System is not referenced, otherwise it is set to the same mode as **Rx Type**.

To edit **Tx PL**, **Rx PL**, **Tx DPL**, and **Rx DPL**, the PL Setting must be set to **Disabled**.

If the PL setting is set to **ALL**, **Rx** or **Tx**, there is no **Edit** selection available to change the codes for **Tx PL**, **Rx PL**, **Tx DPL**, or **Rx DPL**.

If the PL setting is set to **Rx**, you can only edit **Tx PL** and **Tx DPL** codes.

If the PL setting is set to **Tx**, you can only edit **Rx PL** and **Rx DPL** codes.

## Chapter 38

# Radio Lock

This Radio Lock feature allows you to lock your radio with a password for security.

The default password is **0123456789**. When you turn on your radio for the first time, you must use the default password to unlock the radio. After successfully unlocking your radio with the default password, your radio prompts you to change the password to a new one.



**NOTE:** Change the default password to a new one. You can only proceed when the new password is confirmed. This feature is applicable to radios with Secure Hardware Encryption.

The new password must be different from the default password. Your service provider determines the following requirements:

- Number of characters for a password (maximum 10 characters).
- Number of attempts for password entry.

If you exhaust all attempts at entering the correct password, the radio is deadlocked. Restart the radio to start over.



**NOTE:** Depending on the configuration, the radio can carry over the number of attempts remaining even after a power cycle. If you exhaust all attempts in this configuration, the following occurs:

- The radio remains inhibited.
- All encryptions and secure keys are erased.

### 38.1

## Enabling or Disabling Radio Lock (Secure Radios Only)

### Procedure:

To enable or disable Radio Lock, press the **Logf** menu item.

### Result:

If the radio lock feature is enabled, the display shows `Pswd enabled`.

If the radio lock feature is disabled, the display shows `Pswd disabled`.

### 38.2

## Changing the Radio Lock Password

### Procedure:

1. Press the **Pswd** menu item.
2. Select **Unlock Pswd** and press **Sel**.
3. Enter the old password and press **OK**.
4. Enter the new password and press **OK**.

5. Reenter the new password and press **OK**.

**Result:**

The password is updated.

If the two passwords do not match, repeat [step 3](#) to [step 5](#).



**NOTE:** If you enter three incorrect old passwords, the radio exits the password feature. You cannot access this feature again until you turn the radio off and on.

### 38.3

## Changing the Tactical Inhibit Password

The Tactical Inhibit Password is required for the Radio Stun and Radio Kill features.

**Procedure:**

1. Press the **Pswd** menu item.
2. Select **Tactical Inh Encode Pswd** and press **Sel**.
3. Enter the old password and press **OK**.
4. Enter the new password and press **OK**.
5. Reenter the new password and press **OK**.

**Result:**

The password is updated.

If the two passwords do not match, repeat [step 3](#) to [step 5](#).



**NOTE:** If you enter three incorrect passwords, the radio exits the password feature. You cannot access this feature again until you turn the radio off and on.

## Chapter 39

# Radio Stun

This feature allows you to stun another radio by sending an Over-The-Air command using the menu on your radio. This feature prevents an unauthorized user from using the radio. Once the radio is stunned, a password is required to reactivate the stunned radio.

### 39.1

## Using Radio Stun

#### Procedure:

1. Press the **Stun** menu item.
2. Enter your Tactical Inhibit Encode password and press **OK**.
3. Perform one of the following actions:
  - Select the required ID.
  - To go to the last number dialed, press **LNum**.
  - Enter the required ID using the keypad.
4. To initiate the command, press **Send**.

#### Result:

If the receiving radio receives the command, the following indications occur:

- Your radio displays `Ack received`.
- The screen of the receiving radio locks and a password is requested.

If the receiving radio does not have encryption key to decrypt the received encrypted command, your radio displays `Dec fail`.

If the receiving radio is turned off or already killed, your radio displays `No Ack`.

## Chapter 40

# Radio Kill

This feature allows you to render your radio or another radio inoperable if the radio is misplaced or lost. When a radio is killed, the display turns blank, and all functions of the radio are not usable.

The killed radio can only be recovered with a special device. Consult an authorized and qualified technician for details.

### 40.1

## Using Remote Kill to Kill Another Radio

Remote Kill allows you to render another radio inoperable by sending an Over-The-Air command using the menu on your radio.

### Procedure:

1. Press the **Kill** menu item.
2. Enter your Tactical Inhibit Encode password and press **OK**.
3. Perform one of the following actions:
  - Select the required ID.
  - To go to the last number dialed, press **LNum**.
  - Enter the required ID using the keypad.
4. To initiate the command, press **Send**.

If the receiving radio receives the command, the following indications occur:

- Your radio displays `Ack received`.
- The screen of the receiving radio turns blank and the killed radio is inoperable.

If the receiving radio does not have encryption key to decrypt the received encrypted command, your radio display shows `Dec fail`.

If the receiving radio is turned off or already killed, your radio displays `No Ack`.

### 40.2

## Using Direct Kill to Kill Your Own Radio

Direct Kill allows you to make your own radio inoperable.

### Procedure:

1. Press and hold the **Accessory 2-Dot** button on the keypad microphone.
2. Press the **Orange** button until the display turns blank and becomes inoperable.

## Chapter 41

# Radio Inhibit

This feature allows the system administrator to put a radio into a nonfunctional state when the radio is missing or in an unknown hand. The radio stays in this state regardless of its power changes.



**NOTE:**

If the radio has Intersystem roaming capability, the system administrator is able to put the radio into a nonfunctional state when the missing radio roams to another system.

The radio can only be uninhibited by receiving an uninhibited command from the system administrator.



## Chapter 42

# Voice Announcement

This feature enables the radio to audibly indicate the current feature mode, zone, or channel assigned to the user.

The available voice announcement (VA) priority options are:

### High

Voice announcement is enabled even when the radio is receiving calls.

### Low

Voice announcement is disabled when the radio is receiving calls.



**NOTE:** If the **Voice Announcement** field is set to **Enabled**, after an interruption by a momentary tone one of the following scenarios occurs:

- If **Suppress Replay** field is **Enabled**, voice announcement replays.
- If **Suppress Replay** field is **Disabled**, voice announcement turns off.

## Chapter 43

# Site Selectable Alerts (ASTRO 25 Trunking)

A Site Selectable Alert (SSA) is an Intelligent Lighting indicator with audio alert. The alert is sent to radios at sites to notify the users when special situations occur.

Your radio supports up to 250 site aliases. Only authorized radios are enabled to send SSA.



**NOTE:**

The alert alias, alert tone, and alert period are configured in the Customer Programming Software (CPS). For more information, contact your system administrator.

The SSA alert volume is reduced when voice audio is received at the same time. It is important that the SSA audio file is created with clear loud audio to ensure audio clarity at reduced levels.

### 43.1

## Sending Site Selectable Alert Notifications

**Procedure:**

1. Press the **SSA** menu item.
2. Select **Start Alert** and press **Sel**.
3. Use one of the following options:

Option	Actions
Sending Site Selectable Alert (SSA) notifications to a single site	Select the required site alias and press <b>Sel</b> .
Sending SSA notifications to a single site using manual entry	<b>a.</b> Select <b>[SiteID Entry]</b> and press <b>Edit</b> . <b>b.</b> Enter the site ID and press <b>OK</b> .
Sending SSA notifications to all sites	Select <b>[All Sites]</b> and press <b>Sel</b> .
Sending SSA notifications to all available sites	Select <b>[All Avail]</b> and press <b>Sel</b> .

4. Select the required alert alias and press **Send**.
5. To return to the Home screen, press **Exit**.

**Result:**

If the request is successful, your radio displays a positive notification.

If one of the following situations occurs, your radio displays a negative notification.

- The site is not available.
- The site does not exist.
- The radio is out of range, roaming to a foreign system, or in a failsoft situation.

If you are at the site designated to receive this alert, your radio shows the following indications:

- The alert tone repeats periodically.

- The display shows the <Alert Alias> with intelligent lighting on the home screen.

## 43.2

## Stopping Site Selectable Alert Notifications

### Procedure:

1. Press the **SSA** menu item.
2. Select **Stop Alert** and press **Sel**.
3. Use one of the following options:

Option	Actions
Stopping Site Selectable Alert (SSA) notifications of a single site	Select the required site alias.
Stopping SSA notifications of a single site using manual entry	<ol style="list-style-type: none"> <li>a. Select <b>[SiteID Entry]</b> and press <b>Edit</b>.</li> <li>b. Enter the site ID.</li> </ol>
Stopping SSA notifications of all sites	Select <b>[All Sites]</b> .
Stopping SSA notifications of all available sites	Select <b>[All Avail]</b> .

4. Press **Send**.
5. To return to the Home screen, press **Exit**.

### Result:

If the request is successful, your radio displays a positive notification.

If one of the following situations occurs, your radio displays a negative notification:

- The site is not available.
- The site does not exist.
- The radio is out of range, roaming to a foreign system, or in a failsoft situation.

## Chapter 44

# Switching Between Repeater or Direct Operation Button

The Repeater Operation increases the radio coverage area by connecting with other radios through a repeater. The transmit and receive frequencies are different. The direct or talkaround operation allows you to bypass the repeater and connect directly to another radio. The transmit and receive frequencies are the same.

### Procedure:

To switch between talkaround and repeater mode, perform one of the following actions:

- Press the programmed **Repeater/Direct** button.
- Press the **Dir** menu item.

## Chapter 45

# Additional Performance Enhancement

The following performance enhancements are some of the latest creations designed to enhance the security, quality, and efficiency of the radios.

### 45.1

## ASTRO 25 Enhanced Data

ASTRO 25 Enhanced Data is optimized to handle different message sizes and variable update rates from different applications of the radio. To improve data channel efficiency and enable denser network traffic, add Enhanced Data to the Integrated Data system with a software installation.

### 45.2

## Dynamic System Resilience

Dynamic System Resilience (DSR) ensures that the radio system is seamlessly switched to a backup master site dynamically during a system failure. DSR also provides indications such as failure detection, fault recovery, and redundancy within the system. DSR also supports mechanisms related to the Integrated Voice and Data (IV&D), or data centric.

### 45.3

## CrossTalk Prevention

CrossTalk Prevention feature prevents crosstalk scenarios and allows the adjustment of the internal SSI clock rate of the radio. This reduces the possibility of radio frequency interfering spurs.

### 45.4

## Encrypted Integrated Data

Encrypted Integrated Data (EID) provides security encryption and authentication of Integrated Voice and Data (IV&D) bearer service. This bridges the communication between the radio and the Customer Enterprise Network.

### 45.5

## SecureNet

SecureNet allows you to perform secured communications on an Analog or Motorola Data Communication (MDC) channel. The MDC Over-the-Air Rekeying (OTAR) feature allows you to perform OTAR activities on an MDC channel.

### 45.6

## Over-the-Air Rekeying

The Over-the-Air Rekeying (OTAR) feature allows the dispatcher to remotely reprogram encryption keys in the radio after a rekey request.

### Single-system OTAR

This feature allows a radio to be rekeyed by only one Key Management Facility (KMF) or Key Management Controller (KMC).

### Multisystem OTAR

This feature allows a radio to be rekeyed by multiple KMFs. After an initial programming, the radio is able to seamlessly move to different secure systems associated to a newly selected channel.



**NOTE:** This feature must be programmed by a qualified radio technician. For more information, contact your system administrator.

## 45.7

# P25 Digital Vehicular Repeater System

Motorola Solutions offers an MSI Certified APX compatible, third party, P25 Digital Vehicular Repeater System (DVRS). This provides low-cost portable radio coverage in areas where only mobile radio coverage is available.

The system sends DVRS firmware and configuration updates over-the-air. The following scenarios occur during the update:

- If the update is accepted, the display shows `UPDATING DVRS`.
- If the update fails, the display shows `DVRS UPDT FAILED`. For more information, contact your system administrator.



**NOTE:** Portable subscriber units enabled in the system for Radio Authentication shall be able to authenticate regardless of whether they are communicating directly on the system or by using a DVRS.

DVRS can also work with SmartConnect to use broadband coverage for the in-vehicle mobile. Portable radios communicate through the in-vehicle mobile to the system through the LTE, Satellite, or Wi-Fi connection. This extends the system coverage when you are away from the vehicle.

### 45.7.1

## Accessing the DVRS

### Procedure:

Perform one of the following actions:

- To activate or deactivate the DVRS, press the programmed **DVRS** button.
- To access the DVRS menu display and control, press and hold the programmed **DVRS** button.



**NOTE:** You can change the button press type from the DVR configuration.

## 45.8

# Conventional Talkgroup and Radio Scan Enhancements

Enhancements have been made to the Conventional Talkgroup at the system to improve the Scan feature operation significantly when multiple agencies are using a single conventional radio frequency channel.

These enhancements allow you to use Selective Squelch to operate on only the subset of talkgroups that are relevant to the users rather than all talkgroups on the channel.

The enhancements support the following Scan mode:

- Mixed Vote Scan.

- Standard Conventional Scan.
- Priority Operation.

Up to 30 different talkgroups can be supported using conventional channels. A maximum of four talkgroups can be supported when Vote Scan channels are being used.

Smart PTT is supported with this enhancement as Smart PTT prevents you from transmitting while other users are on the channel.



**NOTE:** User Selectable Talkgroups are not compatible with this Conventional Talkgroup Enhancement.

## Chapter 46

# Accessories

Not all accessories are FCC certified to operate with all radio models, band splits, or both. See the radio price pages for a list of FCC certified accessories or contact your sales representative for accessory compatibility.

See <https://www.motorolasolutions.com> to know more about the accessories supported by this radio.



**NOTE:** GPS only antenna is used in either a single band UHF or 700/800 MHz application where the Public Safety Microphone (PSM) is used with the corresponding PSM antenna. This antenna is only for GPS reception and cannot be used for receive or transmit operation at UHF, VHF, or 700/800. Do not use this antenna on the PSM.