

Mobile Release 5.14.10



MTH800

PRODUCT INFORMATION MANUAL



March 2014



© 2014 Motorola Solutions, Inc. All rights reserved.



68015000886-F

Contents

List of Figures.....	7
List of Tables.....	9
Copyright Information.....	11
Service Information – EIA.....	13
Service Information – AME.....	15
Service Information – Americas.....	19
Icon Conventions.....	21
Chapter 1: Product Overview.....	23
MTH800 Overview.....	23
Specification.....	24
Ordering Options for Radios and Features.....	26
Dongle Enablement – Software Enablement Kits.....	26
Ordering a Software Enablement Kit.....	26
Radio Ordering.....	26
Golden Codeplug.....	27
Chapter 2: Services and Features.....	29
Features Overview.....	29
System Support.....	30
Trunked Mode Operation.....	31
Direct Mode Operation.....	31
Numbering and Addressing.....	32
Dialing Methods.....	32
Talkgroup Dialing.....	33
Individual Dialing.....	33
Unified Address Book.....	33
Call History.....	34
Group Call.....	34
Programmable Talkgroups.....	34
Talkgroup Folders.....	35
Talkgroup Selection.....	35
Favorite Folders.....	35
Talkgroup Blind Operation.....	36
Receive-only Talkgroups.....	36
Non-Selectable Talkgroups.....	36
Talk Time Limit.....	36
Group Call Reception.....	36
Talkgroup Scanning.....	36
Priority Monitor.....	37
Announcement Talkgroup.....	37
Broadcast Call Initiated by User.....	38
Timed Talkgroup Change.....	38
Broadcast Call.....	38
Announcement Call.....	39
PTT Double Push.....	39
PTT Queue.....	39
Talking Party Identification.....	39

Call Ownership.....	39
Transmission During Group Call.....	40
Call Restoration.....	40
Temporary Group Address.....	40
Late Entry.....	40
User Initiated Group Attachment.....	40
SwMI Initiated Group Attach/Detach.....	41
Private Call.....	41
Simplex Private Call.....	41
Duplex Private Call.....	41
Talk Time Limit.....	42
Call Restoration in Private Call.....	42
Call Modification.....	42
Assistance Call.....	42
DMO Individual Call Presence Check.....	42
DMO Individual Only Talkgroups.....	43
Phone Call.....	43
Phone Call Initiation.....	43
Phone Call Reception.....	43
Call Restoration in Phone Call.....	43
Emergency Operations.....	43
Emergency Group Call.....	44
Non-Tactical Emergency.....	44
Emergency Individual Calls (Private or MS-ISDN).....	44
Emergency Alarm.....	45
Emergency SDS Status.....	45
Emergency Hot Microphone.....	45
Alternating Hot Microphone.....	45
Silent Emergency Mode.....	46
Invisible Emergency.....	46
Disaster Alert.....	46
Short Data Services.....	47
Status Messages.....	47
Shadow Groups (Address Bundle).....	48
Text Messages.....	48
SDS Messages Concatenation.....	49
Immediate Text Messages.....	50
Home Display Text Message.....	50
Predefined Templates (ATS Entry Prompt).....	50
SDS Air Interface Aspects.....	50
SDS Encryption.....	50
SDS End-to-End Encryption.....	51
Store and Forward.....	52
Security Services.....	53
Terminal Equipment Identity.....	53
PIN/PUK User Authentication.....	53
Authentication.....	53
Air Interface Encryption.....	53
Clear Radios (Class 1).....	54
Static Cipher Key Encryption (Class 2).....	54
Derived Cipher Key and Common Cipher Keys Encryption (Class 3).....	54
Group Cipher Keys Encryption (Class 3G).....	55
Secure DMO.....	55
End-to-End Encryption.....	56
SIM Security.....	56
Radio Disable/Enable.....	57

Radio Permanent Disable.....	57
Radio Permanent Disable v2.....	58
High Assurance Boot.....	58
Packet Data.....	58
Voice and Data Support.....	59
Packet Data IP Addressing.....	60
PD User Authentication.....	61
TETRA Network Protocol 1.....	61
TNP1 IP Addressing.....	62
Mobility Services.....	62
Main Control Channel Frequencies.....	62
Control Channel Selection.....	62
Multi-System Operation.....	63
Registration.....	63
Call Roaming.....	64
Seamless Handover.....	65
Air Interface Migration.....	65
Dynamic Air Interface Migration.....	65
Any Networks.....	66
Congested Cell Handling.....	66
Subscriber Class.....	66
Subscriber Class by Talkgroup.....	66
Local Site Trunking.....	67
Supplementary Services.....	68
Dynamic Group Number Assignment.....	68
Ambience Listening.....	69
Pseudo Power-Off.....	69
Preemptive Priority Call.....	70
Transmit Inhibit Mode.....	70
Calling Line Identification Presentation.....	71
Talking Party Identification.....	71
DTMF Overdial.....	71
Universal Time Display.....	71
DMO Gateway and Repeater Communication.....	71
Communication through Repeaters.....	72
Communication through Gateways.....	72
SDS Remote Control.....	73
Call-Out.....	74
Call-Out Interactions.....	75
Radio Messaging System.....	75
GPS Location Service.....	76
GPS Military Grid Reference System.....	78
GPS Different Location Displays.....	79
WAP.....	79
WAP Browser.....	79
WAP Push.....	79
WAP Push Framework.....	80
WAP Push Service Indication.....	80
WAP Push Service Load.....	80
Radio User Assignment and Radio User Identity	80
RUA/RUI Log On	81
RUA/RUI Radio Behavior.....	81
RUA/RUI Interactions.....	81

Controls, Indicators and Related Features.....	83
LED Indications.....	83
Controls and Indicators.....	84
Keypad Lock.....	87
Automatic Keypad Lock.....	87
One-Touch Button Feature.....	87
Display.....	88
Status Icons.....	89
Idle Display.....	93
Configurable Idle Screen.....	94
Display Features.....	94
Languages Supported.....	94
Audio.....	95
Tones.....	95
Dual Microphones.....	97
Speaker/Earpiece.....	97
Volume Control.....	97
Volume Adjustment Mode.....	98
Accessory Setup.....	98
Man-Machine Interface Testing.....	98
Test Page.....	98
Radio Info.....	99
Hardware Test.....	100

Appendix A: Glossary..... 101

List of Figures

Figure 1: MTH800 Portable	23
Figure 2: Trunked Mode Operation	31
Figure 3: Direct Mode Operation	32
Figure 4: Talkgroup Tree	35
Figure 5: SDS End-to-End Encryption	52
Figure 6: Voice and Data End to End Encryption	56
Figure 7: SDS remote Control Overview	73
Figure 8: Radio Messaging System Flow Model	75
Figure 9: Push Framework	80

List of Tables

Table 1: Service Information — Telephone Numbers to EIA Integrated Call Center	13
Table 2: Service Information — Telephone Numbers and Addresses of the Asia and Pacific Motorola Centers	15
Table 3: Service Information — Telephone Numbers and Addresses of Latin America Radio Support Centers	19
Table 4: Service Information — Telephone Numbers and Addresses of Latin America Motorola Centers	19
Table 5: General Technical Specification	24
Table 6: RF Specification	25
Table 7: GPS Specification	25
Table 8: Dialing Scheme	33
Table 9: Security Features Required Per Security Class	54
Table 10: Voice-Data Interaction Modes	59
Table 11: Packet Data IP Addressing	60
Table 12: TNP1 IP Addressing	62
Table 13: GPS Triggers	77
Table 14: Different Location Displays	79
Table 15: LED Indications	83
Table 16: Controls and Indicators	85
Table 17: One-Touch Button Features	87
Table 18: Display	89
Table 19: Colors of the Soft Key Area	89
Table 20: Status Icons	90
Table 21: Languages Supported	94
Table 22: Radio Tones	95
Table 23: Speaker Control Key Behavior	97

Copyright Information

The Motorola products described in this manual may include copyrighted Motorola computer programs stored in semiconductor memories or other mediums. Laws in the United States and other countries preserve for Motorola certain exclusive rights for copyrighted computer programs, but not limited to, including the exclusive right to copy or reproduce in any form the copyrighted computer program. Accordingly, any copyrighted Motorola computer programs contained in the Motorola products described in this manual may not be copied, reproduced, modified, reverse engineered, or distributed in any manner without the express written permission of Motorola.

© 2013 Motorola Solutions Inc. All rights reserved.

No part of this manual may be reproduced, transmitted, stored in a retrieval system, or translated into any language or computer language, in any form or by any means, without the prior written permission of Motorola Solutions, Inc.

Furthermore, the purchase of Motorola products shall not be deemed to grant either directly or by implication, estoppel, or otherwise, any license under the copyrights, patents, or patent applications of Motorola, except for the normal non-exclusive license to use that arises by operation of the law in the sale of a product.

Service Information – EIA

Service orders are dealt with by two centres: European Radio Support Centre (ERSC) and European Systems and Components Centre (ESCC). This section contains contact details to service centers in Europe, Middle East, and Africa.

European Radio Support Centre (ERSC)

ERSC provides a remote Technical Support Service to help customers resolve technical issues and quickly restore their systems. The centre handles service orders for subscribers and accessories. This team of highly skilled professionals is available to the customers that have current ERSC service agreements in place. For further information and to verify whether your current service agreement entitles you to benefit from this service, contact your local customer support.

To contact ERSC, use the following EIA Integrated Call Center details:

E-mail: ersc@motorolasolutions.com .

Telephone: +49 30 66 86 1555

European Systems and Components Centre (ESCC)

ESCC provides a repair service for infrastructure equipment. Customers requiring a repair service should contact the Customer Information Desk and obtain a Return Material Authorization number. Unless advised otherwise, the equipment should then be shipped to the following address:

Motorola GmbH, European Systems Component Center, Am Borsigturm 130, 13507 Berlin, Germany

E-mail: escc.admin@motorolasolutions.com.

Telephone: +49 30 66 86 1404

Mon – Fri, 08:00 am – 06:00 pm (CET)

Table 1: Service Information — Telephone Numbers to EIA Integrated Call Center

Country	Telephone Number
Austria	1206091087
Denmark	43682114
France	157323434
Germany	6950070204
Italy	291483230
Lithuania	880030828
Netherlands	202061404
Norway	24159815
Portugal	800552277
Russia	810800228 41044 (Alternative 8108001201011)
Saudi Arabia	8008445345
South Africa	0800981900
Spain	912754787

Table continued...

Country	Telephone Number
United Kingdom	2030277499
Other Countries	+42 0533336946

Parts Identification and Ordering

To get help in identification of non-referenced spare parts, contact your local Motorola Customer Care Organization.

To request replacement parts, kits and assemblies, place orders directly through your Motorola local distribution organization or through <http://emeaonline.motorolasolutions.com>.

EIA Test Equipment Support

For information related to support and service of Motorola Test Equipment, contact your local Motorola Customer Care Organization or see <http://emeaonline.motorolasolutions.com>.

For customers in Germany, contact the Equipment Service Group in Germany:

Telephone: +49 (0) 6128 702179

Fax: +49 (0) 6128 951046

Latest Versions of Manuals

To download the latest versions of technical manuals, see <http://emeaonline.motorolasolutions.com>.

Submit Your Comments

If you have any comments or would like to report a problem regarding Motorola publications, send an e-mail to: esc.admin@motorolasolutions.com.

Service Information – AME

This topic contains contact details to service centers in the Asia and Pacific region.

Technical Support

Technical support is available to assist the dealer/distributor in resolving any malfunction which may be encountered. Initial contact should be by telephone wherever possible. When contacting Motorola Technical Support, be prepared to provide the product model number and the serial number.

Further Assistance from Motorola

You can also contact the Customer Help Desk through the website: <http://www.motorolasolutions.com/tetra>. If a unit requires further complete testing, knowledge and/or details of component level troubleshooting or service than is customarily performed at the basic level, send the radio to a Motorola Service Center as listed in the following table:

Table 2: Service Information — Telephone Numbers and Addresses of the Asia and Pacific Motorola Centers

Country	Telephone Number	Address
Singapore	+65-6352-6383	Motorola Solutions Singapore Pte. Ltd, c/o Azure Engineering, 49 Jalan Pemimpin, #03-11 APS Industrial Building, Singapore 577203 Contact: Mareen Phua E-mail: mareen@azure.com.sg Enquiry: Tay Yong Hock E-mail: yonghock.tay@motorolasolutions.com
Malaysia	+603-7809-0000	Motorola Solutions Sdn. Bhd. Level 14, Persoft Tower, No. 68, Pesiaran Tropicana, 47410 Petaling Jaya, Selangor Darul Ehsan, Malaysia Contact: Koh Tiong Eng E-mail: A21001@motorolasolutions.com
Indonesia	+62-21-3043-5239	PT. Motorola Solutions Indonesia 30th Floor, Gedung BRI II, Suite 3001, Jl. Jend. Sudirman Kav. 44-46, Jakarta 10210, Indonesia Contact: Eko Haryanto E-mail: Eko.Haryanto@motorolasolutions.com
Thailand	Tel: +662-653-220 Fax: +668-254-5922	Motorola Solutions (Thailand) Ltd. 142 Two Pacific Place Suite 2201,

Table continued...

3220 Sukhumvit Road,
Klongtoey,
Bangkok 10110
Contact: Nitas Vatanasupapon
E-mail: Nitas@motorolasolutions.com

India	+91-9844218850	<p>Motorola Solutions India Pvt. Ltd. C/o Communication Test Design India Private Limited, #4, 5 Maruthi Industrial Estate, Rajapalya, Hoodi Village, Bangalore - 560048, India Contact: K. Umamaheswari E-mail: umamaheshwari@motorolasolutions.com</p>
China	+86-10-8473-5128	<p>Motorola Solutions (China) Co. Ltd. No. 1 Wang Jing East Road, Chao Yang District, Beijing, 100102, P.R. China Contact: Sophy Wang E-mail: C18170@motorolasolutions.com</p>
(Hong Kong)	852-2966-4823	<p>Motorola Solutions Asia Pacific Ltd. Unit 1807-1812, 18/F, Two Harbourfront, 22 Tak Fung Street, Hungghom, Kowloon, Hong Kong Contact: Judy Leung E-mail: Judy.Leung@motorolasolutions.com</p>
Philippines	Tel: +632 858-7500 Fax: +632 841-0681	<p>Motorola Communications Philippines, Inc. Unit 2102, One Global Place Building, 5th Ave., Bonifacio Global City, Taguig, Philippines 1634. Contact: Arthur Nieves E-mail: Arthur.Nieves@motorolasolutions.com</p>
Korea	+822-3497-3649	<p>Motorola Solutions Korea, Inc. 9th Floor, Hibrand Building, 215, Yangjae-Dong, Seocho-Gu, Seoul, 137-924, Korea. Contact: KS Kwak E-mail: r45321@motorolasolutions.com</p>
Taiwan	+886-2-8729 8000	<p>Motorola Solutions Taiwan, Ltd. 8F, No. 9, Songgao Rd., Taipei 110,</p>

Table continued...

Taiwan (R.O.C.)
 Contact: Michael Chou
 E-mail: fmpe239@motorolasolutions.com

Australia +613-9847-7725

Motorola Solutions Australia Pty. Ltd.
 10 Wesley Court,
 Tally Ho Business Park,
 East Burwood Victoria 3151,
 Australia.
 E-mail: servicecentre.au@motorolasolutions.com

Piece Parts

Some replacement parts, spare parts, and/or product information can be ordered directly. If a complete Motorola part number is assigned to the part, it is available from Motorola Radio Aftermarket and Accessory Division (AAD). If no part number is assigned, the part is not normally available from Motorola. If a list of parts is not included, that means that no user-serviceable parts are available for that kit or assembly.

Customer Programming Software has no capability to tune the radio. Tuning the radio can only be performed at the factory or at the appropriate Motorola Repair Center. Component replacement can affect the radio tuning and must only be performed by the appropriate Motorola Repair Center.

All orders for parts/information should include the complete Motorola identification number. All part orders should be directed to your local AAD office. See your latest price pages.

Parts Identification and Ordering

Request for help in identification of non-referenced spare parts should be directed to the Customer Care Organization of Motorola local area representation. Orders for replacement parts, kits, and assemblies should be placed directly on Motorola local distribution organization or via Motorola Online (Extranet).

Service Information – Americas

This topic contains contact details to service centers in Latin America and Caribbean region.

Technical Support

To request technical support, go to <https://businessonline.motorolasolutions.com>, **Contact Us**.

Some replacement parts, spare parts, and/or product information can be ordered directly. If a complete Motorola part number is assigned to the part, it is available from Motorola. If no part number is assigned, the part is not normally available from Motorola. If the part number is appended with an asterisk, the part is serviceable by Motorola Depot only. If a list of parts is not included, that means that no user-serviceable parts are available for that kit or assembly.

Warranty and Repairs

Table 3: Service Information — Telephone Numbers and Addresses of Latin America Radio Support Centers

Country	Telephone Number	Address
Colombia	571- 376-6990	MOTOROLA DE COLOMBIA SERVICE CENTRE Torre Banco Ganadero Carrera 7 No. 71-52 Torre B piso 13 Oficina 1301 Bogota
Mexico	5252576700	MOTOROLA DE MEXICO SERVICE CENTRE Bosques de Alisos #125 Col. Bosques de las Lomas CP 05120 Mexico DF

Piece Parts

To order parts in Latin America and the Caribbean contact your local Motorola CGISS representative.

Table 4: Service Information — Telephone Numbers and Addresses of Latin America Motorola Centers

Country	Telephone Number	Address
Argentina	5411-4317-5300	MOTOROLA DE ARGENTINA Ave. del Libertador 1855 B1638BGE, Vicente Lopez Buenos Aires
Brasil	5511-3847-668	MOTOROLA DO BRASIL LTDA. Av. Chedid Jafet 222 Bloco D Conjuntos 11,12,21,22 E 41 Condominio Millennium Office Park 04551-065- Vila Olimpia, Sao Paulo

Table continued...

Country	Telephone Number	Address
Chile	562-338-9000	MOTOROLA CHILE Ave. Nueva Tajamar 481 Edif. World Trade Center Of. 1702, Torre Norte Las Condes Santiago
Colombia	571-376-6990	MOTOROLA DE COLOMBIA, LTDA. Carrera 7 #71-52 Torre A, Oficina 1301 Bogotá
Costa Rica	506-201-1480	MOTOROLA DE COSTA RICA Parque Empresarial Plaza Roble Edificio El Portico, 1er Piso Centro de Negocios Internacional Guachepelin, Escazu San Jose
Ecuador	5932-264-1627	MOTOROLA DEL ECUADOR Autopist Gral. Rumiñahui, Puente 2 Conjunto Puerta del Sol Este-Ciudad Jardin Pasa E, Casa 65 Quito
Mexico	52-555-257-6700	MOTOROLA DE MEXICO, S.A. Calle Bosques de Alisos #125 Col. Bosques de Las Lomas 05120 México D.F.
Peru	511-211-0700	MOTOROLA DEL PERU, S.A. Ave. República de Panama 3535 Piso 11, San Isidro Lima 27
USA	954-723-8959	MOTOROLA SOLUTIONS, INC. Latin American Countries Region 789 International Parkway Sunrise, FL 33325
Venezuela	58212-901-4600	MOTOROLA DE LOS ANDES C.A. Ave. Francisco de Miranda Centro Lido, Torre A Piso 15, El Rosal Caracas, 1060

Icon Conventions

The following graphic icons, which help identify situations or settings crucial to proper radio operation and user safety, are used throughout this document:



Danger: The signal word DANGER with the associated safety icon indicates information that, if disregarded, will result in death or serious injury.



Warning: The signal word WARNING with the associated safety icon indicates information that, if disregarded, could result in death or serious injury, or serious product damage.



Caution: The signal word CAUTION with the associated safety icon indicates information that, if disregarded, may result in minor or moderate injury, or serious product damage.

Caution: The signal word CAUTION may be used without the safety icon to state potential damage or injury that is not related to the product.



Important: IMPORTANT statements contain information that is crucial to the discussion at hand, but is not CAUTION or WARNING. There is no warning level associated with the IMPORTANT statement.



Note: NOTE contains information more important than the surrounding text, such as exceptions or preconditions. They also refer the reader elsewhere for additional information, remind the reader how to complete an action (when it is not part of the current procedure, for instance), or tell the reader where something is located on the screen. There is no warning level associated with a note.



Suggestion: SUGGESTION indicates a recommendation from Motorola that does not require to be followed, but might be helpful. There is no warning level associated with SUGGESTION.

Chapter 1

Product Overview

MTH800 Overview

Motorola MTH800 is a compact yet robust radio. Thanks to its form factor and rubber features, provides a comfortable and user-friendly tool you can depend on even in the toughest environments.

Figure 1: MTH800 Portable



The MTH800 features an extensive set of tools designed to enhance the personal safety, security, and efficiency of both mission-critical and commercial users. Incorporating the latest technologies, it includes support for GPS Location Services, high-grade encryption, data services and much more – enhancing user safety and driving efficiencies.

Ensuring full customer flexibility, two GPS protocols are supported, including the TETRA Location Information Protocol (LIP), allowing users to:

- Control and reconfigure GPS parameters over-the-air.
- Define location and event driven position updates.
- Set profiles to enable different location update rules in various scenarios, such as emergency situations.
- Ensure that location information is only sent to authorized users through innovative authentication processes.

Compact and lightweight, the MTH800 advanced microprocessor and Digital Signaling Processor (DSP) support Motorola TETRA innovations including WAP, Multi-Slot Packet Data, Short Data Service (SDS), and Predictive Text Entry (iTAP). Full End-to-End encryption as well as TEA1, TEA2, or TEA3 air encryption may either be factory fitted, provisioned in-country or, alternatively, retro-fitted at a later date.

Furthermore, the MTH800 65536–color, 130 by 130–pixel display provides accurate reproduction of faces and other images. This high quality delivers maximum image definition in a wide range of lighting conditions. An intuitive graphical user interface complements the high-resolution display. The interface encompasses a range of customizable features, including scalable fonts, assignable shortcuts to menu items and features. It also provides access up to 4000 talkgroups and a unified address book facility that can hold 2000 entries. User safety is further enhanced with the large, easy to use the emergency button, as well as the programmable rotary knob. The rotary knob with the push-button operation allows fast access to volume and talkgroup control. The 1 Watt speaker assures audio quality, as well as a 1 Watt class D audio amplifier, which combines to offer exceptional audio clarity with minimal distortion. Two microphones are also included – a top microphone for dispatcher calls, and a bottom microphone for one-to-one calls.

Specification

Table 5: General Technical Specification

Parameter	Value	
Dimensions HxWxD mm	141 x 55 x 33 (with standard 800 mAh battery) 141 x 55 x 38 (with Extended 1500 mAh battery)	
Weight g	192 radio only 222 with 800 mAh battery 247 with 1500 mAh battery	
Battery Operating Life (Time Expected)	800 mAh	1500 mAh
05/05/90	> 12 hr	> 20 hr
05/35/60	> 8 hr	> 16 hr
Talkgroups - TMO	4000 Entries (up to 2048 entries in one folder) 2048 Unique entries	
Talkgroups - DMO	1024 Entries	
Folders - TMO	256	
Folders - DMO	128	
Favorite Groups	384 (3 Favorite Groups folders containing up to 128 entries each)	
Contact List	1000 Contacts up to six entries (numbers) per contact Max. 2000 entries	
Text Message List	100 Short and 20 Long Messages for Outbox 100 Short and 10 Long Messages for Inbox	
Status List	400 Entries	
Country Code/Network Code List	100 Entries	
Scan List	40 Lists of 20 Groups	
Operating Temperature °C	-30 to +60	
Storage Temperature °C	-40 to +85	
Humidity	90% to 95% RH @ +50 °C for 8 hours	

Table continued...

Parameter	Value
Rain	IPx4 - EN60529 (former IEC 529 class)
Dust	IP5x (cat.2) - EN60529 (former IEC 529 class)
Salt Fog	8 hr exposure to 5% saline solution at 35 °C
Shock (Mechanical), Drop & Vibration	ETS 300 019-1-7 5M3 (Shock: Type I, 18 shocks total)
Thermal Shock °C	-40 to +80 (Battery: -20 to +60)

Table 6: RF Specification

Parameter	Value
Frequency Bands MHz	380–430 MHz 440–470 MHz
RF Channel Bandwidth kHz	25
Switching Bandwidth TMO MHz	50 (380–430 MHz) 20 (440–470 MHz)
Switching Bandwidth DMO MHz	50 (380–430 MHz) 20 (440–470 MHz)
Transmitter/Receiver Separation MHz	10
Transmitter RF Output Power W	1
RF Power Control	3 Steps of 5 dB
RF Power Level Accuracy +/-dB	2
Receiver Class	A and B
Receiver Static Sensitivity dBm	-112 minimum (-116 typical)
Receiver Dynamic Sensitivity dBm	-103 minimum (-105 typical)

Table 7: GPS Specification

Parameter	Value
Simultaneous Satellites	12
Mode of Operation	Autonomous or Assisted (A-GPS)
GPS Antenna	Helical - integrated into TETRA Antenna
Sensitivity	-152 dBm / -182 dBW
Accuracy (Measured at -137 dBm)	5 meters - 50% probable 10 meters - 95% probable



Note: This specification may be subject to change without further notice. All product features are subject to infrastructure support. Selected features are subject to optional software upgrade.

Ordering Options for Radios and Features

TETRA terminals are only available to accredited channel partners who are advised of the discount structure applied to these products.

Software options can be ordered and enabled in three ways:

- You can have them enabled at the Distribution Centre (DC).
- If you have iTM, you can enable them with a license.
- You can order by using dongle.

Dongle Enablement – Software Enablement Kits

Each software enablement kit ordered provides one dongle for the customer with a specific number of counters set according to the number of software options ordered. This kit number is applicable to both new orders or existing fielded terminals which require software enablement.

The features are enabled at the same time the customer programs the radio. The enablement for all the selected features is performed in one operation.

Ordering a Software Enablement Kit

Procedure:

- 1 Order the standard software enablement kit (main kit) – GM0127.
- 2 Add software feature options.



Note: You can select more than one feature for each main kit.

- 3 Order a quantity equaling the number of models requiring an option.

Radio Ordering

Procedure:

- 1 Order the main radio model.
- 2 Order options from each of the following categories:
 - Software Selling Features
 - Customer Programming Software
 - Integrated Terminal Management
 - Accessories



Note: Export controls apply when ordering encryption.

Golden Codeplug

The Golden Codeplug covers all standard codeplug fields and required optimal settings. In a Golden Codeplug, field parameters are pre-configured and fine-tuned for high quality and to get better performance from your new radio.

Chapter 2

Services and Features

Features Overview

Trunk Mode Operation (TMO)

- Air Interface Encryption - SCK, CCK, DCK, GCK
- Air Interface Migration
- Ambience Listening
- Announced Type 2 handover
- AT commands
- Broadcast Call
- Call-Out
- Congested Cell Handling
- DGNA (Individually and group addressed)
- Duplex private call
- Dynamic Key Encryption
- Emergency group call
- Group call
- Hot Mic and Alternating Hot Mic
- Multi-Network Operation
- Mutual Authentication
- OTAR (Over The Air Re-keying)
- Packet Data (Multi-Slot)
- Preemptive Priority Call
- PTT Double Push
- Radio Messaging System
- RUA/RUI
- SDS Remote Control
- SDS Store and Forward
- Secondary Control Channel
- Short Data Services (Status, Text Message)
- Simplex private call
- SwMI Initiated Authentication
- Talkgroup and Priority monitor
- Targeted SDS Status (to SSI)
- Telephone call (PSTN/PABX)
- Temporary/Permanently Enable/Disable
- TNP1
- Transmit Inhibit (RF Sensitive Area Mode)

Direct Mode Operation (DMO)

- AT commands
- DMO Group Call
- DMO Group Emergency Call
- DMO Inter-MNI (including open group and open MNI)
- DMO Private Call – Simplex Only
- DMO Repeater Capability
- DMO Static Key Encryption (DMO SCK)
- DMO/TMO Emergency Switching
- PTT Double Push
- Short Data Services (Status, Text Message)
- Targeted SDS Status (to SSI)
- Transmit Inhibit (RF Sensitive Area Mode)

Platform Specific Features

- 4-way navigation key
- Built-in GPS receiver
- Dual-function rotary (volume, list selection) with the push button
- Energy Economy
- Flashing via USB
- GPS over Multi-Slot Packet Data
- GPS over SDS
- High-resolution color display

General Features

- Covert Mode
- Favorite talkgroups
- Flexible size talkgroup folders
- GPS location reports and display
- High Assurance Boot (HAB) memory access protection
- Super groups of scan groups

Features Not Supported in Dimetra

- Background scanning
- Call modifications
- CCK per LA
- DCK Forwarding
- Emergency Private call
- SDS via PSTN Gateway (SDS to PABX is not possible)
- SwMI controlled groups
- SwMI initiated attachments

System Support

The radio operates on the Dimetra IP 5.x, 6.x, 7.x and 8.x releases and Dimetra IP Compact. It also operates on previous versions of Dimetra — from Release 3.8 and on.

The radio is designed to operate optimally on the Dimetra IP system. The radio operates properly on all SwMIs that comply with the following IOP TIP documents:

- TIP-Core TTR 001-01, TIP — Part 1: Core.
- TIP SDS TTR 001-02, TIP — Part 2: Short Data Service.
- TIP Auth TTR 001-04 TIP — Part 4: Authentication.
- TIP PD TTR 001-05 TIP — Part 5: Packet Data.
- TIP-SS-AL TTR 001-09 TIP — Part 9: Ambience Listening.
- TIP AIE TTR 001-11 TIP — Part 11: Air Interface Encryption.
- TIP Disable TTR 001-13 TIP — Part 13 - Enable/Disable.

Trunked Mode Operation

Trunked Mode Operation requires the switching and management infrastructure. This operation mode enables various voice and data communication types (for example, group calls, short data service messages) and access to the infrastructure-related features (for example, packet data).

Figure 2: Trunked Mode Operation

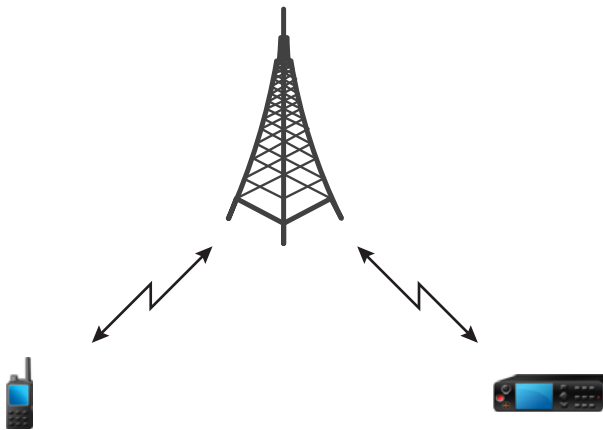

Direct Mode Operation

Direct Mode Operation is a mode of simplex operation where radios communicate directly.

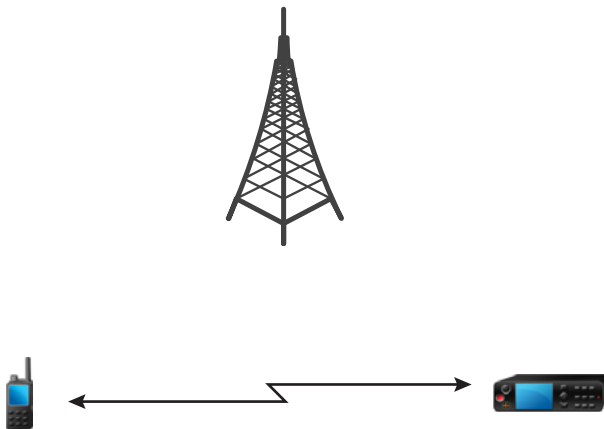
Figure 3: Direct Mode Operation

Numbering and Addressing

Each radio has a TETRA ITSI used for addressing the radio over the air interface. However, it is undesirable to require you to enter a long number to address another radio. To this end, a set of short number schemes can be used.

Alternatively, the radio can be provisioned to treat a short number as an SSI. This scheme can be refined to allow short dialing within a fleet by combining the ID entered with the radio own SSI.

If the radio is provisioned to treat a short number as a TETRA Short Subscriber Identity (SSI), and the number entered is less than seven digits, the radio own identity is combined with the number entered to produce the actual ISSI. Using this scheme, an ISSI can be comprised of a fleet number part and a member part.

The radio own ISSI is used for determining the leading digits for the digits omitted as in the following scenario:

- 1 The radio has the following ID: 1234567
- 2 You enter: 890
- 3 The SSI sent is: 1234890

The following services can use the short SSI for identification for both the called and the calling party:

- Duplex private call
- Simplex private call
- Group call
- Mobile status
- Short data bearer service
- Text message service

Regardless of the short addressing scheme used, if you are provisioned with the capability of entering a real TETRA ISSI and you enter an ID of seven digits, the number is interpreted as a real TETRA ISSI.

Dialing Methods

The radio supports multiple methods for selecting a number for an outgoing call.

The direct dialing method provides the radio user with an option to dial a number before entering the mode (modeless operation for all types of calls). To start dialing from the idle display, activate the private number dialing editor by pressing and holding an assigned key. The default call type is suggested with the option to change the call type.

Scrolling keys are used to scroll back and forth through the contact list or talkgroup/folder names.

Talkgroup Dialing

Talkgroup dialing by index allows calling from a radio to a talkgroup by using the talkgroup speed dial number (in other words the Talkgroup ID or Index). By default, scroll through a list of talkgroups to find the one and call. With the talkgroup dialing by index option enabled, you can use the keypad and enter the talkgroup speed dial number followed by the * key. For example, to call a talkgroup whose ID is 19, enter 1, 9, and * from the keypad and then select 'Attach' soft key when viewing the offered talkgroup information. To start the group call, press the PTT button.

Individual Dialing

If the One-Touch Button method is provisioned, you can call an individual by pressing and holding down one of the programmable buttons.

The Phone/PABX feature allows you to dial Phone/PABX by a shortened number of up to three digits instead of the full number. The Phone/PABX Speed # number is assigned when the dialed number is added in the contact list.

You can re-dial numbers from the call history stack.

The private ID number is a number with up to 16 digits. If you enter less than 16 digits, the Individual Short Subscriber Identity (ISSI) part is padded to full Individual TETRA Subscriber Identity (ITSI) with leading zeros. The private ID number consists of MCC (Mobile Country Code), MNC (Mobile Network Code) and ISSI.

Table 8: Dialing Scheme

MCC	MNC	ISSI
16–14	13–9	8–1



Note: For the MNC of a private ID (digits 13-9) values from 00000 to 16383 are accepted.

Two options are given to the user:

- Fixed: Provides up to 16 digits which include the MCC, MNC, and ISSI numbers. If you enter less than 16 digits, then the rest is filled with the digits that are set in the codeplug.
- Automatic: Provides up to eight digits. If you provide more, it switches to fixed mode. If you enter less than 16 digits, the radio fills the rest of the number with its own ITSI.

If you try to enter more than 16 digits, you receive a prompt informing about an incorrect input.

Unified Address Book

The radio offers an address book facility, where multiple numbers are associated with a single name tag. This facility presents an interface to the address book and provides a natural way to call an individual who can be contacted in different ways.

Each individual can have up to six associated numbers:

- Private (a TETRA ISSI)
- Home (phone number)
- Mobile (phone number)
- Work (phone number)

- PABX (local short number)
- Other (phone number)

The Contact List has a maximum capacity of 2000 Contacts, with up to 1000 associated Private and up to 1000 associated either Phone or PABX numbers distributed among the contacts.

The radio provides editing capabilities to the address book to allow adding or deleting entries.

The radio provides with the possibility to view the number of used and free address book entries.

The address book is also accessible through PEI. Using the PEI enables you to read, write, and modify contact list entries using AT commands.

Call History

A call history stack is provided which consists of the following:

- Last dialed numbers
- Missed call numbers
- Answered (Received) call numbers

Additionally for the recent calls the time when a call was established and the call duration is available.

The Call History stack holds private TETRA IDs as well as phone and PABX numbers.

Numbers from the stack may be viewed, selected, and called. However, outgoing duplex calls from Recent Calls list display in DMO are not allowed. When you scroll through the lists, the entries appear in the opposite order (the most recent entry is shown first).

When a call is made to a number that exists in the last dialed list, this number is not duplicated in the list and is moved to the beginning of the list. However, a missed call and received entries are duplicated in the corresponding call list.

The call history lists are available after next power-up.

You can save a number from the call history stack to the address book.

Group Call

The group call service enables the radio to communicate with a group of other TETRA radios using point to multi-point operation. This service is available in both TMO and DMO. You can initiate a new group call to the selected talkgroup or talk back to the existing group call by pressing the PTT button.

Programmable Talkgroups

The radio offers a talkgroup list facility. Each talkgroup entry contains a TETRA group address and may be associated with a name tag. The talkgroups can be defined in the codeplug as per the radio capabilities. Talkgroups are configured separately for TMO and DMO modes. To program a talkgroup in TMO define its name and GSSI. To program a talkgroup in DMO define its name, GTSI and frequency. The radio operator can select a talkgroup which has an associated TMO or DMO frequency depending on the mode selected. When switching between the TMO and DMO modes the last active talkgroup is selected. However the required talkgroup can be mapped in CPS. In such a case a corresponding talkgroup is automatically selected during mode switching, irregardless of the previously selected talkgroup.



Note: Neither the group name nor the corresponding group address can be edited using the radio MMI.

Talkgroup Folders

The talkgroups are organized in folders. You can select a talkgroup by first choosing a folder and then the talkgroup in the folder. Use the rotary knob or the Option button to select the talkgroup, for detail procedure see the *Feature User Guide*. The size of each folder is flexible and can be defined through provisioning.

The talkgroup folders are organized in a tree-structure:

- Level 1 Folders
 - Placed at the root of the folder structure.
 - Can contain both level 2 folders and talkgroups at the same time.
 - Can contain any number of level 2 folders.
- Level 2 Folders
 - Placed in level 1 folders.
 - Any given level 2 folder can only be subfolder to one level 1 folder.
- Level 3 Folders
 - Placed in level 2 folders.
 - Any given level 3 folder can only be subfolder to level 2 folder.

Figure 4: Talkgroup Tree

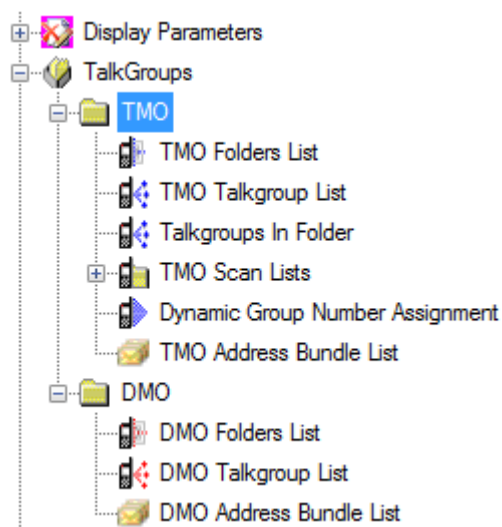

Note: The folder definitions cannot be changed using the radio MMI. Any talkgroup folder or subfolder which is either empty or does not contain any programmed talkgroups is hidden in the MMI.

Talkgroup Selection

Talkgroup selection from the stored talkgroups list in the idle mode can be performed by scrolling through the list using the scroll keys, or the rotary knob.

Talkgroup scrolling can be provisioned to scroll in a folder only, or continuously through the folders acting as one continuous list of groups.

The radio does not allow directly dialing a group SSI.

Favorite Folders

You can add frequently used talkgroups and phone book contacts to the Favorite folder. You can add items from Favorites or Talkgroups and Contacts menu levels respectively.

This feature allows a quick access to frequently used talkgroups by including the groups in up to three favorite talkgroups ranges. These ranges are separately stored in the data storage.

The feature operates in both TMO and DMO modes. The favorite talkgroups ranges are shared for TMO and DMO talkgroups. You can select, view, and edit **My Groups** ranges. Once a group from the **My Groups** range is selected, you can select any of the favorite talkgroups in that range using normal procedure.

A favorite talkgroup range name replaces a talkgroup range name on the radio display whenever a favorite talkgroup is selected, or is in use for appropriate operation. The ranges of favorite talkgroups with their talkgroup assignments are kept through the radio power cycle.

Talkgroup Blind Operation

The radio can be provisioned with a virtual rotary end-stop option for use in blind operation. When you have scrolled to the beginning or the end of the list, the first or the last talkgroup is displayed even if you continue to scroll. A tone is emitted when the upper or lower virtual end stop is reached. To change this setting for the rotary knob you can select “Wrap around Rotary Knob Group Scrolling” option in the CPS.

Receive-only Talkgroups

Talkgroups can be provisioned as receive-only talkgroups. This setting depends on the settings of the folder the talkgroup is in. Any talkgroup from the receive-only folder can be selected. The radio allows to receive calls, however, no call can be initiated to this talkgroup.

Non-Selectable Talkgroups

A talkgroup can be provisioned as a non-selectable talkgroup. Such talkgroups are not visible when scrolling through the talkgroup list, and thus cannot be selected. The group name is displayed only upon receiving a call for the group, for instance, if it is an announcement talkgroup associated with the selected group, or if it is a scanned one. The radio user is not allowed to edit the scan list.

Talk Time Limit

The radio limits the time you can continuously talk in a group call without interruption, according to a provisioned value. You are warned a short time before the talk time expires. The timer is provisioned per talkgroup folder.

Group Call Reception

In most situations, the radio receives group calls without any intervention. When the radio receives an incoming group call, you may be alerted with a short alert tone. Depending on the configuration the tone may be disabled. Then the speech follows.

To clear a call ended by the call owner (normally the SwMI), you do not need to do anything. However, you can leave a group call. Then the call continues for other radios, however, your radio does not participate in the call anymore.

Talkgroup Scanning

Talkgroup scanning allows the radio to monitor signaling of a number of talkgroups at the same time. In addition to monitoring signaling addressed to the selected talkgroup, the radio can monitor signaling addressed to multiple talkgroups.

To use the multiple group monitoring, define a scan list — the user-activated scan list. This list holds up to 20 talkgroups, which you monitor in addition to the selected group.

You can choose only one user-activated scan list at a time. When this list is activated, the radio begins to monitor traffic for these groups in addition to the traffic for the selected group. The radio can allow creating and editing the scan list using MMI. Up to 40 scan lists can be defined.

If the SwMI instructs a radio to detach one of the scanned groups, the radio stops monitoring the group, but the group remains in the scan list. Subsequent attachment of a group by the SwMI causes the radio to begin monitoring the group again.

The SwMI may also instruct a radio to attach groups from out of the scan list. If the group attachment is accepted, the radio monitors the group.

The radio may passively monitor the following talkgroups if they have been attached or are always attached:

- Selected talkgroup.
- ATG associated with the selected talkgroup (if this talkgroup is not set as **Permanently detach**).
- Talkgroups associated with the selected ATG (if this talkgroup is not set as **Permanently detach**).
- Talkgroups in the user-activated scan list (if scanning is enabled and the SwMI-initiated detachment has not been performed on these groups).
- Talkgroups in the SwMI-controlled scan list (if scanning is enabled).
- Talkgroups with the class of usage set to **Always Scanned** (if supported).
- Supergroup of the selected talkgroup.
- Supergroups of the scanned talkgroup.

Priority Monitor

While the radio is active in a group call, it may receive a group call setup for a different group. The radio decides whether to ignore the new call or accept it basing on the call priority. If the new call has the higher priority than the current one, the new call may be joined and the current call is dropped.

The following priority types are applicable to calls:

- Call priority indicated in the call setup signaling.
- Priority of the group indicated by the Class of Usage (CoU) negotiated upon attachment.

If the old call and new call have different call priorities, the radio follows the call with the higher call priority. If the calls have the same call priority, the CoU priority of the group decides.

If a radio is in a group call, but is not currently the talking party, and detects a call setup for a different group with the same priority, it joins the call if a CoU priority is higher.

The radio can be set up not to immediately join the new higher priority call but to present the new call to the user before joining it. If so provisioned, you are given a choice of following the new higher priority call or staying with the present call.

The radio can be set up to treat a selected group call as a higher priority than a scan group call. This behavior occurs regardless of the priority of the calls or the groups.

Announcement Talkgroup

The radio supports the concept of a group hierarchy. A special group, an announcement talkgroup (ATG), in addition to being a group, logically contains up to 20 subgroups.

When you select an ATG as the selected group, the radio monitors traffic received for the announcement group as well as the traffic received for any of the associated subgroups. However, the radio does not monitor the active scan list groups when an announcement group is selected.

When you select one of the subgroups of the ATG, the traffic for the subgroup is monitored as well as the traffic for its announcement group, not other subgroups though.

Each normal talkgroup may be associated with only one ATG. An ATG cannot be associated with another ATG.

Depending on the codeplug settings, you may be prohibited from initiating ATG calls. In such case, you are still permitted to initiate an emergency call to an ATG group.

Broadcast Call Initiated by User

This feature allows you to make a Broadcast Call from the radio initiated on the predefined talkgroup. The alias (message) displayed during Broadcast Call, as well as the call priority and destination address (talkgroup), can be configured in codeplug. This feature can only be used in TMO mode.

During Broadcast Call, other features are impacted:

- No other services except emergency are allowed (same as in emergency mode)
- Hot Mic functionality cannot be used.
- When Broadcast Call begins, any other ongoing services are terminated.



Note: If the type of the encryption is defined by the BSI feature (radio with a SIM Card), the Broadcast Call is always clear. Otherwise if the radio uses other encryption service the type of the encryption used for that Call is up to the encryption settings of that service.



Note: Not all infrastructures support this feature. Consult with your service provider before enabling this feature.

Timed Talkgroup Change

This feature allows switching between the original and the predefined talkgroup (TMO or DMO) by using a One-Touch Button.

The radio attaches to the selected, predefined talkgroup only for a specified amount of time (**Functional Timer**). After the timer expires, the radio returns to the previously attached, original talkgroup. Returning to the original talkgroup can also be assigned to the second press action of the button.

A campus university combines four buildings: A, B, C, and D. A security procedure is to raise an internal alarm for the building and then notify the entire campus. The staff in each campus building configures radios with three types of talkgroups.

- 1 Internal Communication Talkgroups – regular talkgroups for the entire campus and individual buildings to communicate between staff members.
- 2 Internal Alarm Talkgroups – emergency talkgroups, individual for each building.
- 3 External Alarm Talkgroup – an emergency talkgroup to alert the entire campus.

The staff in individual buildings uses the dedicated Internal Communication Talkgroups for daily routines and the Internal Alarm Talkgroup for safety procedures. The campus staff in every building also scans the External Alarm Talkgroup.

The campus IT administrator assigned in CPS the **Timed TG Change** function to a One-Touch Button to switch between the original Internal Communication Talkgroup, and the Internal Alarm Talkgroup. This way the radio users can immediately switch to the emergency talkgroup and start an internal emergency call.

One of the staff members in building A is in an emergency situation. The person presses the One Touch Button to switch to the Internal Alarm Talkgroup and starts the emergency call. The other staff members in building A hear the voice communication on the Internal Alarm Talkgroup. It turns out that the emergency is serious and one of the building administrators starts the global alarm for all campus buildings.

Broadcast Call

This kind of call enables dispatcher to transmit to all radios in the specific area.

The radio joins calls received with a communication type broadcast and displays a notification that this call is a broadcast call.

Typically, this call type is addressed to the broadcast address (ISSI).

A broadcast call takes precedence over any other call that has the same or lower call priority.



Note: The radio cannot initiate a broadcast call, however, the radio is able to initiate the "broadcast-type" call restricted to the particular talkgroup using the Announcement Call feature.

Announcement Call

This feature allows you to make a Broadcast Call from the radio initiated on the predefined talkgroup. The alias (message) displayed during Broadcast Call, as well as the call priority and destination address (talkgroup), can be configured in codeplug. This feature can only be used in TMO mode.

During Announcement Call, other features are impacted:

- No other services except emergency are allowed (same as in emergency mode)
- Hot Mic functionality cannot be used.
- When Announcement Call begins, any other ongoing services are terminated.

If the type of the encryption is defined by the BSI feature (radio with a SIM Card), the Broadcast Call is always clear. Otherwise if the radio uses other encryption service the type of the encryption used for that call is up to the encryption settings of that service. Not all infrastructures support this feature. Consult your service provider before enabling it.

PTT Double Push

The PTT double push (D-PTT) feature enables to generate a specific tone sent to radios in the talkgroup. You can send the tone by pressing twice PTT, or pressing once a One-Touch Button (if configured by the service provider). After the D-PTT tone is played, you can press and hold the PTT once again to get the permission to talk. Otherwise if you press the PTT while the D-PTT tone is played, it is ignored. D-PTT tone is not audible on sending radio.

To send the tone (when the feature is enabled), you press the PTT twice in a period defined in CPS. The D-PTT is triggered only when the radio is in idle or group call mode. The D-PTT tone is not played on the sending radio.

If the PTT is kept pressed after second press and the radio finishes sending the D-PTT tone it allows starting group call. You are notified of the behavior by the permission to talk tone after D-PTT tone ends. If PTT is released after the second press, only the D-PTT tone is sent.



Note: The D-PTT tone is sent as voice, hence the receiving radio plays the sound no matter whether the feature is enabled on it.

You can adjust the D-PTT tone volume level in the speaker/earpiece of the sourcing radio. Disabling all the tones does not affect the sent tone volume. From the MMI you can change the D-PTT tone to be single, double, or triple. The tone type can also be changed in the codeplug.

PTT Queue

This feature allows you to configure the response to releasing PTT of the call originating radio. This determines how to cancel waiting for the call when the infrastructure is busy and your call is queued.

Talking Party Identification

The PDUs and facility elements for these TETRA Supplementary Services are not supported. However, identification presentation functionality is supported in most cases using the information found in the call setup messages.

Call Ownership

The radio can be given the call ownership of a talkgroup call. When the radio is the call owner, it sends an appropriate TETRA signaling to end the call.



Note: The SwMI decides about the ownership of a call.

Transmission During Group Call

While receiving a group call, and the **PTT during received Group Call** is enabled, you may request to transmit by pressing and holding the PTT. The system registers this action and informs you that the request has been queued.

If you release the PTT, the radio sends a message to the system withdrawing the request.

Call Restoration

If the radio roams to a new cell during a call, it attempts to continue the call on the new cell. Cell reselection and call restoration procedures are employed for this attempt.

If the radio roams while being the transmitting party in the call, an announced cell reselection, if possible, is carried out in the new cell.

If the radio is not the transmitting party, an unannounced cell reselection is employed, followed by call restoration procedures.

Temporary Group Address

The radio supports the temporary group address assigned by the SwMI. The address is valid only for the lifetime of the call.

The radio monitors signaling addressed to the temporary group, when the radio initiates a group call on the selected group, and the SwMI assigns the call to a temporary group.

The radio supports assignment of an incoming group call to a temporary group address.

Late Entry

The user can join the group call even if not participating in it from the beginning. This is possible for example, if a user turns on their TETRA terminal, in such a case the system diverts the user's terminal to a talkgroup call, if a call is already in progress. Similarly, if the user's terminal has been outside of the radio coverage, for example in a tunnel, the control channel will also divert the user's terminal to a talkgroup call assuming a call is already in progress.



Note: For TMO this feature must be configured on SwMI. Acknowledged late entry, and late entry paging are not supported.

User Initiated Group Attachment

To enable a radio to use a group, the radio should attach the group. The radio initiates a group attachment request to the SwMI after the RCU initialization. The attachment occurs whenever you initiate a group change and when the radio registers on a new site. When you change the selected talkgroup, the radio initiates an attachment to the SwMI, detaching the old group and attaching the new one.

All group attachments sent by the radio are sent with attachment mode of **Amendment** or **Detach all...** depending on which form causes sending less bits over the air interface.

When you turn on scanning and then select the scan list, the radio sends a group attachment request to attach the scan groups in addition to the selected group. Similarly, when you select an ATG, the radio sends an attachment of the ATG as the selected group along with the attachment of the associated groups as scan groups. If a group associated with an ATG is selected, the radio sends an attachment of the ATG as the selected group and as a scan group.

The TETRA TIP provides a facility by which the radio can send a status message to the SwMI to turn scanning off and on to save air interface signaling.

If the radio is provisioned with this option, when you turn scanning off, the radio sends an appropriate TETRA signaling. In this state, the radio does not monitor any groups other than the selected group. If you then turn scanning on, the radio sends an appropriate TETRA signaling and begins monitoring all scanned groups again.

If the radio is not provisioned with this option, you only have an option to deselect the active scan list. However, you cannot turn off the scanning. Deselection of the user scan list causes a group detachment of the scan list groups sent to the SwMI. However, the radio continues to scan all other groups (such as ATG associations).

SwMI Initiated Group Attach/Detach

The Switching and Management Infrastructure (SwMI) can send a talkgroup attachment to the radio. The radio will attach to it, even if this talkgroup had not been programmed in the codeplug.

If the radio receives a SwMI initiated attachment for the group already currently selected, the radio accepts the attachment, and keeps the group selected.

If the radio receives a SwMI initiated attachment for a group in the currently active scan list, the attachment is accepted. If it is for a group that is not in the current active scan list, the attachment is rejected.

If the detachment is for the selected group, the display indicates that no group is currently selected. If the detachment is for a group that is in the scan list, the group remains in the list. However, it is not monitored. If the detachment is for a group that is in the SwMI controlled list, it is removed from that list.

Private Call

The Private Call, also called point-to-point, or individual call, enables calling between two individuals. No other radio can hear the conversation. This call type can be carried out in two ways:

- Duplex call (if the system allows), in TMO Mode. Both parties can speak at the same time.
- Simplex call, in TMO or DMO Mode. Only one party can speak at a time.

From your radio, a Private Call can be started using one of the following methods:

- Dialing ISSI number on the idle screen
- By selecting contact from the address book
- By selecting ISSI number from the recent call list
- Using Remote Control feature
- By pressing predefined One Touch Button
- Other

When a DMO Private Call takes place, radios not involved in this call receive the channel busy indication. The radios are identified using their radio numbers.

Simplex Private Call

The radio is able to make and receive private calls to and from other TETRA radios with simplex speech capability. This call type uses TETRA individual call signaling.

All private calls are initiated using the on-off hook method. For incoming calls, the radio accepts both direct and on-off hook setup.

Duplex Private Call

The radio allows making and receiving private calls to and from other TETRA radios with duplex speech capability. Depending on the configuration, the radio may prohibit you from initiating duplex private calls.

The radio always initiates duplex private calls using on-off hook signaling with the traffic channel allocated by the SwMI only after the called party has answered the call. Therefore, the radio generates all progress tones during the call setup. In addition, the radio allows the SwMI to modify the call setup to direct. This modification enables the infrastructure to generate the progress tones.

Talk Time Limit

In a simplex call, the radio limits the time you can continuously talk in a group call without interruption, according to a provisioned value. You are warned a short time before the talk time expires. The timer is provisioned per talkgroup folder.

Call Restoration in Private Call

If the radio roams while you are the transmitting party in a private call, the announced cell reselection is employed (if possible). Call restoration procedures are performed in the new cell.

If you are not the transmitting party, the unannounced cell reselection is employed, followed by call restoration procedures.

Call Modification

Call Modification is a feature that allows your service provider to modify the call in order to optimize it and adjust to a current situation.

Modification can cover:

- Call priority — modified during call setup.
- Call type — modified during call setup.
- Call encryption — modified during an ongoing call (but not in the transmission phase).

When the call is modified, your radio displays **Call Modified** message.

When a recently modified call requires the PTT button to transmit, your radio displays **Call Modified Use PTT**.

All modifications are made by your service provider and the radio only follows them. You have no influence on ongoing call modifications.

When call priority is changed to emergency:

- The display indicates that an Emergency Group Call has been received.
- The radio plays a special audio alert.



Note: If a Group Call is modified into an Emergency Group Call, no emergency related features are triggered.

If call modification requested by your service provider cannot be followed by the radio (due to its settings), the radio rejects it and displays **Service Not Available** message.

Assistance Call

Assistance Call feature helps you to call for assistance during normal and non-critical situations. Starting an Assistance Call means starting a private call on a configured ISSI number. Assistance Call destination address and priority can be configured in the codeplug. This feature is only supported in TMO mode.

Assistance Call can be a simplex or duplex call depending upon your service provider settings. An Assistance Call is full-duplex when you start the call using radio menu. When you type the number and press PTT, then your radio starts a half-duplex call, but if you type the number and press SEND, then the call is duplex.

DMO Individual Call Presence Check

If the other party is listening, the Presence Check feature allows the user making a DMO private call to have a confirmation. This is important in situations where it is crucial that the message gets through. A radio with Presence Check enabled displays the “Party not available” message if the other party does not answer. To use this feature, both radios need to support it.

In addition, radios can be configured to Accept DMO Individual Calls with Presence Check. If enabled, the radio accepts incoming calls with or without the presence check. If disabled, the radio only accepts private calls without the presence check.

DMO Individual Only Talkgroups

It is possible to configure some or all DMO talkgroups to allow only individual calls. This helps optimize frequency allocation in Direct Mode Operation.

Phone Call

The phone call service enables a radio in TMO to communicate in a one-on-one simplex or duplex conversation with a phone (for example, a phone calls-enabled TETRA radio or landline number) using a telephone switch. The radio supports individual call service to an external identity.

Two phone call types are available:

- PSTN (a full phone number) is addressed to the defined PSTN gateway address.
- PABX phone number, for internal calls, numbers dialed are addressed to the defined PABX gateway address.



Note: The PSTN phone call is supported when PSTN/PABX feature is enabled in the codeplug and the SwMI supports this functionality. The PSTN/PABX gateway must be configured properly.

No more than one PSTN/PABX gateway ID and one PABX/PABX gateway ID are available in the radio.

Phone Call Initiation

The radio is able to initiate phone calls to a PSTN/PABX with duplex speech capability. This call type uses TETRA individual call signaling using single stage dialing and hook setup for outgoing calls.

Using the hook signaling for phone calls, implies that until a traffic channel is allocated, the radio generates all feedback tones internally. In addition, the radio accepts SwMI modification of the call setup to direct, enabling the infrastructure to generate the progress tones.

Phone calls can also be made between TETRA radios using the MS-ISDN number as the called party number. MS-ISDN calls share the same gateway as phone calls, that is, PSTN gateway configured in the codeplug. If an MS-ISDN call is placed, two radios can have a simplex or duplex call based on assigned ISDN number.



Note: The Dimetra Infrastructure does not support private calls and SDS through MS-ISDN.

Phone Call Reception

Incoming phone calls (land gateway to mobile) use on-off hook signaling. The radio extracts the gateway ID from the call setup signaling, to determine whether to start phone or PABX call. That means you need to answer the call e.g. by pressing the SEND button.

Call Restoration in Phone Call

If the radio roams while being in an active phone call, and the announced cell reselection is possible, then the announced cell reselection is employed. Also the call restoration procedures are performed.

Emergency Operations

Emergency Operations are used in critical situations.

Pressing the EMERGENCY button or entering Emergency number and pressing the SEND key, activates one or more services (depends on the service provider setting):

- Sending Emergency Alarm
- Sending SDS Status
- Starting Silent Emergency
- Starting Hot Microphone operation
- Starting Emergency Individual Call (Private or MS-ISDN)



Note: It is possible to power up the radio by pressing the Emergency Button. Depending on the service provider settings the radio can start Emergency Operations automatically. If the radio was PIN-protected (except SIM PIN), Emergency Operations will bypass the PIN lock for the duration of the Emergency Operations.

During Emergency Operations, the radio automatically rejects phone, PABX and private calls, and does not monitor the talkgroups in the selected scan list. However, if an ATG is the selected group, the radio monitors the sub-groups associated with the ATG.

When entering Emergency Operation, any ongoing voice call is aborted or cleared down. Any packet data transfer in progress is aborted. However, the session is kept open.

Emergency Group Call

The Emergency Group Call has the highest communication priority that means it is the pre-emptive call. Emergency Group Call is available in both TMO and DMO modes. During Emergency Operations, Emergency Group Call can be started by pressing PTT. The MS may also support Hot Microphone operation, which allows the Emergency Call to be conducted without pressing PTT.

If a radio receives an incoming group call with emergency priority, the display shows that an emergency call has been received, and a special audio alert is played.

An emergency group call can be configured as non-tactical or tactical:

- A non-tactical call is initiated on a talkgroup designated by the codeplug setting. When in non-tactical emergency mode, you cannot switch talkgroups.
- A tactical call is initiated on the currently selected talkgroup

In TMO, if the radio enters emergency operations while the emergency broadcast call is active the radio continues on the call without initiating any calls and sends an emergency alarm.

Non-Tactical Emergency

In Non-Tactical Emergency, the radio switches to a designated Emergency talkgroup when starting Emergency Operations. This talkgroup is used for the complete duration of the Emergency Operations (you cannot change the talkgroup).

In TMO, it is possible to configure the radio to make Emergency Non-Tactical Group Calls without sending attachment. If this is set, the radio assumes implicit attachment after receiving a temporary address.

In DMO, the Non-Tactical Emergency proceeds on the same frequency as the previously selected talkgroup. The service provider can designate any ITSI address to be used for Emergency Operations, (this can be an Open Group – broadcast address).

After exiting from Non-Tactical Emergency, the radio goes back to the previously selected talkgroup.

Emergency Individual Calls (Private or MS-ISDN)

The Emergency Individual Calls are Simplex or Duplex Calls with emergency priority. On pressing the EMERGENCY button, the radio initiates an Individual Call to the provisioned address (private or MS-ISDN). During this kind of call all user indications are unavailable and all other services are rejected. Emergency Operation ends as soon as the Emergency Individual Call is ended.

Emergency Alarm

The emergency alarm is a special status message sent to the infrastructure while starting the Emergency Operations. The radio may wait for infrastructure acknowledgment for this alarm and attempts retries.

Each time the radio enters the Emergency operation, it sends an emergency alarm. When an emergency alarm is sent successfully, the respective audible tone sounds.

In addition, once the radio is in the Emergency Operation on pressing the EMERGENCY button, an additional emergency alarm is sent. (Exception: during Hot Microphone transmission).

The message can be dispatched both in TMO and DMO.

Emergency SDS Status

Radio sends a status message with a preprogrammed value to the destination address set up in the codeplug. Emergency Short Data Service (SDS) Status is available in TMO only. If no status acknowledgment or negative acknowledgment is received, the radio retries sending the message. Status is not resend if Emergency Alarm or Hot Microphone is configured.

Emergency Hot Microphone

The Hot Microphone allows you to talk without pressing the PTT button during Emergency Operations. The transmission continues for a provisioned amount of time. Pressing the PTT button before the Hot Microphone time expires ends the Hot Microphone operation. Then normal PTT operation in Emergency group call takes over (that is, the transmission is ongoing for the time the PTT button is held).

Subsequent EMERGENCY button presses during the Emergency Operation restarts the Hot Microphone transmission.

If a talk permit is granted to another member of the group, the Emergency Call received tone is played. If configured, the radio automatically attempts to get talk permit again.

Pressing **EndSOFT** key or END key ends the Hot Microphone operation.

Alternating Hot Microphone

The Alternating Hot Microphone is an enhancement of the Hot Microphone feature. It allows you to have the Hot Microphone switched on and off alternately.

If this feature is enabled, you can initiate the Alternating Hot Microphone by pressing the EMERGENCY button.

The Alternating Hot Microphone terminates when one of the following conditions is met:

- The radio exits the Emergency Mode.
- The Alternating Hot Microphone timer expires.
- The PTT button is pressed.
- The right SOFT key is pressed (only during the transmission timeslot).

To skip your transmission timeslot and jump to a receiving timeslot, press END key.



Note: When the radio goes out of the service, it enters the receiving mode and the Alternating Hot Microphone is on hold. When the radio is back to the service, the Hot Microphone transmission and the Alternating Hot Microphone resume.



Note: When the user is in the Emergency Mode, pressing EMERGENCY button restarts the Alternating Hot Microphone.

Silent Emergency Mode

The Silent Emergency Mode is a type of emergency services that provides no audible indications and no keypad tones at the entrance. All the display indications are as in the home mode. However, the radio cannot use any services except for:

- Receiving Ambience Listening
- Sending Silent Emergency Alarms
- Sending GPS location reports



Note: If you try to activate any other feature, it is blocked.

If the Silent Emergency feature is enabled, the radio enters Silent Emergency Mode on pressing the EMERGENCY button. After entering this Mode the radio stays in TMO or switches to it, depending on the actual state. Once in TMO, the radio sends Silent Emergency Alarm.



Note: If the radio is in a private or group call, the radio waits until the call ends and then enters the Silent Emergency Mode.

The radio keeps re-sending the alarm until successful sending is confirmed. After the alarm is successfully delivered, the radio stays in Silent Emergency Mode and waits for the Ambience Listening.

Your radio exits the Silent Emergency Mode, under the following conditions:

- Press MENU and then # key within 3 seconds.
- Press MENU simultaneously with right NAVIGATION key.
- Press both SOFT keys simultaneously.
- No success in sending the Silent Emergency Alarm and the maximum number of retries has been reached.
- The control room terminates the Silent Ambience Listening.
- The Ambience Listening is disconnected due to another reason.

If you turn off the radio in the Silent Emergency Mode, the radio switches to pseudo power off state. In this state, the radio appears to be turned off. However, the radio is still on and in the Silent Emergency Mode. On turning the radio on during the pseudo power off state, the radio acts as during turning on and still is in the Silent Emergency Mode.

Invisible Emergency

It is possible for the service provider to disable visual and audible indications of performing Emergency Operations on the radio. The purpose of this feature is to hide the fact of using Emergency Operations in a critical situation (e.g. direct attack on the user) and thus to provide additional layer of safety.

Disaster Alert

Disaster Alert call is a broadcast emergency call initiated by the radio, with emergency pre-emptive priority that everyone in a broadcast area can hear. This feature is specifically designed for catastrophic situations, such as earthquakes, and has the highest priority over other calls. All radios under Disaster Alert display emergency notification on their screens. The alert message, its duration and destination talkgroup can be configured in the codeplug.

In order to initiate Disaster Alert, switch the radio to Disaster Alert mode and press PTT button. When the call ends, the radio will exit the Disaster Alert state.

During Disaster Alert, other functionality is impacted:

- When Disaster Alert begins, any other ongoing services are terminated.
- No other services can interrupt this type of call.
- Hot Mic functionality cannot be used.

- Speech can only be in Clear mode, even if any of the encryption services are enabled. The only exception is E2E Encryption.



Note: Not all infrastructures support this feature. Please consult with your service provider before enabling this feature.

Short Data Services

The radio supports the following Short Data Service (SDS) message types:

- SDS Status.
- SDS User Defined Data Types 1, 2, 3.
- SDS User Defined Data Type 4 with or without SDS Transport Layer (SDS-TL).

The feature supports the following addressing modes:

- Radio to radio.
- Radio to talkgroup.
- Radio to external subscriber number (gateway address).



Note: For SDS-TL, the message can be sent through the service center.

The radio provides a short data bearer service for both internal and external applications.

The radio supports SDS-TL services which provide end-to-end acknowledgments, delivery report requests, and message numbering for SDS user-defined data type 4 messages. The TL also provides SDS access for applications that do not request these transport layer services, however, use a Protocol Identifier (PI). The radio can send the delivery report by using an appropriate TETRA signaling, even if the originator requested a short report. The radio can support the old SDS-TL standard for operation on legacy systems, or for operation on other SwMIs.

An externally connected device may access the SDS services in the radio using AT commands and TNPI protocol. An external application may use this service to send and receive SDS statuses, SDS user-defined data types 1, 2, 3, and 4.

Downlink SDS messages type 4 are presumed to contain a PI for identifying the target application. If an external application has registered with the radio for that PI, the radio delivers the message to the target application. The radio may receive downlink SDS messages that are successive retransmissions of a message already received and acknowledged by the radio. The radio does not display these messages, nor store in them in the inbox, nor send them to an external application.

Status Messages

You can select from a list of up to 400 pre-programmed alphanumeric aliases each of which corresponds to a status value. The valid range of uplink status values is a set of provisioned parameters. If the radio is not enabled with targeted status, the status value is sent over the air interface to the address of the selected group. The radio recognizes the general status acknowledgment sent from the SwMI, as well as the negative acknowledgment. In TMO, if no status acknowledgment or negative acknowledgment is received, the radio retries sending the message. The number of retries and time to wait before retrying are provisioned parameters. You are notified of the delivery status. As there is no acknowledgment for DMO status messages, you are notified only of sending the status message. The radio does not initiate sending of status messages on a traffic channel.

If the radio is provisioned with the targeted status, the status value is sent over the air interface by default to the last sent target. You have also an option to specify a different individual or group to send the message to. In other words, you can send an SDS status message to a directly entered ID (for example, ISSI, GSSI, MS-ISDN). If the radio is not provisioned with the targeted status and you want to send an SDS status message, the following possible actions apply:

- When the default address type of targeted SDS status is set to **Private** or **Phone**, the default address is used as ISSI, GSSI or ISDN, depending on configuration.
- When the default address type of targeted SDS status is set to group, the selected talkgroup address is used.
- When the targeted SDS status is set to 'Dynamic', the status message is sent to the address configured for the Dynamic statuses, or defined by a dispatcher (by means of SDS Remote Control).

The radio accepts status messages from addresses it is monitoring. The radio can be preprogrammed with an appropriate text associated with each status value. The radio notifies when a new status message has been received. Upon receiving an incoming status message, the stored text corresponding to the status value is extracted and placed in the text message buffer as a text message. Receiving a status causes the radio to display the message mail screen, allowing the user quick access to read the message. A received status can be stored in the radio text message buffer.

The PEI provides access for external applications to send and receive status messages.

Shadow Groups (Address Bundle)

The Shadow Groups feature offers a way of sending statuses to multiple destinations or recipients simultaneously. Each radio can store up to 255 Address Bundles.

Three types of Address Bundles are supported:

- Status Addressing (including emergency alarm)
- GPS LIP Addressing
- RMS/FMS Addressing

Shadow Groups in TMO

Each Address Bundle may contain up to four target addresses (ISSI or GSSI). Each talkgroup may be configured to send statuses, GPS LIP reports or RMS/FMS messages to a specific Address Bundle.

Shadow Groups in DMO

In DMO the Address Bundle contains one target address (ISSI or GSSI). Each talk group may be configured to send statuses or GPS LIP reports to a specific Address Bundle.

The Shadow Groups feature may affect Emergency Calls setup time to be slightly elongated.

This is a selling feature.

Text Messages

The radio supports an internal text messaging application using the TETRA SDS Transport Layer. The radio can send and receive up to 140 bytes of payload data (which can be up to 160 characters, if a 7-bit encoding is used).

Depending on radio settings, for each message in the **Inbox**, the following options are available:

- **Store** — used to save the message as a template.
- **Delete** — used to remove the message from the list.
- **Delete All** — used to remove all the messages from the list.
- **Reply** — used to send a reply to the message originator with the option to edit the text (where available).
- **Forward** — used to send the current message to another recipient with the option to edit the text.
- **Refresh** — used to reorder the messages list and see the newest at the top. When you are in the **Inbox** and the new message comes, refresh the list to see the new message.

The radio provides an edit facility for composing and editing a text message. The message can be sent to a target TETRA radio using SSI addressing, and is sent with a request for a received delivery report.

All the outgoing text messages (short or long) are stored in **Outbox**, when the store and forward mechanism is not in place. When the store and forward feature is enabled and the messages go through the store and forward server, the short messages are stored regardless the delivery status. Whereas, long messages are stored only if delivered (even if only to the store and forward server). Depending on radio settings, for each **Outbox** message the following options are available.

- **Store** — used to save the message as a template.
- **Delete** — used to remove the message from the list.
- **Delete All** — used to remove all the messages from the list.
- **Resend** — used to send the message again to the same recipients with the option to edit the text.
- **Forward** — used to send the message to the other recipient with the option to edit the text.
- **Refresh** — used to reorder the messages list and see the newest at the top.
- **Delivery Status** — used to check the time and the date when a message was sent, delivered, read, expired, or not delivered. Every status change is communicated.

Delivery report is saved in the **Inbox** and in the associated message in **Outbox**. However, the report is deleted from the Inbox after viewing it.

Outbox and **Inbox** share memory area, hence their capacity depends on the combination of stored short and long messages in each of these folders. If **Inbox** is empty, **Outbox** may store up to 100 short messages or at least 20 full size long messages. If **Outbox** is empty, **Inbox** may store up to 100 short messages or at least 10 full size long messages. When you enter **Messages** submenu, the number on the right side of **Inbox** and **Outbox** is indicating the number of the messages stored. If the **Outbox** is empty, then the radio displays **No Messages** notification.

Upon receiving a text message, the radio places the text into a circular buffer. You are notified when a new text message is received and a quick access to read the message is provided. If a delivery report is requested, the radio sends it upon receipt of the message by SDSTL. If a consumed report is requested, the radio sends it when you read the message.



Note: If you read the message when the radio is out of service, the report may not be sent.

You can save incoming or edited (outgoing) text messages. These messages can be edited and sent.

For each message, you can verify its timestamp. The timestamp displayed is extracted from the SDS TL PDU. The timestamp is generated and inserted to the message by the SwMI.

SDS Messages Concatenation

This feature allows sending long text messages up to 1000 characters. All the messages that are longer than 140 characters are divided and sent separately one after another. When a recipient receives all the parts of the message, it displays as one on the screen.

When the radio receives an SDS message and the **Inbox/Outbox** is full, the radio acts according to the **Buffer Full, Overwrite Policy** codeplug field settings.

When the text or status message is received and accepted, the radio retrieves actual time information from its internal clock.

The radio can reconstruct a long text message consisting of up to ten short messages. The maximum length of the message is 141-1000, what can be defined in the codeplug. The radio recombines the text segments independently of the order they have been received to the correct order of the original message. The message can be combined only if all their message reference number are correct and the segmented receiver timer is still valid.

You can send long text messages to an individual destination. However, sending long text messages to groups is not possible:

- Receiving the message during group/broadcast call — radio allows receipt of the text message during ongoing group call and broadcast call. The group/broadcast call is displayed with the **New mail arrived** icon and tone for mail reis played.
- Emergency Mode — you can receive SDS messages. To read the SDS messages the radio have to leave the emergency mode. Sending the SDS messages in the emergency mode is prohibited.

Immediate Text Messages

Immediate Text Messaging is a selling feature which enables displaying the text message immediately on the radio display. This feature is used for sending high important information from the console to radios.

When the radio has the feature enabled and receives an immediate text message, then:

- the immediate text message is stored in the **Inbox**.
- the content of the immediate text message is displayed.
- the relevant audio tone is played.
- additionally if the periodic alert feature is enabled, the periodic alerting is active until the immediate text message is skipped or closed.



Note: When the feature is disabled in the radio, then immediate text messages are processed as normal text messages.

When you reply or forwards an immediate text message, the message is sent as a normal text message.

When the radio receives more than one immediate text message, then just the latest received immediate message is displayed. All the previous immediate messages in the **Inbox** are not prompted.

Home Display Text Message

Your radio is provided with a feature that allows your service provider to send special text messages to the display. The message stays on the home screen until a new message is received. Power cycle your radio to replace the Home Display message to the predefined one.

Predefined Templates (ATS Entry Prompt)

This feature assists the radio in sending formatted messages with a predefined destination address (MS-ISDN, SSI or TSI) for computer applications.

You can select a predefined entry prompt which defines a message format to assist in the construction of an SDS message. The prompt definition is set in the codeplug. The definition sets areas that are read-only, areas that can be edited, and the type of characters that can be entered (numeric, alpha-numeric or phone digits). Along with the message definition, the address to send the message is provided.

When you send the message, it is sent using SDS-TL with the PI that is provisioned in the codeplug. A receipt report is requested.

SDS Air Interface Aspects

The radio can be provisioned to send a short-form SDS-TL receive report when the originator of the message allows short-form report. The short form report uses specially designated SDS status values instead of SDS-REPORT.

The radio supports SwMIs that employ store and forward service as indicated in the cell broadcast information. The radio supports use of a service center, which address is set in the radio. The store and forward operation is supported. However, the radio notifies you only on successful sending of the message. The radio does not wait for the report from the service center.

Downlink SDS messages types 1, 2, and 3 are always routed to the PEI when an AT application is registered. If no external application is registered, the message is discarded.



Note: The DMO SDS do not support type 1,2, and 3 user-defined short messages.

SDS Encryption

Short data messages stored in a radio are protected against any unauthorized access. The stored data includes messages in the **Inbox**, **Outbox**, and stored call out messages.

The required protection against any unauthorized access through the MMI, PEI, or unintentional access by other means is carried out through the special mechanisms. The encryption of stored messages preventing from accessing the memory directly and the user authentication protect SDS messages. Protected messages cannot be read on the radio MMI unless valid authentication occurs. For the user authentication, the existing radio PIN is used.

SDS messages received by the radio are encrypted before being stored in the Inbox. Store and Forward messages are encrypted before being saved in the **Outbox**.

Received call out messages are encrypted before being stored in the **CO Box**.

If the feature is enabled, then the radio prompts you to enter the PIN if any of the following menu items are selected from the MMI.

- **Messages** → **Inbox**.
- **Messages** → **Outbox**.
- **Messages** → **CO Box**.

Following successful PIN entry and access to the required messages, the radio does not require further PIN entries to access messages unless one of the following conditions has been met.

- Exiting from the radio menu.
- Turning off the radio.
- Changing the PIN from the MMI.

If you disable the PIN lock through the MMI or change the PIN, the protected messages are deleted. Before deleting the messages, you are prompted to ensure that the operation should proceed. If the PIN lock is changed through the PEI, all the protected messages stored in the **Inbox**, **Outbox**, and **CO Box** are deleted. On enabling the radio permanent disable, the access to the protected messages is lost.

SDS End-to-End Encryption

The TETRA standard supports the air interface security that provides protection of the air interface. The information flow inside the infrastructure is not secured. When you require data protection for your data going through the infrastructure, you need your entire transport path to be encrypted.

This entire path encryption is called end-to-end encryption (E2EE). The source and the destinations are supplied with the mechanism for encrypting and decrypting.

E2EE is a selling feature which provides customers with a higher degree of confidentiality than existing TETRA air interface data encryption.



Note: The 260–275 MHz radios do not support the SDS end-to-end encryption.

In air interface encryption, the receiving base station decrypts data which travels clear within the system domain. For E2EE, the transmitting radio encrypts the data and the receiving radio or an E2E terminator located in the infrastructure decrypts the data.

E2EE protects the SDS/SDS-TL data services both in TMO and DMO. The following TETRA data types are protected.

- SDS type 4 with SDS-TL.
- SDS type 4 without TL.

For short data applications, the source data may come from an external application or from a task internal to the radio, such as text messages or GPS. The radio passes only the internal text messages and GPS data for encryption by its crypto engine.

The encrypted short data service is established between two end points. One end point is terminated in the radio, and the other end point is terminated in a Short Data Encryption Gateway (SDEG) or another radio. The destination address specifies the encryption type, that is, whether the packets are transmitted as encrypted, clear or dropped.

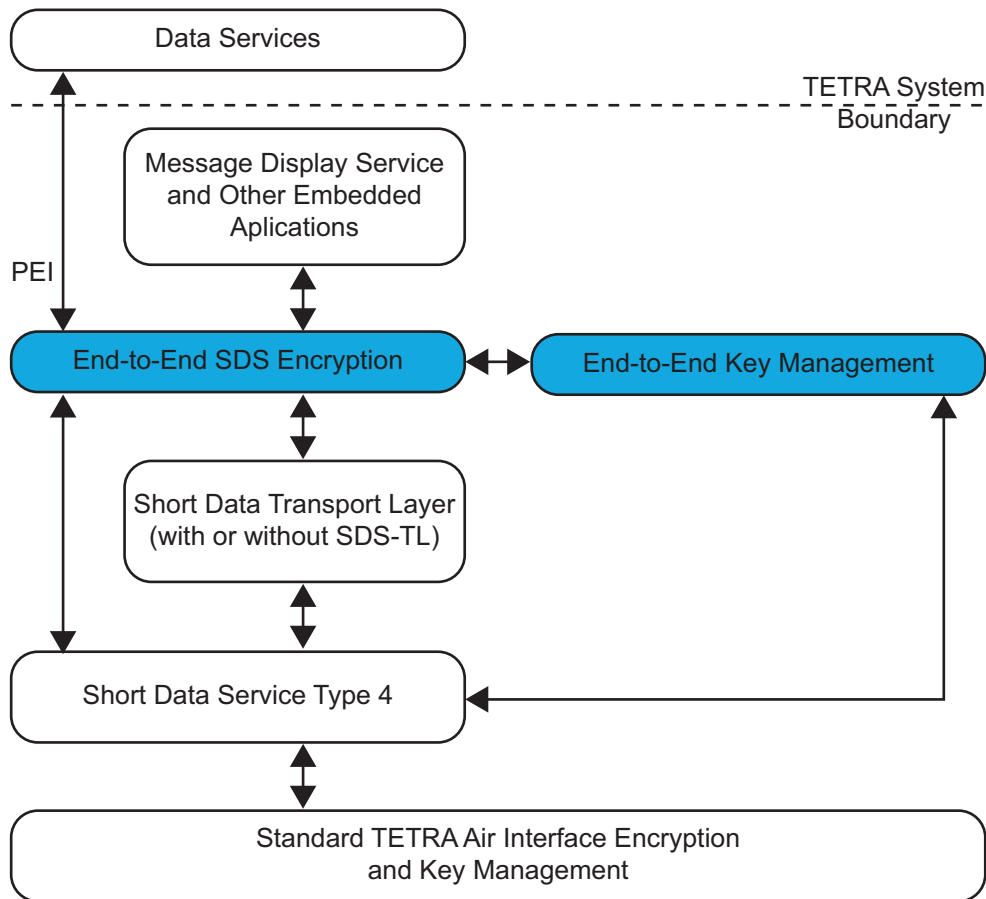
Figure 5: SDS End-to-End Encryption

Note: Key Management Facility (KMF) can manage and support only one short data association and a key at the same time.

The radio selects the E2EE mode for the outgoing text message in accordance to the address association and requirements for the E2EE High Security Mode. Depending on codeplug settings you can override the address association and select using the MMI menu whether an SDS is sent to clear or encrypted contact (Group or Private Number).

The radios support the high security mode configurable using the CPS. In this mode the association that binds the address to a given cryptogroup is always mandatory.

If no cryptogroup associations exist, this means that the keys are not loaded. In such situation, the radio discards any outgoing or incoming message that is encrypted. You are alerted when this situation occurs.

This feature can only be disabled using the KVL.

Store and Forward

This feature allows communicating with each other without being available at the same time. If the destination is not reachable, the message is stored in the system (if supported) until it is available or the expiration time is exceeded. The system is configured to delete the message after a preconfigured time and this time cannot be configured using the radio.

You can send the store and forward messages to an individual address or a group. Depending on the codeplug settings, if you choose to send it to the group, the message status is switched from **Store and Forward** to **Immediate**.

When the **Sending group message to Store and Forward Server** is enabled, an SDS message sent to a group is conveyed with assistance of the store and forward service. The radio sends Store and Forward SDS to group only with

Delivery Report Request set to **None** by the service provider. For Store and Forward SDS to an individual address, the radio can send SDS with any Delivery Report Request (None, Received, Consumed, Received and Consumed) the user set (via MMI or via codeplug settings). The radio does not request a delivery report, thus you are not notified of the delivery status.



Note: Verify whether the infrastructure system supports this functionality.

Security Services

The radio provides TETRA security features as described in the TETRA Security ETS 300 392-7 standard, TTR 001-11 TIP, and TTR 001-13 TIP.

Terminal Equipment Identity

The Terminal Equipment Identity (TEI) is unique identification number programmed in the radio at the factory and cannot be later modified.

PIN/PUK User Authentication

In order to authenticate yourself, the radio supports a Personal Identification Number (PIN) and PIN Unlocking Key (PUK) mechanisms. These mechanisms prevent from an unauthorized access to the radio. The PIN/PUK operations are available from both MMI and PEI (using AT commands).

For the authentication purpose the radio prompts you to enter a valid 4-digit PIN, before the radio allows to access all the available services. The PIN is defined in the codeplug.

If the maximum number of consecutive failed attempts is reached, the radio is blocked and remains in this state until unblocking. The permissible number of consecutive failed attempts is defined in the codeplug. The blocked status is sustained regardless of turning off or battery removal.

When the radio is PIN locked, you have no or limited access to the radio services. The PIN is defined in the codeplug. The radio is unblocked either by entering the PUK or by using the CPS. The PUK can be entered through the MMI or through the PEI. The PUK is defined in the codeplug.

Authentication

Authentication establishes a level of a trust between a radio and SwMI. It is a challenge-response result protocol between two parties based on their common knowledge of a secret key (K) to verify each others identity.

The SwMI authentication centre (AuC) provides a single K for authentication, which is shared only with the radio. Authentication is always initiated by the SwMI, the radio can also authenticate the SwMI (if set by the service provider).

Air Interface Encryption

The radio supports TETRA Air Interface Encryption (AIE) using the standard TETRA public encryption algorithms, as defined in TETRA Security ETS 300 392-7, TEA1, TEA2 and TEA3. The focus of cryptography in TETRA is the encryption key. TETRA AIE provides 12 000 000 000 000 000 000 000 000 key combinations.

TETRA TMO has three classes of encryption:

- Class 1 — clear (none).
- Class 2 — static key encryption (SCK).
- Class 3 — derived key encryption (DCK, sometimes called the dynamic key), the Common Cipher Key (CCK), and the Group Cipher Key (GCK).

TETRA DMO has two classes of encryption: Class 1 and Class 2.

The security features supported in the radio depend on the security mode.

Table 9: Security Features Required Per Security Class

Security Feature	Mode			
	Security Class 1	Security Class 2	Security Class 3	Security Class 3G
Radio Initiated Authentication	Not Allowed	Not Allowed	Not Allowed	Not Allowed
SwMI Initiated Authentication	Optional	Optional	Mandatory	Mandatory
Mutual Authentication	Optional	Optional	Optional	Optional
OTAR	N/A	Optional	Mandatory	Mandatory
SCK AIE	N/A	Mandatory	N/A	N/A
DCK AIE	N/A	N/A	Mandatory	Mandatory
GCK AIE	N/A	N/A	N/A	Mandatory



Note: In the current release the radio does not support the following security features:

- Radio initiated authentication
- Support for TEA4
- Explicit authentication during DGNA

Enhanced Security, which consists of TMO Air Interface Encryption class 3G and DMO class 2, is a selling feature.

Clear Radios (Class 1)

A radio can be configured as a clear radio. In such case the radio identifies itself in registration as a Security Class 1 radio and does not support encryption. A Security Class 1 radio does not contain any encryption algorithms in its software.

Static Cipher Key Encryption (Class 2)

The radio supports static AIE using a set of up to 32 static cipher keys (SCK) shared by the SwMI and all authorized radios. The radio then determines which static keys to use based on the SCK Number (SCKN) and SCK version number (SCK-VN) broadcast by the SwMI.

A radio can be configured to support static key encryption. In such case it identifies itself in registration as a Security Class 2 radio, and attempts to negotiate Security Class 2 encryption. Each radio then uses either the TEA1 or the TEA2 (TEA 3 — for Asia and Pacific) Key Stream Generator (KSG) algorithm. Each radio contains only one of those algorithms in its software.

When Security Class 2 Encryption has been negotiated, encrypted PDUs are encrypted using SCK.

In DMO, the system manager may choose the SCK and the key may be distributed from the TMO SwMI using the OTAR mechanism or provided manually using KVL.

Derived Cipher Key and Common Cipher Keys Encryption (Class 3)

DCK/CCK are required to prevent over-exposure of key material. Existing encryption systems use Static Cipher Keys (SCK), where one key is used for all radios and all calls. Key material is often exposed and SCK logistics of changing keys consist in programming all radios and base stations.

DCK is used for individually addressed TM-SDU (Service Data Unit). DCK/CCK encryption provides Derived Cipher Key (DCK) for uplink (from the radio to the BTS) communication and Common Cipher Key (CCK) for downlink (from the BTS to the radios) group communication. The DCK is derived from either the one way or mutual authentication process and the CCK is received during registry.

The radios supporting the dynamic key encryption identify themselves to the system as Class 3 radios during registry and attempt to negotiate Class 3 encryption. A Class 3 radio supports group addressed signaling and group call traffic encryption using CCKs as well as encryption of uplink and down link individually addressed signaling messages and individual call traffic (private or phone) using its DCKs. The radios support Over-the-Air-Rekeying (OTAR) of the CCK by the system.

A clear radio can set up calls to and receive calls from encrypted radios. The system informs the encrypted radios that the call is with a clear radio and they switch to clear operation. Class 2 and 3 radios can only act as described if they are allowed to operate in a lower class.

Group Cipher Keys Encryption (Class 3G)

For the Security Class 3G the system allows grouping addressed signaling and dedicated group call traffic encryption using GCKs to cryptographically isolate talkgroups. The downlink signaling is encrypted using MGCK that is cryptographically derived from the CCK associated with the serving cell and the GCK associated with a given talkgroup. The SwMI does not change GCK and CCK simultaneously. Whenever a GCK change occurs, CCK changes are frozen for this time period.

The DCK is derived from either the one way or mutual authentication process and the CCK is received during registry, whereas the GCK is received through OTAR mechanism only.

The radio supports over-the-air and manual provisioning of key associations that link a GCK to one or more TMO talkgroups, and manual provisioning of KAG to one or more DMO talkgroups.

The system can provide the ability for the operator to group contiguous ranges of TMO SSI. This case occurs where any talkgroup residing within the address range is assigned using the same GCK association. These ranges, referred to as Key Association Ranges (KAR), are used to convey the TMO talkgroup and GCK relationships to the relevant SwMI and radios responsible for GCK functions.

Secure DMO

The Secure Direct Mode Operation (DMO) feature guarantees key ciphered transmission in the DMO.

When DM-SCKs are provided by OTAR, you are informed in case the radio does not contain the complete set of SDMO keys. Whenever the radio enters DMO and the radio does not possess past and present DM-SCKs for all provisioned KAG and/or it has not yet successfully received SCK Subset Grouping Type, SCK Subset Number and SCK-VN information from the SwMI, then the radio:

- plays a special reject tone.
- prompts a message indicating **OTAR incomplete**.

The radio provides SDMO status information to the user via the MMI **DMOSCK Validity** submenu inside the **Security** menu (present only when configured in the codeplug):

- **DMO SCK is Valid** — DMO SCK OTAR is disabled and all DM-SCKs are provided using the KVL.
- **DMO SCK is Valid** — DMO SCK OTAR is enabled and the radio knows the current SCK information and has all the corresponding past and present DM-SCKs.
- **DMO SCK is Invalid** in all other cases.

The radio supports system management of SDMO keys. The radio using system managed SDMO requires the structure of DM-SCKs used for SDMO, the current active SCK Subset Number, and Version Number information to coordinate key schedules. The radio considers the last received variant of this information PDU as the most accurate indication of SDMO key configuration.

DMO SCK can only be used if Enhanced Security feature is purchased.

End-to-End Encryption

The TETRA standard supports air encryption. The radio creates the PDU (Protocol Data Unit) and the PDU is encrypted before transmission. The base station receives this PDU and must decrypt it, to know what to do with it and where to send it. Thus, if a PDU contains voice information, the voice part of the message has been decrypted and is now unprotected, until it is transmitted out to the caller.

Figure 6: Voice and Data End to End Encryption

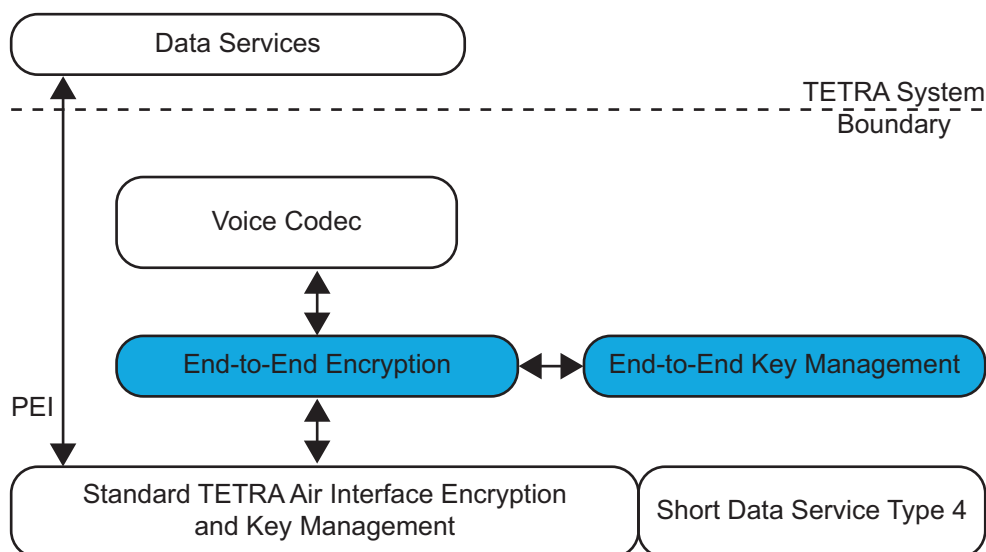

The End-to-End Encryption (E2EE) feature resolves this issue by encrypting the voice information before it is packed into the PDU. This message is also encrypted according to the over-the-air encryption of the TETRA standard. Thus, when the base station decrypts the PDU containing voice information, the voice part remains protected by encryption until the called radio receives the voice and decrypts it.

The Universal Crypto Module (UCM), located in the radio, carries out voice encryption. The UCM takes the voice stream and encrypts this stream using a set of keys. Likewise, the UCM takes encrypted voice stream and using the same keys decrypts back into clear voice.

In the end-to-end encryption feature, the radio notifies and informs whether the call, being made or received, is voice-encrypted. The radio also provides with means to select a different key, delete keys, request new keys and change the encryption mode of nondefined private calls.

This feature is relevant for group calls and private calls in TMO and DMO.

SIM Security

The SIM security consists of the following security functionality groups:

- Voice E2EE and related key management.
- Network access parameters and authentication.
- Key management for AIE.
- OPTA, modification, encryption, and transfer.
- AES for E2EE of SIM Interface and SIM-Terminal Authentication.

The SIM is an integrated circuit card, which holds a file system and an application. The application performs the following actions:

- Generation of key stream segments (KSS).
- Synchronization for E2EE.
- TETRA authentication algorithm based on K key on the SIM.
- Key management for E2EE keys.

- SIM interface encryption and authentication using the AES.

The file system holds the following.

- Network access parameters as ITSI.
- Security class definition and authentication definition.
- Integrated circuit card identifier.
- SIM version number.
- Operative Tactical Address (OPTA).

The E2EE keys are also kept on the SIM. However, they are accessible for the SIM application only, thus E2EE key management is transparent to the radio.

The keys for AIE remain on the radio. The SIM application handles AIE key management.

Radio Disable/Enable

On reception of an appropriate TETRA signaling for subscription disable with the correct SSI and MNI of the radio, the radio becomes disabled.

When disabled, the radio does not participate in any voice call, SDS, or packet data activity and ignores all supplementary services sent on the downlink. All visible and audible indications are disabled, and the radio appears to be turned off. All user inputs (key presses, knob operation) are ignored, and the PEI interface is closed.

The radio continues to perform mobility management functions, such as roaming, to facilitate subsequent enabling (or further disabling).

The radio stores the disabled/enabled state in the codeplug, so the unit remains in that state after turning on.

If the radio is in the disabled state, and receives an appropriate TETRA signaling for subscription enablement with the correct SSI and MNI, it restores to its normal operative state.

The TEI Query feature provides TEI information to the infrastructure during registration. This allows to disable the radio by sending an appropriate TETRA signaling for equipment disable with the correct TEI for this radio. Replacing the SIM card does not activate the radio.

If the radio is in the equipment disabled state, and receives an appropriate TETRA signaling with the correct TEI, the radio restores to its normal operative state (if the subscription is also in the enabled state).

Radio Permanent Disable

Permanent disabling is intended to protect a network from attack from a compromised or faulty radio. It can be used when the radio has been compromised, or has been suspected of compromise for a long time. It is a one-way function and no equivalent enable is available. Then the radio should be recovered and reprogrammed before being used again by the service provider.

When the radio is permanently disabled, it becomes inoperable.

- All its MMI interfaces on the radio are disabled.
- All its security key material, that is GCK, GSKO, DMO SCKs, Ks, DCK, CCK, TMO SCKs are deleted.
- All its codeplug is deleted.
- All its software is deleted.

The permanent disable should be invoked when it has been determined that a radio is unrecoverable. When a radio has been lost or stolen, the first step always is to stun the radio (using the temporary disable).

The permanent disable should be used with the deletion of the user radio record in the User Configuration Server and the deletion of the K-REF association of the disabled radio in the Provisioning Centre and the Authentication Centre. This deletion ensures that subscriber information is not downloaded into the Home Location Register if a restore of the UCS is performed.

The system operator has to also ensure that the radio K-REF association is also removed from the other Authentication Centres in the network, in cases where the K-REF pairs are duplicated across the network.

If this association is not removed, the radio could be assigned a new home zone that lies in a cluster where the K-REF association has not been deleted.

Radio Permanent Disable and Radio Permanent Disable v2 are mutually exclusive selling features.

Radio Permanent Disable v2

Similarly to the permanent disable, once the radio is disabled using the permanent disable v2, it cannot be recovered over the air. When the radio accepts the permanent disable command, and if the permanent disable v2 flag is enabled in the codeplug, the radio appears to be inoperable.

- All its MMI interfaces on the radio appear to be disabled.
- All its security key material; GCK, GSKO, DMO SCKs, Ks, DCK, CCK, TMO SCKs, and End-to-End key material are deleted.
- The radio automatically turns off on powering attempts without any audible/visible indications to the end users.
- The permanent disable flag is set in the codeplug.

Unlike in the permanent disable, a permanent disabled v2 radio can be re-enabled using the software selling dongle. If you have the software selling dongle, you can read the codeplug and clear the permanent disable flag.



Note: When a radio has been disabled using the permanent disable v2, entering programming mode procedure is different. For the details, see *TETRA Terminals CPS Start-up User Guide* (Motorola Part Number: 6802974C10).

Radio Permanent Disable and Radio Permanent Disable v2 are mutually exclusive selling features.

High Assurance Boot

The radio has a facility that ensures that the code and data flashed in the radio is authentic and has not been altered. The hardware forces the HAB module to run at boot time. The module checks if all software comes from a trusted source. The radio is checking the signature of the code and data segments present in the radio using a public/private key mechanism.

If the HAB authentication of the flashed software fails, it does not allow the radio software to run.

Packet Data

The radio provides, in the TMO, a TETRA bearer service for applications that use the IP protocol. This service is available to external applications by connecting using the PEI.

The radio supports TETRA standard multi-slot packet data using the IP network layer protocol through Point-to-Point Protocol (PPP), and TETRA SNDCP protocol. The IP connection is established between Terminal Equipment and Mobile Terminal, allowing external applications to communicate with Terminal Equipment using predefined IP addresses.



Note: This IP connection is referred to as the local link. The link established between the radio and the SwMI is referred to as the wide link. When a wide link has been established, the radio is considered to be in the wide mode.

Packet data applications reside internally, over UDP, or in an externally connected device connected via an 8-wire RS232 data port in the radio. Communication to the external radio is initialized using AT commands. Once the connection is established, the external application may request Point-to-Point Protocol (PPP) mode, and then operates in PPP mode until the data connection is terminated. The radios can operate both on the single-slot packet data channel and the multi-slot packet data channel.

The system provides point to point IP connectivity allowing the following datagram exchanges.

- Radio \longleftrightarrow External Equipment (Terminal Equipment) (for example PC).
- External Equipment (Terminal Equipment) \longleftrightarrow Network (through radio).

The radio supports only IP version 4 packets. The radio routes datagrams independently of the protocol sitting on top of IP.

The radio supports an MTU of 1500 bytes.

The radio provides the best effort delivery service. However, if the delivery fails, the originating user application is informed by sending back to Terminal Equipment an ICMP message, if possible.

The radio generates ICMP messages addressed to the Terminal Equipment in case of failed delivery due to the radio environment. The delivery may fail due to, for example:

- no radio coverage.
- failed transmission.
- service interaction.

The packet data service PDCH access signaling has the same priority as circuit mode setup-related signaling. The radio uses advanced link for PD transmission and supports advanced link flow control. The advanced link roaming, if the advanced link is not disconnected between cells, is supported, where the SwMI supports it.

The radio does not support data compression. If an application attempts to negotiate data compression during context activation, it is rejected. If a data compressed IP packet is received from the SwMI, it is silently discarded. The radio supports IP header compression negotiation received from Terminal Equipment during PDP context activation, and transparently transfers IP packets with the header compression between Terminal Equipment and the SwMI.

The packet data service employs the TETRA standard cell selection and re-selection. The packet data service is suspended while the reselection is occurring, and resumes when the cell reselection procedure is complete.



Note: The cell reselection is undeclared in a strict TETRA sense. However, the SNDCP protocol defines a procedure for reconnecting the packet data service on the new cell. In this sense, the cell reselection procedure resembles the unannounced cell re-selection procedure.

Multi-slot packet data is a selling feature.

Voice and Data Support

The radio can alternate voice and packet data service. However, voice and data running in parallel are not supported. This behavior corresponds to Packet Data Type B - IP dual mode.

If the SwMI rejects the context activation due to **PD MS type not supported**, the radio reinitiates context activation indicating that supports **Type C**. It is done to accommodate legacy SwMIs that uses an older definition of these types.

The radio supports transmitting and receiving SDS on the packet data channel. Thus, these services may be conducted in parallel.

The radio can operate in one of the voice-data interaction modes.

Table 10: Voice-Data Interaction Modes

Voice-Data Interaction Mode	Description
Voice Only Mode	You have the option to select Voice Only mode , in which Packet Data service is disabled. If an external application attempts to start up in this mode, packet data registration for a wide link is rejected. If the packet data service is active when this mode is selected, the radio deactivates packet data. The PEI operates in the local mode only (data transfer between TE and MT).
Data Only Mode	You have the option to select Data only mode , in which normal voice calls are not permitted. Incoming non-emergency voice calls are rejected, and you cannot initiate non-emergency voice calls. Incoming and outgoing emergency calls are allowed.

Table continued...

Voice-Data Interaction Mode	Description
Voice and Data Mode	In Voice and Data mode any voice call activity that occurs during a data session takes priority over the packet data. Once a voice call has interrupted the data session, the PD session is suspended, until the voice activity has ended. Then the session is resumed. Voice priority mode is the default mode.

You can choose one of the interaction modes. The choice of interaction mode is stored in non-volatile memory and remembered at power up.

In **Voice and Data mode**, if the radio moves to the traffic channel due to the voice service, the radio terminates any active packet data transmission or reception. The data service is suspended. The data service resumes when the voice service ends.

The radio accepts any downlink SDS message received on the Packet Data Control Channel (PDCH). The radio can send uplink SDS messages on the PDCH.

The radio allows PEI, GPS, and WAP PD applications to activate and use the PD context simultaneously. The first application initiates PD context activation. The next PD context activation from another PD application results in sending a reply indicating that the PD context is active. When WAP, GPS, and PEI PD applications are using the active PD context, the radio can filter the downlink IP packets based on their TCP/UDP port.

- UDP packets addressed to the WAP port (configured in the codeplug) are routed to the WAP internal application.
- UDP packets addressed to the GPS port (configured in the codeplug) are routed to the GPS internal application.
- UDP packets not addressed to the WAP nor the GPS ports are routed to the PEI (using PPP).



Note: When activating another PD context on the radio, use the same settings in both PD contexts.

Packet Data IP Addressing

Table 11: Packet Data IP Addressing

Addressing Mode	Description
Wide IP Address	An IP address may be assigned to the terminal by the SwMI during the Packet Data context activation. When assigned, both Terminal Equipment and Mobile Terminal applications use this address as the source address in IP packets delivered to the infrastructure.
Local IP Address	By default both Terminal Equipment and the radio have their own IP addresses. Terminal Equipment and Mobile Terminal use these addresses for local datagram transmissions between Terminal Equipment and Mobile Terminal only and are not passed to the SwMI.
Static or Dynamic IP Address Assignment	The terminals support static and dynamic IP address assignment. The dynamic support is requested in the following situations: <ul style="list-style-type: none"> • Request a Dynamic IP Address is set to Dynamic and the PD Application Type is the radio internal PD application. • Request a Dynamic IP Address is set to Dynamic and the PD Application Type is a PEI PD application requesting dynamic IP address.

PD User Authentication

The PD user authentication is a method of authenticating the Terminal Equipment user before allowing the packet data link activation. A PD Authentication server connected to the SwMI performs the actual authentication. The terminal only sends the messages between the Terminal Equipment and the SwMI. In the wide mode, the terminal offers PPP user authentication between Mobile Terminal and Terminal Equipment using Password Authentication Protocol (PAP) or Challenge Handshake Authentication Protocol (CHAP), before the IP link is established. The terminal always attempts to negotiate usage of the CHAP method. However, the radio agrees to use PAP, when the Terminal Equipment application insists. If the terminal does not require PD user authentication, it operates without any user authentication. However, if the terminal requires the PD user authentication, it rejects the Packet Data Protocol (PDP) context activation.



Note: If the SwMI does not agree for the authentication method (for example, PAP), the SwMI can reject it.

TETRA Network Protocol 1

TETRA Network Protocol type 1 (TNP1) is a bridge protocol based on the TETRA layer 3 over the air protocol. The TNP1 supports all TETRA dispatch functionality.

In the TMO, the TNP1 specifies a protocol for use over the PEI, that allows terminal equipment (TE) to have control over the TETRA services: mobility management, call control, short data service, and supplementary services: send GPS reports, software information and battery state information. In addition, commands to access the radio configuration and storage parameters are available.

The radio supports TETRA standard packet data using the IP network layer protocol.

The radio can operate both on the single slot packet data channel and the multi-slot packet data channel.

Packet data applications reside internally, for example: GPS reports, WAP, or in an external device connected to the 8-wire RS232 data port on the radio. Communication to the external device is initialized using AT commands.

The system provides point to point IP connectivity allowing the following datagram exchanges:

- Radio \longleftrightarrow External Equipment (TE) (for example PC).
- External Equipment (TE) \longleftrightarrow Network (through radio).

The radio supports IP version 4 packet.

TNP1 services can use one of two PPP methods to connect from the terminal equipment to the radio, local mode, and wide mode. The TNP1 should be used in wide-mode wherever possible, to allow the parallel operation of TNP1-SDS services and packet data services over a common PPP link.

If the transmit inhibit is entered, the radio drops the wide mode connection, thus the PEI goes back to AT mode. Then the TNP1 client detects this change and reinitiates the PPP session in local mode.

The radio disables the TNP1 session while being in the DMO.

AT commands are used to initiate the PPP service for TNP1 to operate. Once the PPP session is running all AT commands are blocked. When the PPP session is closed, AT commands are available.

TNP1 IP Addressing

Table 12: TNP1 IP Addressing

Addressing Mode	Description
Wide Mode	All TNP1 services are available including packet data transfer towards the SwMI. The address used is the dynamic address MS IP or configured statically.
Local Mode	All TNP1 services are available except packet data transfer. The addresses used are the two static addresses TE IP: 10.0.0.101 and MT IP: 10.0.0.100.
Port Addressing	The radio uses a fixed port address for reception and transmission of TNP1 packets. The port number is 4024.

Mobility Services

Following is the description of the Mobility Services.

Main Control Channel Frequencies

The radio can find a wide range of main control channels. The radio maintains stored lists of carrier frequencies which are scanned in order.

- 1 A dynamic list of up to 32 discrete entries maintained only by the radio software.
- 2 A static list of up to 32 discrete frequencies specified by the operator that can be preprovisioned. The system operator can modify this list using the programming tool.
- 3 A frequency range specification, using a specific offset, that can be preprogrammed in the factory. The system operator can modify this range using the programming tool. Then the radio scans all frequencies in 25 kHz intervals in the specified range.
- 4 An additional frequency range specification. Having two separate range specifications allows for two non-contiguous blocks of frequencies or two different offsets.

Control Channel Selection

Each TDMA frame on a given carrier is comprised of four time slots, of which any can be used as a physical channel. The following types of physical channels are available:

- Traffic physical (TP) channel — used primarily for circuit call traffic.
- Control physical (CP) channel — dedicated only for signaling.
- Packed Data Control (PDCH) channel — dedicated for Packet Data traffic.
- Unallocated physical (UP) channel.

The following types of control channels are available:

- Main Control Channel (MCCH) — occupies the first slot of the main carrier.
- Secondary Control Channel (SCCH) — can be used to extend Control Channel capacity.

The following types of SCCH are available:

- Common SCCH
- Assigned SCCH

In addition to the MCCH, a cell can have up to three common SCCHs, which could occupy slots 2, 3 and 4 in the main carrier. This solution provides the ability to distribute the radio population among up to four channels and so to increase Control Channel capacity (at the expense of traffic channel capacity).

Until having received a specific parameter on a cell, the radio uses the MCCH. When the signal is received, each radio maps itself to a particular common SCCH, and that SCCH operates as the MCCH for the radio.

SCCH is a selling feature.

Multi-System Operation

The radio holds a list of up to 100 allowed network identities – Mobile Country Code (MCC)/Mobile Network Code (MNC) combinations, that are considered friendly networks. The first network in this list must be the radio home network. Each network can have an associated name that can indicate to the user which network it is. The radio can perform initial cell selection and registration on these networks and only these networks. Registration on any of these networks is performed using the radio ISSI and without migration signaling. The same ISSI is used on all networks. You can limit registration to the home network only, or to a selected network only, and to ignore the other allowed networks.

In case the migration defined by ETSI standard is NOT supported by the BTS, multi-system operation is only supported as follows:

You can change the network mode using the MMI. A top-level menu item called **Networks Sel** allows choosing between **Home Only**, **Select Net** and **Any Net**. If the radio chooses a network different from the current one, the radio forces initial cell selection to find a cell that belongs to the home or the selected network. In the selected network option, a list of network names (where each network name corresponds to one of the MNIs in the list) is displayed. The network names are provisioned in the radio as part of provisioning of the MNI list. The network alias or MNI of the current network is displayed on the first line of the idle display.

Home Only

In this mode the radio recognizes only the first system in the allowed list. As a result, the radio registers only on its home network, even if a foreign network is in range and is found first.

Select Network (Select Net)

In this mode the radio recognizes only the system you selected in the list of allowed systems. As the result, the radio registers only on this selected network, even if another network is in range and is found first.

Any Network (Any Net)

In this mode radio selects the network automatically where the home network is not available. The radio registers to any network that it finds that is already programmed into its codeplug list of networks, i.e. no user manual selection is required. Network selection to another network is only performed at initial cell selection following a link fail and then only if the home network is not available. The radio uses its own ISSI.

The radio operates in all networks as it does in its home network. All calls are placed using SSI addresses, and it is the SwMI responsibility to reject calls for subscribers or groups that cannot be reached in the local system.



Note: The telephony gateway interprets telephone numbers with the country code of the local country. For example, if you dial the number 01256-48-4566 in the UK, it is treated as if you dialed +44-1256-48-4566.

For description of other migrating modes used when migration is supported by the BTS, refer to Air Interface Migration and Dynamic Air Interface Migration sections.

Registration

On camping on a cell, the radio sends a registration request PDU to the SwMI, which includes a request to attach to the selected talkgroup.

If the registration and attachment succeeded, the radio begins normal operation on the cell. If the registration attempt times out, or the SwMI rejects the registration for a temporary reason, another registration attempt is made. If both attempts fail, the radio attempts to camp on a different cell.

If the SwMI denies the registration request due to the location area rejection, the radio does not attempt to register again at this cell until the next power-on. The radio supports the modification of its subscriber class on receipt of a new subscriber class from the SwMI in the registration acknowledgment PDU. This subscriber class is used until turning off the radio or next ITSI attach.

The radio does not send registration signaling when one of the following occurs:

- Roaming and registration fail before the radio receives the random access acknowledgment and the radio goes back to the last serving cell.
- The radio discovers a link failure on the serving cell, the link failure is shorter than the predefined timer and the radio is not in the transmit inhibit mode.
- The radio discovers a link failure on the serving cell and is in the transmit inhibit mode. In this case the radio always goes back to the serving cell without registration and stays in the transmit inhibit mode until the mode is turned off.



Note: When two or more scenarios occur at the same time, the radio registers with signaling.

If the radio discovers a link failure on the serving cell, a specific timer starts counting. If the link failure remains after the timer expires, then the radio acts as during a normal link failure. If the link failure ends before timer expires, then the radio goes back to the serving cell without registration. This mechanism ensures that unnecessary registration is avoided.

When a radio is out of the serving cell range for a period shorter than configured in the codeplug, then the radio does not perform the registration on going back in the range.

Call Roaming

The radio continually monitors neighbor cells and scans the highest ranked neighbor cell. When the state of the highest ranked neighbor cell is sufficiently better than the serving cell, or when the radio has lost the serving cell, the radio employs cell reselection procedures using the following methods:

- If not in a call — undeclared cell reselection.
- If in a call and not transmitting or link failure occurs — unannounced cell reselection.
- If transmitting in a call, and a neighbor has been scanned, and the cells are synchronized — announced type-1 or type-2 cell reselection.
- If transmitting in a call and no neighbor has been scanned or the cells are not synchronized — announced type-3 cell reselection.

For compatibility with systems that do not support type-1 or type-2 cell reselection, the radio can be provisioned to never perform these types of reselections.

The radio decides on the need for cell reselection, based on comparison of the signal strength and the service level between the serving cell and neighbor cells. The service level criteria are based on the following criteria listed in priority order:

- 1 System Wide Services available (Local/Wide Trunking)
- 2 Valid/Invalid Subscriber Class
- 3 Relinquishing criteria
- 4 Congestion level
- 5 Security Class
- 6 Subscriber Class
- 7 Home Location Area (Home Location area)
- 8 LA Boundary
- 9 Cell Load

The radio prefers a cell that has a higher service level to one with a lower service level. If the radio is operating on a serving cell that has a lower service level than a neighbor cell, the radio roams to the neighbor, even during a call.

During network reconfiguration, a significant number of radios registered on one cell may roam. This roaming can cause major congestion on specific cells. In order to avoid the congestion on control channels for the specific cells, the specified radios roaming should be distributed in time.

As the operation cannot be performed immediately for all the radios, some of the radios must wait longer to roam. The time cannot be programmed not to cause any of the radios to have inferior roaming capabilities. Thus the roaming time for the radios is randomized.

The randomization means that after roaming scenario starts, a radio is not sending registration parameters to other cells at once but waits random time before sending registration PDUs to other cells. Link failures and other related scenarios are not randomized not to cause any unwanted delays in restoring the link.

Seamless Handover

Seamless handover eliminates voice interruption during calls by enabling the radio to roam faster between cells while transmitting. Faster roaming is possible because the radio asks its serving cell to perform the reselection and the SwMI performs all of the roaming signaling. The radio then moves straight to the traffic channel on the new cell and continues the call without call restoration.

Air Interface Migration

The Air Interface Migration (AIM) feature enables the radio to migrate to a foreign SwMI, that is, the radio registration in a foreign SwMI is allowed. The AIM also enables the radio to attach the groups in a foreign SwMI and to make and receive calls and SDS.

The AIM services cover individual call, group call and individually addressed SDS or Status. In order to receive group calls or group addressed SDS and Status from a group of the current network, the radio has to attach the nominated group. The radio cannot migrate to a foreign network while it is in an active call. The radio also cannot attach a foreign group on the current network hence no group-addressed status/SDS messages can be sent to home network of the migrated radio. After migrating the radio is in the Clear Mode.

When AIM feature is enabled the radio selects the network in the **Foreign Net** mode (selectable in the radio MMI).

Foreign Network (Foreign Net)

In this mode radio selects the network automatically where the home network is not available. The radio registers to any network that it finds that is already programmed into its codeplug list of networks, i.e. no user manual selection is required. Network selection to another network is only performed at initial cell selection following a link fail and then only if the home network is not available. The radio uses Visiting Short Subscriber Identity (VSSI).

AIM, DAIM and Any Networks features are mutually exclusive.

This is a selling feature.

Dynamic Air Interface Migration

The Dynamic Air Interface Migration feature offers users a quick and easy way to switch between networks. Depending on that setting, every time a radio is powered up or a talkgroup is changed, it automatically roams to the assigned network. If a talkgroup has no particular network assigned, the radio stays on the current network.

This feature consist of these major functionalities:

- It allows your radio to dynamically select the appropriate network after your radio is powered up.
- If you change talkgroup to the one from a different network, radio automatically migrates to this network (in this feature it is possible to assign network to particular talkgroup in the codeplug). It gives you an option to automatically migrate to a network which is available in the region (network needs to be first pre-configured in the codeplug). It is useful in case of loosing signal from dynamically selected network as the radio attempts to establish communication with any available network.

This feature is useful where quick switching between networks is required, for example when entering a building that uses its own infrastructure.

When DAIM feature is enabled the user has these selectable options:

Migrate to

In this mode the radio user selects the network manually. Once network is selected terminal performs migration as to the foreign SwMI. If you change talkgroup to the one from a different network, radio automatically migrates to this network.

Auto

In this mode the radio selects the network automatically.

After migrating the radio is in the Clear Mode. AIM, DAIM and Any Networks features are mutually exclusive.

Any Networks

This feature allows to use the radio on any network that was pre-configured in that radio, like it was its Home network. This is useful when the radio loses its Home network coverage, but is within coverage of another network (for example, if a radio travels between different locations). Note that calls between networks are not possible.



Note: Air Interface Encryption services are not available when roaming to a different (not Home) network.

Dynamic Air Interface Migration and Any Networks features are mutually exclusive.

This is a selling feature.

Congested Cell Handling

This feature is used only during initial registration and when roaming between sites. It is not used when camped on a site that has become busy or congested due to no free traffic channel to make or receive calls.

When the cell that the terminal is trying to register is congested, a special level-based algorithm is in the place. Depending on the level of congestion the terminal is waiting for the registration or is rejected on that cell.

The terminal recognizes whether the cell is congested (Control Channel Congestion). The terminal tries to roam to not congested cells first, ranking congested ones as secondary. The cell congestion is one of the service level criteria.

The following cells are never marked as congested.

- Last suitable cell — if there are no other suitable cells (during roaming or initial cell selection).
- Serving cell.

The feature is configurable using the CPS.

Subscriber Class

When the radio powers up, or whenever it performs registration or roaming, it always uses its provisioned Subscriber Class (SC).

When the radio registers on a cell that does not support any of its SCs, it is active only in services that have the emergency priority.

Whenever the radio SC does not match the cell SC (the feature is configurable using the CPS), it either uses normal ranking procedures (see section [Call Roaming on page 64](#)), or does not roam to the cell at all.

Subscriber Class by Talkgroup

The Subscriber Class by Talkgroup feature forces all the radios attached to the same talkgroup to have the same Subscriber Class.

The Subscriber Class by Group feature helps to avoid issues as presented in the following scenarios:

- Preserving traffic channel capacity. For two cells having the same coverage and placed together to multiply traffic capacity a number of radios is attached to Talkgroup 1 on the first cell and only one radio is attached to Talkgroup 1 on the second cell. A group call uses two traffic channels (one on the first cell and one on the second). In this scenario, multiplying traffic capacity would not work without the feature. However, as radios on the same talkgroup are forced (by Subscriber Class mismatch) to roam to one cell, all the radios should use only the first cell.
- Spreading radios population across cells and prohibit them from roaming. Many radios used on a small area with multiple BTS coverage causes huge roaming traffic. A congestion occurs and as a result you would not be able to communicate. However with the feature, radios do not roam to a cell with mismatched Subscriber Class, what stops the roaming traffic.

A radio Subscriber Class changes when the user changes between talkgroups which are assigned to another Subscriber Class.

Up to 16 Subscriber Classes can be configured (in the CPS) and talkgroups assigned to them. The assignment is carried out by talkgroup GSSI or by folder (except Favorite) which the talkgroup was chosen from.

Talkgroup may be assigned to more than one Subscriber Class (either by folder or Talkgroup range). The first assigned Subscriber Class is used. Upon receiving Subscriber Class from the SwMI radios change their Subscriber Class to the received one. The Subscriber Class received from the SwMI over the air has always higher priority than Subscriber Class by Group. If a radio already uses the same Subscriber Class as the one received from the SwMI, the current Subscriber Class is not changed. On powering on, the radio is set to the default Subscriber Class or Subscriber Class assigned to an attached talkgroup.

Favorite folders cannot be assigned to any Subscriber Class.

Super Groups are treated as scanned groups and Subscriber Class by Talkgroup feature does not apply to them.

Subscriber Class by Talkgroup is a selling feature.

Local Site Trunking

Local Site Trunking (LST) is a feature enabling a base station to operate stand-alone. The base station may enter the mode when the link from the local cell to the central switch has gone down. The radio limits functionality when the cell is in this mode.



Note: Whether a radio can register on cells in LST depends on the codeplug settings.

If system broadcasts indicate that system-wide services are not available (LST) on a cell, the radio registers on this cell only if there are no system-wide cells available.

When the radio is operating on an LST cell, the radio may prevent you from invoking the following services (depends on infrastructure settings):

- Private call
- Phone call
- PABX call
- Packet data
- SDS data

Depending on the codeplug configuration, the radio may indicate entering the LST with the following notifications:

- Visible and audible
- Visible
- Audible
- None

To avoid unnecessary roaming and reduce congestion, Local Site Trunking Ignoring feature can be enabled. When Local Site Trunking Ignoring feature is enabled, the radio will temporarily ignore the LST/WST parameter when

selecting a site. However, the radio will still take other parameters (such as the cell's RSSI level) into consideration when deciding on roaming.

Local Site Trunking Ignoring is a selling feature.

Supplementary Services

Following is the description of the TETRA Supplementary Services (SS) that the radio supports in the TMO.

Dynamic Group Number Assignment

The radio supports dynamic addition and removal of talkgroups in its talkgroup list through TETRA Dynamic Group Number Assignment (DGNA) and De-assignment signaling (SS-DGNA).

The radio responds to DGNA directed to it or to DGNA directed to a group the radio is attached to.

When a dynamic group number assignment to add a new talkgroup is received, the radio adds the group in the first available spot in the talkgroup list in the codeplug. Then you can scroll to the talkgroup to select the group. The codeplug determines which DGNA operations are allowed for a group.

Depending on the group type the following is allowed:

- Static – only selection is allowed.
- Semi-Static – selection and reassignment are allowed.
- Dynamic – selection, deassignment, and reassignment are allowed.

The groups can be assigned as not attached, attached as scanned or attached as selected. Assignment of the group through DGNA with attached as selected makes it the selected group of the radio. If the group is assigned with attached as scanned, if it is not already in the currently active scan list, the radio adds this group to a SwMI Controlled scan list and begins monitoring downlink signaling addressed to this group. The SwMI controlled list holds up to ten groups, and the radio monitors these groups as well as groups in the user scan list.

If the talkgroup list is full when adding a new group, the radio rejects the assignment operation. If the SwMI controlled list is full and the assignment is with attached as scanned, the attachment is rejected.

When a talkgroup de-assignment is received, depending on the codeplug settings (DGNA Operations field in the Talkgroup List) the radio behavior is as follows:

- If the DGNA Operations field is set to Static or Semi-Static, the radio;
 - leaves the talkgroup and the parameters assignments to folders unchanged.
 - sends an acknowledgment PDU with notification the group definition has been removed.
- If the DGNA Operations field is set to Dynamic or if the group is not in the talkgroup list, the radio;
 - removes the talkgroup from the talkgroup list (if the talkgroup is in the list).
 - removes all the occurrences of the talkgroup from the folder list.
 - sends an acknowledgment PDU with notification the group definition has been removed (also if the talkgroup has been deleted, or the talkgroup does not exist in the radio).

In all the cases, the talkgroup is removed from all the scan lists as no matter if they are active or inactive.

If the de-assignment is for the selected group, depending on the service provider settings, the radio;

- notifies that there is no group attached (when in the group mode), and does not attach to another talkgroup automatically.
- attaches to the previously selected talkgroup (talkgroup it was attached to before the DGNA being assigned). If the previous selected group is not present then the radio shows that there is no group attached and displays "No Group".
- attaches to a default talkgroup configured by the service provider. If the default talkgroup is unavailable (it was deleted), the radio enters the "No Group" state.

At each talkgroup change, an appropriate notification is shown on the display.

If the de-assignment is for an announcement group, the talkgroup is removed from the talkgroup list. Additionally, all the groups that are associated with this announcement group do not have an associated announcement group. If the currently selected talkgroup is associated with this announcement group, the radio stops scanning the associated announcement group.

When the DGNA operation is successful, if the radio is provisioned for DGNA user notification, you are notified about the operation. For example group added, group deleted. The notification is displayed until you confirm the operation. In case you receive a call, the message continues displaying until you confirm it.

On viewing an assigned talkgroup notification, the radio provides the ability for the user to make that group to be a selected group.

The radio supports the reception of a DGNA Assignment that is addressed to its selected talkgroup as a supergroup of the selected group. All signaling addressed to the supergroup is monitored in addition to signaling addressed to the selected group, any announcement or associated groups, and groups in the active scan lists.

When the selected group is unselected, the radio ceases processing signaling to the supergroup that was associated with that selected group.

The radio receives the lifetime of the supergroup as part of the assignment signaling. If a subsequent assignment to the same group is not received within that lifetime, the radio ceases monitoring that supergroup.

The radio also supports supergroups of scanned groups, such that a group addressed DGNA assignment received on one of the user scan group addresses causes the radio to monitor all signaling addressed to that supergroup as long as the scan group is being monitored, and as long as the supergroup lifetime lasts.

The following DGNA functionalities are not supported:

- Call-related DGNA.
- Functionality of the authorized user.
- Network authentication before accepting DGNA.

Ambience Listening

The Ambience Listening (AL) feature allows a console operator or dispatcher to monitor audio activity in the vicinity of a specific radio without giving any indication to the affected radio.

When the radio receives a call setup message with an AL call, the radio accepts the call. Then the radio opens the microphone, and begins transmitting without showing any indication of the call. Call acceptance and rejection while active in another call follows the PPC rules.

The radio imposes no time limit on the transmission. The radio continues to transmit until the SwMI ends the call or the user performs an action that releases the call. If the user attempts to start a service while the AL call is in progress, the radio disconnects the call and initiates the requested service. The radio allows performing actions that can be performed without releasing the AL call. These actions include access of most menu items, activating, deactivating scan lists, and changing talkgroups. When changing talkgroups, the radio appears as if it is performing an attachment. The attachment appears to be successful, but the actual attachment signaling is performed only after the AL call terminates. When performing the attachment after the call, no indication is shown to the user unless the attachment fails. If you attempt to power down the radio in the active Ambience Listening call, the radio enters Pseudo Power-Off state.

Pseudo Power-Off

If you attempt to power down the radio in the active Ambience Listening call, the radio appears to turn off. However, it remains fully operational from Layer-3 and below. The radio has a blank screen, and all LEDs are turned off.

When the AL call ends in this pseudo power-off state, the radio automatically turns off.

If you attempt to power up the radio from the pseudo power-off state, the radio acts as if it is really powering up.

Preemptive Priority Call

If during a call, a call setup is received for a call with higher priority than the present call, and the new call priority is Preemptive Priority 3 (value 14 in the codeplug) or Preemptive Priority 4 – Emergency (15), the radio disconnects from the present call and joins the new high priority call.

If the call priority of the new call is Preemptive Priority 1 (12) or Preemptive Priority 2 (13), depending on configuration the radio either accepts or rejects the new call.

When the new call is accepted, a special tone is played, and you are notified of the high priority call.

When you initiate a private call and you receive a rejection with the reason **Called party busy**, you have the option to interrupt the existing call or initiate a new call. However, this time the call is initiated with the preemptive priority.

Transmit Inhibit Mode

The Transmit Inhibit Mode is a mode in which the radio sends no radio transmissions. It is recommended to activate the mode in RF sensitive areas, for example hospitals, airplanes, where safety can be jeopardized due to transmission radiation.

To activate, select MENU → **More . . .** → **Networks** → **TXI Mode** → **Activate**.

In this mode, the radio does not transmit under any circumstances except for the Emergency Calls. All the functions and keys which cause transmission, for example registration to the network, changing talkgroup or folder, sending SDS messages, or pressing the PTT button are disabled. Any transmission trial causes the radio to display **Not Allowed In TXI Mode** notification and to play a tone.

Your radio can still receive:

- Group calls.
- Messages — stored in the **Inbox**.
- Private call attempts — stored in the **Missed Calls** list, without the option to respond.

When no danger to safety exists anymore (for example, you leave the RF sensitive area), you can deactivate the Transmit Inhibit Mode and the radio returns to standard operation.

You can deactivate the mode by selecting MENU → **More . . .** → **Networks** → **TXI Mode** → **Deactivate**, pressing One-Touch button, or implicitly when initiating an Emergency Call.



Note: RF Transmissions from the radio are prevented under the following conditions:

- TXI Mode is activated.
- Battery is removed.
- The radio is turned off.

On entering or exiting the transmit inhibit mode, when the radio is camped on a cell, it sends a specially designated SDS status message. This SDS message indicates to the SwMI that the radio is entering or exiting transmit inhibit mode.

Mobility procedures that do not require the radio to send an uplink transmission are performed except for cell reselection.

In transmit inhibit mode the radio joins group calls for any group that the radio is monitoring, but the transmitting on that call is still prohibited.

The radio also displays any incoming SDS messages to the user. The missed call feature is active in the transmit inhibit mode and allows checking what calls were missed. However, the radio attempts to prevent call setup retransmission from being recorded as separate calls.

If you initiate an emergency call, the radio immediately leaves transmit inhibit mode and attempts to start the emergency call if the radio is in service.

If the radio is turned off in the transmit inhibit mode, on turning on the radio asks whether to exit the transmit inhibit mode. If you choose **No**, the radio turns off.

Calling Line Identification Presentation

If the radio is provisioned with the calling line identification presentation (CLIP), the calling party number is transported as part of the incoming call setup signaling. Also the calling party number is shown on the radio display. If the calling party ID is programmed in the radio with a corresponding name, the name is displayed in addition to the number.



Note: The number sent by the SwMI is expected to be in a form that can be used to call back the calling party at any other time. Thus, for instance, the number can be stored in the address book.

If the calling party number is not present in the incoming call setup signaling, a blank line is displayed in its place.

Talking Party Identification

The PDUs and facility elements for these TETRA Supplementary Services are not supported. However, identification presentation functionality is supported in most cases using the information found in the call setup messages.

DTMF Overdial

This supplementary service allows the radio to send DTMF tones to both internal and the external network during the call (conversation). It is only possible to send DTMFs when in full duplex call. This can be disabled in the codeplug (enabled by default).

Universal Time Display

The radio can present time information to the user. The time is derived from an internal clock. The radio maintains the clock both when the radio is powered on and powered off.



Note: If the power is lost, for example due to the flat battery, the internal clock is not maintained.

In order to ensure the time displayed is accurate, the time is displayed only if within the last 48 hours either of the following events have occurred:

- The radio has received a network time update from the system.
- You have manually updated the time.

Also, as the internal clock is not maintained after a power loss event, the time is not displayed until either these events occur.

The feature is enabled or disabled and the default configuration can be set for the radio using the CPS or MMI.

The radio display supports the following:

- Twenty-four-hour and twelve-hour formats.
- DD/MM/YY, MM/DD/YY, DD-MON-YY and YY/MM/DD date formats.

You can change the time and configuration information through the MMI (depending on the codeplug settings). Depending on configuration, system broadcast information can have higher priority than data entered manually. Thus time, date, and offset information entered from the MMI is overwritten, when data is received from the SwMI. The radio provides user indications upon crossing to another time zone, when a new MCC broadcast received.

DMO Gateway and Repeater Communication

The radio provides the capability of communicating in DMO mode with a TMO group via the IOP certified gateways.

A DMO repeater re-transmits information received from one DMO radio to other DMO radios over the DMO air interface.

For each DMO talkgroup, the radio allows operating in one of the following modes:

Radio to radio only

The radio initiates calls only on a talkgroup directly and not through a gateway or repeater.

Specific gateway

The radio can initiate calls on a talkgroup directly or through a specific gateway address that is specified for a talkgroup. The gateway address can be edited through the radio MMI.

Auto gateway

The radio can initiate calls on the selected talkgroup directly with another radio or through any available gateway that is detected as present.

Repeater

The talkgroup links to a DMO repeater.

Specific gateway and repeater

The radio uses only the gateway with the specified gateway address for the talkgroup and/or a DMO repeater.

Automatic gateway and repeater

The radio uses the first available gateway for a talkgroup and/or a DMO repeater. If either specific gateway or auto gateway mode is chosen, and a suitable gateway is found, all outgoing calls are placed through the gateway. If a suitable gateway is not found, or a call setup through the gateway fails, the radio attempts to set up the call directly.

When operating on a gateway and/or repeater, the radio indicates the communication mode.

Communication through Repeaters

Radios that are out of range and cannot communicate directly one with another in DMO Mode can do it through the repeater. The repeater is a radio that repeats all communication on a chosen channel, and as a result increases radios' DMO range.

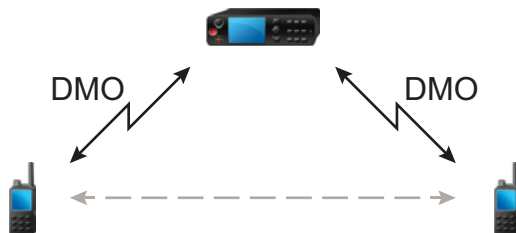

When the radio connects to a repeater, it plays a tone, displays the **Repeater available** message, and shows an appropriate icon. When the radio loses connection with the repeater, it plays a tone, displays the **Repeater not available** message, and the repeater icon is blinking. Messages and sounds are configured by the service provider.

Communication through Gateways

Gateway provides connectivity between radios operating in DMO Mode and the TETRA network, so that the DMO radios can communicate with the TMO radios.

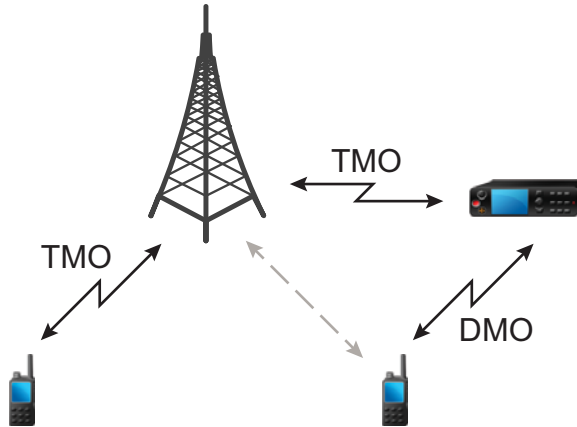

When the radio connects to a gateway, it plays a tone, displays the **Gateway available** message and shows an appropriate icon. When the radio loses connection with the gateway, it plays a tone, displays the **Gateway not available** message, and the gateway icon is blinking. Messages and sounds are configured by the service provider.

SDS Remote Control

The SDS remote control feature enables controlling a radio through Air Interface using SDS-TL bearer service. A controlling terminal (for instance, a controlling radio or SwMI controlling terminal) sends the SDS remote control messages with AT commands to be executed by the radio.

Figure 7: SDS remote Control Overview

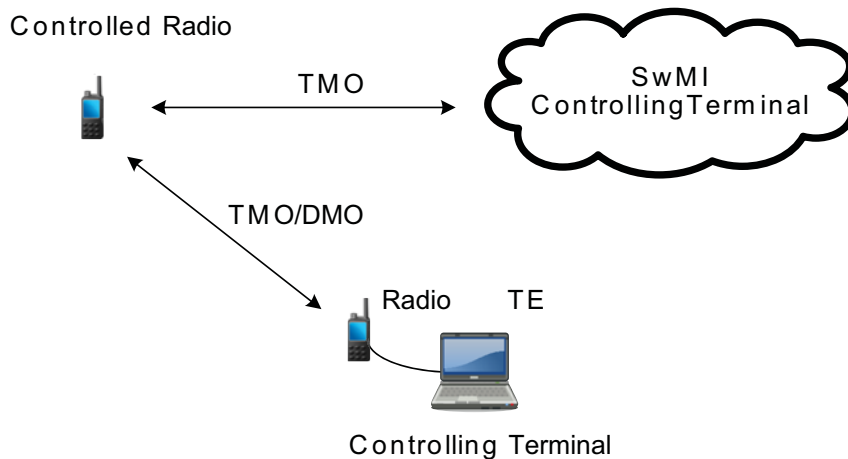

The SDS remote control functionality works in both TMO and DMO and the remote control PDUs are sent using terminal equipment (TE).

You can use the feature only after a successful authorization, which requires entering a valid remote control PIN number.

The remote control messages can be sent to a group or individual radios.

A controlled radio receives over the air control information using SDS type 4 with TL on the specific PID number defined in the codeplug. If the received control message is originated from one of ISSIs present on the radio authorized ISSI list, the radio executes received command and sends a response.

If configured by service provider upon the reception of SDS Remote Control Service (AT command) request, the radio gives an audio-visual notification.

The service provider has two options: **Limited SDS RC** and **Full SDS RC** modes.

The SDS remote control in the Limited SDS RC enables the following:

- Switching between TMO/DMO modes (read, change, notify) for individual radio and group (using +CTOM AT command).
- Selecting a talkgroup (read, change, notify) for individual radio and group (using +CTGS AT command).
- Reading and setting the scanning state (using +CTSCAN AT command).
- Collecting Network Information from individual radio (Network Registration Status and Cell Signal Quality using respectively the +CREG and +CSQ AT commands).
- Reading individual radio GPS position (using +GPSPOS AT command).
- Setting volume level for individual MT (using +CLVL AT command).
- Rebooting the radio (using R AT command).
- Terminating a call (using H AT command).
- Call forwarding (using +MCCFWD AT command).

The SDS remote control in the Full SDS RC enables to use most of the AT Commands. Refer to the *AT Commands Programmer's Guide* to see which are not supported.

This is a selling feature.

Call-Out

A call-out is an alert sent to one or many recipients when an incident requires immediate attention. The call-out message can include an instruction to use a different talkgroup for the duration of the call-out or remain on the attached talkgroup.

There are four types of Call-Out alerts:

- Normal
- Storm Plan
- Fallback Mode
- Test Call-Out

Only the emergency mode has higher priority than the call-out. When you receive the alert, the following responses are available.

- **Accept** — additional information from the dispatcher is displayed.
- **Stand by** — voice and message communication is the same as for **Accept**.
- **Reject** — display returns to the home display and the talkgroup is set to the one before the call-out.

Call-out alert can be addressed as follows:

- ISSI — an individual.
- GSSI — a group of recipients.

All incoming and outgoing call-out messages are stored in **CO Box** (Call-Out Box) and can be managed through the MMI. There is a two-level structure for the alerts. First level is the main alert list, and the second one are all the messages associated with the alerts. Both lists are displayed chronologically with the newest on top. The capacity of the **CO Box** is ten call-out alerts and 100 messages (incoming/outgoing). It has also the overwrite policy which deletes the oldest one upon receipt of a new call-out message. When a new call-out arrives, the new call-out overrides the old call-out (even if it has not been responded). An ongoing call-out overrides the old one in any phase of the call-out alert.

In normal mode, you can browse the **CO Box** and read all the call-out messages. In the call-out mode, you can only read the ongoing call-out messages.

The call-out service function in two main phases:

- 1 **Alert Phase** — you receive the alert with the associated messages that you can respond to. These messages provide all the important information about an incident. A special tone is played when the alert is coming in. The tone volume range is configured in the codeplug and cannot be adjusted through the MMI. The conditions for stopping this tone are configured in the codeplug (for example, upon pressing any key). Additionally, an ongoing alert tone is paused on incoming call-out group call. This alert is resumed once the call ends (if not stopped before).
- 2 **Information Phase** — you are in the call-out mode and you may receive more messages about the incident with the text or voice. You can also query for more information using the voice group call or the call-out text function which enables to send a text message to the dispatcher host application. The voice message can be sent with the high priority as a group call. You can answer back to the group or to the dispatcher using the voice group call. You may receive more info about the incident via either via subsequent text or voice messages

This is a selling feature.

Call-Out Interactions

When you receive a call-out alert while being in the emergency mode, the message is ignored.

In the transmit inhibit mode, you can receive call-out messages. However, you cannot respond until the transmit inhibit mode is deactivated. When you decide to leave the transmit inhibit mode after viewing the message, the radio prompts to accept, standby, or reject the call-out.

The call-out feature is not supported in DMO.

In the fallback mode (that is, when you are in the local site trunking) you can receive a call-out call. In such case the receiving radio enters the call-out fallback mode, which only includes voice communication. You can only clear the fallback mode manually.

The dispatcher can test the feature by using the call-out test. The radio displays then **Call-Out Test** and generates the alert tone. A soft key is available in the MMI with the label **Test OK**. After responding to it, the display returns to the previous mode.

Storm plan alert is a special case of call-out. This alert is sent out to the larger group of people. You can respond to it with any key stroke. After responding, you proceed to the information phase. The storm plan alert is sent several times to raise reliability.

Radio Messaging System

The Radio Messaging System (RMS) feature enables radios to receive and send RMS messages through the TETRA network using the Short Data Service (SDS) Transport Layer (TL).

Figure 8: Radio Messaging System Flow Model

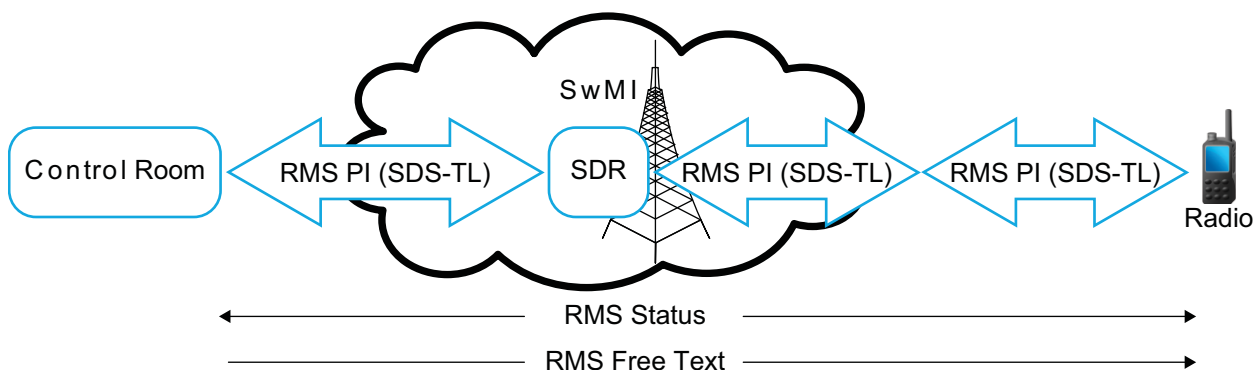

A Short Data Router (SDR) provides TETRA short data services between host applications connected to Dimetra Mobile Stations or between a host application connected to a Dimetra Mobile Station and a host application connected through the Dimetra Master Site. Furthermore the SDR provides TETRA short data services directly between two Dimetra Mobile Stations or directly between a Dimetra Mobile Station and a host application connected through the Dimetra Master Site.

To receive and send RMS messages, ensure that the RMS feature is enabled in the codeplug. The radio accepts received RMS messages only from the calling party address defined in the codeplug. Any outgoing RMS status is sent to the RMS status target address defined in the codeplug.

The RMS status is a bidirectional messaging (from the control room to a radio and conversely). Sending an RMS status is possible, where the RMS mode is enabled in the radio. In such case, the radio user can send one of ten predefined RMS statuses to an address predefined in the codeplug. You can select the particular RMS status using assigned one-touch buttons. A received RMS status is displayed in blue color on the idle display. The latest received or sent RMS status is kept on the idle display until the next power cycle.

The RMS free text is a unidirectional message (from the control room to a radio). Received RMS free texts are displayed in blue color on the idle display. The latest RMS free text is kept on the display (idle display) until the next power cycle.

Upon receiving the request, the radio sends the latest sent RMS status to the control room without any user interaction or notification.

Incoming and outgoing RMS statuses and RMS free text messages (with the exception for RMS status sent) are stored in the **RMS Box**. The **RMS Box** capacity is maximum ten entries for incoming and outgoing RMS messages. If the **RMS Box** is full, storing any new incoming or outgoing RMS message overwrites the oldest message (received or sent) in the **RMS Box**.

This is a selling feature.

GPS Location Service

The GPS Location Service feature uses information from Global Positioning System (GPS) satellites orbiting the Earth to determine the approximate geographical location of your radio.

The GPS Location Service availability, accuracy, and the position calculation time vary depending on the environment in which you use the radio. The GPS Location Service can assist your dispatcher or colleagues in many ways such as more efficient deployment of resources or locating your radio when you trigger your emergency service.

The radio can display the location information directly on the screen or send it over the air to your Dispatcher to display it in the control center. Check your radio configuration details with your service provider.



Important: Where the signals from satellites are not available, the GPS Location Service does not work. This situation usually happens when your radio cannot establish a view of a wide area of open sky, for example, when your GPS antenna is covered or facing the ground. Such situations include being:

- In underground locations
- Inside buildings, trains, or other covered vehicles
- Under any other metal or concrete roof or structure
- Near a powerful radio or television tower
- In extreme temperature outside the operating limits of your radio

Even if your location information can be calculated in such situations, it may take longer to do so. Therefore, in any emergency situation, always report your location to your dispatcher. Where adequate signals from multiple satellites are available, your GPS Location Service feature provides a location, most probably near to your actual location. For GPS feature performance, under ideal test conditions see Table “GPS Specification”

The radio can be triggered to send Location Reports in various circumstances, for example:

- Upon a request

- Entering Emergency Mode
- At specified time intervals
- At specified distance intervals

The Location Reports can be sent in two ways using:

- SDS
- Packet Data

If the Location Reports are sent over the Packet Data, a Packet Data icon is displayed when the message is being sent.

If the Location Reports are sent via SDS with User Defined Data Type-4 as a transport layer, either the ETSI Location Information Protocol (LIP) or Motorola Location Request/Response Protocol (LRRP) GPS Location Protocol is used. The LRRP GPS protocol either use SDS-TL (for added reliability) or Simple GPS with no SDS-TL (for saving air interface resources). GPS Protocol Identifiers are:

- LRRP SDS TL = 131
- LRRP Simple GPS = 3
- LIP GPS = 10

Location reports are sent in TMO and can also be provisioned to be sent in DMO. If the radio is provisioned to provide user indications, the feature operational status is indicated on the radio display. Also, if configured by service provider, the radio gives an audio-visual notification upon reception of LIP command.

Depending on the radio configuration, viewing the radio position and the status of the visible satellites is available. The position may consist of longitude and latitude, UK, or Irish grid coordinates. The GPS Location Service feature can be enabled or disabled as a whole using the CPS. It is possible to configure the feature parameters using the CPS, or over the air. The CPS configuration provides a default profile. The commands received over the air may overwrite the default profile configuration. The profile assigned to the radio determines when to send location data, what data to send with what accuracy and to what address. All data requests and configuration commands received over the air are checked to confirm they have come from a trusted source. Location reports are accepted only from authorized ISSIs or IPs, depending on the configured transport layer (SDS, Packet Data).



Note: Ensure the application receiving location messages uses valid addresses which are set up on radio as an authorised ISSI range. Otherwise the radio rejects all system GPS requests.

The radio supports GPS triggers functionalities (using LIP or LRRP) to report GPS positions when the radio meets a set of criteria. The following triggers, together with their specific parameters, can be set up by service provider:

Table 13: GPS Triggers

Trigger Type	Trigger Event
Power-up	Radio powers up in TMO.
Power-down	Radio powers down in TMO.
Emergency condition	Radio enters emergency operations.
Periodic	Given time interval after the last location report expires.
Moved	Radio position has changed by at least the distance defined (the radio checks the movement from the last known position at an interval).
TMO ON	Successful registration on entering TMO from DMO.
DMO ON	Before TMO deregistration, and before entering DMO.
Transmit Inhibit Mode ON	Radio is about to enter TXI.

Table continued...

Trigger Type	Trigger Event
Transmit Inhibit Mode OFF	Radio has successfully registered after leaving TXI.
Low battery	Radio detects its battery level has reached or fallen below the level specified by service provider.
Loss of GPS	Radio detects a loss of GPS for a minimum duration defined by service provider.
Recovery of GPS	Radio detects a recovery of GPS signal for a minimum duration defined by service provider.
Status entered	Radio sends a status defined in the CP for location reporting by pre-programming.
DCK Connected	Radio detects that a Car Kit has been connected.
DCK Disconnected	Radio detects that a connected Car Kit has now been disconnected.
GPS ON	Positioning device has been switched ON.
GPS OFF	Positioning device in the radio is about to be switched OFF.
Emergency Periodic Profile (LRRP only)	Radio is in emergency operation and given time interval after the last location report expires.

The GPS icon is displayed in the status area when GPS has a location fix. Optionally, your service provider may configure the radio to always display the GPS icon, even outside of GPS coverage or before the radio has acquired a location fix, i.e. right after being powered on. In this configuration, the GPS icon blinks until a location fix is acquired.

This is a selling feature.

GPS Military Grid Reference System

The Military Grid Reference System (MGRS) is the geocoordinate standard used by the military for locating points on Earth. The MGRS attempts to represent the entire surface of Earth on a worldwide grid. The grid is based on the UTM (Universe Transverse Mercator) between 80°S and 84°N latitudes and UPS (Universal Polar Stereographic) systems.

The UTM area is divided into 60 longitudinal strips, each 6° wide. The strips are numbered 1-60 beginning at the 180°-174° W (Zone 1) and increase to the East. Each strip (or Zone) is then divided (horizontally) into 8° latitude bands.



Note: An example of an MGRS coordinate would be **19TDJ3858897366**, which consists of:

- **19** is the UTM Zone Number
- **T** is the corresponding UTM latitude band letter
- **DJ** is the MGRS Grid Reference used to define the 100 km square within the UTM/UPS block. The columns A-Z (excluding "I" and "O"), like UTM, start at 180° and increase towards the East. Every three columns, the pattern repeats. Letters designating rows, increase towards the North. The letters cycle backwards through the alphabet in the southern hemisphere (towards the South):
 - **D** is the MGRS column letter
 - **J** is the MGRS row letter
- **38588** is the 5–digit MGRS Easting value. It represents the number of meters East of the origin (that is, southwest corner) of the 100 km square in which it is contained.
- **97366** is the 5–digit MGRS Northing value. It represents the number of meters North of the origin (that is, southwest corner) of the 100 km square in which it is contained.

MGRS Support feature can be programmed in CPS. The user can choose to display the GPS coordinates in MGRS format.

This is a selling feature.

GPS Different Location Displays

Table 14: Different Location Displays

Latitude / Longitude	UK Coordinates	Irish Coordinates	UTM Coordinates	MGRS Coordinates
Time	Time	Time	Time	Time
Latitude	2-Letter Code	1-Letter Code	3-Letter Code	3-Letter Code and 2-Letter Code
Longitude	Easting and Northing Coordinate	Easting and Northing Coordinate	Easting and Northing Coordinate	Easting and Northing Coordinate
Altitude	Altitude	Altitude	Altitude	Altitude
Satellites	Satellites	Satellites	Satellites	Satellites

- Time — indicates when the last time the location was calculated. The time is provided in Universal Time Coordinated.
- Letter Code — grid zone or square on the map for different coordinate standard
- Latitude — expressed in degrees, minutes, and seconds.
- Longitude — expressed in degrees, minutes, and seconds.
- Number of satellites — used to calculate the location. In general, more satellites make for better accuracy. The maximum is 12 satellites.
- Easting — refers to the eastward-measured distance expressed in meters.
- Northing — refers to the northward-measured distance expressed in meters.



Note: Skipping each digit of easting and northing coordinates decreases the accuracy by the factor of 10.

WAP

Wireless Application Protocol (WAP) is a standard for application layer network communications in a wireless communication environment such as TETRA network. The protocol is used to access the mobile web from a radio through a WAP browser.



Note: This is a selling feature.

WAP Browser

The Openwave Mobile Browser is a WAP-compliant user agent. The WAP browser provides all of the basic services of a computer-based web browser. Whenever any preemptive display interrupts the browser session, the browser needs manual reactivating to return. The WAP browser does not support right-to-left languages (as Arabic and Hebrew); English is used instead. For the content in these languages, the characters are not displayed.



Note: Depending on the radio configuration and the network conditions, the WAP browser may not display images properly (or may display them with a delay).

WAP Push

WAP push allows WAP content to be pushed to a radio. This push is carried out by sending a specially formatted (Push Access Protocol) XML document to the Push Proxy Gateway, that in turn forwards the document to the radio.

A WAP push message is an encoded message including a link to a WAP address. On receiving a WAP push, a WAP enabled radio automatically gives the option to access the WAP content. The implemented WAP push is compliant to WAP 2.0 standard.

The radio supports WAP 2.0 through a proxy only. Proxy-less connections are not supported.

This is a selling feature.

WAP Push Framework

A push operation in WAP is carried out by allowing a Push Initiator (PI) to transmit push content and delivery instructions to a Push Proxy Gateway (PPG). The PPG delivers the push content to the radio as per to the delivery instructions.

The PI is an application running on a web server and communicating with the PPG using the Push Access Protocol (PAP). The PPG uses the Push Over-The-Air (OTA) Protocol to deliver the push content to the radio.

Figure 9: Push Framework

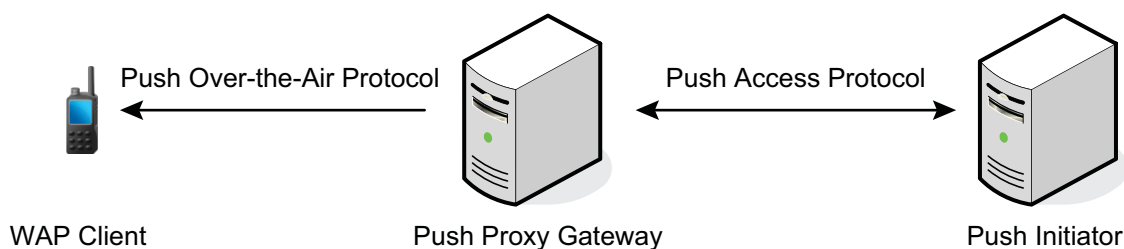

WAP Push Service Indication

The service indication (SI) presents a notification and an associated URL with a prompt to enter the URL on the radio display. The notification is then stored in the WAP box for subsequent presentation.

The SI can be valid only for a certain amount of time. After the specified time elapses the SI indicates void content. The author of an SI can set the expiration date and time, that is, when the SI is automatically deleted from a radio.

The service provider can remotely delete SIs that became invalid. The removal is carried out through sending a special SI to delete the invalid entity.

A new SI is indicated with a respective status icon, tone, and a pop-up. The pop-up occurrence depends on the SI priority (high and medium) and the radio conditions (for instance, if the radio is in a call the pop-up does not appear). Depending on the periodic alert feature availability, a notification of an unread SI can be indicated with periodic notification, similarly to an SDS message.

WAP Push Service Load

Service Loads (SL) differ from the Service Indications (SI) by the fact they do not prompt to enter the URL. Instead, the browser is automatically activated. The SL contains an URL indicating what service to load.

A new SL is indicated with a respective status icon, tone, and browser activation. The browser activation depends on the SL priority (high) and the radio conditions (for instance, if the radio is in a call, the browser does not display).

SL messages sent with urgency cache can be not indicated directly to the user. Such SL messages load content and store it in the cache (the process works in the background, only the PD icon is visible to the user).

Radio User Assignment and Radio User Identity

Radio User Assignment (RUA) and Radio User Identity (RUI) enables authentication for providing full access to the infrastructure and the physical radio.

Where the RUI feature is enabled, on logging on to the radio you enter your User ID with the PIN to check your identity. Only the successful logon provides the full access. A logon failure results in limited service.

Where also the RUA feature is enabled, after successful RUA/RUI authentication you are logged on to the physical radio. Thus, you can still be reached at your radio number.

You can differentiate the RUA/RUI state by the interface color. Blue for logged on and gray for logged off. No additional icon indicates whether you are logged on.

Besides the logged on off states, the radio can also be in the pseudo log on state indicated by the relevant icon.

The User ID is stored in the RUI List. To verify who is logged on to the radio, see the second line in the RUI list (the first line is **New User ID**).

RUA/RUI is a selling feature.

RUA/RUI Log On

You can log on yourself or the dispatcher can log you on. The feature must be enabled in the codeplug, by your service provider.

After turning on the radio, the infrastructure verifies a request from the radio and checks if it supports the RUA/RUI. When the infrastructure accepts RUA request, you are asked for RUI and RU-PIN. After providing correct information, a successful logon occurs and full access is granted for specified time.

When a RUI and/or RU-PIN are incorrect, a logon failure occurs. The infrastructure sends the RUA reject signal to the radio. If enabled in the codeplug, limited service access is granted.

When the dispatcher is sending the RUA accept signal to the radio with the time period that the full service is granted, then the successful book on occurs.

RUA/RUI Radio Behavior

When the radio is logged off and receives RUA accept from the infrastructure without sending logon information, it indicates book on with assigned logon period timer. The radio sends automatically book on response according to the terminal settings: **Book on Reject** — the radio rejects all the book on, **Book on Accept** — the radio accepts all the book on.

To log off, use the radio menu. The dispatcher has also the option to log you off using **Force Off** setting.

The pseudo log on is a state which occurs when the RUA/RUI authenticated radio goes to LST, or infrastructure accepts the logon with the empty granted assignment period. In this state, the radio has the full functionality available except some services as forwarding calls. This state is signalized with a specific icon.

The RUA/RUI feature is specified with the following timers:

- Logon Process Timer — defines the amount of time during which the radio awaits log on response from infrastructure.
- Time Out Warning Timer — defines the amount of time after which the radio displays the warning.
- Logon Period Timer — defines the amount of time during which the radio is logged on.

RUA/RUI Interactions

When you switch from TMO to DMO, the terminal logs off (depending on the codeplug settings). When you switch from DMO to TMO, the radio initiates the log on process.

You may be RUI-authenticated when out of coverage. In this situation, the radio is in pseudo logged on status. All the timers are the same as for the logged on user with the coverage. You may also be logged off when out of coverage. In this situation, the radio is provided with the limited service access. In both cases, if the radio is back in the coverage area and receives RUA request from SwMI, it prompts you to log on.

If during the emergency operations you receive the force-off, it logs you off without exiting the emergency operations. As long as the radio is in the emergency operations, the radio display does not indicate any change.

When the radio turns on in the LST, it prompts for the PIN. If the correct PIN is entered, the radio switches to the pseudo logged on state. When you move to the LST, the radio switches to pseudo logged on state. However, no prompt for the PIN occurs.

When you change to a different physical terminal, the store and forward report is routed to the radio where you are currently logged on. When the radio receives store and forward report, it does not display the report, as the reports have to match the sent SDS. If an SDS consumer report is requested, it is recommended that the receiver sends an explicit separate SDS message to confirm the message has been received and read. The report is stored together with the sent SDS in the **Outbox**, because of that when you log off, delete the messages from the **Outbox**. When you change to different physical radio, the previous permanent radio does not receive the report. The status of store and forward message in the **Outbox** cannot be updated.

Chapter 3

Man-Machine Interface

Controls, Indicators and Related Features

LED Indications

Table 15: LED Indications

Indication	Status
Solid green	In use
Blinking green	In service
Solid red	Out of service
Blinking red	Connecting to the network Entering DMO
Solid orange	Transmit inhibit in service Channel busy in DMO
Blinking orange	Incoming call
No indication	Idle Radio powered down

Controls and Indicators

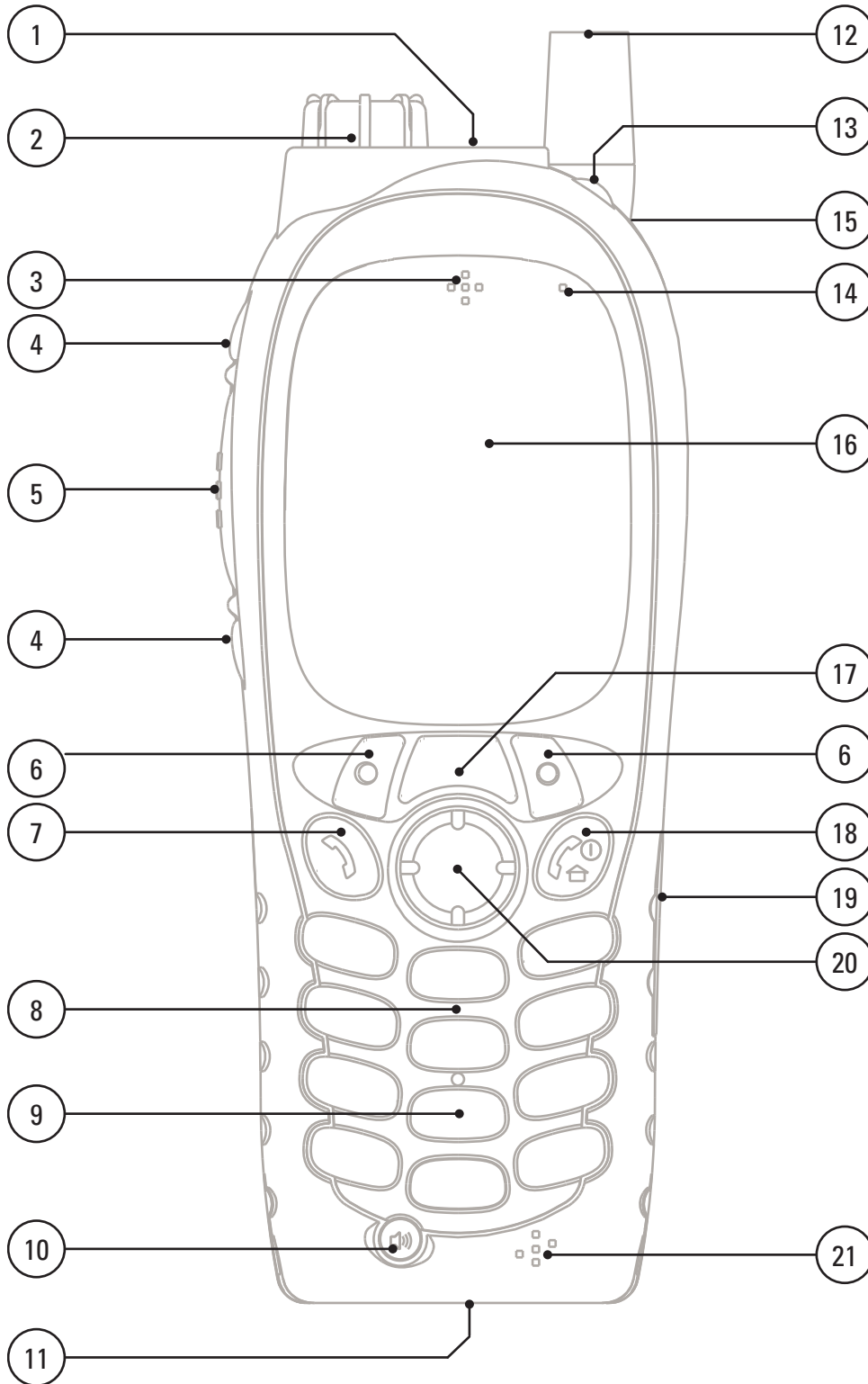

Table 16: Controls and Indicators







Annotation	Description
1	<p>EMERGENCY button</p> <p>Press and hold EMERGENCY button to enter Emergency operation. When your radio is off, press and hold to power on in Emergency Mode.</p>
2	<p>ROTARY KNOB</p> <ul style="list-style-type: none"> • Rotate to set the volume. • Press and rotate to select a different talkgroup. • Press and hold the ROTARY KNOB to lock/unlock it. Powering off also unlocks a locked ROTARY KNOB.
3	<p>EARPIECE</p>
4	<p>SIDE button</p> <p>The ROTARY KNOB and SIDE buttons programming are paired. When the ROTARY KNOB is set to Volume or Dual, the SIDE buttons support the One-Touch Button feature. By default, the upper SIDE button is set to Backlight feature and the lower SIDE button is set to Screen Saver feature.</p> <p> Note: The required time to press and hold SIDE button to activate an One-Touch Button feature is set as default to 0,1 second.</p>
5	<p>PTT (Push-To-Talk)</p> <ul style="list-style-type: none"> • Press and hold to talk in simplex calls or to initiate a group call, release it to listen. • Press to send status and text messages.
6	<p>SOFT key</p> <p>Press left or right SOFT key, to select the option that appears on the screen directly above the them.</p>
7	<p>SEND key</p> <p>Press to initiate or answer duplex calls, or send messages.</p>
8	<p>SPEAKER (under keypad)</p>
9	<p>KEYPAD</p> <p>Use the keypad to enter alphanumeric characters for dialing, contact entries, and text messages.</p> <p>Your radio supports the One-Touch Button feature that allows you to activate commonly used features by pressing and holding assigned key (0-9, * and #).</p> <p> Note: The required time to press and hold assigned key to activate an One-Touch Button feature is set as default to 1 second.</p>
10	<p>SPEAKER CONTROL key</p> <p>Press the SPEAKER CONTROL key to activate the earpiece Speaker LOW or speaker Speaker HIGH.</p> <p> Note: In an Emergency Group Call, the speaker is activated regardless of the speaker setting.</p>

Table continued...

Annotation	Description
11	<p>ACCESSORY CONNECTOR</p> <p>Provides connection for accessories and cable for data transfer.</p> <p> Note: It is recommended to turn off the radio before connecting accessories.</p>
12	ANTENNA
13	LED
14	<p>TOP MICROPHONE</p> <p>Activated during Simplex, high audio calls such as Group Calls.</p>
15	<p>EXTERNAL ANTENNA CONNECTOR</p> <p>Used with the digital car kit to connect the RF signal to the external antenna.</p>
16	<p>DISPLAY</p> <p>Provides alphanumeric text and images within 65,536 colors and 130 x 130 pixels with backlight, scalable fonts, and contrast.</p>
17	<p>MENU key</p> <ul style="list-style-type: none"> • From the home screen, press to enter the main menu. • Used to enter the context-sensitive menu.
18	<p>ON/OFF/END/HOME key</p> <ul style="list-style-type: none"> • Press and hold to turn on/off your radio. • Press to end calls. • Press to return to the home screen.
19	<p>AUDIO ACCESSORY CONNECTOR</p> <p>Provides connection for audio accessories.</p> <p> Note: It is recommended to turn off the radio before connecting accessories.</p>
20	<p>NAVIGATION key</p> <p>Press up, down, left or right NAVIGATION key for list scrolling, while moving around the menu hierarchy, or for alphanumeric text editing.</p> <p>From the home screen, press to activate one of the following:</p> <ul style="list-style-type: none"> • down NAVIGATION key — enters Recent Calls menu item. • up NAVIGATION key — changes My Groups talkgroup folder. • left and right NAVIGATION key — toggles through the talkgroups.
21	BOTTOM MICROPHONE
	<p>Note: A detailed list of compatible accessories is included in <i>Accessory Leaflet</i>, part number: 6802972C31. To obtain the document, contact your service provider.</p>

Keypad Lock

You can lock the keypad to prevent accidental pressing of keys. The keypad lock can be invoked using the menu or predefined menu shortcut (by default **Menu**, *).

By default, while the keypad is locked, all front and side keys (including PTT) are inoperative except for the ON-OFF and EMERGENCY buttons. The PTT button behavior can be set in the codeplug.

When an incoming emergency call is received, the PTT button automatically unlocks for the call duration.

When the keypad is locked one of the following is displayed:

- **Nothing** — no notification is displayed.
- **Notification Only** — **Keys Locked** is displayed.
- **Notification and Instruction** — **Press Menu and * to unlock** is displayed.

The displayed option can be set in the codeplug. By default it is set to **Notification and Instruction**.

Automatic Keypad Lock

The automatic keypad lock is a feature enabling the radio to lock its keypad automatically after a defined period. The radio allows activating or deactivating the feature using the MMI. If the feature is enabled, after a defined time of inactivity the keypad locks automatically. Any user activity restarts the **Automatic Keypad Lock** timer. When the keypad locks automatically, the following notification is displayed **Keypad auto locked**. You can change the time value required for the automatic lock through the MMI.

One-Touch Button Feature

The One-Touch Button feature allows for quick activation of functions by pressing and holding keys or buttons assigned to those functions.

Table 17: One-Touch Button Features

Feature	Description
Backlight Toggle	Toggles the backlight settings.
Change Audio Profile	Change to the specific audio profile.
Change Talkgroup	Changes the talkgroup to the programmed one by your service provider.
Covert Mode	Turns on/off the Covert Mode.
Display Time	Displays universal time on the home screen.
Double Push PTT	Sends the D- PTT tone to the currently used talkgroup.
Extra Zoom On/Off	Turns on/off Extra Zoom.
Flip Display	Rotates the display by 180 degrees.
GPS Report	Sends a message with the radio's GPS location to a dedicated address.
Hi/Low Audio	Toggles high/low audio.
Initiate Call-Out Fallback Alert	Sends Call-Out Fallback Alert.
PABX Call	Initiates a PABX call to a predefined entry in the contact list.
Phone Call	Initiates a phone call to a predefined entry in the contact list.

Table continued...

Feature	Description
Previous Talkgroup	Changes the selected talkgroup of the radio to the talkgroup (DMO or TMO) that was selected previously.
Private Call	Initiates a private call (simplex or duplex) to a predefined entry in the contact list or to the last group call originator.
Rotary Switches Lock/Unlock	Locks/unlocks the Rotary Switches.
RUA/RUI Log On/Off	Asks for the credential or logs off the radio.
Screen Saver Activation	Turns on/off the Screen Saver feature.
Scroll Audio Profiles	Scrolls through all available audio profiles.
Sending Predefined Message	Sends a predefined message to a dedicated address.
Sending Status	Sends a dedicated status message to a dedicated address.
Sending User Defined Message	Sends a user defined message to a dedicated address.
Speaker Enable/Disable Per Call	Enables the loudspeaker for a duration of the ongoing call..
Timed Talkgroup Change	Makes a predefined talkgroup the selected talk group for a specified amount of time. While using the predefined talkgroup, the second press of the One-Touch Button results in: returning to the previously selected talkgroup, restarting the predefined time, or no action (depending on configuration). After the timer expires, the radio returns to the previously selected talkgroup.
TMO / DMO Switch	Toggles between TMO and DMO modes.
TMO Talkgroup Scan	Turns on/off the Talkgroup Scan feature in TMO Mode.
Transmit Inhibit Mode (TXI)	Turns on/off the Transmit Inhibit Mode.
Volume Down	<ul style="list-style-type: none"> Press to decrease the volume by one level. Press and hold to continuously decrease the volume to its minimum level.
Volume Up	<ul style="list-style-type: none"> Press to increase the volume by one level. Press and hold to continuously increase the volume to its maximum level.

Your service provider can assign one-touch functions only to the side buttons and keypad keys.



Note:

If the One-Touch Button feature is enabled, the One-Touch Dial is disabled. If no feature is assigned to a button, your radio displays an **Unassigned Button** message.

Display

This section presents the radio's default home screen elements.

**Table 18: Display**

Annotation	Description
1	Status icon area
2	Text display area
3	SOFT key area
4	MENU/Context sensitive icon

The color of the SOFT key area changes according to the mode the radio is in.

Table 19: Colors of the SOFT Key Area

Color	Mode or State
Light blue	Normal TMO and DMO Modes
Light red	Emergency Mode or Disaster Alert Call
Olive	Local Site Trunking Mode
Yellow	Call Out — Standby
Red	Call Out — Alert
Green	Call Out — Accepted
Blue	Radio Messaging Service (RMS)

Status Icons

Status icons appear when your radio is engaged in certain activities or when you have activated certain features.

The icons can appear in normal or large size. To manually enable/disable large status icons, go to **Menu** → **Setup** → **Display** → **Extended Status Icons**.

Table 20: Status Icons















Icon	Description
Trunked Mode Operation	
	In Service
	No Service
	Signal Strength – The more bars, the stronger the signal.
	Migration — Displayed when your radio is registered to the foreign network.
	Broadcast Call — Displayed when the radio is in the Broadcast Call.
	Scan — Indicates talkgroup scanning is activated in the radio.
	Priority Scan — Indicates that priority scanning is activated in the radio.
	Data Connected — Displayed when the data connection is idle (standby).
	Data Transmit/Receive — Displayed when the data connection is active. Number 1, 2, 3, or 4 indicates how much bandwidth is used during transmission (25%, 50%, 75%, or 100%).
Direct Mode Operation	
	Direct Mode Call — Displayed when the radio is receiving a Direct Mode call. The more bars, the stronger the signal.
	Direct Mode — Displayed when the radio is in Direct Mode (radio-to-radio communication).
	DMO Gateway Communication Mode — Indicates that gateway is selected. The icon has the following states: <ul style="list-style-type: none"> • Solid — while the radio is synchronized with the gateway. • Blinking — while the radio is not synchronized or during attachment. • No icon — during a radio to radio and repeater call.
	DMO Repeater Communication Mode — Displayed when the Repeater or GW + Rep option in DMO Mode is selected. This icon has the following states: <ul style="list-style-type: none"> • Solid — while the radio has detected the repeater (for example when the radio receives a presence signal). • Blinking — while the radio has not detected the repeater or during attachment. • No icon — during a radio to radio and gateway call.
General Icons	
	All Tones Off and Duplex and Simplex Ring Muted — Indicates that all alert tones are off and both duplex and simplex ring volume is set to 0. <ul style="list-style-type: none"> • Volume is set to 0 (when Volume Adj. Mode is set to Common).

Table continued...



















Icon	Description
	<ul style="list-style-type: none"> Both simplex and duplex ring volume is set to 0 (when Volume Adj. Mode is set to Individual).
	Simplex Ring Muted — Indicates that simplex ring volume is set to 0 and duplex ring volume is set to more than 0.
	Duplex Ring Muted — Indicates that duplex ring volume is set to 0 and simplex ring volume is set to more than 0.
	Vibrate On — Indicates that the radio vibrates to alert you of an incoming call.
	Vibrate then Ring — Indicates that the radio vibrates and rings to alert you of an incoming call.
	Low Audio — Indicates that the audio mode is changed to low.
	High Audio — Indicates that the audio mode is changed to high.
	Audio Profile Selected — Indicates that an audio profile associated with a particular icon is active. The icons can be either solid or blinking. For details on audio profiles available on the radio, contact your service provider.
	Earpiece Connected — Indicates that the earpiece is connected.
	GPS Icon <ul style="list-style-type: none"> Solid - the radio has a location fix Blinking - the radio is acquiring a location fix. This is an optional setting and may not be enabled on your radio.
	RUI Logged on — Indicates that you are logged on into the radio.
	RUI Pseudo Log On — Indicates that you are in pseudo logged on state.
	RUI Packet Data — Indicates Pseudo Log On state when the Packet Data feature is activated and active data session is in progress.
	RUI Packet Data — Indicates Pseudo Log On state when the Packet Data feature is activated and the external device sets up data connection with the radio.
	Battery Strength — Shows the charge of your battery.
	Battery Charging — Indicates that the battery is charging.
	Emergency — Appears while the radio is in Emergency Operation.
	Disaster Alert Call — Appears while the radio is in the Disaster Alert Call.
	List Scrolling — Displayed to indicate that the ROTARY KNOB is in list scrolling mode.

Table continued...



















Icon	Description
	New Message Has Arrived — Indicates a new message just arrived.
	New Message(s) in Inbox — Indicates that you have unread messages in your Inbox .
	Unread (New) WAP Message — Indicates that new page was loaded to the browser.
	Call-Out — Indicates Call-Out alert.
	Call-Out Alert Arrived — Indicates a receipt of a new Call-Out message.
	Call-Out Alert Unread — Indicates unread alert in the CO Box .
	<p>End-to-End Encryption (E2EE) Solid, when the E2EE is enabled</p> <ul style="list-style-type: none"> • for the selected talkgroup, • for the highlighted private number, • for the manually entered private number, • when transmitting voice in Group Calls, • when transmitting voice in Simplex Private Calls. <p>Blinking, when the End-to-End Encryption is enabled</p> <ul style="list-style-type: none"> • when receiving voice in Group Calls, • when receiving voice in Simplex Private Calls, • during encrypted Duplex Private Calls.
	<p>SDS End-to-End Encryption Solid, when the E2E status of an SDS message, or the E2E status of a message recipient address. In High Security mode, when your radio processes only the encrypted information, this icon is always visible in when you are in the messages menu (for example, Inbox).</p>
	Unread (New) WAP Message — Indicates that you have not entered WAP Box since last WAP message was received (Blinks when the priority is high).
	WAP Message Icon — Displayed next to the priority in the message list view.
	WAP Message Time — Displayed next to the create date in the message list view.
	WAP Message Expiration — Displayed next to the expiry date in the message list view.
	WAP Message Title Icon — Displayed next to the title along with the text in the message list view.
	Keys Locked — Indicates that keys are locked.
	<p>Non Secured Call — Air Encryption Unavailable Blinking, indicates that Air Encryption is not available when the radio:</p>

Table continued...

Icon	Description
	<ul style="list-style-type: none"> • Is in the Local Site Trunking Mode. • Attempts to connect to a gateway.
	<p>Not Secured Call — Air Encryption Unavailable Alternately blinking, indicates that Air Encryption is not available when the radio:</p> <ul style="list-style-type: none"> • Is in TMO Mode. • Communicates through a gateway.
	<p>Not Secured Call — Air Encryption Unavailable Blinking, indicates that Air Encryption is not available in DMO Mode. The icon appears after the PTT button is pressed.</p>
	<p>Remote Control Indicates that the radio is being remotely controlled and some commands are being executed in the background. For example, when the radio is controlled via special SDS messages or triggered to send a GPS location report. The icon is not visible in the Extra Zoom Mode.</p>

Idle Display

The terminals provide access to all services from the main idle display.

The idle display shows the following content.

- Icons on the status area (top line):

- Status icons.
- Battery level displayed at all times



Note: The terminal periodically repeats the audible and visible indication of low battery.

- Signal level icon.
 - Displayed in TMO at all times.
 - Displayed in DMO only when receiving a voice in a group call.
- Up to five lines of text.
 - Line 1: Network status or network identification (**No Service** or MCC/MNC or MCC/ MNC alias).
 - Line 2: Selected Group Folder.
 - Line 3: Selected Group.
 - Lines 4, 5: Home Mode Display (if available).
 - Line 5: Time and Date (if available).



Note: In case the time and date information for a specific language cannot be displayed in one line in the zoom or standard mode, the information is displayed in two lines. The time and date overwrite the second line of Home Mode Display if any.

- Softkey labels and optional menu icon.
- An optional wallpaper background.

From the idle display, you have an easy access to stored target lists.

- Pressing the UP key accesses the favorite talkgroups list.
- Pressing the DOWN key accesses the recent calls lists.
- Pressing the SEND key accesses the last dialed numbers list.

- Pressing the **Contcs** softkey accesses the address book.

Configurable Idle Screen

Your service provider can configure the information that is displayed on the home screen below the status icon area. Depending on the radio configuration and services supported, the following information can be displayed:

- Network alias
- Range alias
- Talkgroup alias
- Time and date
- Home mode display
- RMS/FMS
- ISSI
- Radio status
- Audio profile name

Display Features

The radio utilizes colors to highlight certain special situations:

- When the radio is in an emergency mode/call.
- When in the call-out mode (alert received state, standby state, accept the state).
- In the RUA/RUI, when you are logged on or pseudo logged on.

If the display flip is provisioned, the radio provides the ability to reverse the direction of the display. Hence, the display can be read when holding the radio upside down.

The radio has four font size levels that you can choose using the menu.

The backlight can be provisioned to operate in one of the following modes:

- Disabled — The backlight does not operate at all.
- Semi-Auto — Pressing a provisioned one-touch button toggles the on/off state of the backlight. The backlight is also turned off automatically when the backlight timer runs out.
- Auto — Pressing any key automatically turns on the backlight.

The backlight remains on until the backlight timer runs out, or if a provisioned one-touch button is pressed to turn it off. You can also toggle between the modes using the menu.

The radio supports an option to display a screen saver when the radio has been idle for a set time, or when you explicitly activate it. The screen saver consists of an image, which can be provisioned from any GIF image, and a text string which can also be provisioned. When the screen saver is being displayed, any key input or incoming service causes the screen saver to deactivate.

Languages Supported

Table 21: Languages Supported

Language	MTH800
English	Yes
Arabic	Yes
Chinese (simplified)	Yes
Chinese (traditional)	Yes

Table continued...

Language	MTH800
Croatian	Yes
Danish	Yes
Dutch	Yes
French	Yes
German	Yes
Greek	Yes
Hungarian	Yes
Italian	Yes
Korean	Yes
Lithuanian	Yes
Macedonian	Yes
Mongolian	Yes
Norwegian	Yes
Portuguese	Yes
Russian	Yes
Spanish	Yes
Swedish	Yes
User defined	Yes

Audio

Tones

Table 22: Radio Tones

Tone Name	Default Tone Diagram
Back to Coverage Back to Full Service	
Clear-to-send	
Bad Key Pressed	

Table continued...

Tone Name	Default Tone Diagram
From Out-of-Service to In Service	
In Emergency	
Talk Permit	
<ul style="list-style-type: none"> • Talk prohibit • System busy • Time-out timer expire • Called radio not available or busy 	
Call Disconnected or Failed Due to Network	
Toggling Between DMO and TMO	
Entering/Exiting Local Site Trunking	
Receiving/Sending Emergency Alarm	
Emergency Alarm Failed	
Entering Emergency	
Exiting Emergency	

Table continued...

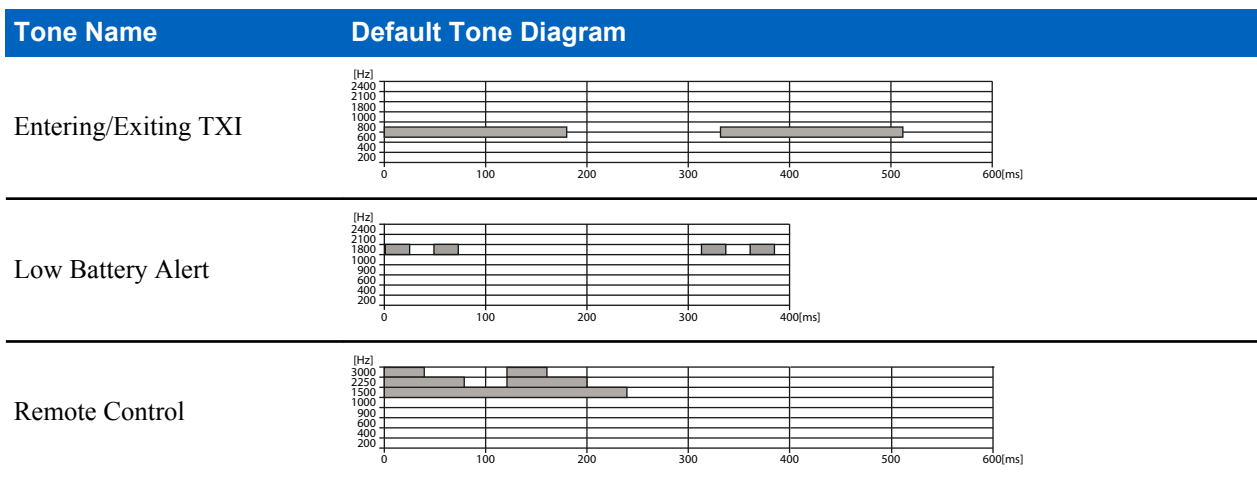

Note: All the audible indications can be disabled by your service provider.

Dual Microphones

Each radio has two microphones. One located at the top of the unit for dispatch (simplex) operation, and the second located on the bottom of the unit for duplex calls.

Table 23: Speaker Control Key Behavior

Call Type	Menu Setting	Key Use
Simplex call (Group/ Private)	Menu Setup → Audio → Audio Toggle → Spkr Cntrl	Speaker on/off for group and private calls
	Menu Setup → Audio → Audio Toggle → Always Loud	Speaker on/off for private calls
Duplex call (Private/Phone/ PABX)	—	Controls speaker/earpiece of an ongoing call



Note: In an emergency group call, the voice sounds from the speaker regardless of the speaker setting.

While the ambience listening is active or while being in the covert mode users cannot switch to the high audio mode by pressing the speaker control key.

Speaker/Earpiece

Each radio has an internal speaker for high audio (located at the middle of the unit) and an internal earpiece for low audio (located at the top of the unit). The audio can be routed either to the speaker or the earpiece using the Audio Toggle menu and the assigned One-Touch Button.

Volume Control

If the volume control mode is set to **Individually Controlled**, you can adjust the following volumes individually.

- Duplex (alerting volume at incoming phone/PABX or duplex private call).
- Simplex (alerting volume at incoming simplex private call).
- Earpiece (voice audio volume in the internal or external earpiece).
- Speaker (voice audio volume in the speaker).
- Keypad (keypad tones volume).

The adjustments are made for the volumes within the ranges defined in the audio mode. Simplex and duplex calls use the same range. All other volumes are fixed for each audio mode.

If the volume control mode is set to **Commonly Controlled**, you can adjust only all volumes at the same time.

When the rotary knob is in the volume mode the radio adjusts the value of the commonly controlled volume along with the audio volume.

Volume Adjustment Mode

You can set the volume to **Individual** or **Common**. When it is set to **Individual**, the volume level for **Voice**, **Duplex**, **Simplex**, **Earpiece**, **Speaker** and **Keypad** can be set per user preferences. When set to **Common**, the audio has one setting for all items.

Accessory Setup

When connecting an accessory to the radio's side connector, if it is an IMPRES accessory, the radio detects and recognizes the accessory automatically. Else, if the accessory is CORE, Other (i.e. 3rd party accessory, detected by specific resistance values), or Secondary Accessory (i.e. an earpiece connected to RSM), the radio may detect the connection, however, the accessory has to be set manually via the Accry Setup menu (or CPS: Audio Settings). This menu contains the supported accessories, represented by their Model Number as defined by the related ADD.

Audio Device Descriptor (ADD) is a set of parameters in the radio, which defines the audio setting (e.g. gains and filters settings) for each accessory. For Motorola accessories, the ADDs are predefined and cannot be changed by the user. For 3rd party accessories, the ADD parameters are configurable via CPS (Audio Settings -> 3rd Party Accessory Device Parameter) – please refer to the licensable “Motorola 3rd Audio Device Descriptor (ADD) parameter creation for 3rd party audio accessories” document. Motorola ADDs can be imported and removed via CPS (Buttons, Keys and Accessories -> ADD Import / Remove).

Man-Machine Interface Testing

Test Page



Note: The Test Page option must be enabled in the codeplug. The test page is only for use by authorized persons. When using KVL 3000 (a portable device used to load encryption keys to a secure entity), set the baud rate on it to 19200 bits/second.

Use the following key sequence to access the test page: *, #, MENU, RIGHT.



Note: If the test page option is not enabled in the codeplug, you have only access to the KVL mode options **KVL On** or **KVL Off**.

The following information is available in the test page.

- **Ver Info** – Version Information – displays software/hardware version information.
 - **Build Date** – software build (a compiled version of software)
 - **CP Ver** – CodePlug version
 - **DSP Ver** – Signalling Processor Software version
 - **Host Ver** – Application Software version
 - **HardwareID** – hardware identification number
 - **EquipID** – TEI (Tetra Equipment Identity)
 - **LLS version**– Local Language Package version
- **Addresses;**
 - **Home MNI** – country identification code, network code
 - **Group ID** – number of the currently selected talkgroup

- **Own ISSI** – Own Individual Short Subscriber Identity
- **ASSI** – Alias Short Subscriber Identity
- **Err Logs** – Error Logs – displays information about software errors.
- **Cells Info** – Cell Information – displays information about the foreground and background cells (BTS sites). This menu displays the RSSI levels of the cells.
- **Cell Lists** – Displays frequency lists.
 - Frequency **List1** (32 variable frequencies)
 - Frequency **List2** (32 fixed frequencies)
 - Frequency **List3** (comprehensive hunt)
 - Frequency **List4** (comprehensive hunt)
- **Data Svc** – Data Services – allows access to the air tracer enable, the conformance tests, and the KVL mode.
 - **Air Tracer**
 - **Conf Test** – Conform test
 - **KVL Mode**



Note: In the KVL mode, the display is immediately dark and empty. However, the green LED is on. During data exchange with the AIE KVL, the orange LED is on. On successful key exchange, the green LED is on again. In any error situation, the red LED is on. You can leave the KVL mode by pressing the power button.

- **E2E KVL Mode**
 - **MS Logging**
 - **CE Monitor** – Crypto Engine Monitor
 - **Key Info** – Key Information — allows displaying the security information for the following conditions:
 - For the serving cell:
 - **Curr Cell SC** – Security class of the serving cell, that is Security Class 1, Security Class 2, Security Class 3, Security Class 3 with GCK.
 - For the group OTAR:
 - **CMG GSSI** – Crypto Management Group (CMG) group of MSs with common key material
 - For SDMO and TM-SCK OTAR:
 - **SCK SubsGrType** – SDMO SCK Subset Grouping Type.
 - **Curr Subs Info** – current SDMO SCK Subset Number and SCK-VN.
 - **Fallback TMSCK** – current Fallback TMO SCK, that is SCKN and SCK-VN attributes.
 - **SCK List** – list all SCKs stored in the MS, that is SCKN and SCK-VN attributes (SCK version number).
- Note:** When checking that the SDMO key information in the radio, be advised that the SDMO KAG (SDMO Key Association Group) range in the AuC (Authentication Centre) is from 0 to 9 and the range in the radio is from 1 to 10.
- For the GCK (Group Cipher Key):
 - **Full GCK-VN** – current Full GCK-VN. (GCK version number).
 - **GCK List** – list all GCKs stored in the MS, that is GCKN and GCK-VN attributes.
 - **DMO info** – Direct Mode Operation information (RSSI and Frequency)

Radio Info

Depending on the codeplug configuration the manufacturer, type, and serial number information is available. The information is available through the service page accessible from the MMI.

The Radio Info provides the following data:

- Manufacturer
- Product Type



Note: The manufacturer and product type information is displayed only on radios distributed under Motorola trademark.

- ISSI — the ISSI which is currently in use. If a SIM Card is present the ISSI is read from the card, otherwise it is taken from the codeplug.
- TEI — the TEI is displayed as a hexadecimal number.
- Serial number — Motorola serial number is displayed only on radios distributed under Motorola trademark.
- OPTA — if the BSI SIM support is disabled no OPTA information is displayed.

Hardware Test

This mode allows performing basic hardware tests and share the results immediately on the display.



Note: The hardware test mode is only for use by authorized persons.

Use the following key combinations to access the hardware test: 1, 2, 3 (hold all simultaneously) and then press ON/OFF key.

Appendix

A

Glossary

ADD

Audio Device Descriptors

AIE

Air Interface Encryption

Air Interface Encryption (AIE)

Provides confidentiality on the radio link over the air.

See also:

[Encryption](#) on page 103

Announced Cell Reselection

Cell reselection where radio Mobile Link Entity (MLE) informs the Switching and Management Infrastructure (SwMI) both in the serving cell and in the new cell that cell change is performed.

APAC

Asia Pacific region

ASSI

Alias Short Subscriber Identity

See also:

[Short Subscriber Identity](#) on page 110

Audio Device Descriptors (ADD)

A structure which provides hardware information about a particular audio accessory (for both IMPRESS and core accessories). Files with ADD have an extension .add.

Base Station

Term used to identify the installation including the BTS, antenna and ancillary equipment.

BTS

Base Transceiver Station

Calibration values

A set of important and unique, factory-defined values (such as frequency tuning) assigned to radios. Also known as Sensitive data.

CCK

Common Cipher Key

Central Network Equipment

The equipment located at the Master Site or Mobile Switching Office.

Class 3

DCK encryption, ESI with CCK, authentication.

Clear

Not encrypted.

Common Cipher Key (CCK)

Used to encrypt group and broadcast addressed downlink signaling (from infrastructure to a radio). Also used to protect ISSI identities.

See also:

Encryption on page 103

Individual Short Subscriber Identity on page 105

Control Channel

The always active control channels transmit and receive the signaling to monitor and control the operation of radios.

CPS

Customer Programming Software

Customer Programming Software (CPS)

The software application used for programming radios.

DCK

Digital Car Kit

DCK

Derived Cipher Key

Derived Cipher Key (DCK)

Used to encrypt all uplink signaling (from radios to infrastructure) and individually addressed downlink signaling (from infrastructure to a radio).

See also:

Encryption on page 103

DGNA

Dynamic Group Number Assignment

Direct Mode Operation (DMO)

Direct communications between two or more radios without the use of any infrastructure.

DMO

Direct Mode Operation

DTE

Data Radio Equipment

DTMF

Dual Tone Multi-Frequency

Dual Tone Multi-Frequency (DTMF)

Tone-based signaling scheme which combines two of a set of standard frequencies. The result is a third or beat frequency (signal) which is the desired or usable signal. DTMF signaling is used as tone-dialing in the common telephone.

Dynamic Group Number Assignment (DGNA)

DGNA is a possibility to provision talkgroups into the radio over the Air Interface.

See also:

Talkgroup on page 110

Encryption

Secure communications systems are designed to provide coded (?encrypted?) signals between some or all links in the system. In order to do this, each device involved in secure communications is loaded with a multi-digit encryption variable (called a key). This key is used by an encryption algorithm built into the device to encrypt voice or data as needed. Only devices in the system with the same algorithm and encryption key can decode the encrypted signals.

Encryption

The manipulation of a packet's data in order to prevent anyone but the intended recipient from reading that data. There are many types of data encryption, and they are the basis of network security.

ESI

Encrypted Short Identity

ESSC

EMEA System Support Center

ETSI

European Telecommunications Standards Institute

European Telecommunications Standards Institute (ETSI)

The European standards organization responsible for the TETRA standard.

Firmware

Computer instructions that reside as read-only software on a radio's flash memory.

Fixed Network Equipment

Switching and Management Infrastructure

Flash

A storage chip integrated in to radio hardware, that can be erased and reprogrammed.

Flashing

Writing a software image file to a radio.

GCK

Group Cipher Key

GCK KAR

Group Cipher Key Key Association Range

GPIO

General Programmable Input Output

Group Call

An instant communication between users that belong to the same talkgroup.

See also:

Talkgroup on page 110

Group Cipher Key (GCK)

Predetermined cipher key used to provide confidentiality in Class 3 system with corresponding algorithm. Used to generate MGCK.

See also:

Modified Group Cipher Key on page 106

Class 3 on page 102

Group Short Subscriber Identity (GSSI)

TETRA term, in Dimetra called Group ID or Talkgroup ID.

See also:

Short Subscriber Identity on page 110

GSSI

Group Short Subscriber Identity

Home Location Address

Area within radio coverage of a base station or group of base stations within which a radio is allowed to operate.

See also:

Base Station on page 101

Individual Short Subscriber Identity (ISSI)

TETRA term for a unique, individual ID assigned for each radio.

See also:

[Short Subscriber Identity](#) on page 110

Individual TETRA Subscriber Identity (ITSI)

Consists of ISSI plus MCC and MNC codes.

See also:

[Individual Short Subscriber Identity](#) on page 105

[Mobile Country Code](#) on page 106

[Mobile Network Code](#) on page 106

ISSI

[Individual Short Subscriber Identity](#)

ITSI

[Individual TETRA Subscriber Identity](#)

Key

Each device involved in secure communications is loaded with a multi-digit encryption variable ? an encryption key. An encryption algorithm built into the device uses this key to encrypt voice or data as needed. Only devices in the system with the same algorithm and encryption key can decode the encrypted signals.

See also:

[Encryption](#) on page 103

LIP

Location Information Protocol

Local Site Trunking (LST)

Allows radio subscribers of the same cell site to communicate when the link between the site and network central controller fails. Entering and exiting Local Site Trunking (that is, returning to Site Wide Trunking) is done automatically ? the display shows the ?Local Area Service? message Any call in progress is dropped upon entering Local Site Trunking mode. Registration, Group Call, and Emergency Call are available in Local Site Trunking.

See also:

[Central Network Equipment](#) on page 102

Location Request/Response Protocol (LRPP)

This protocol allows for a single and efficient format of passing location information (requests and responses).

LRPP

[Location Request/Response Protocol](#)

LST

[Local Site Trunking](#)

MACE

Motorola Advanced Crypto Engine

Main Control Channel (MCCH)

The main control channel at a site. The channel is used by radios to register on the system and to request and setup speech calls with other radios.

See also:

[Control Channel](#) on page 102

Man Machine Interface (MMI)

Relates to the CPS Plus and radios user interface.

MCCH

[Main Control Channel](#)

MLE

Mobile Link Entity

See also:

[Announced Cell Reselection](#) on page 101

MMI

[Man Machine Interface](#)

Mobile Country Code

The MCC and MNC together form a unique TETRA system identifier that is broadcast by a Dimetra system over the air interface.

Mobile Network Code

The Mobile Network Code should be allocated by the national authority that allocates frequency assignments in a country and should be requested from that authority at the same time as frequency allocations are requested. The MCC and MNC together form a unique TETRA system identifier that is broadcast by a Dimetra system over the air interface.

Modified Group Cipher Key

Used to encrypt group addressed downlink signaling.

NGCH

Next Generation Control Head

OTAR

[Over-The-Air-Rekeying protocol](#)

Over-The-Air-Rekeying protocol (OTAR)

Used in connection with Air Interface Encryption.

See also:

Air Interface Encryption on page 101

PABX

Private Automatic Branch Exchange

PABX Gateway

A device that provides connectivity from a TETRA user to a PABX subscriber and the other way around.

See also:

Private Automatic Branch Exchange on page 107

PDV2

Permanent Disable Version 2

PEI

Peripheral Equipment Interface

Permanent Disable Version 2 (PDV2)

You can restore a disabled radio using CPS Plus.

Personal Hands-Free kit (PHF)

In other words an earpiece or a handset.

PHF

Personal Hands-Free kit

Private Automatic Branch Exchange (PABX)

Allows to call local (office) extension numbers.

Private Call

An individual call between two radios or between a radio and a console operator. Apart from the two interlocutors, no one else can participate or listen to the call.

Private Duplex Call

A private call between two radios that resembles a telephone conversation. The two individuals can talk and listen at the same time without pressing PTT.

See also:

Private Call on page 107

Push-to-Talk on page 108

Private Number

Also called Private ID.

PSTN

Public Switched Telephone Network

PSTN Gateway

A device that provides connectivity from a TETRA user to a PSTN subscriber and the other way around. Additionally, for the duration of the call, the PSTN gateway allows TETRA signaling information to be passed from TETRA Switching and Management Infrastructure to the external network user and from the external network user to the TETRA SwMI in accordance with the TETRA Call Control (CC) procedures.

See also:

[Public Switched Telephone Network](#) on page 108

[Switching and Management Infrastructure](#) on page 110

PTPC

Point-to-Point Call

See also:

[Private Call](#) on page 107

PTT Button

Push-to-Talk button

Public Switched Telephone Network (PSTN)

Traditional telephone network.

Push-to-Talk

Pressing this button on a radio allows the subscriber to transmit.

Radio

A two-way communication device used for voice and data.

Radio User Assignment/Radio User Identity (RUA/RUI)

This feature allows to assign alphanumeric user names to radio users, and to authenticate the radio users in a logon process.

Radio User Assignment (RUA)

Part of RUA/RUI feature.

See also:

[Radio User Assignment/Radio User Identity](#) on page 108

Radio User Identity (RUI)

Part of RUA/RUI feature

See also:

[Radio User Assignment/Radio User Identity](#) on page 108

RCU

[Remote Control Unit](#)

Remote Control Unit (RCU)

A small device attached to a covert radio over a thin wire, used for operating the radio.

Remote flashing

Programming the transceiver via the control head.

RSM

Remote Speaker Microphone

RSSI

Radio Signal Strength Indicator

RUA

Radio User Assignment

RUA/RUI

Radio User Assignment/Radio User Identity

RUI

Radio User Identity

SCK

Static Cipher Key

SDMO KAG

Secure Direct Mode Operation Key Association Group

SDS

Short Data Service

Selling Feature

Requires a USB dongle with purchased licenses.

Semi-Duplex Private Call

Also called Private Call or Express Connect Call. In this type of one-way call, the user presses and holds the PTT while talking, and releases the PTT while listening.

See also:

Private Call on page 107

Push-to-Talk on page 108

Sensitive Data

A set of important and unique, factory-defined values (such as frequency tuning) assigned to radios.

Short Data Service (SDS)

A flexible bearer service that transfers information from one interface to another.

Short Subscriber Identity (SSI)

The network specific portion of a TETRA Subscriber Identity. An SSI is only unique within one TETRA subdomain (one TETRA network).

SIM

Subscriber Identity Module

Software Image

A collection of files distinguished by individual releases. It contains firmware, codeplug, and audio template files dedicated to specific radio models.

SSI

Short Subscriber Identity

Static Cipher Key (SCK)

Key used for encryption between radios and BTS in Class 2 systems with corresponding algorithm.

See also:

Encryption on page 103

Status ID

A feature that makes it possible for a subscriber to send status messages to other subscribers. The user can enter a status message for each ID in a Status ID list. When a subscriber sends a status message, the ID of the subscriber's unit is sent along with the status message.

Subscriber Identity Module (SIM)

A smart card that holds subscriber information (including the authentication key) and is inserted into the radio to grant its personality.

Switching and Management Infrastructure (SwMI)

All the system components excluding the mobile equipment that is the CNE and all the remote site equipment.

See also:

Central Network Equipment on page 102

SwMI

Switching and Management Infrastructure

Talkgroup

A group of radio users that can share calls and messages as a group. Normally a talkgroup is comprised of users who have a need to communicate with each other on a day-to-day basis.

TEI

TETRA Equipment Identity

Telephone Interconnect (TI)

A call feature that provides subscriber access to the Public Switched Telephone Network (PSTN). Telephone interconnect can be used for both land-to-mobile calls and mobile-to-land calls.

See also:

[Public Switched Telephone Network](#) on page 108

TETRA

Acronym for TERrestrial Trunked RAdio. The digital trunked radio standard produced by ETSI providing detailed telecommunications specifications to which Base Stations and radios should adhere.

See also:

[Base Station](#) on page 101

[European Telecommunications Standards Institute](#) on page 103

[Radio](#) on page 108

TETRA Equipment Identity (TEI)

An electronic serial number that is permanently embedded in the TETRA equipment, like radios.

TI

[Telephone Interconnect](#)

TMO

Trunked Mode Operation

Trunked

[Trunked Radio Communications](#)

Trunked Radio Communications (Trunked)

A computer controlled communications system that allocates speech channels on demand selecting on a random basis from the group of channels available.

Upgrade

To replace radio firmware with a newer version and preserve User and Sensitive Data.

User Data

A set of codeplug nodes and values, that can be edited and replicated to other codeplugs or radios.

VASSI

Visitor Alias Short Subscriber Identity

