

CLP Series Two-Way Radio User Guide



DECEMBER 2023

© 2023 Motorola Solutions, Inc. All Rights Reserved.



6801200044-EE

Contents

Intellectual Property and Regulatory Notices.....	5
Batteries, Chargers, and Audio Accessories Safety Information.....	6
Operational Safety Guidelines.....	6
FCC Licensing Information.....	7
Radio Frequency Exposure Safety Standards.....	8
Introduction.....	9
Package Content.....	9
Chapter 1: Radio Overview.....	10
Chapter 2: Getting Started.....	11
2.1 Installing the Battery.....	11
2.2 Connecting Wired Audio Accessory.....	11
2.3 Bluetooth Wireless Accessory.....	13
2.3.1 Adding Bluetooth Headset.....	13
2.3.2 Reconnecting to the Last Connected Bluetooth Headset.....	13
2.3.3 Erasing Bluetooth Headset History and Adding Bluetooth Headset.....	14
2.4 Turning the Radio On or Off.....	14
2.5 Adjusting the Volume.....	14
2.6 Inserting and Removing the Swivel Belt Clip Holster.....	14
2.7 Transmitting and Receiving.....	16
2.7.1 Talk Range.....	16
2.8 Menu Setting.....	16
2.8.1 Operations Using Menu Settings.....	17
2.9 Selecting Channels.....	17
2.9.1 Default Channel Settings for CPS.....	17
2.10 Monitoring Channels.....	18
2.11 Scan.....	18
2.11.1 Scanning Radio Channels.....	19
2.12 Dynamic Talkaround Scan.....	19
2.13 Sending Call Tones.....	19
2.14 Muting the Radio.....	19
2.15 Talk Permit Tone.....	20
Chapter 3: Battery and Charger.....	21
3.1 Battery Specifications.....	21
3.2 Battery Life.....	21
3.3 Battery Recycling and Disposal.....	21

3.4 Removing the Lithium-Ion Battery.....	22
3.5 Power Supply, Adapter, and Drop-in Tray Charger.....	22
3.6 Stand-Alone Battery.....	23
3.6.1 Charging a Stand-Alone Battery with the Drop-in Tray Charger.....	24
3.6.2 Estimated Charging Time.....	24
3.7 Charging Radio with the Drop-in Tray SUC.....	24
3.8 Charging with the Drop-In Tray MUC-Optional Accessory.....	25
3.9 Charger LED Indications.....	26
3.10 Charging the Bluetooth Headset.....	26
3.11 Checking Battery Status.....	27
Chapter 4: Radio Programming through CPS.....	29
4.1 Programming the Radio.....	29
4.2 Factory Default Settings.....	30
Chapter 5: Radio Cloning.....	32
5.1 Cloning Radio Settings.....	32
5.2 Cloning Radios using the Cloning Cable.....	32
5.3 Cloning Radios using the Multi-Unit Charger.....	33
5.4 Troubleshooting Cloning Mode.....	34
Chapter 6: Advanced Radio Configuration.....	35
6.1 Entering Advanced Radio Configuration Mode.....	35
Chapter 7: Troubleshooting.....	36
7.1 Symptom and Solutions.....	36
Chapter 8: Use and Care.....	39
Chapter 9: Radio Frequency and Code Chart.....	40
9.1 CLP Frequencies	40
9.2 CTCSS/DPL Interference Eliminator Codes.....	41
Chapter 10: Motorola Solutions Limited Warranty for the United States and Canada.....	44
10.1 Warranty.....	44
10.2 Products and Accessories.....	44
10.3 Exclusions.....	44
10.4 Software.....	45
10.5 Warranty Coverage.....	46
10.6 Warranty and Service Support.....	46
10.7 Retain Your Original Proof of Purchase.....	46
10.8 How to Obtain Warranty Service or Other Information.....	46
10.9 Software Copyrights Notice.....	46
10.10 Patent Notice.....	47

10.11 Export Law Assurances.....47

Chapter 11: Accessories.....48

Intellectual Property and Regulatory Notices

Copyrights

The Motorola Solutions products described in this document may include copyrighted Motorola Solutions computer programs. Laws in the United States and other countries preserve for Motorola Solutions certain exclusive rights for copyrighted computer programs. Accordingly, any copyrighted Motorola Solutions computer programs contained in the Motorola Solutions products described in this document may not be copied or reproduced in any manner without the express written permission of Motorola Solutions.

No part of this document may be reproduced, transmitted, stored in a retrieval system, or translated into any language or computer language, in any form or by any means, without the prior written permission of Motorola Solutions, Inc.

Trademarks

MOTOROLA, MOTO, MOTOROLA SOLUTIONS, and the Stylized M Logo are trademarks or registered trademarks of Motorola Trademark Holdings, LLC and are used under license. All other trademarks are the property of their respective owners.

License Rights

The purchase of Motorola Solutions products shall not be deemed to grant either directly or by implication, estoppel or otherwise, any license under the copyrights, patents or patent applications of Motorola Solutions, except for the normal nonexclusive, royalty-free license to use that arises by operation of law in the sale of a product.

Open Source Content

This product may contain Open Source software used under license. Refer to the product installation media for full Open Source Legal Notices and Attribution content.

European Union (EU) and United Kingdom (UK) Waste of Electrical and Electronic Equipment (WEEE) Directive



The European Union's WEEE directive and the UK's WEEE regulation require that products sold into EU countries and the UK must have the crossed-out wheellie bin label on the product (or the package in some cases). As defined by the WEEE directive, this crossed-out wheellie bin label means that customers and end users in EU and UK countries should not dispose of electronic and electrical equipment or accessories in household waste.

Customers or end users in EU and UK countries should contact their local equipment supplier representative or service center for information about the waste collection system in their country.

Disclaimer

Please note that certain features, facilities, and capabilities described in this document may not be applicable to or licensed for use on a specific system, or may be dependent upon the characteristics of a specific mobile subscriber unit or configuration of certain parameters. Please refer to your Motorola Solutions contact for further information.

© 2023 Motorola Solutions, Inc. All Rights Reserved

Batteries, Chargers, and Audio Accessories Safety Information

This document contains important safety and operating instructions. Read these instructions carefully and save them for future reference. Before using the battery charger, read all the instructions and cautionary markings on:

- the charger
 - the battery
 - the radio attached with battery
1. To reduce risk of injury, charge only the rechargeable Motorola Solutions-authorized batteries. Charging the other batteries may cause explosion, personal injury, and damage.
 2. Use of accessories not recommended by Motorola Solutions may result in fire, electric shock, or injury.
 3. To reduce damage to the electric plug and cord, pull by plug rather than the cord when disconnecting the charger.
 4. An extension cord should not be used unless necessary. Use of an improper extension cord may result in fire and electric shock. If an extension cord must be used, make sure that the cord size is 18 AWG for lengths up to 2.0 m (6.5 feet), and 16 AWG for lengths up to 3.0 m (9.8 feet).
 5. Do not operate the charger if it has been broken or damaged in any way. Take it to any qualified Motorola Solutions service representatives.
 6. Do not disassemble the charger; it is not repairable and replacement parts are not available. Disassembly of the charger may result in risk of electrical shock or fire.
 7. To reduce risk of electric shock, unplug the charger from the AC outlet before attempting any maintenance or cleaning.

Operational Safety Guidelines

- Turn off the radio while charging.
- The charger is not suitable for outdoor. Use only in dry locations or conditions.
- Disconnect charger from line voltage by removing main plug.
- Connect the equipment to an outlet which is easy to access and near.
- For equipment using fuses, replacements must comply with the type and rating specified in the equipment instructions.
- Maximum ambient temperature around the power supply equipment must not exceed 40 °C (104 °F).
- Make sure the cord is not stepped on, tripped over, subjected to water, damage, or stress.

FCC Licensing Information

This device complies with Parts 90 and 15 of the Federal Communications Commission (FCC) Rules.

Operation is subject to the condition that this device does not cause harmful interference. The radio operates on radio frequencies that are regulated by the Federal Communications Commission (FCC). To transmit on these frequencies, you are required to have a license issued by the FCC. Application is made available on FCC Form 601 and Schedules D, H, and Remittance Form 159.

To obtain these FCC forms, request document 000601 which includes all forms and instructions. If you wish to have the document faxed, mailed, or have questions, use the following contact information.

Fax

Contact the Fax-On-Demand system at 1-202-418-0177

Mail

Call the FCC forms hotline at 1-800-418-FORM or 1-800-418-3676

Contact

For questions regarding FCC license, contact 1-888-CALL-FCC, 1-888-225-5322, or <http://www.fcc.gov>.

Before filling out your application, you must decide which frequency you can operate on. For questions on determining the radio frequency, call Motorola Solutions Product Services at: 1-800-448- 6686. Changes or modifications not expressly approved by Motorola Solutions may void the user authority granted by the FCC to operate this radio and should not be made. To comply with FCC requirements, transmitter adjustments should be made only by or under the supervision of a person certified as technically qualified to perform transmitter maintenance and repairs in the private land mobile and fixed services as certified by an organization representative of the user of those services.

Replacement of any transmitter component such as crystal, semiconductor, and others not authorized by the FCC equipment authorization for this radio could violate FCC rules.



NOTE: Use of this radio outside the country where it was intended to be distributed is subject to government regulations and may be prohibited.

Radio Frequency Exposure Safety Standards

Product Safety and RF Exposure Compliance.



CAUTION:

Before using the radio, read the operating instructions for safe usage contained in the Product Safety and RF Exposure booklet contained with your radio.

ATTENTION!

This radio is restricted to Occupational use only to satisfy FCC RF energy exposure requirements.

Before using the radio, read the RF Energy Exposure and Product Safety Guide for Portable Two-Way Radios which contains important operating instructions for safe usage and RF energy awareness and control for Compliance with applicable standards and Regulations.

For a list of Motorola Solutions-approved antennas, batteries, and other accessories, visit the following website:

<http://www.motorolasolutions.com/CLP>

Introduction

This user guide covers the operation of your radios.

Your dealer or system administrator may have customized your radio for your specific needs. Check with your dealer or system administrator for more information.

You can consult your dealer or system administrator about the following:

- Is your radio programmed with any preset conventional channels?
- Which buttons have been programmed to access other features?
- What optional accessories may suit your needs?
- What are the best radio usage practices for effective communication?
- What maintenance procedures that helps promote longer radio life?

Package Content

This section provides information regarding package content for the radio.

Your product package contains the following products and manuals:

- CLP Series Two-way Radio
- Swivel Belt Clip Holster
- Lithium-Ion Battery and Battery Door
- Drop-In Tray Charger with Transformer
- Audio Accessory
- Quick Start Guide, Chargers Instructions Leaflet, RF Safety Booklet
- Warranty Card

For product information, refer to <https://learning.motorolasolutions.com>.

For product related questions, contact the followings:

- 1-800-448- 6686 in the USA
- 1-800-461-4575 in Canada
- 1-866-522-5210 on your TTY (Text Telephone)

This user guide covers the following models:



NOTE: Certain models may or may not be available at the time of purchase.

Model	Frequency Band	Transmit Power	No. of Channels	Bluetooth	Repeater Compatibility
CLP1010	UHF	1 W	1	No	Yes
CLP1040			4	No	Yes
CLP1060			6	Yes	Yes

Chapter 1

Radio Overview

This chapter explains the buttons and functions of the radio.

Figure 1: Radio Controls

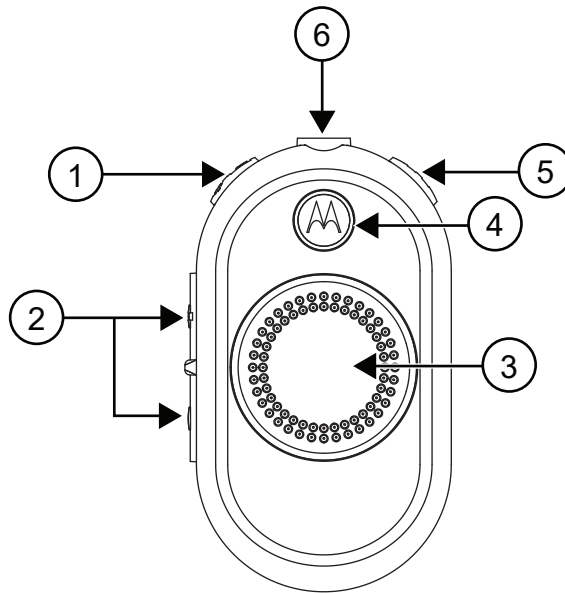

Item Number	Description
1	Power and Battery button
2	Volume Control (+/-) and Mute button
3	Push-to-Talk (PTT) button
4	Smart Status Glow Ring
5	Menu button
6	Accessory Connector

Chapter 2

Getting Started

This section helps you to get familiar with the basic operations of the radio.

2.1

Installing the Battery

Procedure:

1. At the bottom of the battery door, lift the latch up and remove the battery door of the radio.
2. Align the battery contacts to the tabs of the battery compartment.
3. Insert the end with the battery contacts before pressing the battery down to secure in place.
4. Place the battery door on the radio and push the latch down to lock the battery door.

Figure 2: Battery Installation

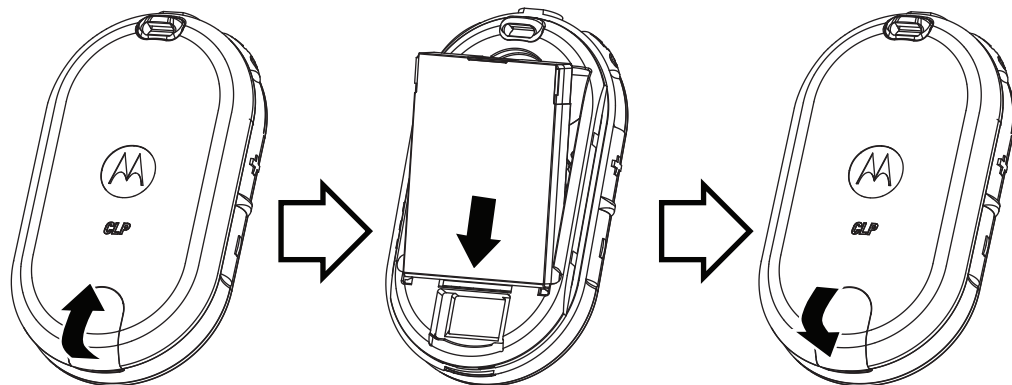

 **NOTE:** The standard package of a CLP Series radios comes with a standard Lithium-Ion battery and a battery door. For other options, customers can order Hi-capacity Lithium-Ion battery (P/N HKNN4013) and the Hi-capacity Lithium-Ion battery door (P/N HKLN4440).

2.2

Connecting Wired Audio Accessory

Prerequisites: Turn the radio off.

Procedure:

1. Remove the accessory connector cover.



NOTE: Applicable on Bluetooth wireless technology enabled models only.

2. Plug the audio accessory straight into the accessory connector on the radio.
3. Screw the audio accessory plug into the connector until it is tight and fully engaged with the connector.

Figure 3: Connecting Wired Audio Accessory

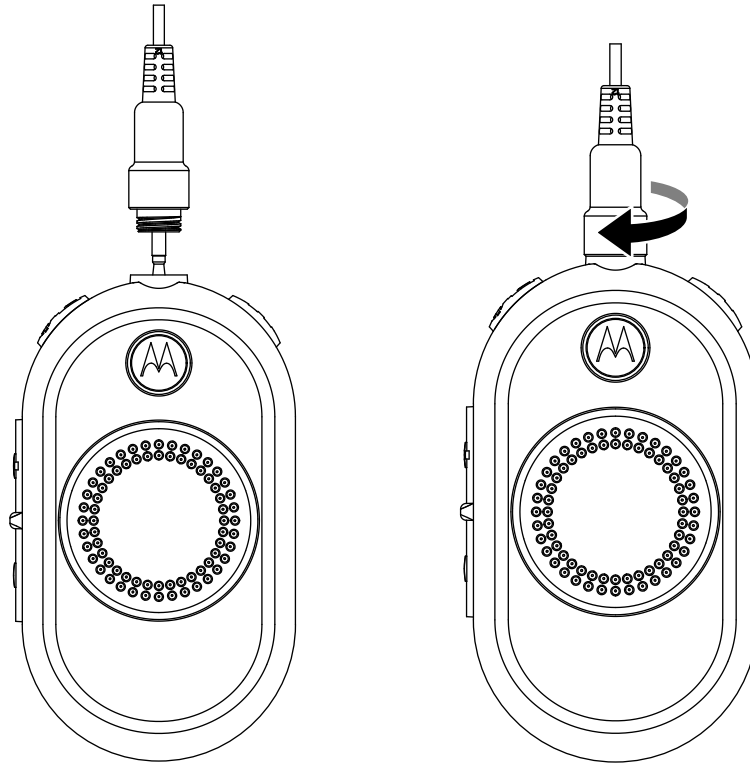

4. Turn the radio on.
5. To check for audio through the audio accessory, press either the **Battery Status, Menu, or Volume Control** button.



NOTE: Lower the radio volume before placing the audio accessory in or near your ear.

The CLP Series radios offer various audio accessories. For detailed audio accessories list, refer to <http://www.motorolasolutions.com/CLP> for information on approved accessories.

2.3

Bluetooth Wireless Accessory

This section provides information regarding bluetooth wireless accessory.

2.3.1

Adding Bluetooth Headset





The following are the steps for initial pairing

Prerequisites: Turn the radio off.

Procedure:

1. Put the bluetooth headset in pairing mode. Refer to your Bluetooth headset instructions leaflet.
2. Press and hold the **PTT** button and **Power** button simultaneously until your radio shows the blue LED.

Table 1: LED Configuration

User Mode	LED Status	Color
Bluetooth Pairing Mode	Last connection-fast blinking blue Add or erase - solid blue	
Pairing Successfully	Blue/purple blinks for 5 seconds	
Bluetooth Disconnected	Red/purple blinks until the radio reconnects	
Pairing Fail or Timeout	Red/purple blinks until the radio reconnects	



NOTE: The Bluetooth feature is disabled when the wired audio accessory is plugged into the accessory connector on the CLP radio.

2.3.2

Reconnecting to the Last Connected Bluetooth Headset

Prerequisites: Ensure the Bluetooth headset is turned on.

Procedure:

1. Turn the radio off.

2. To turn on the radio, press the **Power** button.

2.3.3

Erasing Bluetooth Headset History and Adding Bluetooth Headset

Prerequisites: Turn the radio off.

Procedure:

1. Put the Bluetooth headset in pairing mode. Refer to your Bluetooth headset instructions leaflet.
2. Press and hold the **Menu** and **Power** buttons simultaneously until your radio shows the blue LED.

 **NOTE:** The CLP radio uses proximity pairing. Ensure the headset is close enough to the CLP radio. Pairing process takes about 14 seconds.

2.4

Turning the Radio On or Off

Procedure:

1. To turn on the radio, press and hold the **Power** and **Battery** button until you hear a short tone and the Smart Status Glow Ring illuminates.
2. To turn off the radio, press and hold the **Power** and **Battery** button until you hear a short tone and the Smart Status Glow Ring indicator blinks once.

2.5

Adjusting the Volume

Procedure:

1. To increase the volume, press the **+** button.

 **NOTE:** Radio has 16 increments of volume.

2. To decrease the volume, press the **-** button.

2.6

Inserting and Removing the Swivel Belt Clip Holster

The radios offer various flexible carrying accessories. For Motorola Solutions approved accessories list, refer to <http://www.motorolasolutions.com/CLP>.

Procedure:

1. To insert the radio into the holster, perform the following steps:
 - a. Slide the bottom of the radio into the holster.

- b. Snap the top of the holster into the radio around the accessory connector.
- 2. To remove radio from the holster, pull either the top or bottom tab and pull the radio from the holster.

 **NOTE:** For optimal plug retention, loop the cord into the recess in the rear of the holster when using a corded audio accessory.

- 3. Make a small loop in the cord and pass the cord through the cord guide. Nest the cord in the U-shaped groove and pull tight to lock the cord in place.

Figure 4: Swivel Belt Clip Holster

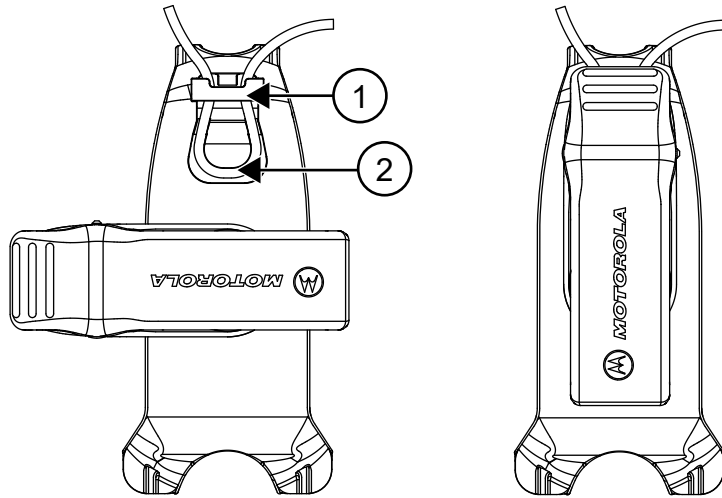

Item Number	Description
1	Cord Guide
2	U-Shaped Groove

- 4. Turn the belt clip to the position as needed.

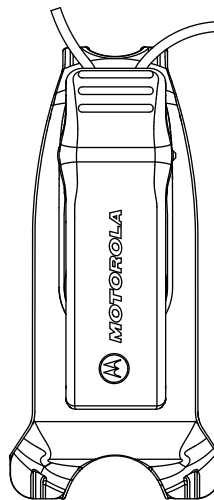

2.7

Transmitting and Receiving

Procedure:

1. To transmit calls, perform one of the following actions:
 - Press and hold the **PTT** button on the front of the radio.
 - Press and hold the **PTT** button on the wired audio accessory with the inline **PTT** button.
2. Speak clearly into the microphone on the audio accessory.
3. Release the **PTT** button to listen.
4. To receive calls, listen through the earpiece and press the **PTT** button to respond.



NOTE: The CLP Series radios always require the use of an audio accessory with microphone and speaker.

2.7.1

Talk Range

Table 2: Talk Range

Application	Industrial (Inside steel/concrete industrial buildings)	Multi-Level (Inside multi-level buildings)
Unit to Unit	Up to 100,000 ft ² (9,200 m ²)	Up to 10 floors
With Repeater	Up to 250,000 ft ² (23,200 m ²)	Up to 20 floors

2.8

Menu Setting

Procedure:

1. To navigate through the menu settings, press the **Menu** button.
2. To exit the menu, short press the **PTT** button or wait for three seconds.



NOTE: Voice Assisted Operation feature may not be available on certain previous shipping radios.

2.8.1

Operations Using Menu Settings

This section explains operations using the menu settings.



NOTE:

It is not necessary to wait for the voice prompt to be completed before continuing with pressing the next button.

If you are in the menu mode, short press **PTT** or wait 3 seconds to exit the menu.

The Voice Assisted Operation feature may not be available on certain previous shipping radios.

For single channel models, monitor, scan mode, and call tone are supported. Single channel models support scan mode when you enable **Dynamic Talkaround Scan** on a repeater channel through the Customer Programming Software (CPS).

Procedure:

1. Changing channel:
 - a. Press **Menu** button to navigate to **Channel**.
 - b. Press the **+** or the **-** button to change channel.
2. Entering Monitor Mode:
 - a. Press **Menu** button to navigate to **Monitor**.
 - b. Press the **+** to activate or the **-** button to deactivate monitor.
3. Entering Scan Mode:
 - a. Press **Menu** button to navigate to **Scan**.
 - b. Press the **+** to activate or the **-** button to deactivate scan.
4. Sending Call Tone:

Enabled through Customer Programming Software (CPS).

 - a. Press **Menu** button to navigate to **Call Tone**.
 - b. Press the **+** or the **-** button to send call tone.

2.9

Selecting Channels

The following procedures are for multi-channel models only.

Procedure:

1. Press the **Menu** button.

You hear a voice prompt to change channel by pressing the **+** or **-** button.
2. Select the required channel.











The LED indicates the color of the new channel.
3. Press the **PTT** button to confirm or the channel is activated after three seconds hang time.

2.9.1

Default Channel Settings for CPS

The table describes the default channel settings for Customer Programming Software (CPS).

Table 3: Channel Settings for CPS

CLP1010 Single-Channel Models			CLP1040 Multi-Channel Models			CLP1060 Multi-Channel Models		
Channel	LED Status	Color	Channel	LED Status	Color	Channel	LED Status	Color
1		Red	1		Red	1		Red
			2		Green	2		Green
			3		Yellow	3		Yellow
			4		Blue	4		Blue
						5		Purple
						6		White

2.10

Monitoring Channels

Procedure:

1. To activate the monitor selection mode, press the **Menu** button and navigate to **Monitor Selection**.
 If the monitor is off, you hear a voice prompt to activate the monitor mode by pressing either **+** or **-** button.
2. Press either **+** or **-** button to activate or deactivate the monitor mode.
 When the monitor mode is on, you hear static if no activity is present or audio if channel activity is present.
3. To engage the monitor mode, enable monitor through the menu and let the menu time out.
4. To exit the **Monitor** mode, press the **PTT** button.

2.11

Scan

You can scan up to four channels on CLP1040 models and six channels on CLP1060 models.

When the radio detects activity, it stops scanning and locks in on the active channel. This allows you to listen and talk to the person transmitting without changing channels.

2.11.1

Scanning Radio Channels

Procedure:

1. To navigate to Scan mode, press the **Menu** button.
If the scan is off, you hear a voice prompt to activate Scan by pressing either **+** or **-** button.
2. To activate scan, press either **+** or **-** button.
When scan is on, you hear a voice prompt to deactivate Scan by pressing the **+** or **-** button.
3. To deactivate scan, press either **+** or **-** button.

2.12

Dynamic Talkaround Scan

This feature maximizes communication coverage for an on-site repeater enabled on two way radio systems.

Dynamic talkaround scan is enabled on a repeater channel through the Customer Programming Software (CPS). The feature gives the radio the ability to scan the transmit and receive frequencies of a repeater channel.



NOTE: This is an enhancement feature on CLP radios and may not be available on previous shipping radios. The feature is given higher priority than the scan mode. If the dynamic talkaround scan and scan are enabled on the home channel, then the radio can only support the dynamic talkaround scan.

2.13

Sending Call Tones

Procedure:

1. To navigate to **Call Tone**, press the **Menu** button.
2. To transmit a selected call tone, press either **+** or **-**.



NOTE: Four call tones are available.

This feature is enabled through Customer Programming Software (CPS).

2.14

Muting the Radio

The mute function allows you to lower the headset volume,

Procedure:

1. To lower or mute the volume, press and hold either **+** or **-** button.
You hear a "Mute" voice prompt from the radio.
2. To unmute the volume, press any button.



NOTE: This is an enhancement feature on CLP radios and may not be available on previous shipping radios. The enhanced CLP radios does not support the volume scroll.

You hear an "Unmute" voice prompt from the radio.

2.15

Talk Permit Tone

In mixed fleet situations (CLP1010 or CLP1040 and CLP1060), Bluetooth users may miss some words due to the unavailability of the Bluetooth connection. Talk Permit Tone allocates some time so that the link between the radio and headset gets reestablished thus minimizing the lost words.



NOTE:

By default the Talk Permit Tone is disabled on Customer Programming Software (CPS) on the Bluetooth models.

This feature is an enhancement feature on CLP Radios and may not be available on previous shipping radios.

Chapter 3

Battery and Charger

This chapter describes the battery and charger feature for the radio.

3.1

Battery Specifications

The radio comes equipped with a rechargeable Lithium-Ion battery. To ensure optimum capacity and performance, the battery should be charged before initial use.

Battery life is determined by several factors. The critical ones are overcharging of batteries and the average depth of discharge each cycle. The greater the overcharge and the deeper the average discharge, the fewer cycles a battery lasts. A battery which is overcharged and discharged 100 % for several times a day, lasts fewer cycles than a battery that overcharges less and is discharged to 50 % per day. Battery with minimal overcharge and has an average of 25 % discharge, lasts even longer.

Motorola Solutions batteries are designed specifically to be used with a Motorola Solutions charger and vice versa. Charging batteries with non-Motorola Solutions equipment may lead to battery damage and void the battery warranty. Whenever possible, maintain the battery temperature to 77 °F (25 °C) (room temperature). Charging a cold battery (below 50 °F [10 °C]) may result in leakage of electrolyte and ultimate failure of the battery. Charging a hot battery (above 95 °F [35 °C]) results in reducing discharge capacity and affecting the performance of the radio. Motorola Solutions rapid-rate battery chargers contain a temperature-sensing circuit to ensure that batteries are charged within the temperature limits.

3.2

Battery Life

The following table specifies the battery life based on 5 % transmit, 5 % receive, and 90 % standby (standard duty cycle).

Table 4: Estimated Battery Life

Standard Charging Solution	Battery Type	
	Standard Lithium-ion Battery	High Capacity Lithium-ion Battery
CLP1010 CLP1040	9 hours	14 hours
CLP1060 Ensure bluetooth is ON mode.	8 hours	12 hours

3.3

Battery Recycling and Disposal

Lithium-ion rechargeable batteries can be recycled. However, recycling facilities may not be available in all areas. Under various U.S. state laws and the laws of several other countries, batteries must be recycled and cannot be disposed of in landfills or incinerators. Contact your local waste management agency for specific

requirements and information in your area. Motorola Solutions fully endorses and encourages the recycling of Lithium-Ion batteries.

In the U.S. and Canada, Motorola Solutions participates in the nationwide Call2Recycle program for battery collection and recycling. Many retailers and dealers participate in this program. For the location of the drop-off facility closest to you, access Call2Recycle's Internet web site at <https://www.call2recycle.org/> or call 1-800-8-BATTERY. The internet site and telephone number also provide other useful information concerning recycling options for consumers, businesses, and governmental agencies.

3.4

Removing the Lithium-Ion Battery

Prerequisites: Ensure the radio is turned off.

Procedure:

1. At the bottom of the battery door, lift the latch up and remove the battery door of the radio.
2. Pull the battery away from the radio.

Figure 5: Battery Removal

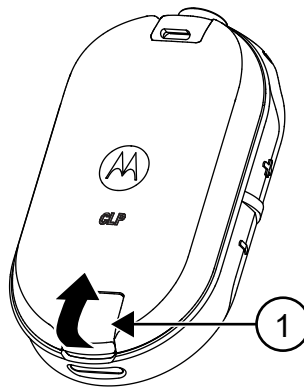

Item Number	Description
1	Battery Latch

3.5

Power Supply, Adapter, and Drop-in Tray Charger

The radio is packaged with one Drop-in Tray Charger with a transformer.

For information on accessories, see [Accessories on page 48](#).

Figure 6: Power Supply, Adapter, and Drop-in Tray Charger

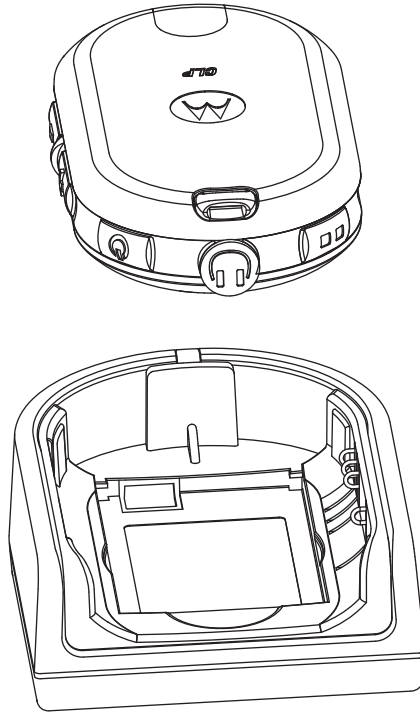

3.6

Stand-Alone Battery

The battery can be charged as a stand-alone battery.

The battery is charged by using either a Single Unit Charger (SUC) or a Multi-Unit Charger (MUC).

 **NOTE:** When acquiring additional chargers or power supplies, ensure that you have a similar drop-in tray chargers and power supplies sets. For more information on accessories, see [Accessories on page 48](#).

Figure 7: Stand-Alone Battery



Item Number	Description
1	Micro-USB port

3.6.1

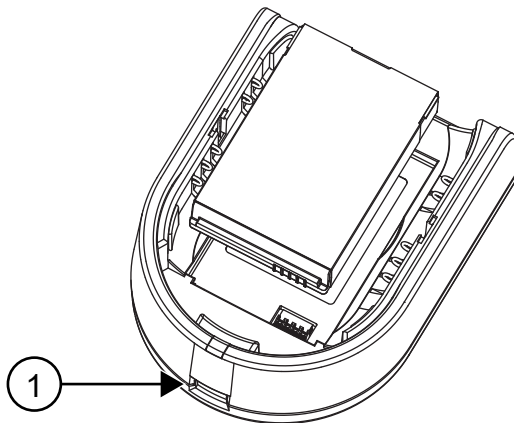
Charging a Stand-Alone Battery with the Drop-in Tray Charger

Procedure:

1. To charge the battery, insert the connector of the power supply into the micro Universal Serial Bus (USB) port on the front of the drop-in tray charger.
2. Connect the power supply to a proper AC outlet.
3. Insert the battery into the tray, with the inside surface of the battery facing the front of the charger. See [Stand-Alone Battery on page 23](#).
4. Ensure that the slots in the battery are correctly engaged in the charger.

3.6.2

Estimated Charging Time

The following tables provide the estimated charging time of the battery.

Table 5: Estimated Charging Time

Charging Solution	Battery Type	
	Standard Lithium-Ion Battery	High Capacity Lithium-Ion Battery
Single Unit Charger	4 hours	5.5 hours
Multi-Unit Charger	2.5 hours	4 hours

3.7

Charging Radio with the Drop-in Tray SUC

Procedure:

1. Place the drop-in Tray Single Unit Charger (SUC) on a flat surface.
2. Insert the connector of the power supply into the Micro USB port on the front of the drop-in tray charger.
3. Connect the correct power supply to a proper AC outlet.
4. Insert the radio with battery installed into the tray, facing down and making sure that the charging contacts on the charger are aligned with the contacts on the radio.

Figure 8: Charging Radio

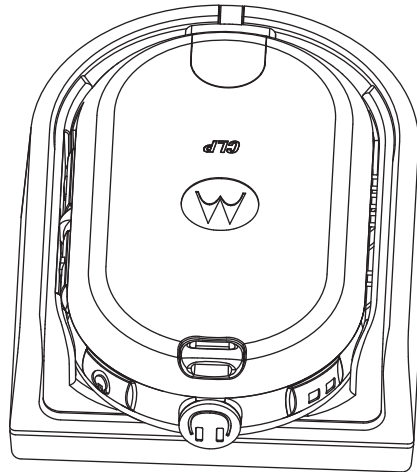

 **NOTE:** When charging a battery attached to a radio, turn the radio off to ensure a full charge. The radio fits in the charger with the holster attached when placed face down in the tray.

3.8

Charging with the Drop-In Tray MUC-Optional Accessory

The Multi-Unit Charger (MUC) allows drop-in charging of up to six radios. Each of the six charging pockets can hold a radio with a battery installed. The MUC provides pockets for headset storage.

Procedure:

1. Place the charger on a flat surface or mount it on the wall.
2. Insert the power cord plug into the jack on the MUC.
3. Plug the cord into an AC outlet and then into the charger.
4. Turn off the radio.
5. Insert the radio facing down with battery installed into the charging pocket, ensuring that the radio contacts are aligned with the MUC contacts.

 **NOTE:** The battery charges on its own by using the slot on the flat surface of the charging pocket.

Figure 9: Charging Radios



3.9

Charger LED Indications

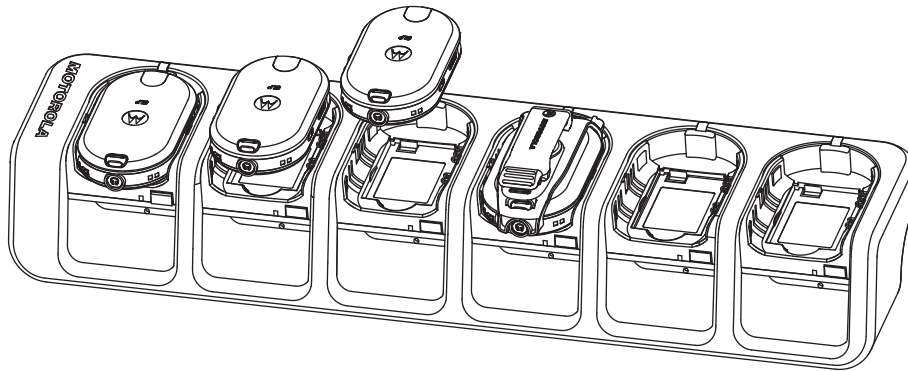
On the drop-in charger, the radio charging pocket has an LED Charger.





On the Multi-Unit Charger (MUC), each of the six charging pockets has an LED. The LEDs are grouped into pairs to indicate which charging pockets are paired.



NOTE: You can clone up to two source radios and two target radios using MUC. For more information on cloning, see [Radio Cloning on page 32](#).

For part number details, see [Accessories on page 48](#).

Table 6: Charger LED Indicator

Status	LED Indication	
Battery is charging  NOTE: The LED is red when the battery is charging. It turns green once the battery is fully charged.	Steady Red	
Battery is fully charged	Steady Green	
Battery Fault ¹	Blinking Red	

3.10

Charging the Bluetooth Headset

Follow the procedure to charge bluetooth headset with CLP Series Drop-In Tray Multi-Unit Charger (MUC) and cloning cable. This is an optional accessory.

¹ Re-seat the battery pack to correct the faulty battery issue.

Procedure:

1. Plug one side of the cloning cable micro-connector to the USB port of the MUC. Six USB ports are available on top of the accessory pockets.
2. Plug the other end of the cloning cable to the USB port of the bluetooth headset for charging.

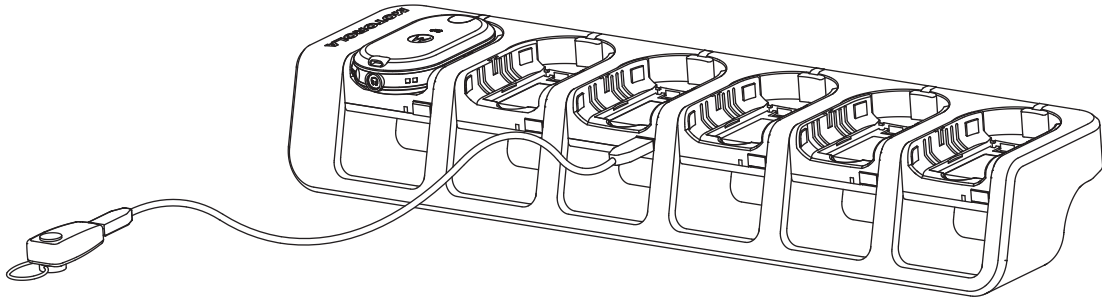

NOTE:

You can also charge your bluetooth headset with CLP Series MUC, part number HKPN4007 (optional accessory) and cloning cable, part number HKKN4026 (optional accessory).

Refer to the charging status light on your bluetooth headset leaflet.

To charge the bluetooth headset, refer to your bluetooth headset leaflet for charging instruction.

3.11





Checking Battery Status

Procedure:

Short press and release the **Power** and **Battery** button.

The Smart Status Glow Ring and Voice Assisted Operation features show the radio battery status.

Table 7: Battery Status

Battery Level	LED Indication	Color
High (70 – 100 %)		Green
Medium (30 – 70 %)		Yellow
Low (10 – 30 %)		Red
Critical (0 – 10 %)		Blinking Red

The radio returns to the current channel color after indicating the battery status.



NOTE: Voice Assisted Operation features may not be available on certain previous shipping radios.

Chapter 4

Radio Programming through CPS

You can program or change features on your radios by using the Customer Programming Software (CPS) and the CPS Programming Cable.

CPS is available for free as web based downloadable software at <http://www.motorolasolutions.com/CLP>.

4.1

Programming the Radio

Prerequisites:

Install the Computer Programming Software (CPS) on your computer.

Ensure that the radio is turned on.

Procedure:

1. Connect the radio by using the Drop-in Charger Tray or the Charging Pocket with **PROG** label on the Multi-Unit Charger and CPS Programming Cable².

Figure 10: Programming the Radio through a Single Unit Charger

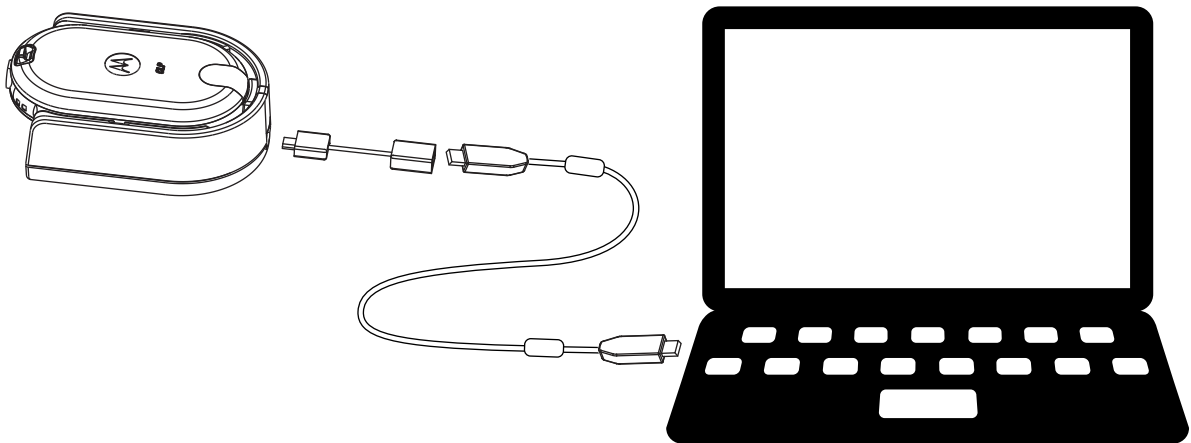

² CPS Programming Cable (P/N HKKN4025_) is an accessory sold separately. Contact your Motorola Solutions Point of Purchase for more information.

Figure 11: Programming the Radio through a Multi-Unit Charger

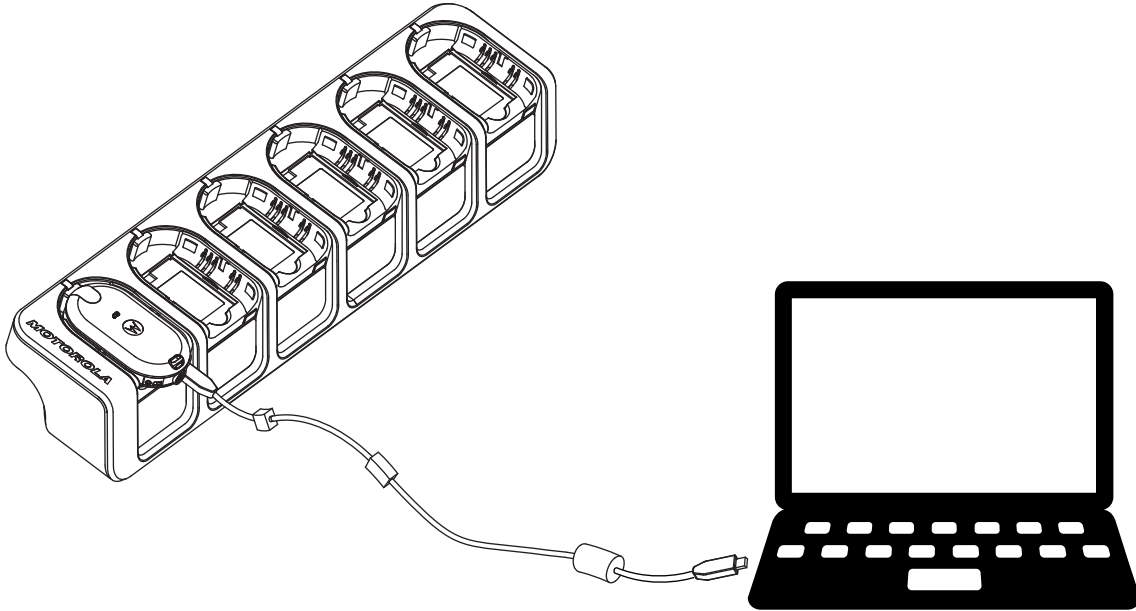

2. After the radio is connected, open the CPS and select **Read** on the toolbar to get the radio profile. You can change the general, audio, menu, channels, scan list, customize PL/DPL settings, bluetooth³ and select frequencies and PL/DPL codes on each channel.
3. To save the settings, select **Write to radio** on the toolbar.

 **NOTE:** For more information on the CPS, see **Help** menu in the CPS.

4.2

Factory Default Settings

Your radio is programmed at the factory to the following settings.

Table 8: CLP1010 1W UHF 1 CH Radios Default Settings-BRUS

Channel Number	Frequency #	Frequency Settings (MHz)	Code Value (Hz)	Bandwidth (kHz)
1	2	464.5500	67.0	12.5

Table 9: CLP1040 1W UHF 4 CH Radios Default Settings-BRUS

Channel Number	Frequency #	Frequency Settings (MHz)	Code Value (Hz)	Bandwidth (kHz)
1	2	464.5500	67.0	12.5
2	8	467.9250	67.0	12.5
3	5	467.8500	67.0	12.5

³ Bluetooth is available in selected models only

Channel Number	Frequency #	Frequency Settings (MHz)	Code Value (Hz)	Bandwidth (kHz)
4	6	467.8750	67.0	12.5

Table 10: CLP1060 1W UHF 6 CH Bluetooth Radios Default Settings-BRUS

Channel Number	Frequency #	Frequency Settings (MHz)	Code Value (Hz)	Bandwidth (kHz)
1	2	464.5500	67.0	12.5
2	8	467.9250	67.0	12.5
3	5	467.8500	67.0	12.5
4	6	467.8750	67.0	12.5
5	10	461.0625	67.0	12.5
6	12	461.1125	67.0	12.5

Chapter 5

Radio Cloning

This feature allows you to clone radio settings from one radio to another.

5.1

Cloning Radio Settings

You can copy the radio settings from the source to another radio.

You can use one of the following unit chargers and cables for cloning:

- CLP Series Single Unit Charger (SUC) kit part number HKPN4008_ and CLP Series Cloning Cable kit part number HKKN4026_ (optional accessory).
- Multi-Unit Charger (MUC) Kit Part Number HKPN4007_ (optional accessory)

A multi-channel radio can be cloned to a single channel radio but only the first channel is cloned. The MUC does not have to be plugged in for cloning, but both radios require charged batteries.



NOTE: The enhanced CLP software also uses the LED to indicate pass or fail status during cloning. Green LED during cloning indicates pass status and red LED during cloning indicates fail status.

5.2

Cloning Radios using the Cloning Cable

Prerequisites: Cloning radios using Multi-Unit Charger (MUC) kit part number HKKN4026_ (optional accessory)

- A fully charged battery on each radio.
- Two Single-Unit Charger (SUC) Kits.
- Both radios are turned off.
- Source radio: Radio to be cloned.
- Target radio: Radio to which the configuration of the source radio is to be copied.

Figure 12: Cloning the Radio through a Single Unit Charger

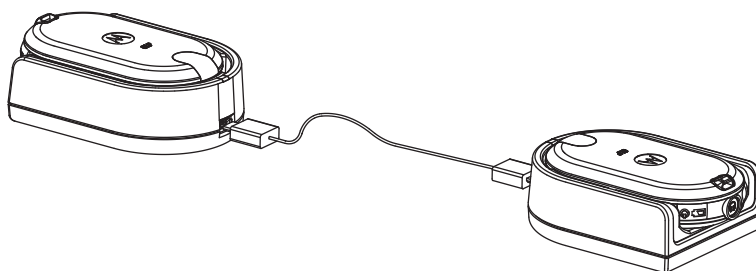

Procedure:

1. Unplug any cables such as power supply or micro USB cables from the SUC.

2. Plug one side of the cloning cable micro USB to one SUC and plug the other end to the second SUC.



NOTE:

During the cloning process, no power is applied to the SUC. The batteries cannot be charged. A data communication is established between the two radios.

3. Turn on the target radio and place it into one of the SUC.
4. To power the source radio, press and hold the **PTT** button and the - button simultaneously while turning on the radio until you hear the cloning tone and the yellow LED double blinks on the smart status glow.
5. To start the cloning process, place the source radio in its SUC with an audio accessory, then press and release the **Menu** button.

If successful, the source radio sounds a good key chirp tone.

If unsuccessful, the source radio sounds bonk tone.

The tone sounds for no more than five seconds.

6. Turn the radios off and on to bring the radios to the user mode by exiting the clone mode when the cloning process is completed.

5.3

Cloning Radios using the Multi-Unit Charger

Prerequisites: Cloning radios using Multi-Unit Charger (MUC) Kit part number HKPN4007_ (optional accessory)

Procedure:

1. To put the source radio into clone mode, press and hold the source radio **PTT** button and the - button simultaneously while turning on the radio until you hear the cloning tone and the yellow LED double blinks on the smart status glow ring.
2. Place the source radio into one of the charging pockets that has the **CLONE** label.
3. Turn on the target radio and place it in the pairing charging pocket that has the **CLONE** label and start the cloning process.
4. To start the cloning process, press the **Menu** button on the source radio.
The source radio generates the start clone tone.
5. To activate the radio, turn off and on the radios when cloning process is completed.
6. To clone another radio, repeat [step 3](#) to [step 5](#).
7. To exit clone mode on the source radio, turn off the radio.

Figure 13: Cloning the Radio through a Multi-Unit Charger

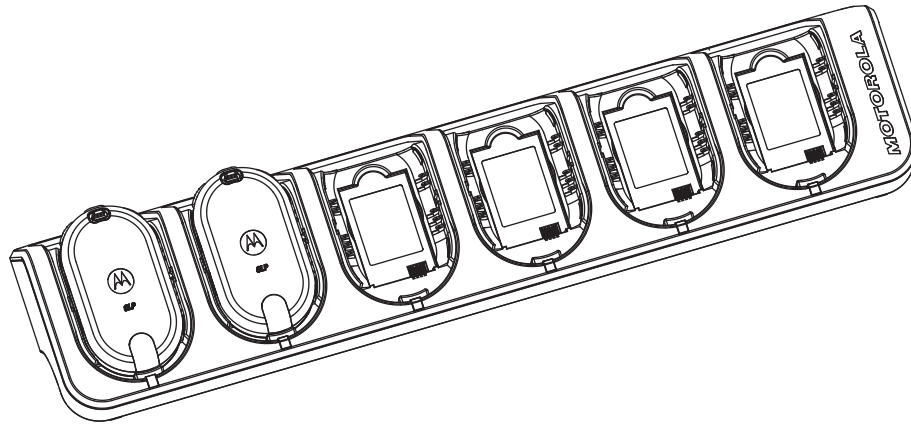

5.4

Troubleshooting Cloning Mode

When and where to use:

The radio audible voice announces “Bonk” indicating that the cloning process has failed. In the event that cloning fails, perform each of the following steps before attempting to start cloning process again.

Procedure:

1. Ensure that the batteries on both radios are fully charged and engaged properly on the radio.
2. Check the cloning cable connection on both Single-Unit Chargers (SUC).
3. Ensure that there is no debris in the charging tray or on the radio contacts and the radio contact is touching the SUC or Multi-Unit Charger (MUC) contact firmly.
4. Ensure that the target radio is turned on.
5. Ensure that the source radio is in cloning mode.
6. Ensure that the two radios are both from the same frequency band, same region and have the same transmission power.



NOTE: The cloning cable is designed to operate only with compatible Motorola Solutions SUC.

Result: When ordering cloning cable kit, ensure to order the cloning cable kit with part number HKKN4026_. For more information about the accessories, see [Accessories on page 48](#).

Chapter 6

Advanced Radio Configuration

Advanced radio configuration feature allows you to configure settings from a pre-programmed list without using a computer.

Advanced configuration mode allows you to customize the following settings:

- Channels
- Frequencies
- Codes (CTCC/DPL)

Frequencies allow you to select frequencies for each channel. **Codes** help minimize interference by providing you with a choice of code combinations that filter out static, noise, and unwanted messages.



NOTE: This feature is an enhancement feature on CLP radios and may not be available on previous shipping radios.

6.1

Entering Advanced Radio Configuration Mode

Prerequisites:



NOTE: For bluetooth models, ensure the wired accessory is connected or the bluetooth headset is paired before entering advanced radio configuration mode.

Turn the radio off.

Procedure:

1. Press the **PTT**, **+** button and **Power** button simultaneously and hold for 3 to 5 seconds until you hear a sound and the voice prompt *Programming Mode*.
The LED blinks green.
2. To select the settings you want to change, press the **Menu** button.
The followings are the settings that you can change:
 - Channel (for multi-channel models)
 - Frequency
 - CodeThe voice announcements indicate the menu items and their current settings.
3. To change the settings, press either the **+** or **-** button.
4. To go to the next menu item, press the **Menu** button.
5. To exit the **Advanced Radio Configuration** mode, press and hold the **PTT** button until you hear a sound.

Chapter 7

Troubleshooting

The following table explains the ways to troubleshoot if the symptom occurs.

7.1

Symptom and Solutions

Procedure:

If...	Then...
No power	Recharge or replace the Li-Ion battery.  NOTE: Extreme operating temperatures may affect battery life. See Battery Specifications on page 21 .
Hearing other noises or conversation on a channel	Frequency or Interference Eliminator Code may be in use. Perform one of the following actions: <ul style="list-style-type: none">• Confirm Interference Eliminator Code is set.• Change frequencies or codes settings on all radios.• Ensure the radio is at the right frequency and code when transmitting.
Message Scrambled	Scramble Code might be on or the setting does not match other radio settings. Change the settings through Customer Programming Software (CPS).
Audio quality not good enough	Radio settings might not be match correctly. Check the frequencies, codes, and bandwidths to ensure the settings are the same in all radios.

If...	Then...
Limited talk range	<p>Perform one of the following actions:</p> <ul style="list-style-type: none"> • Check for clear line of sight to improve transmission. Avoid being near steel, concrete structures, heavy foliage, buildings, or vehicles. • Change the placement of the radio. • To increase range and coverage, you can reduce obstructions or increase power. UHF radios provides greater coverage in industrial and commercial buildings. Increasing power provides greater signal range and increased penetration through obstructions.
Message not transmitted or received	<p>Perform one of the following actions:</p> <ul style="list-style-type: none"> • Ensure the PTT button is completely pressed when transmitting. • Confirm that the radios have the same Channel, Frequency, Interference Eliminator Code, and Scramble Code settings. See Transmitting and Receiving on page 16. • Recharge, replace, or reposition batteries. See Battery Specifications on page 21. • Change the radio placement. Obstructions and operating indoors, or in vehicles, may interfere. . • Verify that the radio is not in Scan mode. See Scanning Radio Channels on page 19.
Heavy static or interference	<p>Radios are too close. Ensure the transmitting and receiving radios are at least 5 feet (1.5 m) apart.</p> <p>Radios are too far apart or obstacles are interfering with transmission.</p>
Low batteries	<p>Recharge or replace Li-Ion battery.</p> <p> NOTE: Extreme operating temperatures affect battery life.</p> <p>See Battery Specifications on page 21.</p>
Drop-in Charger LED light does not blink	<p>Perform one of the following actions:</p> <ul style="list-style-type: none"> • Verify that the radio and battery is properly inserted. • Check the battery and charger contacts to ensure that they are clean and charging pin is inserted correctly. <p>See Charging a Stand-Alone Battery with the Drop-in Tray Charger on page 24 and Charger LED Indications on page 26.</p>

If...	Then...
Cannot activate VOX	VOX feature might be set to off. Use the CPS to ensure the VOX Sensitivity level is not set to 0. Accessory not working or not compatible.
Battery does not charge although it has been placed in the drop-in charger for a while	Perform one of the following actions: <ul style="list-style-type: none"> • Verify the drop-in tray charger is properly connected and corresponds to a compatible power supply. See Charging a Stand-Alone Battery with the Drop-in Tray Charger on page 24. • Check the charger LEDs indicators to see if the battery has a problem. See Charger LED Indications on page 26.
Unable to pair a Bluetooth headset	Ensure the target Bluetooth headset is not connected to another device.
Unable to connect to a Bluetooth headset	Ensure the target Bluetooth headset is not connected to another device.
Pairing with wrong Bluetooth headset	Do not perform pairing procedures next to other Bluetooth headset devices. CLP Bluetooth uses proximity pairing. Ensure the headset is placed next to the CLP radio.

 **NOTE:** When a feature in your radio does not correspond to the default or preprogrammed values, ensure your radio is programmed using CPS with a customized profile.

Chapter 8

Use and Care

This chapter explains the maintenance of the radio.

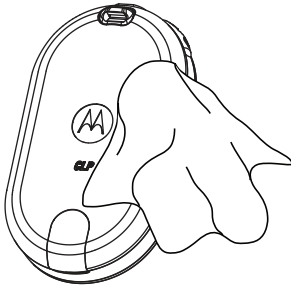

Use a soft damp cloth to clean the exterior



Do not immerse in water

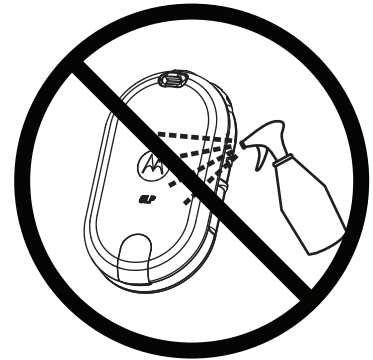

Do not use alcohol or cleaning solutions

If the radio is submerged in water:

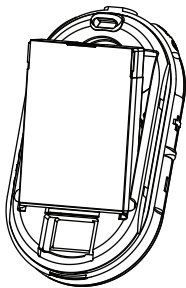

Turn the radio off and remove batteries

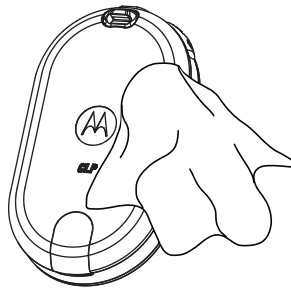

Dry with soft cloth

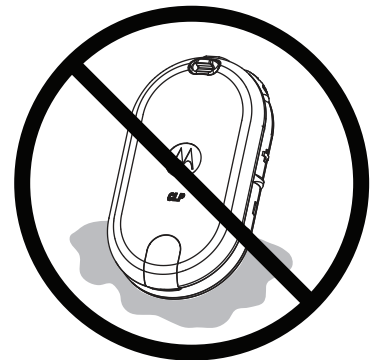

Do not use the radio until it is completely dry

Chapter 9

Radio Frequency and Code Chart

The following tables shows the frequency information and are useful when using Motorola Solutions CLP Series Two-Way Radios with other business radios.

Most of the frequency positions are the same as Spirit M, GT, S, XTN, RDX, and CLS Series frequency positions, the bandwidths are different.

9.1

CLP Frequencies

Table 11: CLP UHF Frequencies

Freq#	Freq (MHz)	Bandwidth (kHz)	Freq#	Freq (MHz)	Bandwidth (kHz)
1	464.5000	12.5	46	466.3375	12.5
2	464.5500	12.5	47	466.3625	12.5
3	467.7625	12.5	48	467.7875	12.5
4	467.8125	12.5	49	467.8375	12.5
5	467.8500	12.5	50	467.8625	12.5
6	467.8750	12.5	51	467.8875	12.5
7	467.9000	12.5	52	467.9125	12.5
8	467.9250	12.5	53	469.4875	12.5
9	461.0375	12.5	54	469.5125	12.5
10	461.0625	12.5	55	469.5375	12.5
11	461.0875	12.5	56	469.5625	12.5
12	461.1125	12.5	57	462.1875	12.5
13	461.1375	12.5	58	462.4625	12.5
14	461.1625	12.5	59	462.4875	12.5
15	461.1875	12.5	60	462.5125	12.5
16	461.2125	12.5	61	467.1875	12.5
17	461.2375	12.5	62	467.4625	12.5
18	461.2625	12.5	63	467.4875	12.5
19	461.2875	12.5	64	467.5125	12.5
20	461.3125	12.5	65	451.1875	12.5
21	461.3375	12.5	66	451.2375	12.5
22	461.3625	12.5	67	451.2875	12.5
23	462.7625	12.5	68	451.3375	12.5

Freq#	Freq (MHz)	Bandwidth (kHz)	Freq#	Freq (MHz)	Bandwidth (kHz)
24	462.7875	12.5	69	451.4375	12.5
25	462.8125	12.5	70	451.5375	12.5
26	462.8375	12.5	71	451.6375	12.5
27	462.8625	12.5	72	452.3125	12.5
28	462.8875	12.5	73	452.5375	12.5
29	462.9125	12.5	74	452.4125	12.5
30	464.4875	12.5	75	452.5125	12.5
31	464.5125	12.5	76	452.7625	12.5
32	464.5375	12.5	77	452.8625	12.5
33	464.5625	12.5	78	456.1875	12.5
34	466.0375	12.5	79	456.2375	12.5
35	466.0625	12.5	80	456.2875	12.5
36	466.0875	12.5	81	468.2125	12.5
37	466.1125	12.5	82	468.2625	12.5
38	466.1375	12.5	83	468.3125	12.5
39	466.1625	12.5	84	468.3625	12.5
40	466.1875	12.5	85	468.4125	12.5
41	466.2125	12.5	86	468.4625	12.5
42	466.2375	12.5	87	468.5125	12.5
43	466.2625	12.5	88	468.5625	12.5
44	466.2875	12.5	89	468.6125	12.5
45	466.3125	12.5	90	468.6625	12.5

9.2

CTCSS/DPL Interference Eliminator Codes

Table 12: CTCSS/DPL Interference Eliminator Codes

CTCSS	Code	CTCSS/D PL	Code	DPL	Code	DPL	Code	DPL	Code
0	Disabled	24	151.4	47	54	71	243	95	445
1	67.0	25	156.7	48	65	72	244	96	464
2	71.9	26	162.2	49	71	73	245	97	465
3	74.4	27	167.9	50	72	74	251	98	466
4	77.0	28	173.8	51	73	75	261	99	503
5	79.7	29	179.9	52	74	76	263	100	506
6	82.5	30	186.2	53	114	77	265	101	516

CTCSS	Code	CTCSS/D PL	Code	DPL	Code	DPL	Code	DPL	Code
7	85.4	31	192.8	54	115	78	271	102	532
8	88.5	32	203.5	55	116	79	306	103	546
9	91.5	33	210.7	56	125	80	311	104	565
10	94.8	34	218.1	57	131	81	315	105	606
11	97.4	35	225.7	58	132	82	331	106	612
12	100.0	36	233.6	59	134	83	343	107	624
13	103.5	37	241.8	60	143	84	346	108	627
14	107.2	38	250.3	61	152	85	351	109	631
15	110.9	122	69.3	62	155	86	364	110	632
16	114.8	39	23.0	63	156	87	365	111	654
17	118.8	40	25.0	64	162	88	371	112	662
18	123.0	41	26.0	65	165	89	411	113	664
19	127.3	42	31.0	66	172	90	412	114	703
20	131.8	43	32.0	67	174	91	413	115	712
21	136.5	44	43.0	68	205	92	423	116	723
22	141.3	45	47.0	69	223	93	431	117	731
23	146.2	46	51.0	70	226	94	432	118	732
								119	734

Table 13: CTCSS/DPL Interference Eliminator Codes (Continued)

DPL	Code	DPL	Code	DPL	Code	DPL	Code
120	743	146	Inverted DPL 55	171	Inverted DPL 80	195	Inverted DPL 104
121	754	147	Inverted DPL 56	172	Inverted DPL 81	196	Inverted DPL 105
123	645	148	Inverted DPL 57	173	Inverted DPL 82	197	Inverted DPL 106
124	Custom- ized PL	149	Inverted DPL 58	174	Inverted DPL 83	198	Inverted DPL 107
125	Custom- ized PL	150	Inverted DPL 59	175	Inverted DPL 84	199	Inverted DPL 108
126	Custom- ized PL	151	Inverted DPL 60	176	Inverted DPL 85	200	Inverted DPL 109
127	Custom- ized PL	152	Inverted DPL 61	177	Inverted DPL 86	201	Inverted DPL 110
128	Custom- ized PL	153	Inverted DPL 62	178	Inverted DPL 87	202	Inverted DPL 111
129	Custom- ized PL	154	Inverted DPL 63	179	Inverted DPL 88	203	Inverted DPL 112
130	Inverted DPL 39	155	Inverted DPL 64	180	Inverted DPL 89	204	Inverted DPL 113

DPL	Code	DPL	Code	DPL	Code	DPL	Code
131	Inverted DPL 40	156	Inverted DPL 65	181	Inverted DPL 90	205	Inverted DPL 114
132	Inverted DPL 41	157	Inverted DPL 66	181	Inverted DPL 90	206	Inverted DPL 115
133	Inverted DPL 42	158	Inverted DPL 67	182	Inverted DPL 91	207	Inverted DPL 116
134	Inverted DPL 43	159	Inverted DPL 68	183	Inverted DPL 92	208	Inverted DPL 117
135	Inverted DPL 44	160	Inverted DPL 69	184	Inverted DPL 93	209	Inverted DPL 118
136	Inverted DPL 45	161	Inverted DPL 70	185	Inverted DPL 94	210	Inverted DPL 119
137	Inverted DPL 46	162	Inverted DPL 71	186	Inverted DPL 95	211	Inverted DPL 120
138	Inverted DPL 47	163	Inverted DPL 72	187	Inverted DPL 96	212	Inverted DPL 121
139	Inverted DPL 48	164	Inverted DPL 73	188	Inverted DPL 97	213	Inverted DPL 123
140	Inverted DPL 49	165	Inverted DPL 74	189	Inverted DPL 98	214	Customized DPL
141	Inverted DPL 50	166	Inverted DPL 75	190	Inverted DPL 99	215	Customized DPL
142	Inverted DPL 51	167	Inverted DPL 76	191	Inverted DPL 100	216	Customized DPL
143	Inverted DPL 52	168	Inverted DPL 77	192	Inverted DPL 101	217	Customized DPL
144	Inverted DPL 53	169	Inverted DPL 78	193	Inverted DPL 102	218	Customized DPL
145	Inverted DPL 54	170	Inverted DPL 79	194	Inverted DPL 103	219	Customized DPL

Chapter 10

Motorola Solutions Limited Warranty for the United States and Canada

10.1

Warranty

Subject to the exclusions contained below, Motorola Solutions, Inc. warrants its two way radios to be free from defects in materials and workmanship under normal consumer usage for the period(s) outlined.

This limited warranty is a consumer's exclusive remedy, and applies as follows to new Motorola Solutions Products, Accessories and Software purchased by consumers in Latin American countries, which are accompanied by this written warranty.

10.2

Products and Accessories

The table shows the length of coverage of products and accessories.

Table 14: Products and Accessories

Products Covered	Length of Coverage
Products and accessories as defined above, unless otherwise provided for below	One (1) year from the date of purchase by the first purchaser of the product unless otherwise provided for below.
Decorative accessories and cases. Decorative covers, bezels, PhoneWrap™ covers and cases	Limited lifetime warranty for the lifetime of ownership by the first purchaser of the product.
Business two-way radio accessories	One (1) year from the date of purchase by the first purchaser of the product.
Products and accessories that are repaired or replaced	The balance of the original warranty or for 90 days from the date returned to the consumer, whichever is longer.
Two-way radio	Two (2) years from the date of purchase by the first purchaser of the product.

10.3

Exclusions

Normal Wear and Tear

Periodic maintenance, repair and replacement of parts due to normal wear and tear are excluded from coverage.

Batteries

Only batteries whose fully charged capacity falls below 80% of their rated capacity and batteries that leak are covered by this limited warranty.

Abuse and Misuse

Defects or damage that result from:

- improper operation, storage, misuse or abuse, accident or neglect, such as physical damage (cracks, scratches, etc.) to the surface of the product resulting from misuse
- contact with liquid, water, rain, extreme humidity or heavy perspiration, sand, dirt or the like, extreme heat, or food
- use of the Products or Accessories for commercial purposes or subjecting the Product or Accessory to abnormal usage or conditions
- other acts which are not the fault of Motorola Solutions, are excluded from coverage.

Use of Non-Motorola Solutions Products and Accessories

Defects or damage that result from the use of Non-Motorola Solutions branded or certified Products, Accessories, Software or other peripheral equipment are excluded from coverage.

Unauthorized Service or Modification

Defects or damages resulting from service, testing, adjustment, installation, maintenance, alteration, or modification in any way by someone other than Motorola Solutions, or its authorized service centers, are excluded from coverage.

Altered Products

Products or Accessories with:

- serial numbers or date tags that have been removed, altered or obliterated
- broken seals or that show evidence of tampering
- mismatched board serial numbers
- nonconforming or non-Motorola Solutions housings, or parts, are excluded from coverage

Communication Services

Defects, damages, or the failure of Products, Accessories or Software due to any communication service or signal you may subscribe to or use with the Products Accessories or Software is excluded from coverage.

10.4

Software**Table 15: Software Warranty Table**

Products Covered	Length of Coverage
Software Applies only to physical defects of the media that embodies the copy of the software.	90 days from the date of purchase.

Exclusions**Software Embodied in Physical Media**

The warranty does not cover that the software will meet your requirements or will work in combination with any hardware or software applications provided by third parties, that the operation of the software products will be uninterrupted or error free, or that all defects in the software products will be corrected.

Software not Embodied in Physical Media

Software that is not embodied in physical media (for example, software downloaded from the internet), is provided “as is” and without warranty.

10.5

Warranty Coverage

This warranty extends only to the first consumer purchaser, and is not transferable.

10.6

Warranty and Service Support

Motorola Solutions have the option to repair or replace the Products or software that do not conform to the warranty, or to refund the Products' purchase price at no charge.

We may use functionally equivalent re-conditioned/refurbished/pre-owned or new Products or parts. No software updates are provided.

10.7

Retain Your Original Proof of Purchase

Motorola Solutions will ship repaired or replacement Products at our expense for the freight and insurance, but at your expense for any duties.

If additional information is needed, contact your Motorola Solutions point of purchase.

10.8

How to Obtain Warranty Service or Other Information

Contact your Motorola Solutions point of purchase.

- 1-800-448- 6686 in the USA
- 1-800-461-4575 in Canada
- 1-866-522-5210 on your TTY (Text Telephone)

You must ship the Products to us with freight, duties and insurance prepaid. Along with the Products you must include:

- a copy of your receipt, bill of sale or other comparable proof of purchase
- a written description of the problem
- the name of your service provider (if this Product requires subscription service)
- the name and location of the installation facility (if applicable) and, most importantly
- your address and telephone number. If requested, you must also return all detachable parts such as antennas, batteries and chargers.

10.9

Software Copyrights Notice

The Motorola Solutions products described in this manual may include copyrighted Motorola Solutions computer programs stored in semiconductor memories or other media. Laws in the United States and other countries preserve for Motorola Solutions certain exclusive rights for copyrighted computer programs including, but not limited to, the exclusive right to copy or reproduce in any form the copyrighted computer program. Accordingly, any copyrighted Motorola Solutions computer programs contained in the Motorola

Solutions products described in this manual may not be copied, reproduced, modified, reverse-engineered, or distributed in any manner without the express written permission of Motorola Solutions.

Furthermore, the purchase of Motorola Solutions products shall not be deemed to grant either directly or by implication, estoppel, or otherwise, any license under the copyrights, patents or patent applications of Motorola Solutions, except for the normal non-exclusive license to use that arises by operation of law in the sale of a product.

10.10

Patent Notice

This product is covered by one or more of the following United States patents.

5896277 5894292 5864752 5699006 5742484 D408396 D399821 D387758 D389158 5894592 5893027
5789098 5734975 5861850 D395882 D383745 D389827 D389139 5929825 5926514 5953640 6071640
D413022 D416252 D416893 D433001

10.11

Export Law Assurances

This product is controlled under the export regulations of the United States of America. The Government of the United States of America may restrict the exportation or re-exportation of this product to certain destinations.

For further information, contact the U.S. Department of Commerce.

Chapter 11

Accessories

Table 16: Audio Accessories

Part No.	Description
HKLN4529_	CLP Series Short Cord Earpiece, Single Pin
HKLN4455_/HKLN4602_	CLP Series Non-Adjustable PTT Earpiece, Single Pin
HKLN4487_/HKLN4603_	CLP Series Surveillance Earpiece, Single Pin

Table 17: Batteries

Part No.	Description
HKNN4013_	CLP Series High Capacity Li-Ion Battery Kit
HKNN4014_	CLP Series Standard Li-Ion Battery Kit
HKLN4440_	CLP High Capacity Li-Ion Battery Door Kit
HKLN4441_	CLP Standard Li-Ion Battery Door Kit

Table 18: Carry Accessories

Part No.	Description
HKLN4433_	CLP Series Magnetic Case ⁴
HKLN4438_	CLP Series Swivel Belt Clip Holster

Table 19: Chargers

Part No.	Description
HKPN4007_	CLP Series Multi-Unit Charger (MUC) Kit
HKPN4008_	CLP Series Single Unit Charger (SUC) Kit

Table 20: Programming Cables

Part No.	Description
HKKN4027_	CPS Cable Kit
HKKN4028_	CLP Series Cloning Cable Kit

Contacts

For product-related questions, contact:

⁴ Certain accessories may be or may not be available at the time of purchase. For latest information on accessories, contact your Motorola Solutions point of purchase or visit: <http://www.motorolasolutions.com/CLP>

- 1-800-448- 6686 in the USA
- 1-800-461-4575 in Canada
- 1-866-522-5210 on your TTY (Text Telephone)