



MOTOROLA

*MTM800E 260MHz
TETRA Mobile Terminal
Feature User Guide*



When printed by Motorola

Contents

General Information	1
Safety Information	1
Disposal Information	1
Copyright Information	2
Product Specific Information	2
Icon Conventions	3
Getting Started	5
How to Use this Guide	5
Controls and Indicators	6
Uninstalling the Radio	8
Powering On/Off (On-Off/End/Home Key or Rotary Knob Push Button)	9
Powering On (Emergency Button)	9
Powering On with Transmit Inhibit (TXI) Active	9
Unlocking the MTM800E	10
Locking/Unlocking the Keys/Buttons	10
Selecting Your Network	11
RUA/RUI	11
Looking After Your MTM800E	11
The Display	12
The LED Status Indicator	15
Key, Knob, and Button Overview	16
Aliases (Names)	20
Screen Saver	21
Home Display Text Message	22
Time & Date	22
Terminal Disable/Enable	22
Terminal Permanent Disable	23
Selecting TMO or DMO Operation	23
PTT Double Push	25
Individual Call	25
Modifying the Type of Call	26
Receiving Calls	27
Pre-emptive Calling	27

Broadcast Call	29
Ambience Listening (AL)	29
Cancelling a Call	30
Using In-call Features	30
Covert Mode	31
Local Area Service	31
Packet Data	32
Dual Control Head	33
TMO Group Call	35
General	35
Selecting a Group	36
Selecting a Group using Navigation Keys / Alphabetic Search / Folder Search	38
Selecting a Folder	39
“My Groups” Folders	39
Group Scrolling Configuration	40
Activating/Deactivating Scanning	40
Making a Group Call	41
Receiving a Group Call	41
Transmit Inhibit	44
Dynamic Group Number Assignment (DGNA)	44
DMO Group Call	47
General	47
Favorite Folders	48
Selecting a Group	48
Selecting a Group using Navigation Keys / Alphabetic Search / Folder Search	48
Selecting a Folder	48
Group Scrolling Configuration	48
Gateway/Repeater Selection	49
Making a DMO Group Call (MS to MS)	52
Making a DMO Group Call via Gateway	53
Making a DMO Group Call via Repeater	53
Making a DMO Group Call via Gateway and Repeater	54
Receiving a DMO Group Call	55
DMO Private Call	56
Emergency Group Call	56

Exiting DMO	57
Private Call	59
General	59
Making a Private Call in TMO	59
Other Ways of Dialing	60
Receiving a Private Call in TMO	62
Private Call in DMO	62
Dialing on Receiving a Call	63
Making a Private PPC (Pre-emptive Priority Call)	64
Call Queuing	64
Phone and PABX Calls	65
General	65
Making a Phone or PABX Call	65
Other Ways of Dialing	66
Answering a Phone or PABX Call	68
Emergency Operation	69
General	69
Emergency in TMO	71
Silent Emergency Mode	77
Emergency in DMO	78
Using the Browser	81
Icons	81
Entering/Exiting the Browser	81
Browser Menu Pane Contents	86
Keys Usage	87
Browser Menu Panes Overview	88
Navigate Pane	89
Bookmarks Pane	91
History Pane	93
Options Pane	94
Image Pane	94
Text Input Pane	94
WAP Box	95
GPS Location Service	99
Enhancing GPS Performance	100

GPS Icon	101
GPS Enable/Disable	101
Entering GPS Location Service	101
The Menu	105
To Enter the Menu Items	105
To Return to the Previous Level	105
To Exit the Menu Items	106
Menu Icons	106
List of Menu Items	107
Messages	110
Contacts	110
Security	113
Setup	120
Entering More...	131
Entering Group Setup	131
Entering Scan	131
My Groups (TMO/DMO)	135
Viewing/Modifying Personal Information	137
Recent Calls	138
Shortcuts	140
RUI	142
Networks	145
Location	148
Packet Data	148
Messages	151
General	151
Entering the Messages Sub-menu	152
New Message	153
Using the Inbox	154
Calling a Number in a Message	157
User Defined Templates	159
Predefined Templates	160
Sending a Status Message to a Group	161
Targeted Status	162
Long Text Messages	163
Store & Forward	163
Call-Out	163

WAP Box	165
Writing Text	167
Selecting the Text Entry Mode	167
Adding Secondary to the List of Text Entry Modes	167
Selecting the Text Entry Method and Language	167
Icons	168
TAP Display	169
iTAP Display	169
Tap Hiragana Display	169
Keys Usage	170
Writing in iTAP Alphanumeric	175
Writing in Tap Hiragana	176
Writing in Numeric Mode	176
Writing in Symbol Mode	177
Writing in TAP Alphanumeric	177
Adding Words to the Dictionary	177
What to do if...	179
Tones	185
Index	189
Quick Reference Guide	195

© Motorola Inc., 2010

MOTOROLA and the Stylized M Logo are registered in the U.S. Patent and Trademark Office. All other product or service names are the property of their respective owners.

General Information

Safety Information

	CAUTION	<i>Before using these products, read the operating instructions for safe usage contained in the Product Safety and RF Exposure booklet 6804113J25.</i>
-----------------------------------------------------------------------------------	----------------	--------------------------------------------------------------------------------------------------------------------------------------------------------

The MTM800E is restricted to occupational use only to satisfy ICNIRP RF energy exposure requirements. Before using the products, read the RF energy awareness information and operating instructions in the Product Safety and RF Exposure booklet (Motorola Publication part number Safety Leaflet 6804113J25) to ensure compliance with RF energy exposure limits.

Keep this **User Guide** and the **Product Safety and RF Exposure booklet** in a safe place and make it available to other operators in case the accessories are passed on to other people.

Disposal Information



The **European Union Waste of Electrical and Electronic Equipment** directive requires that products sold into EU countries must have the crossed out trashbin label on the product (or the package in some cases). As defined by the WEEE directive, this cross-out trashbin label means that customers and end-users in EU countries should not dispose of electronic and electrical equipment or accessories in household waste.

Customers or end-users in EU countries should contact their local equipment supplier representative or service centre for information about the waste collection system in their country.

Copyright Information

The Motorola products described in this manual may include copyrighted Motorola computer programs stored in semiconductor memories or other mediums. Laws in the United States and other countries preserve for Motorola certain exclusive rights for copyrighted computer programs, but not limited to, including the exclusive right to copy or reproduce in any form the copyrighted computer program. Accordingly, any copyrighted Motorola computer programs contained in the Motorola products described in this manual may not be copied, reproduced, modified, reverse-engineered, or distributed in any manner without the express written permission of Motorola. Furthermore, the purchase of Motorola products shall not be deemed to grant either directly or by implication, estoppel, or otherwise, any licence under the copyrights, patents, or patent applications of Motorola, except for the normal non-exclusive licence to use that arises by operation of the law in the sale of a product.

Product Specific Information

- Max RF Power 3.16 Watts
- Max. Speaker Load 10 Watts at 4 Ohms
- Antenna Impedance 50 Ohms
- Ambient Temperature Range - 30 °C to + 60 °C



WARNING

If the terminal is in service, the surface temperature can rise up to 70 °C.

Do not touch the hot surface

- Operating Time Continuous / Intermittent

NOTE

In general, the terminal transmit and receive time (operating cycle time) is determined by the communication system. On overload, respectively on extensive use beyond the systems specifications at high ambient temperatures, the terminal is protected by its thermal control, which cuts down the RF output power, thus reducing the terminal coverage range.

Icon Conventions

The document set is designed to give the reader more visual cues. The following graphic icons are used throughout the documentation set. These icons and their associated meanings are described below.



WARNING

The signal word Warning with the associated safety icon implies information that, if disregarded, could result in death or serious injury, or serious product damage.



CAUTION

The signal word Caution with the associated safety icon implies information that, if disregarded, may result in minor or moderate injury, or serious product damage.

CAUTION

The signal word Caution may be used without the safety icon to state potential damage or injury that is not related to the product.

NOTE

Notes contain information more important than the surrounding text, such as exceptions or preconditions. They also refer the reader elsewhere for additional information, remind the reader how to complete an action (when it's not part of the current procedure, for instance), or tell the reader where something is located on the screen. There is no warning level associated with a Note.

Getting Started

Congratulations on your purchase of the Motorola MTM800E. Enhanced TETRA features and state-of-the-art technology help to keep you in constant touch with all of your work and personal contacts.

You can operate your MTM800E in English, Japanese or in a language defined by your Service Provider. The default setting from factory is English. For more information, please see "Setting the Display's Working Language" on page 121.

How to Use this Guide

This guide describes the MTM800E features as setup and pre-programmed at the factory.

Your Service Provider or your organisation may have customised your MTM800E to optimise its use for your individual needs. Check with your Service Provider or organisation to find out the differences from this guide.

Throughout the text in this publication, you will notice the following special notations used to highlight certain information or items:

Example	Description
 or Select	Key presses are shown as a key symbol or in bold print for soft key functions.
More... > Networks > TXI Mode > Activate	Indicates navigation in menu items.
Contacts	Highlighted text indicates the selection.
✓ On	Indicates the active setting.
Status Delivered	Information appearing on the MTM800E display is shown in special print.
<User Defined>	Indicates a prompt or message configured by your Service Provider.

Controls and Indicators

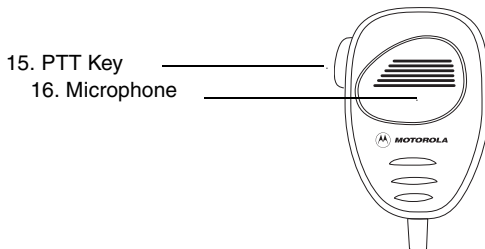
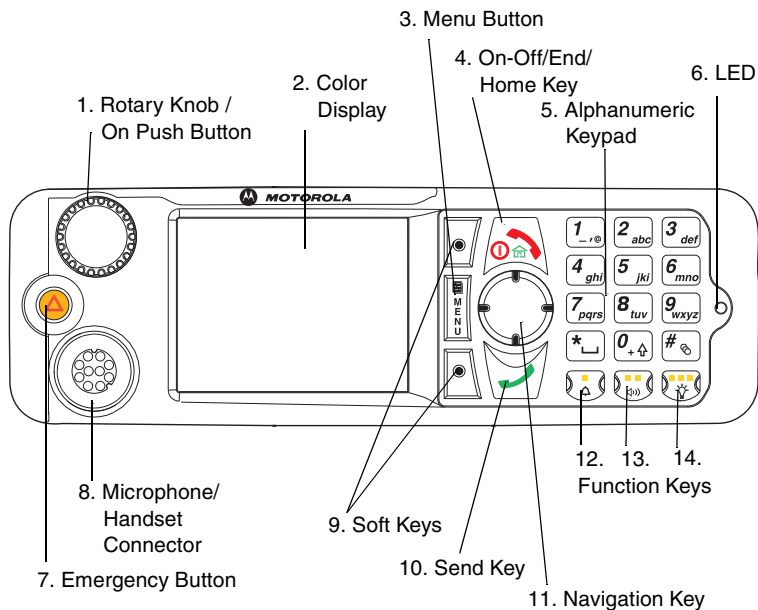

Item	Description
1	Programmable Rotary Knob / On Push Button Default programming: "Dual" - Press the knob to toggle between "volume" and "list". Press and hold to turn the MTM800E on.

Item	Description
2	<p>Colour Display Provides alphanumeric text and images within 65,536 colours and 640 x 480 pixels with backlighting and scalable fonts.</p>
3	<p>Menu Button Used to enter the main menu and the context sensitive menu.</p>
4	<p>On-Off/End/Home Key</p> <ul style="list-style-type: none"> • Press and hold to turn the MTM800E On/Off. • Press to end calls. • Press to return to the Home display (idle screen).
5	<p>Alphanumeric Keypad Use the keypad to enter alphanumeric characters for dialing, contact entries and text messages.</p>
6	<p>LED (Indicator)</p>
7	<p>Emergency Button Press and hold to enter Emergency mode, and send Emergency Alarms (as programmed). Press and hold to start an Emergency Private Call (Simplex or full-duplex). When the MTM800E is Off, press and hold to power on in Emergency Operation or in standard mode (as programmed).</p>
8	<p>Mobile Microphone Port Provides connection for accessories such as fist microphone with PTT button.</p>
9	<p>Soft Key(s) Press to select the option that appears in the display directly next to the upper or lower soft key.</p>
10	<p>Send Key Used to initiate or answer full-duplex calls (such as Phone Calls), or send status and text messages.</p>

Item	Description
11	Four Way Navigation Key Press up, down, left or right for list scrolling, while moving around the menu hierarchy, or for alphanumeric text editing.
12	Programmable External Alarm Key Default function: Used to activate and deactivate the External Alarm (Horn & Lights).
13	Programmable Speaker Control Key Default function: Switch speaker On/Off.
14	Programmable Backlight Key Used to dim or intensify the radio's backlight. It has five intensity options.
15	Push-To-Talk Button (PTT) Press and hold this side button to talk in Simplex calls or to initiate a group call, release it to listen. Press to send status and text messages.
16	Microphone

NOTE Before using your MTM800E for the first time, remove the plastic lens protector from the display.

NOTE It is recommended to turn off the terminal before connecting any of the accessories.

Uninstalling the Radio



CAUTION

OPTION 1:

Before disconnecting the 13.2V main power supply from the radio:

1. Switch off the radio.
2. Wait for a minimum of 4 seconds after the radio Off Switch is released.

Disconnect the 13.2V main power supply.

OPTION 2:

Turn off the main power supply WITHOUT switching OFF the radio.



Powering On/Off (On-Off/End/Home Key or Rotary Knob Push Button)

To power on:

- Press and hold  or the **On** push button
- If the MTM800E is configured with ignition sense, the radio will automatically turn on whenever the vehicle ignition is turned on.
- If an Emergency Foot Switch is connected to the accessory connector and “Emergency with wake up” is enabled by your Service Provider, the MTM800E automatically turns on in Emergency Mode whenever the Emergency Switch is pressed (see Emergency in TMO” on page 71. and Emergency in DMO” on page 78.).

Your MTM800E performs a self-check and registration routine. After successful registration, the MTM800E is in service.

To power off:

- Press and hold .
- If the radio is powered on via the ignition, it can be turned off via the ignition or press and hold .

You will see the **Powering Off** message.

NOTE *The terminal powers On and Off without visible and audible notification if Covert Mode is activated. (Refer to Covert Mode” on page 31..)*

Powering On (Emergency Button)

Press and hold the Emergency button to power **On**.

The MTM800E will power **On** in Emergency Operation or in standard mode (as programmed).

Powering On with Transmit Inhibit (TXI) Active

Transmit Inhibit is a feature allowing you to switch off transmission before entering a Radio-Frequency (RF) sensitive area.

To activate this feature, press **Menu** and select **More... > Networks > TXI Mode > Activate**.



WARNING

*Pressing the Emergency button, even if Transmit Inhibit is activated, causes the MTM800E to transmit immediately. The MTM800E must **NOT** be within the RF sensitive area when entering Emergency Operation.*

The TXI Mode remains active at power **On**. You will be asked whether to leave the TXI Mode **On** or not.



WARNING

Ensure you have left the RF sensitive area before deactivating Transmit Inhibit.

Press the **Yes** key to deactivate the TXI Mode. If the MTM800E was previously used in Trunked Mode, it will register to the network. If the MTM800E was previously used in Direct Mode, it will remain in Direct Mode.

Press **No** in Trunked Mode and the MTM800E powers down; press **No** in DMO and you remain in DMO with TXI selected.

Unlocking the MTM800E

Your MTM800E may be locked at power up.

To unlock the MTM800E after powering on, enter the code at the prompt. The MTM800E enters the default Home display.

The unlock code is originally set to 0000. Your Service Provider may change this number before you receive your terminal.

Locking/Unlocking the Keys/Buttons

Press **Menu** and . For detailed information, see "Locking/Unlocking the Keypad" on page 115.

NOTE

The Emergency button is not locked. Pressing the Emergency button unlocks all keys.

Selecting Your Network

Before you start operating your MTM800E, you can select the network you want your MTM800E to be registered to. For detailed information, see “Networks” on page 145..

RUA/RUI

Radio User Assignment (RUA) & Radio User Identity (RUI) is providing logon authentication service. It gives flexibility to the user to have the same possibilities with any radio as with a personal issued radio. To use full access to the system user needs to provide the login with the PIN number.

To login go to **Menu > More... > RUI > Log on**

You will see the screen as illustrated, where you can type your **User ID** (up to 16 alphanumeric characters) and **User PIN** (up to 6 numeric characters). Press **Select** to login. You should see the display with Log On Accept.

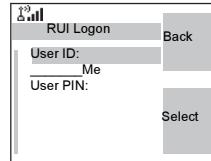

NOTE All the time the display indicates if the user is logged on (blue color of the icon) or logged off (grey color of the icon).

Looking After Your MTM800E

To clean your MTM800E, use a moistened or antistatic cloth. DO NOT use a dry or electrostatically charged cloth.

The Display

Home (Idle) Display



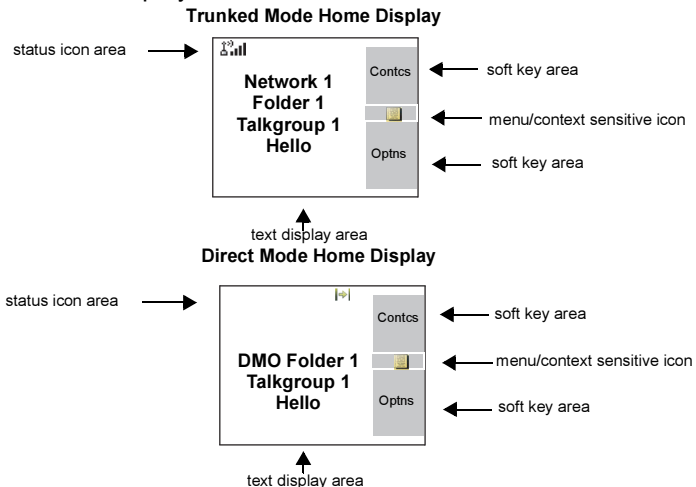



A powered-on, idle terminal shows the following typical Home display:



















Status Icons

Status icons appear when your phone is engaged in certain activities or when you have activated certain features.

Status Icon	Description
Trunked Mode Operation	
	Signal Strength (TMO) Allows you to check signal strength. More bars indicate a stronger signal.
	No Service
	Scan Indicates scanning is activated in the MTM800E.

Status Icon	Description
	<p>Data Connected Displayed when the MTM800E is successfully connected to an external device and ready for data transfer.</p>
	<p>Data Transmit/Receive Displayed when the MTM800E is transferring data to/receiving data from the external device (laptop or desktop PC). No number – standby data session. Number 1, 2, 3, or 4 – indicates active data session with 25%, 50%, 75%, or 100% bandwidth.</p>
Direct Mode Operation	
	<p>Signal Strength (DMO) Indicates an incoming Direct Mode Group Call.</p>
	<p>Direct Mode Displayed when the MTM800E is in Direct Mode.</p>
	<p>DMO Gateway Indicates that gateway is selected. The icon has three states: Solid – while the MTM800E is synchronised with the gateway. Flashing – while the MTM800E is not synchronised or during attachment. No icon – during a terminal to terminal and repeater call.</p>
	<p>DMO Repeater Displayed when the repeater option in DMO is selected. This icon has three states: Solid – while the terminal has detected the repeater (i.e., when the terminal receives a presence signal). Blinking – while the terminal has not detected the repeater or during attachment. No icon – during a terminal to terminal and gateway call.</p>

Status Icon	Description
General Icons	
	<p>All Tones Off / Duplex & Simplex Ring Muted Indicates that all alert tones are off in the MTM800E or both Simplex Ring volume is set to 0 and Duplex Ring volume is set to 0.</p>
	<p>Simplex Ring Muted Indicates that Simplex Ring volume is set to 0 and Duplex Ring volume is set to more then 0.</p>
	<p>Duplex Ring Muted Indicates that Duplex Ring volume is set to 0 and Simplex Ring volume is set to more then 0.</p>
	<p>Speaker Off Indicates that the audio will not sound through the speaker.</p>
	<p>RUI Pseudo Log On Indicates that the user is pseudo logged on.</p>
	<p>Emergency Appears while the MTM800E is in Emergency Operation.</p>
	<p>List Scrolling Displayed to indicate that the Rotary knob use is list scrolling, as long as this use is selected.</p>
	<p>New Message Has Arrived Indicates a new message just arrived.</p>
	<p>New Message(s) in Inbox Indicates that you have unread messages in your Inbox.</p>
	<p>Unread (New) WAP Message Indicates that you have not read the WAP message yet. (Blinks when the priority is high)</p>
	<p>Unread (New) WAP Message Indicates that you need to enter the browser to view the message</p>

Status Icon	Description
	GPS Indicates that your MTM800E is receiving valid GPS location data.
	Dual Control Head Indicates that Master and Slave Control Head are powered on and connected.
	Single Control Head Indicates on Master Control Head that Slave Control Head is switched off.
	Link Error Indicates on Master Control Head that Slave Control Head is unavailable as a result of error, not powered off.
	Key Press Token (Dual Control Head) Indicates by blinking that key press token is reserved by one of the Control Heads.



The LED Status Indicator

The LED indicator shows the in-service states of your MTM800E. Please refer to the table below.

Indicator	Status
Solid GREEN	In use
Flashing GREEN	In service
Solid RED	Out of service
Flashing RED	Connecting to a network / Entering DMO
Solid ORANGE	Transmit Inhibit (TXI) in service / Channel busy in DMO
Flashing ORANGE	Incoming call
No indication	Switched off / Covert Mode

Key, Knob, and Button Overview

Soft Keys

Press  or  to select the option that appears in the screen directly next to the upper or lower soft key. In this example, **Contcs** is displayed next to the key. Pressing  enters the contact list. In the user guide, this action is described as “press **Contcs**”.

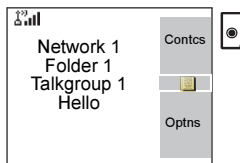

Menu Button

Press **Menu** to enter:

- **The menu (when there is no on-going activity).** The MTM800E menus allow you to control your MTM800E settings. Menus are organised in a hierarchy. See “List of Menu Items” on page 107.. The menu options provide access to a further list of options called a sub-menu.
- The **context sensitive menu** (when  icon is on) to view a list of items for the current menu.

Examples of Menu and Sub-menus:

The example below shows how to setup the Ring Style in the terminal.

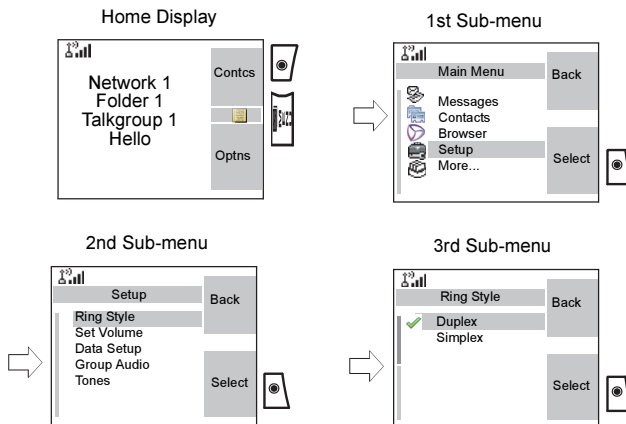

Example of Context Sensitive Menu:

This example shows the screen when editing a name listed in the contact list. From the Home display, press **Contacs**. Scroll to the name you wish to edit. Press **Menu**. The context sensitive menu opens up, allowing you to choose among the entries.

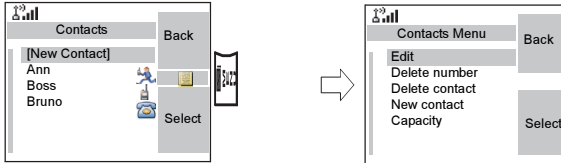

Rotary Knob

The Service Provider can program the Rotary knob to one of the following uses:

1. **Dual Control** – the knob is used as both a Volume control and to scroll through Lists. Press the knob to toggle between Volume and List (default programming).
2. **List Control** – the knob is used to scroll lists or menu items. In this case volume control is always via menu or via external accessories (if present).
3. **Volume Control** – the knob is used only as a volume control; turn clockwise to increase the audio volume level.

Press and hold the Rotary knob to lock it, press and hold it again to unlock. Powering Off also unlocks a locked Rotary knob.

Emergency Button

Press and hold this button to enter Emergency Operation.

When the MTM800E is powered down, press and hold this button to power **On** in Emergency Operation (if configured by your Service Provider).

See “Emergency Operation” on page 69.



Programmable Keys (0-9, *, #, , and)

The MTM800E supports the one-touch feature that allows you to select/activate commonly used features by pressing and holding an assigned key. Your Service Provider should program the keys with the relevant features.

The following table lists the programmable features and their availability in specific MTM800E states/modes. For detailed information on the features, see the relevant section in the user guide.

Feature	Description
Talkgroup Switch	Switches to a specific talkgroup
Previous Talkgroup Switch	Switches to the previous talkgroup (even if the operation mode was different)
Talkgroup Scan	Toggles on/off the Talkgroup Scan function (TMO only)
DMO/TMO	Toggles between DMO and TMO
Status Message	Sends a dedicated status message to a dedicated address
Text Message Template	Sends a predefined/user defined template to a dedicated address
Call Dial (Private, Phone, PABX)	Initiates a call to a predefined entry in the contact list
Transmit Inhibit (TXI)	Toggles between activated and deactivated TXI Mode.
Screen Saver	Activates screen saver.
Backlight Adjustment	Toggles through the backlight intensity profiles.
Covert Mode	Toggles on/off covert mode
Time & Date	Shows time and date.
Hi/Lo Audio	Activates low/high audio
Horn & Lights	Toggles on/off horn and lights.

Feature	Description
Initiate Fallback Alert	Sends Fallback Alert
RUI Log On/Off	Logs on/off the user
Display OPTA	Displays Operative Tactival Address
BSI Encryption	Toggles on/off encryption
Speaker Enable/ Disable Per Call	Toggles on/off the speaker
RMS Mode*	Toggles on/off RMS feature

*) Applicable only for the * and # keys.

NOTE *If programmable one-touch keys are enabled, one-touch dial is disabled (see page 67).*

To use the one-touch feature:

- Press and hold the required key for a few seconds.

Your MTM800E displays the number and act according to the programmed feature.

NOTE *The required time you need to press the assigned keys to activate a one-touch function is set as default to 1 second. This time may be set, however, by your Service Provider.*

NOTE *For information on the function assigned to each assigned key, please refer to your Service Provider.*

One-touch Private Call is set by the Service Provider.

1. If it is set to **Simplex**, then outgoing Private Call is Simplex too.
2. If it is set to **Duplex**, then outgoing Private Call can be duplex in TMO, Simplex in DMO with the last Group Call Originator number.
3. If it is set to **Duplex**, then outgoing Private Call can be duplex in TMO and cannot be initiated in DMO when the phone book index is required.

Function Keys

External Alarm Key

To turn the External Alarm (Horn & Lights Alarm) on or off, press  (default function - if not programmed with another function by your Service Provider).

Use the Horn & Lights Alarm when you leave your car and want to be alerted if an important message arrives (Private Call, for example).

NOTE *In order to operate the Horn & Lights Alarm, you must install the GKN6272 accessory in your vehicle.*

If the External Alarm function is pre-programmed, the car lights turn on and an alarm sounds to inform you of the incoming call.

NOTE *The ignition must be off for the Horn & Lights Alarm to work.*

Speaker Control Key

Press  to activate or deactivate the loudspeaker (default function - if not programmed with another function by your Service Provider).

Backlight Key

If the backlight is set to Manual, there are five profiles of backlight intensity combinations (see Setting the Backlight[®] on page 129.). To change the backlight intensity, press  (default function - if not programmed with another function by your Service Provider).

NOTE *For information on the function assigned to each Function key, please refer to your Service Provider.*

Aliases (Names)

Aliases are optional names that you can assign to stored phone and private numbers (or IDs). To edit an alias, see page 112.

Aliases can be up to 12 characters in length and may consist of letters, numbers, and spaces.

Aliases are displayed during contact list scrolling or during an incoming call. Aliases are also used in alphanumeric search to retrieve numbers from your memory list.

The following screens show examples of how the caller's private number can be displayed.

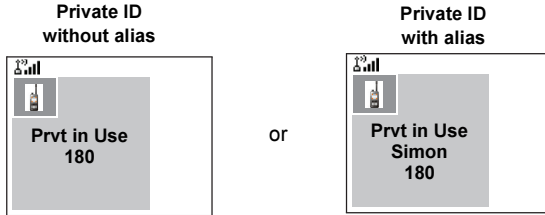

Screen Saver

If your Service Provider configured this feature, the screen saver will automatically cover the MTM800E display after the MTM800E stays idle for a pre-programmed period of time. If you press a key or a call arrives, the screen saver is deactivated and the MTM800E resumes standard operation.

You can also activate this feature manually, by pressing the relevant pre-programmed button (either a side button or numeric key). For example, if manually activated during a group call, the screen saver allows to hide the caller's identity for confidentiality. The screen saver consists of a logo and an alphanumeric text. Check in the menu options whether the Service Provider has given you the capability of entering your own screen saver text (see page 129).

Home Display Text Message

Your MTM800E is provided with a feature that allows your Service Provider to send special text messages to your MTM800E display.

The message is displayed when your MTM800E is idle.

The message will stay on your MTM800E display until a new message is received.

If configured by your Service Provider, your MTM800E will display an internal Home display until another message is received.

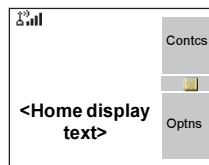

Time & Date

If your Service Provider configured this feature, the MTM800E shows current time and date on home display.

You can also check time and date, wherever in menu, by pressing relevant one-touch button.

Check in the menu options whether the Service Provider has given you the capability of customising time and date settings (see page 126).

Terminal Disable/Enable

Your MTM800E is provided with a feature that allows your Service Provider to disable it temporarily in case it is stolen. When your MTM800E is disabled, no calls can be initiated or received.

While your MTM800E is disabled, it will look and act like it is turned **Off**.

If you try to turn your MTM800E **On**, when it is disabled, it will operate as described above.

If your MTM800E is found, your Service Provider can re-enable it. After your MTM800E is re-enabled, you may resume normal operation.

Terminal Permanent Disable

Your MTM800E is provided with a feature that allows your Service Provider to disable it permanently in case it is stolen or lost. When your MTM800E is disabled permanently, it becomes inoperable.

After a Permanent Disable the MTM800E can not be re-enabled by your Service Provider over the air.

NOTE *Only your Service Provider can disable your MTM800E permanently.*

Selecting TMO or DMO Operation

General

In Trunked Mode Operation (TMO) the MTM800E is used with the infrastructure services within system coverage.

In Direct Mode Operation (DMO) the MTM800E is used without infrastructure services required.

NOTE *While operating in DMO the propagation travels directly from the transmitting terminal antenna to the receiving terminal antenna, with no assistance from any base station or tower. Therefore, the range is critically dependent on the position of the user and the antenna. To achieve best results, hold the terminal in the hand as high as comfortably possible, and be sure not to obstruct the antenna in any way. Be sure that the antenna is clear from the body, cables, or other obstructions. As there is no tower-mounted base station to assist, and the two users are usually standing at ground level, the range is usually shorter than that can be achieved towards a tower or hilltop. Any obstructions (hills, buildings, etc.) between the users will further decrease the range. Conversely, raising the terminal higher or moving to a higher location may improve the range.*

A MTM800E in DMO can communicate with the trunked system (and vice-versa) through a gateway device. To use

that feature, please enable the gateway option in your MTM800E (see Gateway/Repeater Selection" on page 49.).

NOTE *In DMO it is only possible to place Group Calls, Emergency Group Calls and Private Simplex Calls.*

Entering TMO or DMO

Enter TMO or DMO in one of the following ways:

- From the Home display press **Optns** and select **Direct Mode** if the MTM800E is in TMO.
- From the Home display press **Optns** and select **Trunked Mode** if the MTM800E is in DMO.
- Press **Menu** and select **More... > Networks > Trunked Mode** if the MTM800E is in DMO.
- Press **Menu** and select **More... > Networks > Direct Mode** if the MTM800E is in TMO.
- Press the TMO/DMO one-touch button (if programmed by your Service Provider).

NOTE *Your terminal can alert you of an incoming call. Select the alert settings in the Tones menu items.*

TMO Calls

You can make and receive the following types of calls when the MTM800E operates in Trunked Mode:

- Group Calls
- Private Calls
- Phone Calls
- PABX Calls – local (office) extension calls
- Emergency Calls

DMO Calls

You can make and receive Group Calls when the MTM800E operates in Direct Mode (DMO). This includes Emergency Group and Private Calls.

The MTM800E returns to the Home display when there is no activity for a few seconds.

PTT Double Push

This feature, if enabled by your Service Provider, allows you to send the tone when the radio is in idle or Group Call mode by pressing PTT twice.

After the D-PTT tone is played, the user can press and hold the PTT once again to get the permission to talk. Otherwise if the user presses the PTT while the D-PTT tone is played, it is ignored.

After D-PTT tone is sent keeping PTT pressed will result in permission to talk. D-PTT tone is not audible on sending radio.

Individual Call

Talk Group Dialing by Index

You can press Talk Group speed number then  to join the Talk Group. Press **Attach** to confirm.

Non-Emergency calls:

- Pressing **PTT**

If the call type is “Group” or “Private”, then pressing PTT initiates Group or Private Simplex call accordingly. Otherwise special indication is given to the user.

- Pressing **Send** key

If the call type is “PABX” or “Phone” or “Private”, then pressing **Send** initiates PABX or Phone or Duplex private call accordingly. If not allowed a special indication is given to the user.

Incoming Calls During Dialing

The MTM800E remains affiliated to the last Talk Group and receives any group calls. An Incoming call is indicated to the user and the dialing process is interrupted. Non-emergency call does not suspend dialing but the user is able to hear the tone of incoming call. When the terminal receives a private or a phone call, terminal indicates and gives the option to the user to reject or accept it. If the user accepts the call, dialing process ends. When the user rejects it the terminal goes back to the dialing process.

Entering Emergency Mode During Dialing

The dialing process stops if during it the user tries to go to emergency mode

Incoming Long Text Message During Dialing

The Long Text Message is indicated on the display and it interrupts the dialing process.

Changing Call Type

By dialing from the idle screen the user is given the possibility to change the Type of the Call.

Modifying the Type of Call

The infrastructure can modify the type of call you started.

For example, you might start a Simplex Private Call, and the infrastructure could modify the call to a Group Call.

The terminal will alert you of the modification and will display the following messages, depending on the type of call:

- **Call Modified** (to Duplex)
- **Call Modified Use PTT** (modified to Simplex)

Continue the modified call depending on the type of call.

NOTE

- *Simplex Private Call modified from direct setup to hook setup: a ringing tone will alert of the change.*
- *Simplex Private Call modified from hook setup to direct setup: there will be no indication of the change.*

Receiving Calls

Your MTM800E automatically receives the incoming call. Additionally, if Inactivity Revert Mode is enabled, the MTM800E returns automatically to the Home display, after that call ends.

NOTE *Inactivity Revert Mode will occur if configured by your Service Provider.*

Your MTM800E alerts you of an incoming call depending on the setting you selected in the Tones menu option (see page 123).

During message or contact editing, scrolling through the menu and changing any configuration you will be alerted of an incoming Group/Emergency/Broadcast Group Call if configured by your Service Provider.

Pre-emptive Calling

Pre-emptive calling is particularly useful when you need to speak urgently with a user whose terminal is busy in a non-emergency voice call.

A pre-emptive priority call (PPC) is either an Emergency Group Call or a Private PPC (Simplex or Duplex call).

This feature allows to disconnect the on-going lower priority call and to connect to the incoming higher priority call.

To place a PPC, see the Emergency Operation and Private Call sections in the user guide.

Your MTM800E receives the call via speaker or Telephone Style Handset earpiece, according to the setting used when the PPC is received.

NOTE *For call alert, see settings in the Tones menu option (page 123).*

Receiving a PPC is explained in the following paragraphs.

In the screens, **<Any> in Use** refers to any of the non-emergency voice calls: Group, Private, Phone, or PABX.

Receiving an Emergency Group Call during a Call

The MTM800E receives the Emergency Group Call, drops the on-going non-emergency voice call, and connects to the Emergency Group Call.

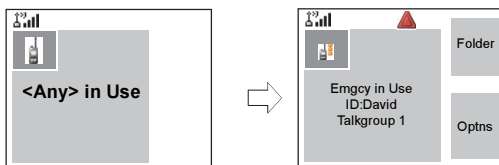

Receiving a Private PPC during a Call

If configured by your Service Provider, the MTM800E receives the PPC, drops the on-going, non-emergency, lower priority voice call, and connects to the higher priority Private Call.

A PPC with lower or equal priority, will be dropped without any indication to the called user and will enter the missed call list.

A PPC Call with Emergency Call priority will be displayed on the screen as "**Emergency**" (instead of "Priority").

Simplex Private PPC Received

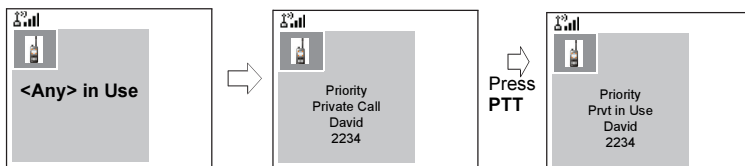

Full-duplex Private PPC Received

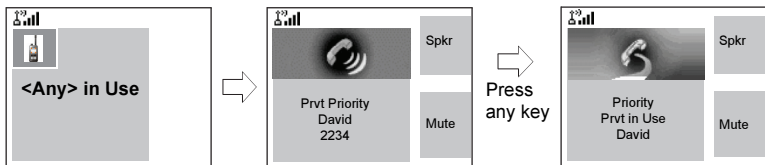

Broadcast Call

The Broadcast Group Call (also called Site Wide Call) is a high-priority group call from the console operator (or dispatcher) to all users located at one or more sites. The terminals are configured to monitor a Broadcast Call, but the users cannot talk back.

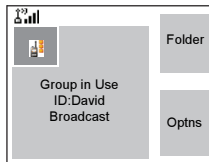

The call can be received as normal Broadcast Call or Emergency Broadcast Call.

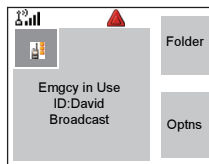

The Broadcast Call pre-empts an on-going Group Call that has the same (or lower) call priority.

For selecting a talkgroup during a broadcast call, see "Selecting a Group" on page 36.. For changing folder during a broadcast call, see "Selecting a Folder" on page 39..

Ambience Listening (AL)

This feature, if enabled by your Service Provider, allows a console operator (or dispatcher) to establish a special call with a specific terminal to monitor voice activity in the local vicinity. The call is setup without any indication to the affected terminal, and any lower priority ongoing voice call or packet data transfer may be pre-empted.

After accepting the call, the terminal transmits in a Simplex Private Call without any action from or indication to the user. The Ambience Listening call is automatically ended when the user initiates any voice call and uses the terminal normally.

Canceling a Call

Choose one of the following, as relevant:

- Press . If you wish to make a new call, start it at once.
- Wait to answer the call. After a time-out set by your Service Provider, the call number will be forwarded to the missed call list.
- Press **Reject** soft key (displayed in an incoming Duplex call). The call number will be forwarded to the missed call list.

Using In-call Features

Loudspeaker

The loudspeaker feature allows you to hold impromptu meetings in Phone, PABX, and Duplex Private Calls.

1. To activate loudspeaker, press **Spkr**. The display shows **Speaker On**.
2. To de-activate loudspeaker, press **Erpce**. The display shows **Speaker Off**.

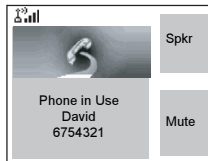

Muting/Unmuting the Microphone

During a Phone, PABX, or Duplex Private Call, use the mute feature to:

- hold conversation without being heard by the caller
 - silence possible background noise in your area
1. Press **Mute**. The display shows **Mute is On**. The microphone is muted. You can hear the incoming audio, but the caller cannot hear any speech coming from your MTM800E.
 2. To speak, press **Unmute**. The display shows **Mute is Off**. The microphone is on.

Covert Mode

If configured by your Service Provider the Covert Mode gives to you the ability completely shut down all visible and audible MTM800E alerts and notifications. This feature makes the MTM800E effectively unnoticeable even in a silent and dark environment.

To Enter the Covert Mode:

- Press the Cover Mode one-touch button (if programmed by your Service Provider).
- Select Covert Mode in the Security menu (refer to Covert Mode” on page 119.).

Local Area Service

This mode, also called Fallback Mode, allows more than one terminal from the same site to communicate when the link between the site and network central controller fails.

Entering and exiting Local Area Service (that is, returning to System Wide Services) is done automatically.

NOTE

This mode can be disabled by your Service Provider.

Entering Local Area Service

When the MTM800E receives a Local Area Service indication from the system, the following occurs:

- The MTM800E sounds a tone.
- The display shows the “Local Area Service” message.
- Display icons and soft keys turn green.
- Any call in progress is dropped upon entering Local Area Service mode.

If configured by your Service Provider, this message/alert is periodically repeated to remind you that the MTM800E is still operating in Local Area Service mode.

The following features are available while the MTM800E is in Local Area Service:

- Registration
- Attachment
- Group Call
- Emergency Call
- Emergency Alarm

Exiting Local Area Service

When the link with the central network controller is re-established, the MTM800E exits Local Area Service and the following occurs:

- The MTM800E sounds a tone
- Any call in progress during Local Area Service is dropped.

Packet Data

The Packet Data (PD) Service allows you to transfer data in a TETRA system using the Internet Protocol (IP). Check with your Service Provider for the availability of this feature.

NOTE

For transferring data from a standard computer over the air connect the computer via the Active Data Cable GMKN1022 with your MTM800E. Your Service Provider has to setup additional applications on your computer.

If set up by your Service Provider it is possible to accelerate the transmission by using the Multi-Slot Packet Data (MSPD) Service (refer to Packet Data” on page 148.).

Dual Control Head

The Dual Control Head feature allows you to have two Control Heads: Master and Slave, which have the same functionalities, except the WAP service and the Remote Programming. Both displays contain the same information. All of the radio functionality is available only when the Master is on.

NOTE *If this feature is enabled by your Service Provider, one of the icons is displayed all the time.*

Check with your Service Provider default accessory selections and the radio behaviour for all types of calls as each Control Head can have different setup.

Master Single Control Head Mode



This mode occurs when the connection between the Master and Slave was not established upon power up and when Slave was switched off. Icon  is displayed.

Slave Standalone Mode

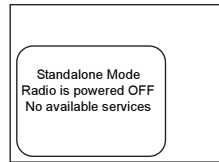

It is related to Slave Control Head when the Master Control Head is turned off. In this mode no radio functionality is available, except  button to turn it off.



Dual Control Head Link

If the Dual Control Head Link is established between Master and Slave Control Head, the icon  is displayed and the full functionality is available on both. Otherwise when the link is broken or lost, icon  is displayed and only the Master Control Head has a full functionality.

Keys Interactions

If any key except Emergency button and  is pressed on any Control Head, the icon  is displayed and all the keys are blocked on the other Control Head.

NOTE *Service Provider can adjust the time that the keypad is blocked on the other Control Head.*

NOTE *At any time Emergency button and  can be pressed on both Control Heads.*

Initiating and ending WAP session can be done from both Control Heads. However ongoing WAP session is only available on Master. In such case a notification is displayed on Slave.

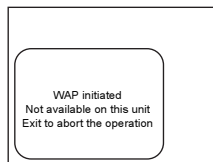

Voice

During any call, voice can be heard in both Master and Slave speakers simultaneously.

Only one MIC/PTT can be opened at a time. The one that is pressed as first is allowed to initiate the transmission.

TMO Group Call

General

A Group Call is an instant communication between you and others in a talkgroup that you select. Participants may join (late entry) and leave an on-going Group Call. A talkgroup is a pre-defined set of subscribers enabled to participate in and/or invoke a Group Call, that is set up by your Service Provider.

Talkgroups appear on your display as names or numbers (for example: Sales, Service, Electricians, Talkgrp10).

Talkgroups can be divided into **many folders**. Each folder may contain several talkgroups.

For ease of use, your MTM800E also provides the ability to:

- Perform an alphabetical search of the talkgroup aliases. Scroll through the entire talkgroup list.
- Organise your groups into three folders (default name for the first favorite folder is called My Groups which is set up by your Service Provider).

Your talkgroups may be organized into **scan lists** (set up by your Service Provider, or by yourself through the Menu).

When you activate one of these scan lists, your MTM800E will continuously monitor the activities of the selected talkgroups.

By assigning priorities to the talkgroups defined in the **scan list**, you will be capable of accepting calls that have higher priority than the on-going call.

You can go to talkgroup, folder, or scanning selection when the terminal is idle.

Pressing **PTT** during talkgroup selection switches to a new group and starts a call.

Each talkgroup may have one associated **Announcement Talkgroup** (ATG) that it monitors (if set up by your Service Provider).

An ATG is a special group which is linked to a number of talkgroups and has the highest priority level, thus enabling broadcast of the call to all these talkgroups.

When an ATG is selected, the scanning icon is not displayed. The MTM800E monitors the ATG scan list instead of the selected scan list. The ATG scan list contains all the talkgroups associated with a selected ATG. Your Service Provider should advise what talkgroups are associated with which Announcement Talkgroup.

Your MTM800E will always monitor the Group Calls in the ATG scan list. To place an Announcement Call, you must first select the specified Announcement Talkgroup as advised by your Service Provider, otherwise you will only be able to participate when an Announcement Talkgroup is received.

Activation and deactivation of talkgroup scanning has no effect on the ATG scan list.

Selecting a Group

You can select a talkgroup in one of the following ways, by using the:

- rotary knob
- navigation key
- alphabetical search
- folder search
- numeric keypad entry - Speed Dialing (if configured by your Service Provider)

For group scrolling configuration, see page 40.

NOTE

When you navigate in the favorite folders and select a DMO group, your terminal will switch between TMO and DMO (and vice-versa).

Using the Rotary Knob

(If configured by your Service Provider)

From the Home display, press shortly on the Rotary knob and rotate until the requested group appears.

Group selection occurs:

- After a time-out
- By pressing **Select** (if configured by your Service Provider)
- By pressing **PTT**

Using the Navigation Key

From the Home display, scroll left or right until the requested group appears. Then press **Select** to confirm selection.

Pressing the **PTT** will also choose the group automatically and start transmission.

Using Alphabetic Search

From the Home display, press **Optns**. Select a group by abc search (“**TG by abc**”). You can type up to 12 characters that are shown at the bottom of the screen while you are typing. It will highlight the closest talkgroup name. Press **Select** to enter the group.

Using Folder Search

From the Home display, press **Optns**. Select a group by folder search (“**TG by Folder**”). Select the folder name and select the group.

NOTE

For alphabetic and folder search there are no duplication names listed. If the user selects the group that is located in more than one folder, the radio chooses the one that is prioritized by:

- 1. current folder*
- 2. parent folder to the current folder*
- 3. default talkgroup folder which is defined by the Service Provider.*

Using the Numeric Keypad - Speed Dial

From the Home display, you can dial a group by entering its speed number via the keypad. This feature is called Talkgroup Speed Dialing. The speed number is pre-configured in the terminal. You can view a speed number attributed to a group, if it exists.

Viewing the speed number

1. From the Home display, press **Optns**.
2. Select:
 - **TG by Folder** then select the folder and highlight an appropriate talkgroup
 - **TG by abc** and then highlight an appropriate folder name
3. Press **Menu**.
4. Select **View** to view the talkgroup speed number.

In this example “82” is the speed number. Press **Back** to return to the attached group screen.

Dialing a speed number

1. Enter a number (for example: “82”).
2. Press .
3. Press Attach to attach the new group, or press PTT to attach and call.

Selecting a Group using Navigation Keys / Alphabetic Search / Folder Search

You can select a group folder without an interruption on receiving and during a call.

Selecting a group on receiving a call

If you select a group and a call is incoming, MTM800E display remains unchanged while you hear the call.

During the selection you cannot see calling party information. Press **Cancel** when using Navigation Keys and **Back** when using Alphabetic/Folder Search, and then calling party information display appears, if you are still in the call.

NOTE *When an Emergency Call is received, then dialing is aborted and Emgcy In Use display appears.*

Selecting a group during a call

If you start selecting a group during a call, **Group In Use** or **Emgcy In Use** display disappears.

During the selection you cannot see calling party information. Press **Cancel** when using Navigation Keys and **Back** when using Alphabetic/Folder Search, and then calling party information display appears again, if you are still in the call.

Selecting a Folder

From the Home display, press **Optns**. Select **Folder**, and select the desired folder. The display shows the last selected group in that folder.

“My Groups” Folders

You can organise your favorite groups into three folders.

Selecting My Groups

From the Home display, press  to quickly access the folder.

Adding/Deleting Groups

For more information, see “My Groups (TMO/DMO)” on page 135.

Group Scrolling Configuration

Your Service Provider can configure scrolling via rotary knob or navigation key as follows:

- **Scroll to next folder** — when the folder end is reached during group scrolling, further scrolling switches to the group list in the next folder.

For example: Folder 1 has Group11 and Group12. Folder 2 has Group21 and Group22. Group11, Group12, Group21, Group22 will appear during scrolling.

OR

- **Stay in folder** — when the folder end is reached during group scrolling, further scrolling restarts the folder group list. To move to the next Folder, you should select it.
For example: Folder 1 has Group11 and Group12. Folder 2 has Group21 and Group22. Select Folder 1: Group11, Group12, Group11, Group12 will appear during scrolling. Change to Folder 2: Group 21, Group 22, Group 21, and Group 22 will appear during scrolling.

In addition, your Service Provider might configure the rotary knob as follows:

- **End-Stop Rotary Knob Scrolling** — the rotary knob will stop when it reaches the last group in the folder, and a tone will alert you that you have reached the last group in the folder. Use the navigation key to continue scrolling through the list.

Activating/Deactivating Scanning

See “Setting Group Scanning” on page 131.

Making a Group Call

1. Select required talkgroup and from the Home display press and hold the **PTT**.
2. Wait for the talk permit tone (if configured) and then speak into the microphone. Release the **PTT** button to listen.

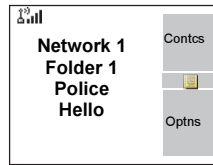

When you start a call, all members of the selected group who have their units turned on, will receive the Group Call

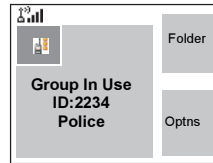

NOTE

The “No Group” message is displayed when you are out of the normal coverage area of your selected group. You must then select a new group that is valid for your working location.

NOTE

If you are in an on-going Group Call and wish to make a new call, press  to ignore the current call. Start the new call.

Receiving a Group Call

General

Unless it is engaged in a call, your MTM800E will receive the Group Call. To talk back, press and hold **PTT**.

Your MTM800E shows the Group name and the caller's private number or name if previously stored in your contact list.

The following screens show examples of how the caller's private number (ID 124) is displayed.

Private ID without alias

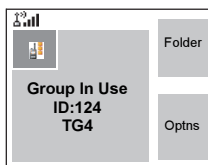

OR

Private ID with alias

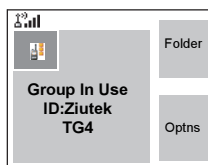

NOTE

For incoming call alert, see settings in the Tones menu option (page 123).

NOTE

When receiving a Group call, you will hear a “New Group Call” tone (if configured by your Service Provider).

Receiving a Group Call in Idle Screen with Scan Off

You can receive a group call from the selected talkgroup or from the associated ATG only.

Your MTM800E will receive the Group Call.

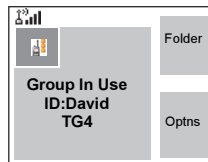

Receiving a Group Call in Idle Screen with Scan On

With Scan On, you can receive a group call from the scan list you set up, in addition to receiving a group call from the selected talkgroup or from the associated ATG.

Receiving the scan call functions as receiving an associated ATG or selected call in scan off is possible, except for the following:

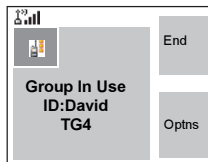

- The terminal sounds a tone as explained in the note below.

NOTE

- *When receiving a High Priority Group Call, you will hear a “High Priority Group Call” tone (if configured by your Service Provider).*
- *When receiving a Group Call from your scan list, which is not from a high priority group, you will hear a “New Group Call” tone (if configured by your Service Provider).*
- To block reception of a Group Call, select **Optns** then **Block**. Powering off/on the terminal unblocks the reception of this Group Call.

Receiving a Group Call during an On-going Group Call

Depending on how the Service Provider has configured incoming calls, the incoming call will either be:

- Forced upon you and will interrupt the on-going call (if the incoming call has higher priority than the on-going call).
OR

- Presented to you (if it has higher priority than the on-going call).
 - To accept the call, press **Join**.
 - To cancel the call, press **End**.

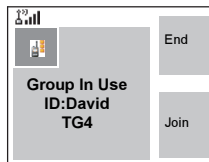

Receiving an Emergency Group Call

For detailed information, see page 28.

Receiving a Broadcast Call

For detailed information, see page 29.

Transmit Inhibit

You can activate the Transmit Inhibit (TXI) Mode before entering RF sensitive areas, e.g. in hospitals or in potentially explosive areas, where safety can be jeopardized due to MTM800E transmission radiation.

NOTE *Radiation of the MTM800E is only suppressed if the TXI Mode is activated or the MTM800E is separated from power supply.*

In TXI Mode the MTM800E will not transmit under any circumstances, except for the Emergency Call, which can be initiated even if the MTM800E is in TXI Mode.

All MTM800E functions and keys which cause transmission, e.g. registration to the network, change of talkgroup or folder, sending messages, pressing **PTT**, etc. are disabled. In this case the display shows “Not Allowed In TXI Mode” and the MTM800E sounds the “Transmit Inhibit” tone.

When no danger to safety exists anymore (for instance if you leave the RF sensitive area), the TXI Mode can be deactivated and the MTM800E returns to standard operation.

Setting the TXI Mode is described in “Setting Transmit Inhibit (TXI) Mode” on page 147.

Activated Transmit Inhibit is indicated by the solid orange LED and flashing between the two displays:

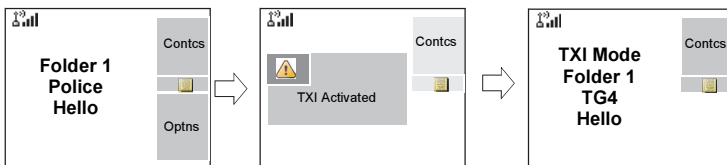

Dynamic Group Number Assignment (DGNA)

DGNA provides the ability for a network operator or authorised user to dynamically allocate new, or update existing talkgroups to selected terminals over the air interface.

Using supplementary services messages (SS-DGNA), the network operator can command your terminal to add talkgroups or to update the existing talkgroups, or to delete talkgroups from the list. This operation is performed by transmitting the data into your MTM800E.

NOTE *Your Service Provider can gather some Talkgroups under one Super-group and transmit it to your MTM800E as a DGNA. In such a case, you will be able to participate in calls to/from all the groups in the Super-group.*

DGNA Reception with Notification Message

When a DGNA message is received and DGNA notification was configured by your Service Provider, you will get a tone indication and notification message (“**Talkgroup list updating**”), and then a display of the new assignments.

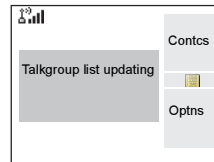

You can use the **View**, **Attach**, **Back** soft keys, **Menu**, , and Emergency button.

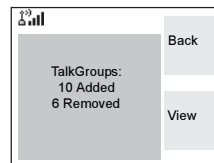

Pressing one of them exits the DGNA display.

1. To view the added/deleted talkgroups details press **View**. You may scroll through the list.
2. To return to the previous display press **Back**.
3. To select the DGNA group, press **Attach**. Or scroll to another group and press **Attach**.

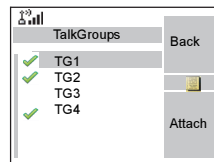

NOTE

- Group attachment is not allowed in TXI Mode.
- Once you exit the DGNA notification screen, select one of the newly added groups as explained on see page 36.

If the DGNA message is received to delete all Talkgroups, your MTM800E will display the following:

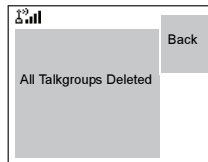

DGNA Reception without Notification Message

If DGNA notification was not configured by your Service Provider, you will get a tone indication and notification message only and only if a selected group was changed by the DGNA.

DGNA Auto Select Group

If DGNA Auto Select was configured by your Service Provider, whenever a DGNA message is received by your terminal, the talkgroup will automatically be made the selected group by your terminal.

Button/Footswitch

This feature provides to the user ability to send preset status message by pressing the button/footswitch. In TMO mode, the ability to send an Alarm and initiate a TMO Group/Private call is unavailable.

Message addressing and sending:

- the address can be predefined by the Service Provider, if not it is sent to currently selected group
- if no group is selected the message is sent to the reserved address
- message is sent even if the user is involved in any active call.

The indication depends on the setting from the Service Provider. Visible/audible indications can be disabled for the status message.

When the radio is PIN locked the user can still press the Button/Footswitch to send the message.

If the radio is out of service the user will only see indication that the operation failed.

DMO Group Call

General

In DMO, the MTM800E can be used without your Service Provider's infrastructure.

Direct Mode allows communication with other terminals also operating in Direct Mode, which are on the same frequency and talkgroup as your MTM800E.

NOTE *In DMO it is only possible to place Group Calls, Emergency Group Calls and Private Simplex Calls.*

You can receive a call:

- From the selected talkgroup
- From other users within talkback range (if configured by your Service Provider). This is called an InterMNI (Mobile Network identity) call.
- From an open group. (An open group is a super-group to which all DMO groups belong.)

When you start a call, the members of the selected talkgroup who have their units turned on, and are within the group subscriber identity (as configured by the Service Provider), will receive the transmission.

In DMO the MTM800E can communicate with the trunking system (and vice-versa) if the **Gateway** option is enabled in the MTM800E.

To enhance the terminal's DMO coverage area the DMO group can link to a repeater if the **Repeater** option is enabled in the terminal. Additionally the **GW + Rep** (gateway and repeater) communication mode can be used.

If Transmit Inhibit is activated while the terminal is set to DMO, the PTT is disabled. You can only listen. For detailed information on Transmit Inhibit, see page 44. DMO Talkgroup selection is allowed when Transmit Inhibit is activated.

Favorite Folders

You can organise your favorite groups into three folders.

Selecting the My Groups Folder

From the Home display, press  to quickly access the folder.

NOTE *Default name for the first favorite folder is “My Groups”.*

Adding/Deleting Groups from Favorite Folders

For more information, see “My Groups (TMO/DMO)” on page 135.

Adding/Deleting/Renaming Favorite Folders

For more information, see “My Groups (TMO/DMO)” on page 135.

Selecting a Group

See “Selecting a Group” on page 36.

Selecting a Group using Navigation Keys / Alphabetic Search / Folder Search

See “Selecting a Group using Navigation Keys / Alphabetic Search / Folder Search” on page 38.

Selecting a Folder

See “Selecting a Folder” on page 39.

Group Scrolling Configuration

See “Group Scrolling Configuration” on page 40.

Gateway/Repeater Selection

Use the DMO **Config** sub-menu for setting the Gateway and Repeater options.

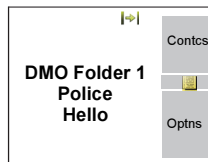

1. Press **Optns** to enter the options menu in DMO.

DMO Options sub-menu

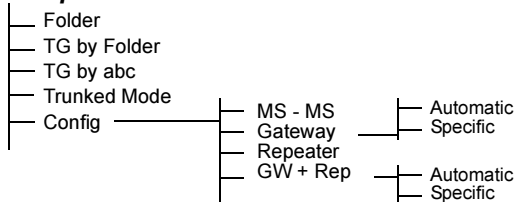

2. Scroll to **Config**, and press **Select**.

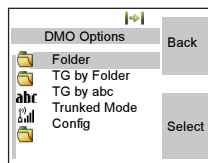

Selecting DMO Group Call MS to MS

To change from gateway or repeater mode to MS - MS mode (DMO terminal to terminal call):

1. Press **Optns**, scroll to **Config** and press **Select**.
2. Scroll to **MS - MS** and press **Select**.
The following message to be displayed for a few seconds: **MS - MS Will Be Used**.

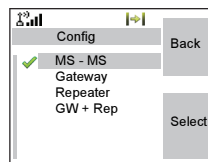

Selecting DMO Group Call via Gateway

While in DMO, proceed as follows to choose a gateway to set up a call via Gateway for the selected talkgroup:

1. Press **Optns**, scroll to **Config** and press **Select**.
2. Scroll to **Gateway** and press **Select**.
3. The display shows the last gateway selection method. Use the navigation key to scroll to your selection and press **Ok**:

Automatic – the MTM800E will use the first available gateway for that talkgroup. The Gateway icon will flash upon selecting that option.

Specific – the MTM800E will use only the gateway with the specified Gateway address for that talkgroup.

Upon selecting “Specific”, you will see one of the following displays:

- The selected gateway address (e.g.: 1022), pre-programmed by your Service Provider or previously entered by yourself via the keypad. Press **Edit** and then **Ok** to use the current address, or enter a new address via the keypad, and press **Ok**. The Gateway icon will flash upon selecting the gateway.

- “None”, indicating that no gateway was selected for that talkgroup. Press **Edit** and enter an address via the keypad, Press **Ok**. The Gateway icon will flash upon selecting the gateway.

When the MTM800E detects the suitable gateway, the Gateway icon will turn solid.

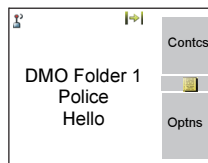
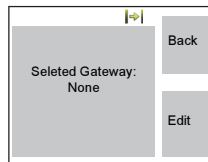
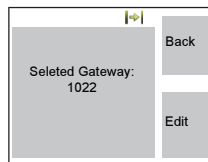
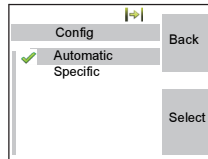

Selecting DMO Group Call via Repeater

While in DMO, proceed as follows to choose the Repeater option to set up a call via Repeater for the selected talkgroup:

1. Press **Optns**, use the navigation keys to scroll to **Config** and press **Select**.
2. Scroll to **Repeater** and press **Select**.
3. The MTM800E will use the first available repeater for that talkgroup. The repeater icon will flash upon selecting that option.

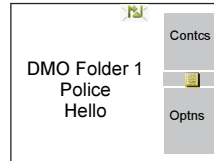

When the MTM800E detects the proper repeater presence signal, the Repeater icon will turn solid.

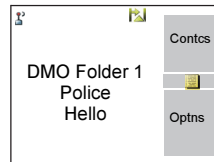

Selecting DMO Group Call via Gateway and Repeater

While in DMO, proceed as follows to choose the Gateway and Repeater option to set up a call via Gateway or Repeater (Gateway preferred) for the selected talkgroup.

1. Press **Optns**, scroll to **Config** and press **Select**.
2. Scroll to **GW + Rep** and press **Select**.
3. The display shows the last "GW + Rep." type selection. Use the navigation key to scroll to your selection and press **Select**:

Automatic – the MTM800E will use the first available gateway for that talkgroup. The Gateway icon and the Repeater icon will flash upon selecting that option.

Specific – the MTM800E will use only the Gateway with the specified Gateway address for that talkgroup.

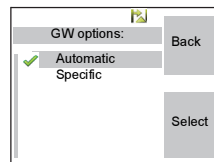

Upon selecting “Specific”, you will see one of the following displays:

- The selected gateway address (e.g.: 1022), pre-programmed by your Service Provider or previously entered by yourself via the keypad. Press **Edit** and then **Ok** to use the current address, or press **Edit** and enter a new address via the keypad, and press **Ok**. The Gateway and Repeater icons will flash upon selecting the gateway.
- “None”, indicating that no gateway was selected for that talkgroup. Enter an address via the keypad, and press **Ok**. The Gateway and Repeater icons will flash upon selecting the gateway.

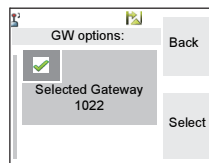

When the MTM800E detects the appropriate gateway and/or the repeater, the Gateway and/or Repeater icons will turn solid, respectively.

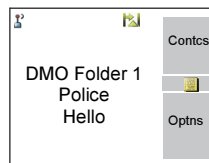

Making a DMO Group Call (MS to MS)

1. Enter **Direct Mode** by pressing **Optns** and selecting **Direct Mode**.
2. Make sure that you have selected the required group. Press and hold the **PTT** button.
3. Wait for the talk permit tone and then speak into the microphone. Release the **PTT** button to listen.

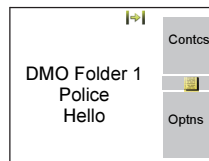

Making a DMO Group Call via Gateway

1. While in DMO, choose a gateway as described in “Selecting DMO Group Call via Gateway” on page 50.
2. Place the call for the selected talkgroup:
 - If you press **PTT** while the gateway is not available, you will start a DMO call without gateway. The Gateway icon will disappear.
 - If you press **PTT** while the selected gateway is available, but the call is rejected by the gateway, your MTM800E will sound a tone and display the following screen, informing you that the call will be setup without gateway. The Gateway icon will disappear.
 - If you press **PTT** while the gateway is available, you will start a DMO call with gateway. The Gateway icon will be solid.

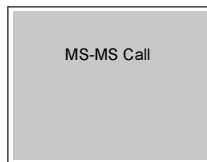

Making a DMO Group Call via Repeater

1. While in DMO, choose the Repeater option as described in “Selecting DMO Group Call via Repeater” on page 51.
2. Place the call for the selected talkgroup:
 - If you press **PTT** while the repeater is not available, you will start a DMO call without repeater. The Repeater icon will disappear.
 - If you press **PTT** while the selected repeater is available, but the call is rejected by the repeater your MTM800E will sound a tone and display the following screen, informing you that the call will be setup without repeater. The Repeater icon will disappear.
 - If you press **PTT** while the repeater is available, you will start a DMO call with repeater. The Repeater icon will be solid.

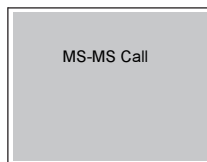

Making a DMO Group Call via Gateway and Repeater

1. While in DMO, choose the Gateway and Repeater option as described in “Selecting DMO Group Call via Gateway and Repeater” on page 51.
2. Place the call for the selected talkgroup:
 - If you press **PTT** while both gateway and repeater are *not available*, you will start a DMO call without gateway and repeater. The Gateway and Repeater icons will disappear.
 - If you press **PTT** while both gateway and repeater are *available*, but the call is rejected by the gateway, a repeater call will be attempted.
 - > If it is *successful* your MTM800E will display the message **Repeater Call** and a call via repeater will proceed. The Gateway icon will disappear.
 - > If it is *not successful* your MTM800E will display the message **MS-MS Call** and a terminal to terminal call will proceed. The Gateway and Repeater icons will disappear.
 - If you press **PTT** while both gateway and repeater are *available*, a gateway call will be attempted.
 - > If it is *successful* your MTM800E will start a DMO call with gateway. The Gateway icon will be solid. The Repeater icon will disappear.
 - > If synchronising with a gateway is *not successful* a repeater call will be attempted.
 - > If it is *successful* your MTM800E will display the message **Repeater Call** and a repeater call will proceed. The Gateway icon will disappear and the Repeater icons will be solid.
 - > If it is *not successful* your MTM800E will display the message **MS-MS Call** and a terminal to terminal call will proceed. The Gateway and Repeater icons will disappear.

NOTE

If Gateway and Repeater mode is selected, and if one of the devices is not available, the call setup is proceeding as if this device was not selected.

Example: In case of the Gateway is available and the Repeater is not available, after an unsuccessful Gateway call attempt the call falls back to MS - MS mode immediately with the **MS-MS Call** message.

Receiving a DMO Group Call

You can receive a DMO Group Call only when your MTM800E is in DMO.

Your MTM800E will display the caller's private number or alias, and the talkgroup name.

The following screens show examples of how the caller's identity can be displayed.

NOTE

For call alert, see settings in the Tones menu option (page 123).

Receiving a DMO Group Call (MS - MS)

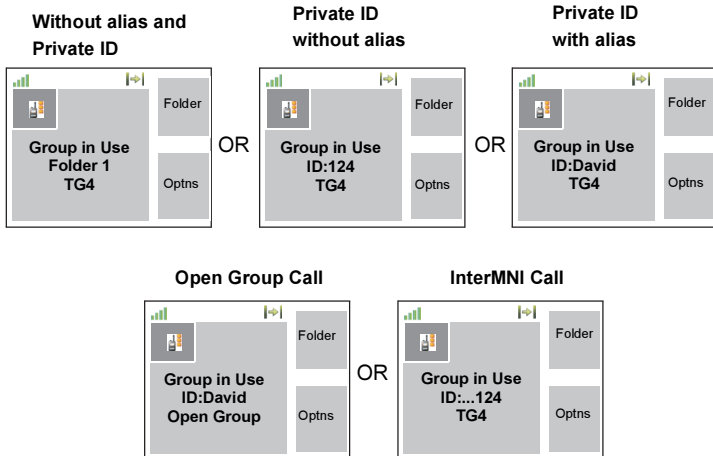

When an InterMNI call is received, you can press Network to see the Network alias and/or number.

Receiving a Group Call (via Gateway / Repeater)

Without alias and
Private ID
(e.g. via gateway)

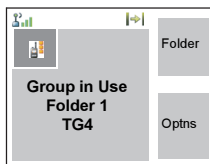

Private ID
without alias
(e.g. via gateway)

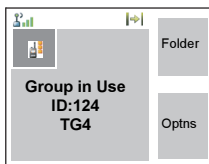

Private ID
with alias
(e.g. via repeater)

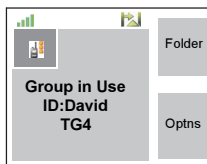

The display shows the ID of the TMO caller.

The Gateway plus DMO or the Repeater icons are displayed accordingly to the ongoing call type (Gateway or Repeater).

NOTE

- If MS to MS mode is selected, and the terminal receives a call via repeater, the Repeater icon will be shown (if the repeater mode is enabled by the Service Provider, otherwise the call will not be accepted).
- If Gateway mode is selected but a gateway is not available, The Gateway icon will be solid in case of an incoming gateway call.

DMO Private Call

If configured by your Service Provider it is possible to make and receive a Private Call in DMO.

However the Gateway and/or Repeater options are activated they are not used for a DMO Private Call. The DMO Private Call will be a direct communication between two TETRA terminals (MS - MS).

For detailed information, see “Private Call in DMO” on page 62.

Emergency Group Call

For detailed information, see “Emergency in DMO” on page 78.

Exiting DMO

To exit DMO, press **Optns** and select **Trunked Mode**. For other ways, see “Selecting TMO or DMO Operation” on page 23.

Private Call

General

A Private Call, also called Point-to-Point or individual call, is a call between two individuals. No other terminal can hear the conversation.

This call can be a

- *Duplex* call (if the system allows) in **TMO**, or
- *Simplex* call in **TMO** or **DMO**.

In a Duplex call, both participants can speak at the same time, while in a Simplex call, only one person can speak at a time.

NOTE *If your Service Provider has restricted access to the Contacts list, it might not be possible to create a new contact, edit existing contacts or dial up a number which is not in the Contacts list.*

For operating the MTM800E in RF sensitive areas, see “Transmit Inhibit” on page 44.

NOTE *While Transmit Inhibit is activated, an incoming Private Call is indicated, but it is not possible to answer the call.*

Making a Private Call in TMO

NOTE *If you are in an on-going Group Call and wish to make a new call, press  to ignore the current call. Dial the number.*

1. From the Home display dial a number.
2. If Private is not the first type of call presented, press **CType** to select the Private Call type.

3. For a *Simplex* call, press and release the **PTT** button. You will hear a ringing tone. Wait for the called person to answer your call. (This is also called a hook setup.) *OR,*

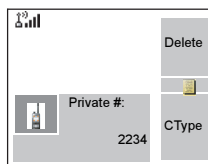

Press and hold **PTT**. Wait for the talk permit tone (if configured) before talking, and release the **PTT** when listening. (This is also called a direct setup.)

NOTE *The user can make the MS-ISDN Simplex call by pressing the PTT, when this feature is enabled by the Service Provider.*

For a **Duplex** call, press and release . You will hear a ringing tone. Wait for the called person to answer your call.



4. To end the call, press .

If the called person or the infrastructure end the call, the **Call Ended** message is displayed.



NOTE *While Transmit Inhibit is activated, an incoming Private Call is indicated, but you cannot answer the call.*

Other Ways of Dialing

Dialing via Contact List

You can also use the contact list to select a number you previously stored. Press **Contacs** and search the stored number by scrolling ( or ) or by entering up to 12 characters of the contact name.

NOTE *If no name is stored under a letter, the MTM800E automatically searches forward, alphabetically, until the next name is found. If more than one name in the list begins with the same letter, you can scroll to view other names or type up to 12 letters.*

If the contact has more than one number stored, pickers surround the contact icon. Use  /  to select the number.

Short Number Dial

If set up by your Service Provider, Short Dial allows you to dial part of the full number of the person you wish to call. Your MTM800E will automatically complete the number and send it over the air based on your own MTM800E's identity. For example:

1. Dial 456 (instead of 4282456, the full number).
2. To place the call, press the **PTT** or .

3. To hang up, press .

Dialing Scheme

Private ID is a number with up to 16 digits.

16-14	13-9	8-1
MCC	MNC	ISSI

Two options are given to the user:

- Fixed - user may provide up to 16 digits which include the MCC, MNC and ISSI numbers or if less than 16 digits are entered, it will be filled with the digits that are set by the service provider.
- Automatic - you need to provide up to 8 digits (if more it will switch to fixed mode). If you will provide less than 8 digits, radio fills the number with its own ISSI. The rest of the 16 digit number is automatically given by the radio.

If you select more than 16 digits the display will give you a warning about incorrect input.

Recent Calls List

Select the number from the recent call list. See “Recent Calls” on page 138.



One-touch Dial

See “Programming Keys” on page 18.

Calling a Number in a Message

See “Calling a Number in a Message” on page 157.

Receiving a Private Call in TMO

1. The MTM800E switches to the incoming Private Call. The display shows the caller's identity.
2. To answer an incoming *Simplex* call, press **PTT**. To answer an incoming *Duplex* call (indicated by **Spkr/Erpc** soft keys), press .
3. To end the call, press .

NOTE *Your terminal can alert you of an incoming call. Select the alert settings in the Tones menu items*

Private Call in DMO

If configured by your Service Provider it is possible to make and receive a Private Call in DMO. You can make or receive a DMO Private Call only when your MTM800E is in DMO.

NOTE *Private Calls via DMO Repeater and/or DMO Gateway are not supported.*

The calling and called party needs to be on the same talkgroup.

Making a Private Call in DMO

1. From the Home display enter a number.

Dialing via

- Contact List or
- Recent Calls Lists

works like described in “Other Ways of Dialing” on page 60.

2. Press and hold **PTT**. Wait for the talk permit tone (if configured) before talking, and release the **PTT** when listening.

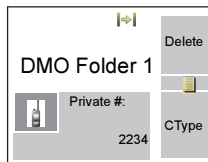

3. The call ends after a pre-programmed time, or if you press .

NOTE *There is no presence check for Private Calls in DMO. This means you don't know whether the called party is available when you starts the call.*

Receiving a DMO Private Call

When a DMO Private Call is received, the call is started immediately without need to accept it by the called party.

1. Press **PTT** to talk back and start talking.
2. The call ends after a pre-programmed time, or if you press .



NOTE *If the called party presses  the DMO private call is suspended for a specified time and in case the calling party is still transmitting the call is joined again.*

Dialing on Receiving a Call

Dialing process is not changed for the Group Call. Otherwise display is changed accordingly to the incoming call type and after the call display returns to where the dialing process was left.

NOTE *When an Emergency Call is received, then dialing is aborted and Emgcy In Use display appears.*

Making a Private PPC (Pre-emptive Priority Call)

NOTE *This feature is only available if set up by your Service Provider.*

1. Enter the private number and press **PTT** or .
2. If the display shows the called user is busy, press **Yes** to interrupt the on-going call.
3. You will hear a ringing tone. Wait for the called person to answer your call.
4. Continue the call as in a regular Simplex or Duplex Private Call.

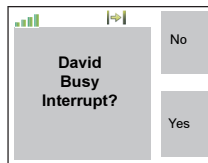

Call Queuing

When there are no available infrastructure resources for a call while in a setup phase, or while in an active call during cell re-selection, the call will be queued. The MTM800E will remain in queue for a pre-programmed period of time. If the resources become available, the call will proceed. If there are no resources after a certain period of time, the MTM800E will end the call.

Phone and PABX Calls

General

The **Phone Call** allows you to call a landline telephone number or a cellular mobile phone number. The **Private Automatic Branch Exchange (PABX) Call** allows you to call local (office) extension numbers. This type of call needs to be activated by your Service Provider.

In this publication we use “phone number” when referring to these numbers.

Both calls have the same dialing features.



For operating the MTM800E in RF sensitive areas, see “Transmit Inhibit” on page 44.

NOTE *If your Service Provider has restricted access to the Contacts list, it might not be possible to create a new contact, edit existing contacts or dial up a number which is not in the Contacts list.*

NOTE *While Transmit Inhibit is activated, an incoming Phone or PABX Call is indicated, but it is not possible to answer the call.*

Making a Phone or PABX Call

NOTE *If you are in an on-going Group Call wish to make a new call, press  to ignore the current call. Dial the number.*

1. From the Home display dial a number.
2. If Phone or PABX are not the first type of call presented, press **CType** repeatedly to select the Phone or PABX Call type.
3. Press and release . You will hear a ringing tone. Wait for the called person to answer your call.
4. To end the call, press .

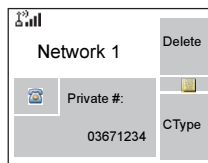

Other Ways of Dialing

Dialing via the Contact List

You can also use the contact list to select a number you previously stored. Press **Contacs** and search the stored number by scrolling (⬅️ or ➡️) or by entering up to 12 characters of the contact name. If the contact has more than one number, use ⬅️ / ➡️ to select the number.

NOTE *If no name is stored under a letter, the MTM800E searches forward, alphabetically, until the next name is found. If more than one name in the list begins with the same letter, press up to 12 characters.*

If the contact has more than one number stored, pickers surround the contact icon. Use ⬅️ / ➡️ to select the number.

Speed Dial

Speed dial allows you to dial a shortened number of up to three digits instead of the full number. The speed dial number is the location of an entry in the contact list.

1. Enter the pre-programmed speed dial number (for example: 5) and press .
2. To place the call, press .
3. To hang up, press .

NOTE *This feature is available only in TMO.*

Talk Group Dialling by Index

Talk Group dialling by index allows you to dial the index of the TG and  instead of going through the menu and picking the correct group.

One-touch Dial

One-touch dialing allows you to place a call by pressing and holding one of the keys (1-9).

1. Press and hold the required key for a few seconds. Your MTM800E will display the number and dial it.
2. To hang up, press .

NOTE *If programmable one-touch keys are enabled, one-touch dial is disabled (see page 18).*

DTMF Overdial

If set up by your Service Provider, DTMF allows you to communicate with an automated answering device (for example, the voice mail or answering machine) during an on-going private, phone or PABX call.

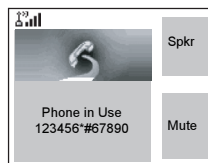

While in an on-going private, phone or PABX call, press the DTMF keys (0-9, *, #). When pressed, the DTMF key will sound a tone and the entered digit will be displayed on the screen.

MS-ISDN

This feature adds to the radio ISDN number. Users can choose between MS-ISDN and ISSI to address the call, send the message or pre-defined templates. It works for both simplex and duplex calls, based on the assigned ISDN number.

Recent Calls List

Select the number from the recent call list. See “Recent Calls” on page 138.



Calling a Number in a Message

See “Calling a Number in a Message” on page 157.

Dialing on receiving a call

See “Dialing on Receiving a Call” on page 63.

Answering a Phone or PABX Call

1. The MTM800E switches to the incoming Phone/PABX Call.
2. To answer the incoming call, press  or any other key if programmed (except Home/End/On-Off key).
3. To end the call, press .

If the called person or the infrastructure end the call, the **Call Ended** message is displayed.

NOTE *For call alert, see settings in the Tones menu option (page 123).*

Emergency Operation

General

Emergency Operation is available in TMO and in DMO, if the MTM800E is in service.

Emergency Mode indication (alert tones) can be disabled by your Service Provider.

Entering TMO or DMO

See “Selecting TMO or DMO Operation” on page 23.

Important Information

NOTE

- *The required time you need to press the Emergency button is set by default to 0.5 seconds. The time can be configured by your Service Provider.*
- *Pressing the Emergency button can be used to activate one or more services:*
 - *Emergency Mode*
 - *Sending Emergency Alarm*
 - *Starting Hot Mic operation*
 - *Starting emergency individual call*
 - *Powering up the terminal*
 - *Sending the GPS location information, if this option is enabled by your Service Provider*
- *Pressing the Emergency button even if Transmit Inhibit is activated causes immediately the MTM800E to transmit. When entering Emergency Operation the MTM800E should not be within the RF sensitive area any longer!*
- *The MTM800E interrupts the AL call when you press the Emergency button.*
- *For call alerts, see settings in the Tones menu option (page 123).*

An Emergency Group Call is configured as non-tactical or tactical:

- A non-tactical call initiates on a talkgroup designated by your Service Provider. The group might be different than the one displayed on the terminal screen when starting the call.

After exiting from non-tactical emergency mode the terminal will be attached to the group that was selected before initiating the non-tactical call. When in non-tactical emergency mode, you will not be able to switch talkgroups.

DGNA messages have no impact during non-tactical emergency mode but only after exiting the non-tactical emergency mode.

- A tactical call initiates on the currently selected talkgroup.

Emergency Call

You are able to make an Emergency Call either by PTT or emergency button/footswitch (when in Emergency Mode), if it is enabled. Radio provides the information about the current active Emergency Call. If the Emergency Calls are disabled you are going to see PTT Denied on the screen.

Emergency Power Up during PIN Lock

Terminal enters Emergency Mode without PIN Lock prompted no matter if in service or not. When you exit the Emergency mode, the terminal will go back to the PIN Lock entry screen.

Alarm Addressing

Address type is Private, message is sent to predefined individual address.

Address type is Group:

- Tactical - message send to attached talkgroup
- Non-Tactical - message send to predefined group defined in GSSI/ISSI

- If both types are not selected, alarm will be send to the address given by Service Provider.

Emergency in TMO

Overview

Please check with your Service Provider for the configuration of your terminal.

Your terminal may be configured with one of the following:

Emergency Group Call

The terminal will enter **Emergency Mode** when you press and hold the Emergency button.

The Emergency Mode allows you to use the **PTT** to transmit with Emergency priority (by either initiating an Emergency Group Call or requesting emergency transmit priority).

After entering Emergency Mode, you may send an Emergency Alarm (if configured) and then start the Emergency Group Call and activate Hot Microphone (if configured).

The **Emergency Alarm** is a special Status message sent to the infrastructure before the Emergency Group Call starts. The terminal may wait for infrastructure acknowledge for this Alarm and attempt retries. Each time you press the Emergency button, the terminal will send an Emergency Alarm.

Hot Mic (Hot Microphone) allows you to talk without pressing the **PTT**. Pressing **PTT** during Hot Mic ends Hot Mic transmission. Pressing the **End** soft key ends Hot Mic activity. If Hot Mic is disabled, then use **PTT** to talk.

Emergency Private Call (Simplex or Duplex)

The terminal will start an **Emergency Private Call** to a pre-defined ID when you press and hold the **Emergency** button.

If an Emergency Private Call gets modified to an Emergency Group Call, the terminal will enter Emergency Mode and will leave the Emergency Mode when the call ends.

Emergency Private Call and Emergency Alarm

If the address type is set to Private and Emergency Alarm is enabled, press the Emergency button to send the emergency alarm to the address configured by the Service Provider.

When those requirements are satisfied the Emergency Call is initialized.

Changing Folder or Group

See Group Call section on page 35.

Entering or Exiting Emergency Mode

Upon entry into Emergency Mode any existing call or service other than packet data service will be aborted or cleared down.

In Emergency Mode, the terminal will automatically reject Phone, PABX and Private Calls, and will not monitor the groups in the user selected scan list. If an ATG is the selected group, however, the terminal will monitor the sub-groups associated with the ATG. The terminal will remain in Emergency Mode until you exit it.

Press and hold the Emergency button to enter Emergency Mode.

When the MTM800E is **Off**, press this button to power the MTM800E **On** in Emergency Mode (if configured).

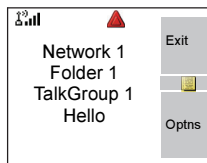

The terminal exits Emergency Mode and switches to the Home display:

- If you press and hold the **Exit** soft key during an Emergency Group Call.
- If the infrastructure ends the Emergency Group Call.

Sending an Emergency Alarm

Your MTM800E will send an Emergency Alarm to the dispatcher (if configured by your Service Provider):

- Automatically, upon entering Emergency Mode.
- If you press the Emergency button while the MTM800E is in Emergency Mode.
- If you change group while in Emergency Mode.

The screen will show one of the following delivery reports:

- **Alarm Sent**
- **Alarm Failed**

In both cases, the screen returns within a few seconds to the main screen of the Emergency Mode.

Due to no delivery confirmation in DMO, **Alarm Sent** information confirms only sending the alarm.

Or - if configured by your Service Provider - your MTM800E will send an Emergency Alarm:

- If you press the Emergency button without entering Emergency Mode before.
 - > Other Emergency services such as starting TMO Emergency Mode or initiating Emergency Private Call will be unavailable.
 - > No visible and audio indication on sending Emergency Alarm will be done.

NOTE

Some systems do not support the Emergency Alarm feature when the user is in a "Local Area Service" area (see page 31).

Making an Emergency Group Call

NOTE *While in an Emergency Group Call, you can still perform group operations (such as changing group/folder, searching for a group, or entering the My Groups folder).*

To initiate or answer a call while in Emergency Mode:

- Press and hold **PTT**.
- Wait for the talk permit tone (if configured) and talk.
- Release **PTT** to listen.

For the delivery reports, see “Sending an Emergency Alarm” above.

You can also participate in an Emergency Group Call (initiated by others) in Emergency Mode or in a standard Group Call.

Hot Microphone Feature in TMO

If the Hot Microphone feature was programmed into your MTM800E by your Service Provider, you can make an Emergency Group Call without the need to press and hold the **PTT**.

The following will happen upon entering Emergency Mode:

1. The MTM800E will automatically send an Emergency Alarm to the dispatcher (if configured by your Service Provider).
2. A Talk permit tone will be heard.
3. The following typical display will appear: The microphone will stay open for a time period determined and programmed by your Service Provider.

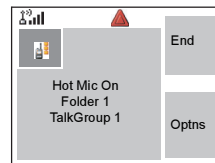

After the Hot Microphone time period expires, or if you press **PTT** during the Hot Microphone period, or if you press **End** soft key: the **Emgcy Mic Ended** message will be displayed. The talk session ends. To resume, press the Emergency button again. Your radio can also resume the Hot Mic session automatically when the **Alternating Hot Mic** feature is enabled. Talk permit time is granted without any user interaction. The same screen indication is displayed as for regular Hot Mic.

NOTE *Talk time and the time between regular Hot Mic and the Alternate Hot Mic is specified by your Service Provider.*

If talk permit is granted to another member of the group, an “Emergency call received” tone will be heard. If configured by your Service Provider, your MTM800E will automatically attempt to get talk permit again and the **Wait For Mic** message will be displayed.

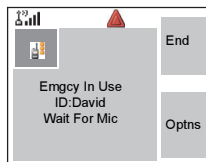

NOTE *During this pending time the MTM800E microphone is not active until the Emgcy Mic On message is displayed again.*

NOTE *Hot Microphone feature is available in DMO and TMO modes.*

Receiving an Emergency Group Call

A terminal in TMO receives an Emergency Group Call to the selected group, associated ATG (Announcement Talkgroup), or scanned group. If the ATG is the currently selected group, the terminal will receive the Emergency Group Call to the group associated with this ATG. (For information on the ATG, see page 35.)

When the MTM800E receives the call, the display will show **Emgcy In Use** and the caller’s identity.

If upon entering Emergency Mode, your MTM800E receives an Emergency call, and Hot Microphone was enabled by your Service Provider, the Wait For Mic message will be displayed. Your MTM800E will attempt to get a talk permit.

The caller's voice will always sound via the speaker.

If configured by your Service Provider, the screen background will be red.

Making an Emergency Private Call

1. Press and hold the Emergency button.
2. The terminal will start the call as a Simplex or Duplex call (as programmed). The Emergency ID is pre-defined and is not displayed.
3. Continue the call as you would do in a Simplex or Duplex call.

Receiving an Emergency Private Call

1. The talker's identity is displayed when the terminal receives the Simplex call.
2. When the terminal receives the call, the display will show **Emergency Prvt In Use** and the caller's identity.
If configured by your Service Provider, the screen background will be red.
3. Continue the call as you would do in a Simplex or Duplex call.

Modifying the Type of Call

The infrastructure can modify on-going calls as follows:

- Emergency Group Call to Emergency Private Call, and vice versa.
- Anyone of the above to a Phone Call.

If Hot Mic is interrupted when the modification occurs, the display will show the **Emgcy Mic Ended** message.

Continue the modified call depending on the type of call.

Silent Emergency Mode

Silent Emergency mode is a type of emergency services that provides no audible indications and no keypad tones at the entrance. Silent Emergency alarm is sent to the group or a user defined by the Service Provider. All the screen indications are kept as it is for the normal mode but the radio cannot use any of the services except:

- receiving Ambience Listening.
- sending Silent Emergency alarms.
- sending GPS signal based on SDS application.

Entering the Silent Emergency Mode

To enter Silent Emergency mode the user needs to press the Emergency button.

NOTE *This feature needs to be enabled by your Service Provider.*

Exiting the Silent Emergency Mode

To exit the Silent Emergency mode:

- user initiates it by pressing **Menu** and then **#** key within 3 seconds.
- the Silent Emergency alarm is not successful or it is rejected

NOTE *Count of the efforts and duration that your radio waits for the reply of the alarm are set by the Service Provider. This can be only interrupted when the user exits the Silent Emergency mode.*

- ambience listening terminates.

Silent Emergency Mode interactions

User presses the Emergency button while in Silent Emergency

- radio sends silent emergency alarm.
- radio provides no audible/visible indication.

NOTE *In Silent Emergency Mode when the battery is removed the radio will turn on again in the normal mode.*

Silent Emergency and TMO/DMO Mode

As the Silent Emergency is only available in TMO, radio will change the mode from DMO to TMO. When the user is in a private or group call, Silent Emergency waits until any of the calls is ended to change the mode and enter the Silent Emergency Mode.

NOTE *If the Silent Emergency mode enters after the call the only change on the display is the Private/Group notice which disappears.*

Power off in Silent Emergency mode

If user initiates the power off while in Silent Emergency mode the radio goes to pseudo power off state. In this state audio and visible indications are turned off but the radio is still on in the Silent Emergency mode as before.

NOTE *If the radio exits the Silent Emergency mode after powering off in it, the radio shuts down without any indication.*

Power on in pseudo power off

User presses the Emergency button, the radio indicates power on but it is still in Silent Emergency mode.

Silent Emergency mode and PIN protect

The radio enters the Silent Emergency mode while in the PIN protected state, it asks the user for the unlocking code. When the radio exits the Silent Emergency mode, it is still in the PIN protected state.

Emergency in DMO

Overview

You can initiate an Emergency Group Call to a group.

You can receive an Emergency Group Call:

- From the selected talkgroup
- From other users within talkback range (if configured by your Service Provider). This is called an InterMNI call.

- From an open group. (An open group is a super-group to which all DMO groups belong.)

Emergency calls can be placed via gateway and repeater. For gateway and repeater settings, see “Gateway/Repeater Selection” on page 49.

Hot Microphone Feature in DMO

This functionality allows the user, that is in emergency situation, to be heard without pressing the PTT. It needs to be enabled by your Service Provider for DMO mode. For the detailed functionality please see Hot Microphone Feature in TMO.

NOTE *When the radio is in emergency mode and it switches from TMO to DMO (and vice versa), the Hot Mic feature is still active.*

Changing Folder or Group

Proceed as explained in the Group Call section, “TMO Group Call” on page 35.

Making an Emergency Group Call

To initiate or answer a call:

1. Enter Emergency Mode by pressing the **Emergency** button.
2. Press and hold **PTT**.
3. Wait for the talk permit tone (if configured) and talk.
4. Release **PTT** to listen.

NOTE *Your MTM800E enters TMO by pressing the **Emergency** button (if configured by your Service Provider). The terminal attaches to the predefined talkgroup and starts the Emergency Group Call. If the predefined talkgroup is invalid the terminal attaches to the last selected talkgroup.*

Receiving an Emergency Group Call

1. The display shows **Emgcy In Use** and the caller's identity as a private number or an alias.
2. The caller's voice will always sound via the speaker.

If configured by your Service Provider, the screen background will be red.

- If the incoming call is an InterMNI call in Emergency Mode, you can view network information by pressing **Optns** and selecting **Network**.
- If the incoming call is an InterMNI call *not* in Emergency Mode, you can view network information by pressing **Network**.

Using the Browser

The WAP (Wireless Application Protocol) browser provides services (such as database access) to the terminal. Check with your Service Provider for the availability of this feature.

NOTE *WAP is only available on the Master Control Head in the Dual Control Head configuration. User working on Slave Control Head by pressing  can only end the WAP session.*

Icons

Icon	Description
	Browsing via Wireless Transport Security (WTLS) to https://... site

NOTE *In non-secure browser session, the Packet Data icons are displayed. (See “Status Icons” on page 12.)*

Entering/Exiting the Browser

Enabling Browser Entry

If the Service Provider configured the browser feature in your terminal, the Browser option will be listed third in the main menu.

If not, the Security option will be listed third.

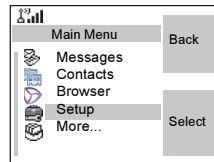

Entering/Exiting the Browser

1. Set Packet Data to **Voice & Data** or **Data Only** (see “Setting Up the Data Function” on page 121).
2. From the main menu, press **Menu** and select **Browser**.
3. The display shows one of the following:
 - Clear screen (first-time activation after power up), then your home page.

- The last page you navigated to if you re-activate or resume the browser.

NOTE *Information on the last page is recovered from the cache if the page time did not expire and if the browser has enough memory to restore it from the cache at that time.*

- browser menu, if Packet Data is not available. See “Disabled Packet Data Service” on page 84.
4. Start browsing using the keypad, four-way navigation key, and soft keys.
 5. To de-activate the browser, press , or power off the terminal.

Entering the Browser Menu Panes

The browser menu contains panes with items required for operating the browser.

1. After entering the browser as explained on page 81, press **Menu** or **Menu** button.
2. Usually, it will bring up the Navigate pane, or the last browser menu pane you were in.

The Options pane will pop up if the web page you navigated to has two or more soft keys/options.

From here you may scroll to other panes with the left or right navigation keys.

Or you may select **Browser Menu** and then scroll to the required pane.

Tips for Browsing

Create and use the following for easy browsing.

Creating a Bookmark via Navigate Pane > Mark Page

Mark a web page for quick download.

1. Enter the browser and browse to the required page.
2. Press **Menu** to enter the browser menu.
3. Select **Mark Page**.
4. The screen displays the title and URL of the marked page.

5. Press **Save** (or **Select**) to save the page in Bookmarks.

Or select **Menu** and select an option:

- **Save** - confirms the bookmark creation.
- **Edit** - allows to edit the title, folder choice, and URL of the created bookmark.
- **Cancel** - cancels the operation.

Creating a Bookmark via Bookmarks Pane



> *New Bookmark*

1. Enter the browser.
2. Scroll to Bookmarks pane.
3. Select **Organise** (if there are no saved bookmarks), or **More...**
4. Select **Menu**.
5. Scroll to **New Bookmark**.
6. Enter the bookmark title and URL, and select its location.
7. Press **Save**.

Using a Bookmark

1. Enter the browser.
2. Scroll to Bookmarks pane.
3. Scroll to the required bookmark and select **Go**. The bookmark downloads the selected page from the web.

Creating a Hotkey

Assign a bookmark to a hotkey (keys  - ) to quickly download a web page.

1. Enter the browser.
2. Scroll to Bookmarks pane.
3. Scroll to the required bookmark.
4. Press **Menu**. Select **Hotkeys**.
5. Select an unassigned key.
6. Click **Assign**. The display shows the bookmark and its assigned hotkey.

Using a Hotkey

1. Enter the browser.
2. Press and hold a hotkey to download the corresponding bookmark from the web.

Saving a Page

Save a page (snapshot) for off-line browsing.

1. Enter the browser and browse to the required page.
2. Press **Menu**.
3. Scroll to Tools pane.
4. Select **Save Page**. Edit the proposed page title if required. Scroll down and select **Save**. The page will be saved in the Bookmarks Saved Pages folder.

Selecting a Saved Page

1. Enter the browser.
2. Scroll to Bookmarks pane.
3. Select **Organise** (if there are no saved bookmarks) or **More... .**
4. Select **Go** to enter the Saved Pages folder.
5. Select a saved page and press **OK**. The display shows the saved page. Depending on the saved page, you may browse the web from here.

Disabled Packet Data Service

If there is no Packet Data Service, the terminal displays **Error: Network Not Available** when entering the browser for the first time. Select left soft key to retry entering, or right soft key to enter the browser menu.

When re-entering the browser, the terminal displays the last browsed page if Packet Data was previously available, or the last page to which you navigated off-line.

Disabled Browser Entry

Browser entry is disabled:

- during any type of voice call, except ambience listening call
- in DMO mode
- during Emergency mode
- during PIN lock
- if the Service Provider has not configured this feature
- when the terminal is disabled.

NOTE





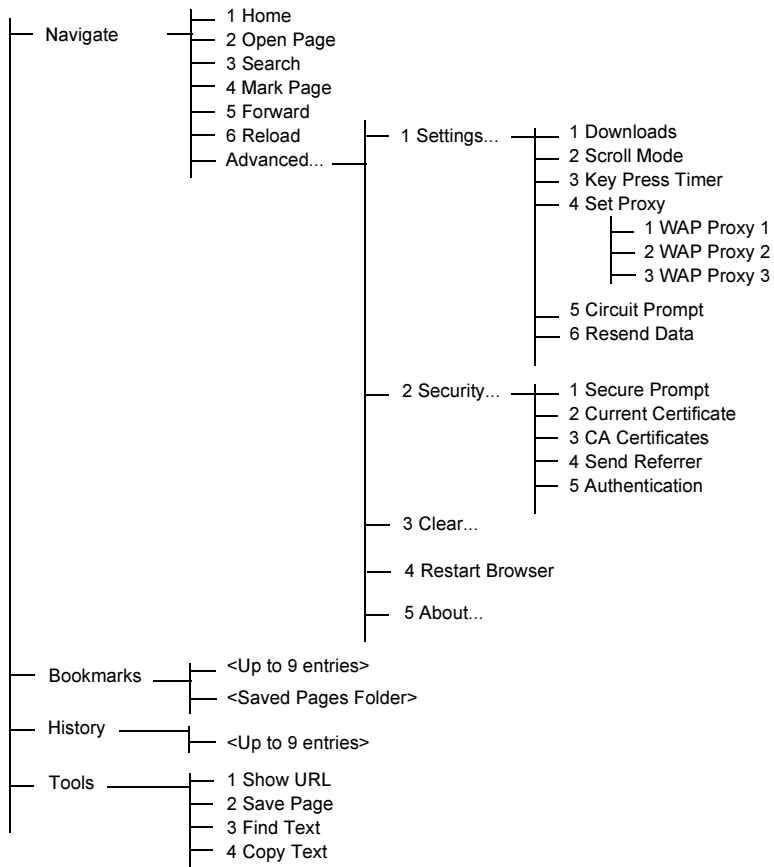







- *Browser entry is enabled during Ambience Listening (AL). If you navigate to previously stored pages, the AL state remains.*
- *When you need to activate Packet Data for the first time, AL is disconnected, and you have the same “look and feel” as if you were not in AL before.*





Browser Menu Pane Contents



Keys Usage

When the browser is active, the usage described below occurs inside or outside the editor.

Key Press	Action
Press:  to 	<ul style="list-style-type: none"> • In the editor: enters a digit and/or character depending on the text entry mode selected. • Outside the editor: in a numbered list, selects the required item list.
Press and hold:  to 	<ul style="list-style-type: none"> • In the editor: standard use • Outside the editor: hotkey for navigating to the numbered bookmark. (For this use, first assign the relevant bookmark to the specific hotkey as explained on "Creating a Hotkey" on page 83.)
Press, or press and hold 	In the editor, inserts a space.
Press, or press and hold: 	Brings up the Text Input pane, while in editor (See "Text Input Pane" on page 94). Otherwise, sounds a wrong key press.
Left and right soft keys	Selects the option that appears in the display directly above the left and right soft key (part of the page).
	While in list of options, moves up one line.
Press and hold 	Moves up on page.
	While in list of options, moves down one line.
Press and hold 	Moves down on page.
	Moves to the previous pane. In the editor: moves left
Press and hold 	Functions as Backward
	Moves to the next pane. In the editor: moves cursor to the right and inserts space if at the end of the word.

Key Press	Action
Press and hold 	Functions as Forward.
Press and hold at the centre of 	Auto-repeat
	Brings up the browser menu.
	Press to de-activate the browser.
	Disabled in browser active state.
Volume button	Used for volume adjustment only.
Emergency	De-activates the browser. The terminal enters Emergency mode.

Browser Menu Panes Overview

The browser menu includes the following panes:

Menu Pane	Description
Navigate	Provides access to the home page and commonly used items.
Bookmarks	Provides access, editing, and storage options to stored bookmarks and saved pages.
History	Provides access to recently visited pages and shows the position of the currently loaded page in the history stack.
Tools	Provides access to applications and utilities.

The following panes are displayed according to the context:

Options	Displayed only when there are additional options for the pane or page.
Image	Displayed only when an image is selected. Provides access to image details, storage, and display use.
Input Text	Displayed only in text entry mode. Provides access to text entry mode (e.g.: symbol)

Navigate Pane

Select one of the items below:

- **Home** – for loading the home page.
- **Open Page** – for entering the URL to be loaded.
- **Search** – item disabled.
- **Mark Page** – for creating (saving) a bookmark for the current document. A title and URL for the bookmark are displayed, and the root folder is chosen for the location.
- **Forward** – for navigating to the document located one step forward in the navigation history. If there is no forward history, this item is disabled.
- **Reload** – for reloading the current document.
- **Advanced...** See the following section.

Advanced...

1. From the Navigate pane, select **Advanced...**
2. The screen displays a list of items for accessing advanced browser features and settings. Select the required item.

Settings...

1. From the Navigate pane select **Advanced... > Settings...**
2. Select the required item.
 - **Downloads** – for setting download preferences. You may de-activate the downloading of images and objects. The browser will display a special icon instead of the images and objects.

- **Scroll Mode** – for setting the scrolling mode and speed.
- **Key Press Timeout** – for setting key press timeout. This timeout is used for text entry.
- **Set Proxy** – Select the WAP Proxy (1, 2, 3). The browser connects to the web via the selected proxy or gateway. The network provider installs and configures the proxy. To establish a secure session, select a secure proxy. Please ask your Service Provider which proxy is configured for a secure session.
Though you can choose your home page, the Service Provider may decide to force its own home page on your terminal.
- **Circuit Prompt** – for turning ON/OFF the circuit prompt.
- **Resend Data Prompt** – for turning ON/OFF the data resend prompt.

Security...

1. From the Navigate pane select **Advanced... > Security...**
2. Select the required item.
 - **Secure Prompt** – for enabling/disabling the browser to inform you that it replaced a non-secure connection with a secure connection, and vice-versa.
 - **Current Certificate** – for viewing the digital certificate identifying the server that delivers the current document. A Certificate Authority (CA) digitally signs and thus authenticates this certificate. Up to 10 additional custom WTLS certificates can be added to the default list of certificates installed. Please ask your Service Provider if you wish to have these custom WTLS certificates added.
 - **CA Certificates** – for viewing the digital certificates installed in the browser and digitally signed by Certificate Authorities (CA).
 - **Send Referrer** – for turning ON/OFF sending of the HTTP Referrer header as part of HTTP requests. The Referrer header provides the URL of the link source to the server.

- **Authentication** – for turning ON/OFF the caching of HTTP Authentication credentials. HTTP Authentication protects access to content on the server. If you try to access a protected content, you will be asked for your credentials (user name or password).

Clear...

1. From the Navigate pane select **Advanced... > Clear...**
2. Select clearing of browser data: history, cache, cookies, or auto-fill.

Restart Browser

1. From the Navigate pane select **Advanced... > Restart Browser.**
2. The browser restarts, clearing the history.

About ...

1. From the Navigate pane select **Advanced... > About...**
2. The display shows information about the current version of Openwave Mobile Browser.

Bookmarks Pane

If there are bookmarks in the root folder, select **More...** to access the Options pane.

If the root folder is empty, select **Organise...** then press **Menu** to access the Options pane.

The Options pane allows you to manage bookmarks.

The Saved Pages folder contains snapshots of saved pages.

Working with the Options Pane for a Selected Bookmark

1. From the Bookmarks pane select **More...**
2. Scroll to a bookmark.
3. Select **Menu** to open the Options pane for that bookmark.

4. Select an option:

- **Back** – for displaying the page associated with the bookmark (page is downloaded if not available in cache).
- **Details** – for modifying the bookmark title and URL.
- **Delete** – for deleting the bookmark.
- **New Bookmark** – for creating a new bookmark.
- **New Folder** – for creating a new folder.
- **Move** – for moving this bookmark to a new folder (or in Bookmarks).
- **Delete All** – for deleting all bookmarks.
- **Hotkeys** – for assigning hotkeys ($\boxed{0+\phi}$ - $\boxed{9_{xyzj}}$) to available bookmarks.

Working with the Saved Pages Folder

1. From the Bookmarks pane select **Saved Pages** folder.
2. The browser displays the page (snapshot) saved using Save Page in Tools pane.
3. Scroll to a saved page.
4. Select **Menu** to open the Options pane for the saved page.
5. Select an option:
 - **Back** – for displaying this page saved on its cache.
 - **Details** – for modifying the page title and URL of the saved page.
 - **Update Page** – for replacing the saved version with the current version (to be downloaded from server).
 - **Delete** – for deleting this page from its cache.
 - **Delete All** – for deleting all the saved pages from its cache.
 - **Cancel** – for exiting this pane and returning to the last page displayed.

History Pane

This pane displays the list of recently-visited pages (up to nine history entries can be listed). Each history entry shows its title, if present. (Otherwise, “No Title” is displayed.)

To navigate to a recently visited URL:

1. Select the URL.
2. Press the **OK** softkey.

To access the history:

1. Select **More...**, then select **Menu** to display the Options pane.
2. Select an option:
 - **Show URL** – for showing the URL of the selected history entry.
 - **Delete** – for deleting the selected history entry.
 - **Delete All** – for deleting the list of history entries.
 - **Exit** – for exiting the Options pane.
 - **Next History** and **Prev History** – for accessing the next and previous entries page, respectively.

Tools Pane

1. From the Tools pane select **More...**
2. Scroll to a document.
3. Select **Menu** to open the Options pane for that document.
4. Select an option:
 - **Show URL** – for displaying the current document’s URL.
 - **Save Page** – for creating a snapshot for the current document.
 - **Find Text** – for finding a text string in the current document.
 - **Copy Text** – for copying text from the current document to the terminal’s clipboard.

Options Pane

This pane is specific to the page or pane being displayed.

Image Pane

This pane appears in the browser menu if you enabled the download of images via **Navigate pane > Advanced... > Settings...**

The following items are available:

- **Save** – for saving the image in the terminal.
- **[Send]** – for sending the image to the destination of your choice.
- **Reload** – for reloading the image.
- **Details** – for displaying the image details.
- **Show Image** – for showing the image on its own page.

Text Input Pane

This pane is visible when the browser menu is opened and text entry field is active. The browser has several text entry modes, depending on the type of input required.

For example, to enter a URL extension when typing a URL:

1. Type the URL.
2. Press the **abc** soft key. The Text Input pane opens up.
3. Scroll to **www**.
4. Press the **www** soft key.
5. Scroll the required extension (for example: **.com**).
6. Press the **.com** soft key. The screen displays the URL with the selected extension.

WAP Box

Mode	Soft Key	Action
Alphabetic characters - lower case	abc	Enter text in lowercase
Alphabetic characters - upper case	ABC	Enter text in uppercase
Symbols	Sym	Enter symbols
Numeric	123	Enter numbers.
http mode	www	Enter



NOTE This feature needs to be enabled by your Service Provider and it is unavailable in DMO.

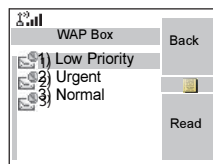

MTM800E is able to receive the notifications sent from your Service Provider. It contains the URL to the service, which can be loaded immediately or stored as a message in WAP Box. Then it can be accessed by entering main Menu > **Messages** > **WAP Box**.



All the WAP Push messages are passed to the Browser. More about “Using the Browser” on page 81.

The following icons indicate the status of messages in the WAP Box:

WAP Box Icon	Description
	WAP Message Icon Displayed next to the priority in the message list view.
	WAP Message Title Icon Displayed next to the title along with the text.

WAP Box Icon	Description
	WAP Message - Created Displayed next to the create date.
	WAP Message - Expired Displayed next to the expiry date.

Message View

Shows the title, URL, delivery time and when the message expires.

Press **Go to** to open the link in the browser.

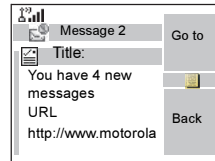

Submenu of the WAP Box includes:

- Select **Open Link** and press **Select** to open it in the browser.
- Select **Delete** and press **Yes** to delete the WAP message. When the display shows "**Deleted: Message n**", the current message is deleted from the WAP Box.
- Select **Delete All** and press **Yes** to delete all the messages. When the display shows "**Deleted: All Messages**", all the messages are deleted from the WAP Box.
- Select **Refresh** to re-order the WAP Box list and see new messages (if any).

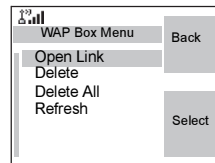

New WAP Message Received

Types of the WAP Messages and their priorities:

NOTE *Service Provider sets the priority of the message.*

- Push Message - 
 - > High - animation and the icon (blinking) are displayed with the New WAP Message tone
 - > Medium - animation and the icon are displayed with the New WAP Message tone
 - > Low - icon is displayed with the New WAP Message tone
 - > Delete - available only if the user is in WAP Box, the text **Message Deleted Remotely** is displayed, otherwise there is no indication.

NOTE *Animation is not displayed if the user is in a call, or in Emergency mode, or in Call Out, or in message editor, or PIN lock state, or switching to DMO.*

- Load Push Message - 
 - > High - Browser opens to the user with the New WAP Message tone
 - > Low - the icon is displayed with the New WAP Message tone

NOTE *Browser does not open if the user is in a call, or in Emergency mode, or in Call Out, or in message editor, or PIN lock state, or switching to DMO.*

To check the tone related to WAP Box, please go to “New WAP Message” on page 187.

GPS Location Service

Your terminal's GPS Location feature uses information from Global Positioning System (GPS) satellites orbiting the Earth to determine the approximate geographical location of your terminal. The availability and accuracy of this location information (and the amount of time that it takes to calculate it) will vary depending on the environment in which you are using the terminal.

For example, GPS location fixes are often difficult to obtain indoors, in covered locations, between high buildings, or in other situations where you have not established a clear broad view of the sky.

SEE: IMPORTANT - Things to Keep in Mind.

The GPS location Service can assist your Dispatcher or Colleagues in many ways such as more efficient deployment of resources or locating your terminal if you trigger your emergency service.

The terminal can be configured to display location information on the terminal's display or to send it over the air to your dispatcher where it can be displayed in control center (Please check with your Service Provider on the configuration of your terminal).

It is possible to send the location information in TMO via Packet Data, if the user activate this feature.

IMPORTANT - Things to Keep in Mind

Where adequate signals from multiple satellites are not available (usually because your terminal cannot establish a view of a wide area of open sky), the GPS feature of your terminal **WILL NOT WORK**. Such situations include but are not limited to:

- In underground locations
- Inside of tunnels or parking garages

- Under any other metal or concrete roof or structure
- Near a powerful radio or television tower
- When your GPS antenna is covered (for example, by your hand or other object) or facing the ground
- In temperature extremes outside the operating limits of your terminal

Even where location information can be calculated in such situations, it may take longer to do so. Therefore, in any emergency situation, always report your location to your dispatcher.

Furthermore, please note that even where adequate signals from multiple satellites are available, your GPS feature will only provide an approximate location, often within 20 - 100 meters from your actual location.

Enhancing GPS Performance

Sometimes the GPS feature of your terminal may be unable to complete a location calculation successfully. You will then see a message indicating that your terminal cannot see enough visible satellites.

To maximize the ability of your terminal to determine a location fix please note the following guidelines:

- The GPS feature works best where there is nothing between the GPS antenna and a large amount of open sky. If possible, move your vehicle away from tall buildings and foliage. While performance in a building is improved by moving closer to windows, glass with certain sun shielding films may block satellite signals.
- Position your vehicle to enhance reception, giving the antenna clear access to satellite signals. Signals from GPS satellites are transmitted to your GPS antenna. Do not cover the antenna area with your fingers or anything else.

- Stay in network coverage. Depending on who your service provider is, the network will provide your terminal with information that helps determine your location more quickly and accurately.

GPS Icon

When your terminal is receiving valid GPS location data, a GPS icon will be shown in the display:



Please note, that during Emergency mode, your terminal will not display the GPS icon even when receiving GPS location data. If valid GPS location data is available when you leave emergency mode the GPS icon will be displayed again.

GPS Enable/Disable

1. From the main menu, press **Menu** and select **More... > Location > Interface**.

The current selection (**On/Off**) is highlighted.

2. Select the new choice. The display shows:

On – Location Service On

Off – Location Service Off

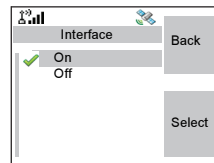

Entering GPS Location Service

To enter the GPS sub-menu, press the **Menu** button and select **More... > Location**:

Position – provides the actual position information.

Interface – allows you to enable/disable the GPS location service.

Scroll to your selection and press **Select** to access the next display.

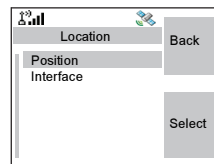

This estimate of accuracy of the calculated location is only a very rough estimate and may vary substantially from the actual accuracy of the approximate location information reported.

NOTE *This feature works in DMO and TMO modes when it is set by the Service Provider.*

NOTE *The variation will vary in accordance to the GPS Configuration set by your Service Provider.*

The availability of the GPS Location menus is dependent on your terminal configuration, please contact your Service Provider for further details.

Viewing Your Position

1. From the main menu, press **Menu** and select **More... > Location > Position**.
2. Scroll to view the entire screen.

This displays the following information about the last time your location was calculated (if available):

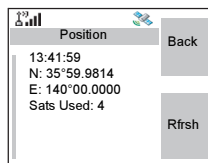

- The **time** the location was last calculated
- The **latitude** expressed in degrees, minutes, and seconds
- The **longitude** expressed in degrees, minutes, and seconds
- The **number of satellites** used to calculate the location. In general, more satellites make for better accuracy. The maximum is twelve satellites.

To calculate your location again, press **Refresh**.

For the users from United Kingdom and Ireland there are two letters (for UK) or 1 letter (for IRL) displayed. This feature needs to be enabled by the Service Provider.

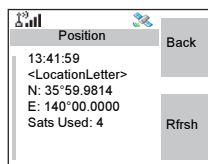

It may take your terminal several minutes to complete the process of determining your location. During this time, a message usually appears on your terminal's display stating:

- Insufficient Visible Satellites, or
- Insufficient Visible Data

For tips on getting the best location calculation, see "Enhancing GPS Performance" on page 100.

The **Position** screen displays the updated information.

To cancel a location calculation before it is completed:

Press **Back** to return to the previous screen.

Each time approximate location of your terminal is calculated, the latest location information is stored in your terminal and remains there even when your terminal is powered off. You will see this information the next time you view the **Position** screen.

If you received a terminal call or alert while attempting to determine your location, the **Position** screen will disappear, but your terminal will continue attempting to determine its location. If it is successful, the new location information will be displayed the next time you view the **Position** screen.

The Menu

To Enter the Menu Items

You can enter the menu items during a call. If you are viewing a menu when a new call starts, the terminal will exit the menu.

1. Press **Menu**.

2. Scroll to the required item, press **Select** or  to select.

Or use shortcuts to access frequently-used menu items.
(See “Shortcuts” on page 140.)

If the menu item contains a further set of menu items as in the example below, repeat step 2.

Navigating Menu Items

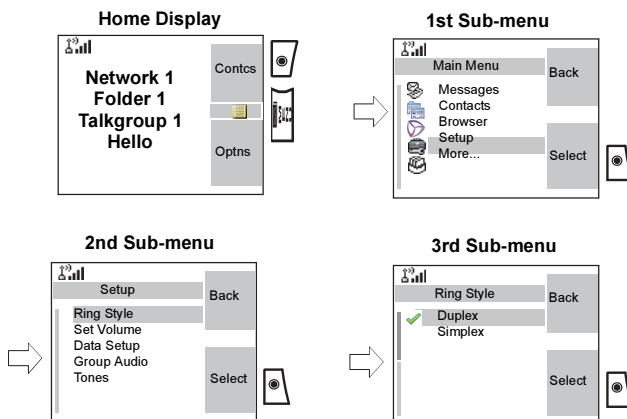

When scrolling up/down menu items, try also right/left scrolling. (This will select the item or return to previous level.)

In a list press and hold  for automatic scrolling.

To Return to the Previous Level

Press Back or .







To Exit the Menu Items

Press .

NOTE Your MTM800E may exit if no key presses are detected for a time-out period.

Menu Icons

The following icons make it easy to identify the menu items at first glance.

Menu Icon	Description
	Main Menu Items/Context Sensitive Menu Appears above Menu if the main menu items/ context sensitive menu are active.
	Messages <ul style="list-style-type: none">• Send status messages,• Send text messages (free text or according to user defined or predefined templates),• Received messages in Inbox.
	Contacts Add, search, edit, or erase entries in the contact list.
	Security Lets you turn On/Off and verify security features, and change passwords.
	Setup Allows you to customize your MTM800E.
	More... Contains more customisable menu items.
	Scroll Bar Indicates navigation among items that occupy more than one screen. If all items appear in one screen, the scroll bar is empty.

List of Menu Items

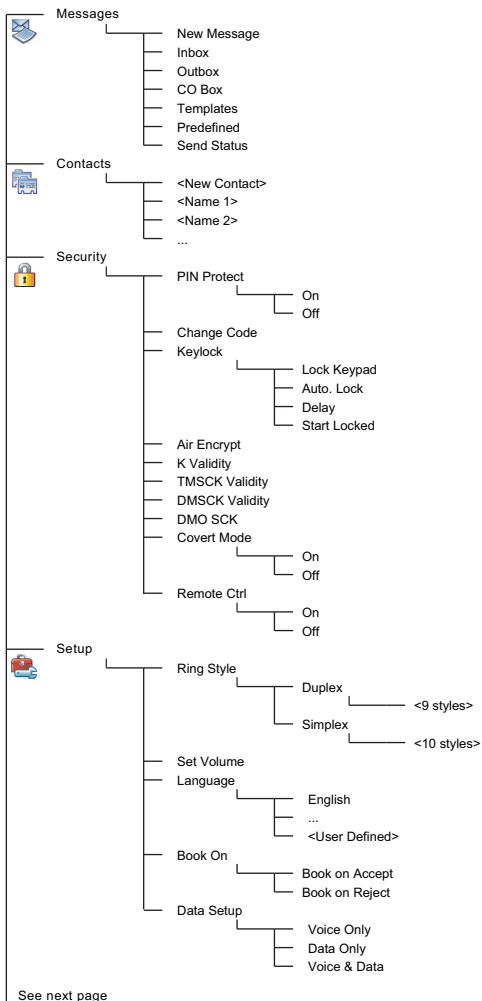

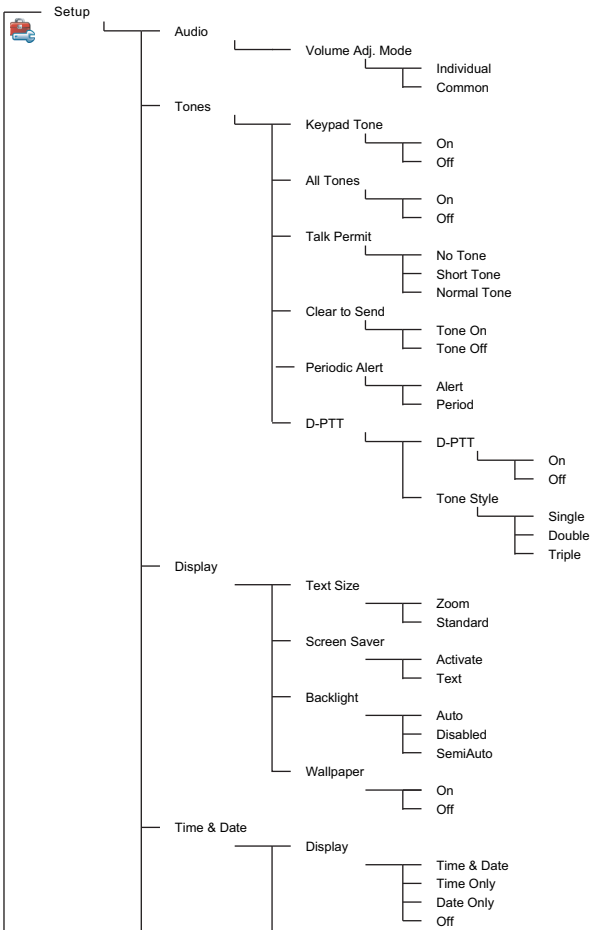

See next page

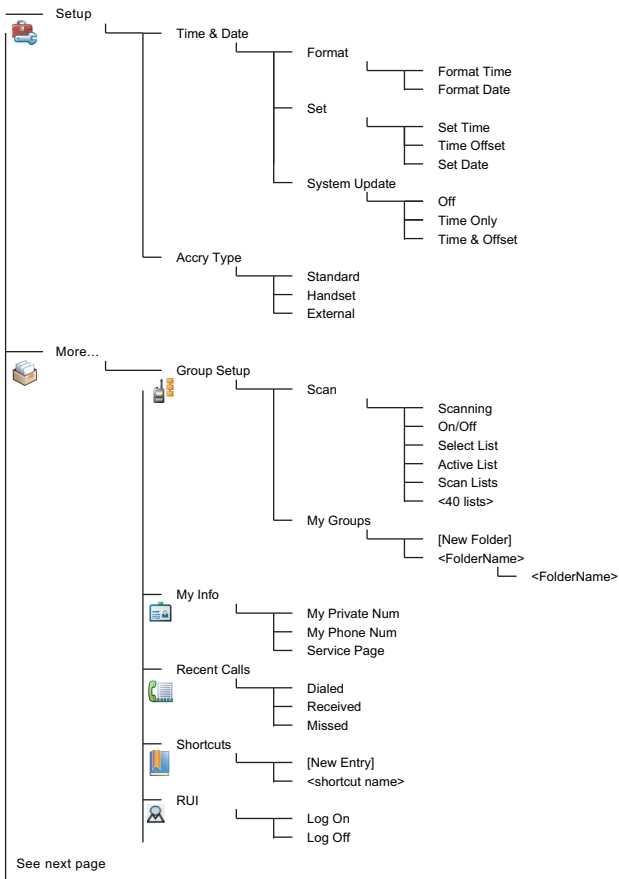

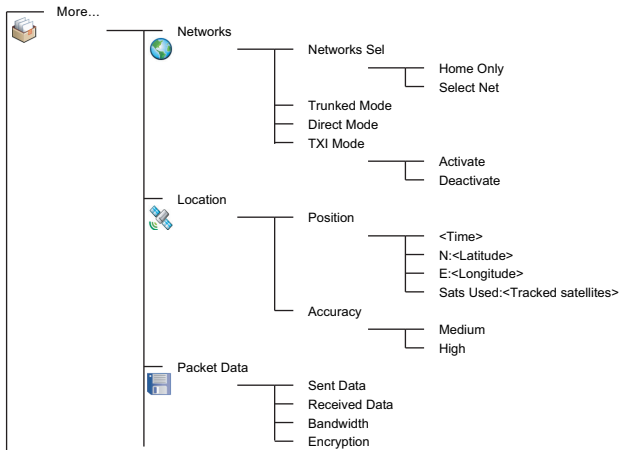

NOTE *This is the standard menu layout. Your Service Provider may enable/disable some menu items or change their names.*

Messages

Refer to “Messages” on page 151. for details.

Contacts

General

Contacts stores Private, Phone, and PABX numbers. Each Contacts entry can store several numbers. A Contacts entry contains:

- A **Name** – A name is required if you are storing more than one number to the entry; otherwise, it is optional. Typically, this is the name of the person whose contact information is stored in the entry.
- A **Contacts type** – Each number stored must be assigned a Contacts type.
- A **Number** – Each Contacts entry must contain a number. This may be any type of phone number and Private ID.

- A **Speed Dial number** – When you store a phone number, it is assigned a Speed Dial number. You can accept the default Speed Dial number or change it.

NOTE







If set up by your Service Provider, it is not possible to create or edit Contacts or dial a number which is not in the Contacts list. The menu items for creating, editing, and deleting Contacts are not available.

NOTE

Speed Dial Number is not assigned to a Private type contact.

Contact Icons

In the contact list display, the following icons may appear next to the contact numbers to indicate the type of stored number.

Contact Icon	Description
	Private ID Number
	Mobile Phone Number
	Home Phone Number
	Work Phone Number
	PABX Number
	Other Phone Number
	Pickers Indicate more than one number is stored with the contact.

Creating a Contact

1. From the Home display, press **Contcs**. Select **[New Contact]**.
Or - from the main menu select **Contacts**. Select **[New Contact]**.
Or - while editing the list from the Contacts Menu, select **[New Contact]**.

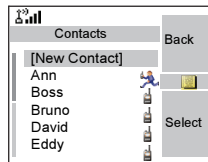

2. Enter name. (For details on text editor use, see “Writing Text” on page 167.). Press **Ok** to confirm.
3. Scroll left or right and select the type of stored number (such as Private).
4. Enter number (#). Press **Ok**.
5. Scroll up and down the entries. Continue to enter other types and numbers, as you may keep several numbers (Private, Mobile, Home, Work, PABX, Other) for the same person under the same contact name. To correct an entry, press **Change**.
6. When finished, press **Done**. Press **Back** to return to Home display.

Editing a Contact

1. From the contact list, scroll to the entry you want to edit.
2. Press the **Menu** button to enter Contacts. Select **Edit**. The entry details screen displays.
3. Follow the instructions in “Creating a Contact” on page 112. to edit the various fields.

Deleting a Number

1. From the contact list, scroll to the entry that contains the number you want to delete.
2. Scroll left or right to display the contact type for the number you want to delete.
3. Press **Menu**.
4. Select **Delete Number**.
5. Press **Yes** to confirm.

NOTE *If an entry contains only one number, deleting the number deletes the entry.*

Deleting a Contact

1. From the contact list, scroll to the entry you want to delete.
2. Press **Menu**.
3. To delete the entire entry, select **Delete Contact**.
4. Press **Yes** to confirm.

Checking Capacity

To see how many numbers are stored in Contacts:

1. From the contact list, press **Menu**.
2. Select **Capacity**.
3. Select **Contact** to check. Select **Back** to exit.

Security

From the main menu, select **Security** or **> More... > Security** (see the note on page 110).

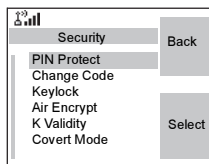

PIN Protect

Network access protection is configured by your Service Provider:

- No access to network operation – you can only send or receive Emergency Calls and adjust the volume level. Unit lock takes effect at the next power on.

To protect access to network operation:

1. From the main menu, select **Security > PIN Protect**. **On** is highlighted.
2. Press **Select**.
3. At the **Code** prompt enter the 4-digit code (factory setting 0 0 0 0). To avoid disclosure of the code, asterisks are displayed instead of the code digits. The display will show the following message:

Unit Locked – you entered the correct code. The display returns to the Security sub-menu and shows the active setting: **On**.

To unlock the MTM800E before powering off:

1. From the main menu, select **Security > PIN Protect**. **Off** is highlighted.
2. Press **Select**.
3. At the **Code** prompt enter the 4-digit code. The display will show the following message:

Unit Unlocked – you entered the correct code. The display returns to the Security sub-menu and shows the active setting: **Off**.

To unlock the MTM800E after powering on, enter the code at the prompt. The MTM800E enters the Home display.

If you fail to enter the correct code, the following message will be displayed:

Incorrect Code Entered – you are prompted to try again. After failing, your MTM800E will be blocked. Please check with your Service Provider how many failed attempts are allowed.

How to unblock the MTM800E

The display shows **Unit Blocked**. You can send an Emergency Call.

To unblock the MTM800E, enter the PUK (Personal Unlocking Key). The PUK is an eight-digit master code to be obtained from your Service Provider.

After entering the PUK successfully, you will be prompted to replace the forgotten code.

At the **New Code** prompt enter the new 4-digit code, and repeat the code to confirm. If the code does not match, you will be prompted to enter it again until the new code message is accepted.

Change Code

From the main menu, select **Security > Change Code**.

NOTE *The default PIN code is 0000.*

At the **Old Code** prompt, enter the 4-digit code. If the old code does not match the entered code at verification, the display prompts you to re-enter the old code.

If the entered code matches the old code, the display prompts you to enter a new 4-digit code and to repeat it for confirmation. If the confirmation code does not match the new code, the display prompts you to re-enter the new code.

When the new code is accepted, the display returns to the Security sub-menu.

Locking/Unlocking the Keypad

To prevent accidental key/button presses:

Press **Menu** (***⏏**) to lock/unlock the keypad.

Service Provider can choose the notification for the Keypad lock and if to lock the **PTT**.



NOTE *When there is an incoming call and the keypad with **PTT** are locked, you can still use the **PTT**, rotary knob, **⏏**, and **⏏**.*

NOTE



The Emergency button is not locked. Entering Emergency Operation, unlocks all keys.

Keypad Lock Notification

When the keypad is locked one of the following instructions is displayed:

- None – no notification is display.
- Notification Only – **Keys Locked** is displayed.
- Notification and Instruction – Keys Locked, Press Menu and * to unlock is displayed.

Automatic Keylock

This feature locks the keypad automatically after not using it for predefined minutes. To turn it on/off highlight **Auto. Lock** and press **Change** then choose the **On/Off**. To change the delay of the key lock highlight **Delay** and press **Change**. Adjust the time by pressing  or  and press **Done**.

Keypad Lock on Startup

User can set the Keylock at the start up of the terminal. To turn it on / off highlight **Start Locked** and press **Change**. Choose **On/Off** and press **Select**.

Air Encryption On/Off

From the main menu, select **Security > Air Encrypt**.

This sub-menu allows you to view air encryption On/Off state.

Call encryption provides service confidentiality between you and the system.

If encryption is on and you receive a clear call (unencrypted), the MTM800E will display a **Call & Data Not Encrypted** message.

NOTE

You cannot manually disable Air Encryption (if fitted) from the menu. This sub-menu only indicates if Air Encryption is enabled at that moment.

NOTE

*The **Air Encryption** feature is only enabled depending on your Service Provider.*

Air Encryption Key Deletion

Please check with your Service Provider whether the terminal is provided with air interface encryption keys.

You can delete the air interface encryption keys from the terminal by entering the following sequence from the keypad:

**** 0 0 # #**

NOTE *It takes a minute for this feature to delete all the encryption keys from the radio. During this time please do not remove the battery.*



CAUTION

Using this feature will disable the terminal, and your Service Provider will need to re-enable the terminal.

NOTE *Deletion should be performed in idle TMO/DMO or Emergency Operation.*

K Validity

From the main menu, select **Security > K Validity**.

K (Key) is a secret key the infrastructure uses to authenticate the MTM800E in the system. It is part of the authentication that provides service confidentiality between your MTM800E and the system.

To verify K validity, press **Select**. The display will show one of the following messages:

- **K is Valid** – the infrastructure can authenticate your MTM800E.
- **K is Invalid** – the infrastructure shall not authenticate your MTM800E. Please call your Service Provider to restore K to your MTM800E.

TMSCK Validity

From the main menu, select **Security > TMSCK Validity**.

SCK (Static Cipher Key) is a secret key the infrastructure uses to encrypt call and data in the system. Air interface encryption provides service confidentiality between your MTM800E and the system. Your MTM800E should be provided with a set of SCKs.

To verify SCK validity for TMO, press **Select**. The display will show one of the following messages:

- **TMSCK is Valid** – your MTM800E can work encrypted in TMO.
- **TMSCK is Invalid** – your MTM800E cannot work encrypted in TMO. Please call your Service Provider to restore SCKs to your MTM800E.

DMSCK Validity

From the main menu, select **Security > DMSCK Validity**.

SCK (Static Cipher Key) is a secret key the infrastructure uses to encrypt call and data in the system. Air interface encryption provides service confidentiality between your MTM800E and the system. Your MTM800E should be provided with a set of SCKs.

To verify SCK validity for DMO, press **Select**. The display will show one of the following messages:

- **DMSCK is Valid** – your MTM800E can work encrypted in DMO.
- **DMSCK is Invalid** – your MTM800E cannot work encrypted in DMO. Please call your Service Provider to restore SCKs to your MTM800E.

DMO SCK

From the main menu, select **Security > DMO SCK**.

Key version is displayed when you select the option.

Air Interface encryption provides service confidentiality between your MTM800E operating in Direct Mode and another terminal or a group of terminals operating in Direct Mode.

You can change the current key, if the key change operation is allowed by your Service Provider.

To change the key, if not in a call, select **Next**. The display will show the following message: **Change to version...**

- Select **Yes** to change the key. **Key version changed** display will appear.
- Select **No** to leave the key. **Key version** display will appear.

Covert Mode

From the main menu, select **Security**
> **Covert Mode**.

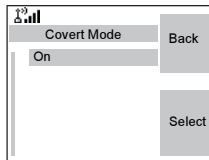

Set Covert Mode to On

Select **On**. All tones are set to off, and the backlight and the LED are disabled immediately. The group audio is routed to the earpiece.

Set Covert Mode to Off

Select **Off**. All settings for tones, backlight and audio are restored. The LED is enabled and the message **Covert Mode Off** is shown.

Setup

From the main menu, select **Setup**.

This sub-menu allows you to change your MTM800E configuration: ring style, set volume, language, data setup, audio, tones, display and time & date.

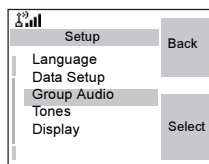

Setting the Ring Style

This sub-menu allows you to set the incoming call ring style. Your MTM800E features nine for **Duplex** and ten for **Simplex** selectable ring styles.

From the main menu, select **Setup** > **Ring Style**.

Upon entry into this sub-menu, the display shows the current ring style used.

Scroll to the desired style and press **Select**. You will hear the new ring style immediately for a few seconds. If necessary, adjust the volume level.

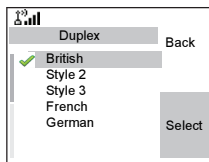

Setting the Volume

This sub-menu allows you to adjust the Simplex, Duplex, Earpiece, Speaker, and Keypad tone volume.

To set the volume:

1. From the main menu, select **Setup** > **Set Volume**.
2. Scroll through the list.
3. Choose the required item, and press **Change**.
4. Adjust the level with the left arrow to decrease and the right to increase the volume. A feedback tone is heard, and a volume level bar is displayed.
5. Press **Back** to exit.

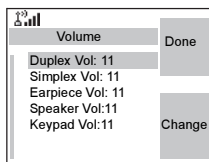

NOTE

If the display shows only one option **Volume**, user can adjust all of the above settings at once. User has the option to change the settings individually when the **Volume Adj. Mode** is set to **Individual**. More information please go to “Setting Volume Adjustment Mode” on page 123..

NOTE

The volumes for the Call-Out messages are not adjustable.

Setting the Display’s Working Language

From the main menu, select **Setup**
> **Language**.

The display shows the current language used. You can customize your MTM800E to operate in English, German, French, Spanish, Dutch, or in a language defined by your Service Provider. The default setting from factory is English.

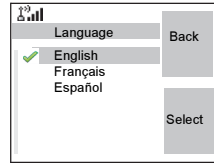

Scroll to the desired language and press **Select**. The display shows the selected language for a few seconds.

Setting Up the Data Function

You can connect the MTM800E to an external device (such as a laptop or desktop PC). The MTM800E will then be capable of transmitting and receiving data from the external device. To connect the MTM800E accessory connector to the external device, use cable FKN4897. The external device must run an application complying with the TETRA standards.

From the main menu, select **Setup**
> **Data Setup**.

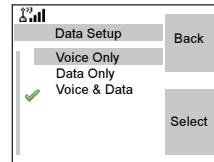

The display shows the current setting:

- 1. Voice Only** – The MTM800E will receive and transmit voice calls only.
- 2. Data Only** – The MTM800E acts as a modem. The MTM800E rejects incoming and outgoing voice calls (except for Emergency Calls), status and text messages.
- 3. Voice & Data** – The MTM800E acts as a modem but voice calls have priority over data calls and will interrupt them.

Scroll to the desired setting and press **Select**.

In Data Only and in Voice & Data, the Data Connected icon is displayed after you have connected the MTM800E to the external device and the MTM800E is ready for data transfer. The Data Transmit/Receive icon is displayed to indicate data is being transferred to/received from the external device.

The MTM800E ends the Ambience Listening (AL) call and the microphone is closed when the MTM800E is in one of the following states:

- Entering the out-of-service area
- Outgoing packet data call setup

To exit **data**, return to **Data Setup** and select **Voice Only**. The MTM800E returns automatically to Voice communication.

NOTE *Data services are available only in TMO. Data Services are blocked in TXI Mode.*

Setting Audio

From the main menu, select **Audio**.

This sub-menu allows you to adjust your MTM800E audio settings.

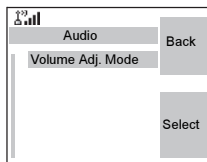

Setting Volume Adjustment Mode

You can set the volume to **Individual** or to **Common**. When it is set to **Individual**, the audio for Duplex, Simplex, Earpiece, Speaker and Keypad can be set per user preferences. When set to **Common**, the audio have one setting for all items.

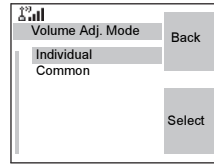

1. From the main menu, select **Setup > Audio > Volume Adj. Mode**.
2. Choose required setting, and press **Select**, or press **Back** to exit.

Setting Tones

From the main menu, select **Setup > Tones**.

This sub-menu allows you to activate/deactivate the MTM800E tones.

For a detailed list of tones, see “Tones” on page 185..

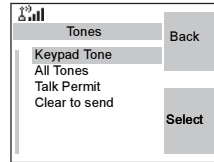

Setting Keypad Tone

To activate/deactivate keypad tone at every key press:

1. From the main menu, select **Setup > Tones > Keypad Tone**.
2. Scroll through the settings (**On/Off**).
3. Choose required setting, and press **Select**, or press **Back** to exit.

Setting All Tones

To activate/deactivate all tones (keypad tone and other activity tones used in your MTM800E):

1. From the main menu, select **Setup > Tones > All Tones**.
2. Scroll through the settings (**On/Off**).
3. Choose required setting, and press **Select**, or press **Back** to exit.

NOTE

When all tones are disabled, your MTM800E switches into covert mode, and all audio is routed to the handset earpiece, instead of the speaker for low audio operation. Remember to disable this feature, when your covert operation is complete, to return your MTM800E to high audio operation.

Setting Talk Permit Tone

There are 3 tone settings:

- **No Tone** (no tone heard upon pressing the **PTT**).
- **Short Tone** (a short tone heard upon pressing the **PTT**).
- **Normal Tone** (the factory-default tone heard upon pressing the **PTT**).

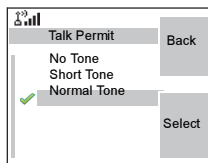

To change your Talk Permit Tone settings:

1. From the main menu, select **Setup > Tones > Talk Permit**.
2. Scroll through the settings.
3. Choose required setting, and press **Select**. Press **Back** to exit.

Setting Clear to Send

The Clear to Send tone indicates to the transmitting terminal that the receiving terminal is ready to accept the transmission.

To activate/deactivate the Clear to Send tone:

1. From the main menu, select **Setup > Tones > Clear to send**.
2. Choose required setting, and press **Select**. Press **Back** to exit.

Setting Periodic Alert

Periodic alert indicates the missed calls, the unread messages and low battery. For each indication the unread message tone is played with the amber LED color.

To activate/deactivate the Periodic Tone:

1. From the main menu, select **Setup > Tones > Periodic Alert > Alert**.
2. Choose required setting, and press **Select**. Press **Back** to exit.

To set the period between tone indications.

1. From the main menu, select **Setup > Tones > Periodic Alert > Period**.
2. Choose required setting, and press **Select**. Press **Back** to exit.

Setting D-PTT Tones

To activate/deactivate the D-PTT Tone:

1. From the main menu, select **Setup > Tones > D-PTT Tones > D-PTT Mode**.
2. Choose required setting, and press **Select**. Press **Back** to exit.

To choose the tone:

1. From the main menu, select **Setup > Tones > D-PTT Tones > Tone Style**.
2. Choose the tone between three options: **Single**, **Double** or **Triple**. Please go to “Double PTT - Single Tone” on page 187. to view the specification of the tones.

Time & Date Features

The Time & Date menu controls the displayed time and date.
From the main menu, select **Setup > Time & Date**.

Time & Date Display Settings

From the main menu, select **Setup > Time & Date > Display**.

The display shows the current setting:

- 1. Time & Date** – The MTM800E displays time and date.
- 2. Time only** – The MTM800E displays time only. **Format Date** sub-menu is disabled.
- 3. Date Only** – The MTM800E displays date only. **Format Time** sub-menu is disabled.
- 4. Off** – The MTM800E does not display time nor date. **Format** menu is disabled.

Scroll to the desired setting and press **Select**. Press **Back** to exit.

Setting Time Format

To change displayed time format between 24-hour scale and 12-hour scale:

1. From the main menu, select **Setup > Time & Date > Format > Format Time**.
2. Scroll through the settings.
3. Choose required setting, and press **Select**. Press **Back** to exit.

Setting Date Format

To change displayed date format between DD/MM/YY, MM/DD/YY, DD-MON-YY and YY/MM/DD:

1. From the main menu, select **Setup > Time & Date > Format > Format Date**.
2. Scroll through the settings.
3. Choose required setting, and press **Select**. Press **Back** to exit.

NOTE

Time and date are synchronized by the infrastructure. When not within the infrastructure signal range you can set the values manually.

Setting Time

To set time:

1. From the main menu, select **Setup > Time & Date > Set > Set Time**.
2. Enter time using navigation key and/or numeric keypad, and press **Done**. Press **Cancel** to exit.

Setting Date

To set date:

1. From the main menu, select **Setup > Time & Date > Set > Set Date**.
2. Enter time using navigation key and/or numeric keypad, and press **Done**. Press **Cancel** to exit.

Setting Offset

To set local time offset:

1. From the main menu, select **Setup > Time & Date > Set > Time Offset**.
2. Enter time offset using navigation key, and press **Done**. Press **Cancel** to exit.

NOTE

You can adjust the offset value, with 15 minute steps, up to 14 hours ahead or behind.

System Update

You can pick how you would like to update the time and the date displayed on the radio:

1. To turn off the automatic update from the infrastructure **Setup > Time & Date > System Update > Off**. All the broadcasted informations are ignored. The terminal uses internal time and offset.
2. To turn on the automatic update only for time **Setup > Time & Date > System Update > Time Only**. The time displayed is calculated from the offset programmed by your Service Provider added or subtracted from the network time.
3. To turn on the automatic update **Setup > Time & Date > System Update > Time & Offset**. Time and offset are updated after receiving broadcasted information.

Display Features

The display menu controls how the display appears.

From the main menu, select **Setup > Display**:

- **Text Size** – sets size of text on the display.
- **Screen Saver** – covers the MTM800E display after the MTM800E stays idle for a pre-programmed period of time (if configured by your Service Provider).
- **Backlight** – a backlight lights the display and keypad when you make or receive a call, or press keys or buttons. Backlight can be set to Automatic or Disabled.
- **Wallpaper** – changes the wallpaper that appears on the idle screen.

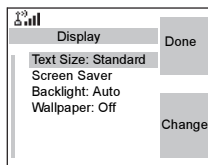

Setting the Text Size

1. From the main menu, select **Setup > Display > Text Size**.
2. Press **Change**. Select **Standard** or **Zoom** to see the text on the display in two sizes.

Setting the Screen Saver

1. From the main menu, select **Setup > Display > Screen Saver**.
2. Press **Change**. Press **Change** again and select the screen saver setting: **Automatic** or **Disabled**.
3. Scroll to **Text**. Press **Change**. Type/edit the screen saver text using the keypad. (For details on text editor use, see “Writing Text” on page 167.).
4. Press **Select** to exit.

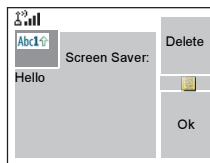



NOTE *The menu options will display the Screen Saver if your Service Provider pre-programmed this feature.*

Setting the Backlight

Your MTM800E has 3 backlight settings:

Manual - By pressing the **Backlight Key**  you can toggle through 5 intensity profiles. See the table below.

NOTE *Setting the backlight intensity level by pressing the **Dimmer button**  will also change the LED, keypad backlight, and Emergency button backlight intensity.*

Semi-Auto - Per default the backlights are switched off. You can switch the backlights on by pressing the **Dimmer button** . After a few seconds (configured by your Service Provider) the backlights switch off automatically.

Auto - Per default the backlights are switched off. The backlight switches on when **any key** is pressed, or another activity - like incoming call - occurs. After a few seconds (configured by your Service Provider) the backlight switches off automatically.

Profile	Display backlight	Keypad backlight	Status LED	Emergency button backlight
1. Intensity High	100%	on	100%	100%
2. Intensity Below High	75%	on	75%	100%
3. Intensity Above Low	50%	on	50%	100%
4. Intensity Low	25%	on	25%	50%
5. Intensity Off	0%	on	15%	50%

Note: The intensity level can be changed by your Service Provider.

To change your backlight settings:

1. From the main menu, select **Setup > Display > Backlight**.
2. Press **Change**.
3. Select required setting.
4. Press **Done** to exit.

Setting the Wallpaper

1. From the main menu, select **Setup > Display > Wallpaper**.
2. Press **Change**.
3. Select required setting (**On/Off**).
4. Press **Done** to exit.

Entering More...

From the main menu, select **More...** This sub-menu Contains more customisable menu items.

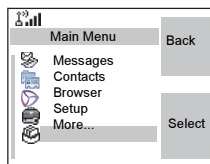

Entering Group Setup

From the main menu, select **More... > Group Setup**. This sub-menu allows you to set the Scan and My Groups features.

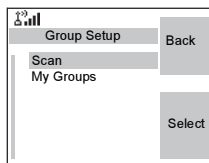

Entering Scan

From the main menu, select **More... > Group Setup > Scan**.

This sub-menu allows you to activate/deactivate scanning, view the active scan list, and edit the scan lists.

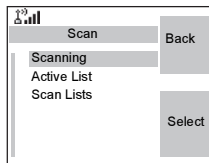

NOTE *It is not possible to enable or disable group scanning in TXI Mode.*

Setting Group Scanning

This sub-menu allows you to activate/deactivate the scanning of a list of pre-defined groups programmed in the MTM800E. The MTM800E will join any group call as long as this group is defined in the scan list and scan is turned on.

From the main menu, select **More... > Group Setup > Scan > Scanning**.

After completing the settings, the display returns to the Scan sub-menu.

Set Scanning to On

Scanning is **Off**. Select **On**. A message may indicate that all scan lists are empty. Select **Scan Lists** to fill the scan list(s).

The display shows the following state:

Then, the display shows (for example) the **Scanning Scan List 1** message.

The terminal will then try to attach to this list.

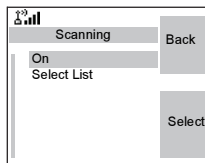

Set Scanning to Off

Scanning is on. Select **Off**. The display shows the following state:

Then, the display shows the **Scanning is Off** message.

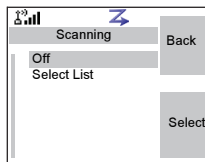

Selecting a List with Scanning On

1. Select **Select List**.
2. To select a list other than the highlighted one, scroll and press **Select**. The display shows (for example) the **Scanning Scan List 1** message. The terminal will then try to attach to this list.

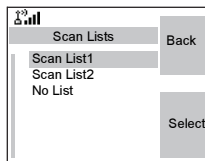

Selecting a List with Scanning Off

1. Select **Select List**.
2. To select a list other than the highlighted one, scroll and press **Select**. The display shows (for example) the **Scan List 1 Selected** message.

The Network List

Your terminal can scan (and attach) to a list belonging to another infrastructure than the Dimetra infrastructure:

- Upon pressing **Select**, if the Network List is selected, only this list will attach. If a user list is selected, then both the Network List and the user list will be attached.

- In some cases part of the groups in the scan list could be invalid for specific sites. In this case, when the terminal tries attachment to the list, the infrastructure might partially reject attachments. The terminal's display shows: "List partially attached".
- When the Network List is empty, it will be displayed as **No List**. Selecting **No List** will display the message **No Selected Scan List**.

Viewing the Active Scan List

This sub-menu allows you to view the active scan list (Scan List 1 in this example).

1. From the main menu, select **More... > Group Setup > Scan > Active List**. Press **View**.

The display will show one of the following states:

- There is a selected, inactive scan list (**Scan List 1 is Not Active**). Scanning is off.
- Scanning is off and the Network List is selected (**Network List Not Active**).
- There is a selected, active scan list. Scanning is on.

Then, the display will show the Scan Lists sub-menu.

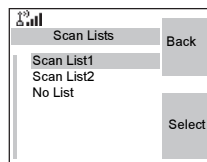

2. Scroll to the required list and press **View** to see the groups that belong to the list.
3. Scroll to the required group and press **View** to view the group status (attached or not attached) and priority (if pre-programmed).
4. Press **Back** to return to the previous display. Then, if required, press **Menu**. You can select to **delete** the group from the scan list or **change** its priority.

NOTE *If the Network List is empty, it will not be displayed.*

Editing Scan Lists

1. From the main menu, select **More... > Group Setup > Scan > Scan Lists**.
2. Scroll to the required scan list. Press **View** to see the groups used in the scan list. Press **Back** to return to the previous display.
3. To edit/view the contents of a scan list, press **Menu**.
4. In the List Optns sub-menu, scroll to the required option and press **Select**.

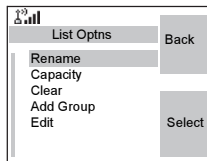
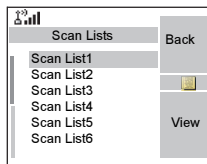

NOTE *The options below **cannot** be used for the Network List. If the Network List is empty, it will not be displayed.*

- **Rename** the active scan list. (For details on text editor use, see "Writing Text" on page 167.). Enter a new name (alias) and press **Ok**. The display shows the new setting.
- Check the **capacity** of the active scan list (number of groups stored in the list).
- To **Clear** all groups from the selected scan list, press **Yes**. You will be prompted to remove all groups from the selected scan list.
- **Add** a group to the selected scan list. Every added group (including a favourite group) comes with its folder, its name or number, and its priority (if pre-programmed).
 - > To select a folder, scroll through the folder list. The list does not show folders whose groups are fully used in the selected scan list. Press **Ok** to select a folder.
 - > To select a group, scroll through the group list within the selected folder. The list shows groups that are not in the selected scan list. Press **Ok**.

- > To set a priority to a group, scroll through the priority list: high, medium, or low.
 A call from a high priority group will interrupt an on-going call with a medium and low priority.
 A call from a medium priority group will interrupt an on-going call with a low priority.
 A call from a low priority group will not interrupt any on-going call.
- **Edit** the scan list groups.
 - > Scroll to the group you wish to remove from the selected scan list, press **Menu** and press **Delete**. You will be prompted to remove the selected group. After a few seconds, the display shows the updated scan list.
 - > To change the group priority, press **Priority**. Scroll to the selected priority and press **Select**.

My Groups (TMO/DMO)

This sub-menu allows you to select/edit your favorite group list.

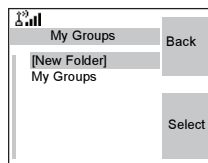

Adding a Group

1. From the main menu, select **More... > Group Setup > My Groups > <FolderName> > [New Group]**.
2. Select a group by folder search ("**TMO/DMO by Folder**"). Select the folder and select the group. The group is added to the "My Groups" folder. *OR*, select a group by alphabetic search ("**TMO/DMO by abc**"). You can enter up to 12 letters of the group's name.

Deleting a Group

1. From the main menu, select **More... > Group Setup > My Groups > <FolderName>**.
2. Highlight talkgroup name that you want to delete and select **Delete**.
3. Select **Yes** to confirm.

Deleting All Groups

1. From the main menu, select **More... > Group Setup > My Groups > <FolderName>**.
2. Press **Menu**. Select **Delete All**.
3. Select **Yes** to confirm.

NOTE This option is available only if the Service Provider enables it.

Adding Favorite Folder

1. Press Menu and select **More... > Group Setup > My Groups**.
2. Select **[New Folder]**.
3. After entering the name of the folder press **Ok** to confirm.

Renaming Favorite Folder

1. Press Menu and select **More... > Group Setup > My Groups**.
2. Highlight a group folder name and press Menu.
3. Select **Rename Folder**.
4. After editing the name of the folder press **Ok** to confirm.

Deleting Favorite Folder

1. Press Menu and select **More... > Group Setup > My Groups**.
2. Highlight a group folder name and press Menu.
3. Select **Delete Folder**.
4. Press **Yes** to confirm.

NOTE *You cannot delete the last favorite folder.*

Viewing/Modifying Personal Information

Use this feature to view your own private or phone number at any time.

1. From the main menu, select **More... > My Info**.
2. Select **My Private Number**, **My Phone Number** or **Radio Info**.

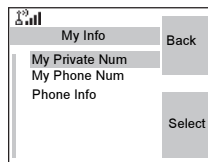

The displayed private number cannot be modified.

To modify the displayed phone number, press **Edit**.

Edit the number and select **Ok** to confirm. The new phone number does not modify the MTM800E number in the system.

Radio Info stores information about:

- Manufacturer
- Product Type
- ISSI
- TEI
- Serial Number
- OPTA (information available only if the BSI feature is enabled).

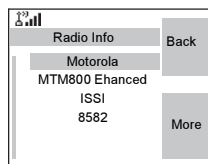

NOTE *This feature is available only if the Service Provider enables it.*

Recent Calls

You can view the history of all calls:

- **Dialed Calls**
- **Received Calls** – calls you answered
- **Missed Calls** – calls received but not answered, or rejected by the MTM800E.

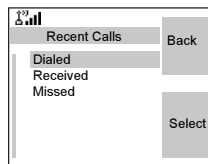

Each list of calls may contain up to 50 numbers, the more recent call being at the top of the list.

If the number of a recent call is stored in the contact list, the name associated with the number appears in the recent calls list.

An icon appears beside the name or number, indicating the contact type of the number used in the call. See “Contacts” on page 110..

Old calls remain in your recent calls list until you delete them or until they reach the end of the list.

A number dialed more than once, will appear only once in the list.

Upon receiving a missed call notification, the MTM800E will display the missed calls prompt.

When a call is received during an active call, the number is written to the missed calls list. This missed calls prompt will be invoked automatically at the end of the call. Press **Ok** to display the missed calls list.

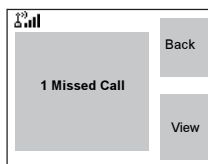

NOTE *If your Service Provider has restricted access to the Contacts list, it might not be possible to dial up a number which is not in the Contacts list.*

Viewing Recent Calls

1. From the main menu, select **More... > Recent Calls**.
2. Scroll to the desired list (dialed, received, or missed) and press **Select**.

To get more information on a recent call:

From the recent calls list, select the call you want information on. Press **View** or if the number is not in your contact list press **Menu** and select **View**. This displays information such as the name associated with the call, the number of the call, call time and the call duration.

NOTE *Call time information are only available if the time and date is set in the radio. Call duration is not available in the missed calls list.*

Storing Recent Calls to Contacts

1. From the recent calls list, scroll to the number you want to store.
2. Press **Store**.

NOTE *If **Store** is not assigned to the left soft key, the number is already stored in Contacts.*

3. To store the number as a new entry, select **[New Contact]**. Or, to store the number to an existing entry, select the entry by selecting **View** then **Edit**.
4. With the contact type field highlighted, scroll left or right to display the contact type you want to assign the number. For information on contact types, see page 110.
5. If you wish to add more information to the entry, see page 112.
6. Press **Done**.

Deleting Recent Calls

1. From the recent calls list, scroll to the call you want to delete.
2. Press **Menu**. Enter Dialed Calls. Select **Delete**. Press **Yes** to confirm.

To delete all calls:

1. From the recent calls list, press **Menu**.
2. Select **Delete All**. Press **Yes** to confirm.

Calling from Recent Calls

1. You can make a Phone, PABX, or Private Call from the entry, depending on the entry you are selecting in the list.

NOTE *A call that was missed or received without a calling number, will be stored in the list as “unknown”. You cannot start a call to such a number.*

2. After completing the call, the MTM800E will exit the received/missed/dialed list.

NOTE *From the Home display press  to access the list of the last dialed calls.*

Shortcuts

Use shortcuts to access frequently-used menu items.

Help on Creating a Menu Shortcut

1. From the main menu, select **More... > Shortcuts**.
2. Select **[New Entry]** and read the first page of instructions. Press **More** to read the second page.
3. Press **Done** to exit help.

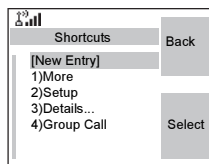

Creating Menu Shortcut

For example, let's create a shortcut to the All Tones options.

1. From the main menu, select **Menu > Setup > Tones**, then highlight **All Tones**.
2. Press and hold the **Menu** button until a confirmation screen appears. Press **Yes** to confirm.
3. The first free position is assigned as a shortcut key. A confirmation screen appears. Press **Done** to confirm.

Viewing the Menu Shortcut List

1. Press **Menu**.
2. Select **More... > Shortcuts**. The display shows the shortcut list.

NOTE *If the Service Provider configures the shortcuts, [New Entry] will not be displayed.*

Editing Shortcuts

1. From the main menu, select **More... > Shortcuts**.
2. Scroll to the shortcut you wish to edit.

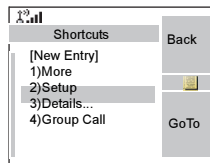

NOTE *To modify a menu setting or create a new shortcut from this step, highlight the menu option and select **GoTo**. Otherwise, go to Step 3.*

3. Press **Menu** and select **Edit**.
4. Type a number (1-20) that you want to assign to this shortcut. Press **Ok** to confirm. You can delete typed number and press **Cancel** to quit editing.
If the number is already assigned as a shortcut for another option, you will be asked to replace the current shortcut number with a newly created one.

Deleting Shortcuts

1. From the main menu, select **More... > Shortcuts**.
2. Scroll to the shortcut you wish to delete.
3. Press **Menu** and select **Delete**. Press **Yes** to delete a shortcut. Press **No** to cancel.

Deleting All Shortcuts

1. From the main menu, select **More... > Shortcuts**.
2. Scroll down to the shortcuts.
3. Press **Menu** and select **Delete All**. Press **Yes** to delete a shortcuts. Press **No** to cancel.

Shortcut Display Messages

The display might show one the following messages for a few seconds:

- **Shortcuts Full:** the shortcut list is full.
Press **Yes** to confirm that you wish to assign a shortcut to the option. Enter a new key number. If the number is already assigned as a shortcut for another option, you will be asked to replace the current shortcut number with a newly created one.
- **Shortcut not Allowed for this Item**
- **Invalid Shortcut Position:** enter a new number from the number entry screen.

Menu Shortcut Use

From the Home display, press **Menu** and the numeric key(s) assigned to the shortcut.

RUI

It gives more flexibility to the users to pick any radio and log on with it and have a full access to the service. All the services are forwarded to the radio that you are logged on to.

NOTE *If the Service Provider disables this feature, full service is granted without logging.*

- NOTE**
- *If you have logged on to another terminal, the Store & Forward message report may not be valid for this terminal. Sending explicit message confirming reception is recommended.*
 - *This is recommended to delete the messages from the **Outbox** before you log off.*

Radio States

- Full Service – user Log On/Book On was successful
Radio has full functionality.
- Limited Service – user not logged on. Specified by the service provider.

- Pseudo Log On

Radio has full functionality available (depending on the service provider) except some services like forwarding calls. The little icon (as displayed) indicates when the radio is in pseudo-log-on mode.

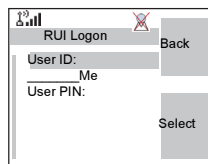

Log On

From the idle screen you need to press **Menu > Setup > RUI > Log On**

1. Selecting User ID.

- to edit User ID go down to second line and press **Menu**.

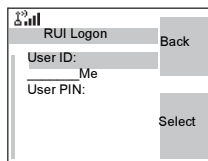

- to enter New User ID press **Select**
Type your User ID and press **OK**.

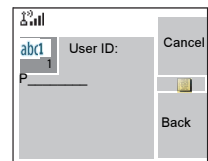
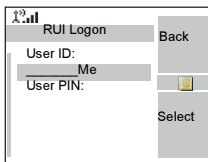

- to choose your User ID from the list highlight the correct one and press **Select**

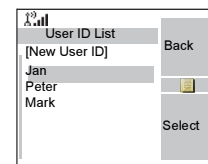

NOTE

You can press **Menu** anytime to view the detailed list (useful for the long User ID's that are not fully displayed). Press **Menu** again to go back to the previous list.

2. Type your User PIN

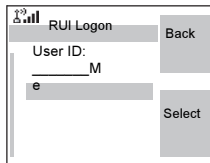

When the User PIN is highlighted press **Select** and type your User PIN on the next screen then press **OK**.

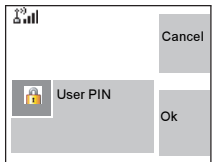

3. Logging

From this point the request to logon is sent. You can stop the logging process by pressing **Cancel**. When the logging process ends the display is changed to idle screen.

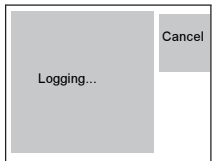

NOTE *Color blue of the display is when the user is in full service mode. In other case the greyscale screen is displayed.*

User ID List

The user can check who was using this radio before, by going to **Menu > More > RUI > Log on > User ID**. The chronological list is displayed under the **[New User ID]**.

Log Off

You can change the state that you are logged on by pressing **Menu > Setup > RUI > Log Off** from the idle screen. The radio prompts to accept log off state or to deny it (if you selected it by mistake).

Book On

Any radio (if the Book On is enabled by the Service Provider) can be assigned by the service provider to one person. You are going to see only screen with your login and the full service is granted from this point.

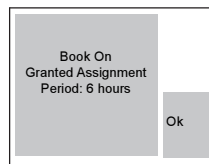

Book On Setup

Menu > Setup > Book on Setup

You have two options:

- Book on Accept – radio is going to accept all the book on requests.
- Book on Reject – radio is going to reject all the requests from the Service Provider and user is not going to see any notification.

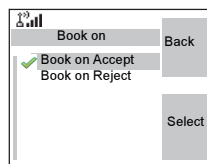

NOTE When the Book on feature is disabled by the Service Provider user is not able to change Book on setup.

Force Off

The Service Provider can log off the user. Radio informs the user about the result and the reason of Force Off state.

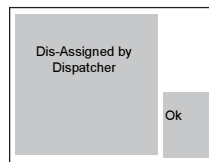

Networks

Entering the Networks Sub-menu

From the main menu, select **More... > Networks**.

This sub-menu allows you to select the network your MTM800E registers to, and what mode it operates on.

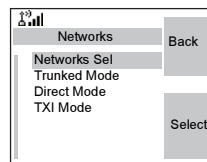

Selecting Your Network

This sub-menu allows you to select the network your MTM800E will be registered to.

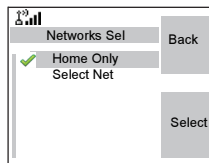

Selecting Home Only Network Registration

From the main menu, select **More... > Networks > Networks Sel > Home Only**.

Selecting this sub-menu causes your MTM800E to recognise the first network on the allowed network list only and to register to it.

Using the Select Net Registration

If configured by your Service Provider, this sub-menu allows you to select manually the network from the allowed network list you want your MTM800E to be registered to.

1. From the main menu, select **More... > Networks > Networks Sel > Select Net**.
2. The list of the allowed networks is displayed. Scroll to the desired network.

A network may have an alias. Press **Menu** to view the network ID. Then press **Select**.

3. Return to the Home display. The display shows the network ID or alias.

NOTE

It is up to your Service Provider to ensure your own MTM800E identity is allowed to register on other networks in your list. Some groups may not be available on other networks.

Selecting Trunked Mode

This sub-menu allows you to select the mode your MTM800E will be operating on.

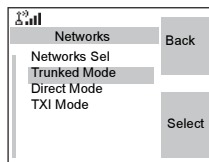

To set up your operating mode:

1. From the main menu, select **More... > Network > Trunked Mode**.
2. The MTM800E switches to Trunked Mode.

NOTE *It is not possible to switch from Direct Mode to Trunked Mode, if the MTM800E is in Transmit Inhibit Mode.*

Selecting Direct Mode

This sub-menu allows you to select the mode your MTM800E will be operating on.

To set up your operating mode:

1. From the main menu, select **More... > Networks > Direct Mode**.
2. The MTM800E switches to Direct Mode.

NOTE *It is not possible to switch from Direct Mode to Trunked Mode, if the MTM800E is in Transmit Inhibit Mode.*

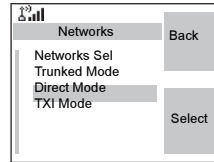

Setting Transmit Inhibit (TXI) Mode

This mode should always be set before entering areas where transmission is prohibited, e.g. in hospitals or in potentially explosive areas.

To activate the TXI Mode:

1. From the main menu, select **More... > Networks > TXI Mode**.
2. Select **Activate**.

The MTM800E will sound the “Transmit Inhibit” tone. The display shows **TXI Mode** in the first row, and the solid amber LED indicates the TXI Mode.

NOTE *All menu items which cause transmitting are blocked in TXI Mode. It is not possible to change the group.*

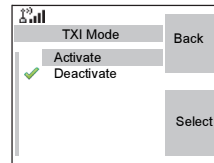

To deactivate the TXI Mode, e.g. after you have left the area where transmission is prohibited:

1. From the main menu, select **More... > Networks > TXI Mode**.
2. Select **Deactivate**.

The MTM800E sounds the “Transmit Inhibit” tone and exits TXI.

Location

Refer to “GPS Location Service” on page 99. for details.

Packet Data

This menu item allows to display statistical values related to a packet data connection. If Multi Slot Packet Data Service is enabled by your Service Provider the screens present information about

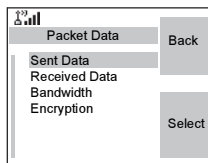

- Amount of sent data,
- Amount of received data,
- Bandwidth of the data session
- Data encryption status.

NOTE

Data services are only available in TMO. The data option must be set to Voice&Data or Data Only. (Refer to “Setting Up the Data Function” on page 121.).

Viewing Sent Data Statistics

1. Select **Sent Data** in the Packet Data sub-menu.

The number of KBytes sent since current packet data activation is displayed. Additionally the throughput is shown:

9 kbps (e.g.) – active packet data session.

N.A. – standby packet data session.

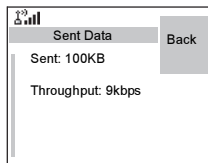

Viewing Received Data Statistics

1. Select **Received Data** in the Packet Data sub-menu.
2. The number of KBytes received since current packet data activation is displayed.

Additionally the throughput is shown:

9 kbps (e.g.) – active packet data session.

N.A. – standby packet data session.

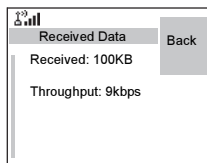

Viewing Bandwidth Status

The bandwidth percentage represents the number of allocated time slots (“channels”) during the data session.

1. Select **Bandwidth** in the Packet Data sub-menu.
2. The bandwidth percentage is shown **75%** (e.g.) – active packet data session,

N.A. – standby packet data session.

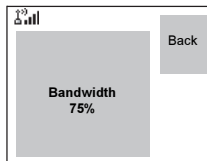

NOTE

Your Service Provider has set the maximal number of time slots to allocate to 1, 2, 3, or 4. The bandwidth percentage refers to the possible number of slots (1, 2, 3, or 4) as 100%.

Example:

50% is displayed, if 2 of 4 possible slots are allocated.

100% is displayed, if 4 of 4 possible slots are allocated.

100% is displayed, if 1 of 1 possible slot is allocated.

Viewing Encryption Status

1. In the Packet Data sub-menu select **Encryption**.
2. The encryption state of the ongoing packet data session is displayed:
 - **Encrypted**
 - **Not Encrypted** (clear)

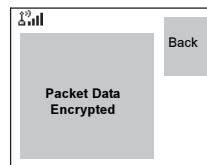

Messages

General

The messaging feature lets you:

- Send text messages (free text or according to user defined or predefined templates).
- Send status messages.
- Receive messages.

A status is a number corresponding to a pre-programmed message in a list your group recognises. A text message is a text containing up to 1000 characters. There are two places where you can find text messages:

- Inbox - stores all incoming messages.

Outbox - stores all outgoing messages.

NOTE *If configured by your Service Provider it is only possible to send a message to a private number that is stored in the Contacts list.*

Sending a Text Message

- NOTE**
- *It is not possible to send a status or text message in TXI Mode.*
 - *It is not possible to send a status or text message during a call in DMO.*

You can send new messages, send messages based on user defined templates or send messages based on predefined templates.

The predefined templates are programmed into your MTM800E by your Service Provider. The user defined templates can be Inbox messages or new Outbox messages that you choose to store in your MTM800E memory. User defined messages may also be programmed into your MTM800E.

You are allowed to edit your messages before sending them. You can send a message when the terminal is idle or during a Group/Emergency/Broadcast Call (if configured).

If configured, a message will alert you of an incoming Group/Emergency/Broadcast call, of your joining it, or of its end.

NOTE

In DMO text messages are sent on the frequency of the current talkgroup. Make sure you select the desired talkgroup before sending a message. For selecting group details see “Selecting a Group” on page 36.

Sending a text message during a Group Call (if configured)

Press . One of the following might occur:

- The call started before message editing began. The terminal will leave the call and send the message. If the call is still active, the terminal will re-join it.
- The call started after message editing began. The terminal will leave the call and send the message. The terminal will return to the edit screen.
- The call started before or after message editing began. The terminal will send the message while staying in the call.

Sending a text message during Emergency/Broadcast Call (if configured)

Press . One of the following might occur:

- The call started before message editing began. The terminal will leave the call and send the message. The terminal will return to the edit screen.
- The call started after message editing began. The terminal will send the message while staying in the call.

Entering the Messages Sub-menu

From the main menu, select **Messages**.

The sub-menu allows you read text messages, send text messages, and send status messages.

Scroll to your selection and press **Select** to access the next display.

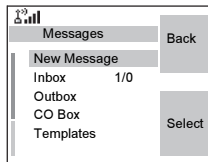

NOTE Your MTM800E can receive calls while in the Messages sub-menu.

New Message

Creating a Message

1. From the main menu, select **Messages > New Message**. An empty screen will open.

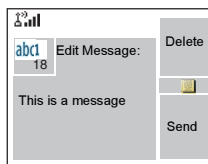

2. Type/edit your message using the keypad. (For details on text editor use, see "Writing Text" on page 167).

Press **Menu**. Select **Store** to add your message to the template list (name of the template can be defined by the user).

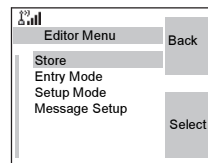

Sending the Message

1. Press **Send**.

- If set up by your Service Provider you have the option to send the message to a private, phone number or a talkgroup.
- Otherwise select the mail recipient of your choice from the contact list or enter the address directly.

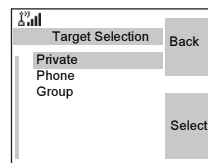

2. Press **Send** or **PTT** or  to send the message.

The display will show one of the following delivery reports:

- **Message Delivered** – to indicate that the message was successfully sent and received.
- **Message Failed** – the message was not received.

Sending Store & Forward Message

After typing the message press **Menu**. Select **Message Setup** and select one of the options. First is to send the text message to the online user. Second option is to send the Store & Forward message. More about “Store & Forward” on page 163.

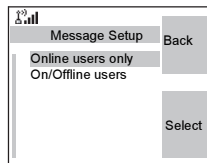

After sending the message, your MTM800E will return to the templates list or to the message editor screen.





NOTE *It is recommended to wait for the message acknowledge before sending a new message.*

Using the Inbox

The inbox list contains new or old incoming text messages and can contain 100 messages.

Inbox Icons

The following icons indicate the status of messages in the Inbox.

Inbox Icon	Description
	Unread (New) Message Indicates that you have not read the message yet.
	Read (Old) Message Indicates that you have read the message.
	Sender Information in Message View Indicates sender information (name or number).
	Time and Date Stamp in Message View Indicates the time and date of message arrival.
	Delivery Status Received Indicates delivery status for Store & Forward messages.

Entering the Inbox

From the main menu, select **Messages** > **Inbox**.

The status (if any) of the list is displayed for a few seconds:

- **No New or Old Messages** – the screen returns to the previous display within a few seconds.
- **Inbox info Inbox Full**. Press **Ok** to confirm.

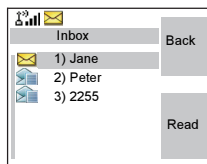

Reading a Message in the Inbox

1. Scroll to the message.
2. Press **Read**.

New Message Received

If you press **Back**, you dismiss the message. You can access the message later from the inbox.

1. Select **Read** to read the entire message. Reading a new text message changes its state from New to Old. The read message is kept in the Inbox.
2. The display shows the incoming message number, sender, and up to 4 lines of the text message.

NOTE

- For message alert, see settings in the Tones menu option (page 123).
- If your service provider has enabled the PTT Callback feature, then pressing PTT will initiate a call to the message originator. Otherwise, PTT will be directed to the currently selected talkgroup.



NOTE

You will hear the "New Mail Received" alert tone when a new message is received while your MTM800E is engaged in a call (if configured by your Service Provider).

Handling Messages

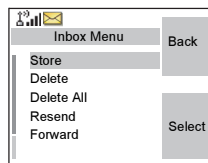
When in the inbox or after reading the message, press **Menu** and select one of the following options:



- Select **Store** and press **Select** to store the message as a template in the template list.
- Select **Delete** and press **Yes** to delete the message. When the display shows “**Deleted: Message n**”, the current message is deleted from the Inbox. Select **Delete All** and press **Yes** to delete all the messages. When the display shows “**Deleted: All Messages**”, all the messages are deleted from the Inbox. The display shows **Messages** sub-menu.
- Select **Reply**. This invokes the edit screen. The old message body serves as the default message and the message originator is the destination. When you are done with editing/adding text press **Send**, **PTT** or , to send the message.
- Select **Forward**. This invokes the edit screen. The old message body serves as the default message. Enter the recipient's number and press **Send**, **PTT** or , to send.
- Select **Refresh** to re-order the inbox list and see new messages (if any).

Press **Back** to return to the previous display.

NOTE *Radio notifies you when the message is too long.*

Calling a Number in a Message

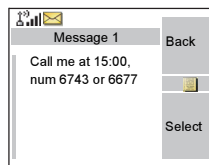

You can return a voice call to the sender of a message or to any number that is embedded in the message text. Your Service Provider should configure this feature.



1. In the inbox list, highlight a message.

OR

read a message containing number(s).

2. Press **PTT** or .
3. The display lists the numbers (including the sender's number).
4. To call, scroll to your selection and press **PTT** or . To store, scroll to your selection and select **Store** and choose existing contact or create a new one (for details on how to create a contact, see "Creating a Contact" on page 109).
5. Press **CType** to select the type of call (Private, Phone, or PABX). Then press **PTT** or .

If necessary, save the entries in the contact list.

NOTE *If configured by your Service Provider it is not possible to call back to a number that is not in the Contacts List.*

Outbox

All sent messages are stored in Outbox. To go to Outbox press **Menu > Messages > Outbox**.

Submenu of the Outbox includes:

- Select **Store** and press **Select** to store the message as a template in the template list.

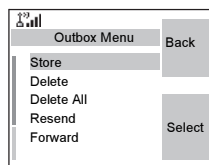

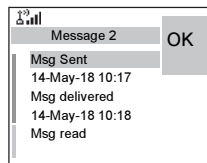

- Select **Delete** and press **Yes** to delete the message. When the display shows “**Deleted: Message n**”, the current message is deleted from the Inbox. Select **Delete All** and press **Yes** to delete all the messages. When the display shows “**Deleted: All Messages**”, all the messages are deleted from the Outbox. The display shows the **Messages** sub-menu.
- Select **Resend** to edit the message and send it to the same participants.
- Select **Forward**. This invokes the edit screen. The old message body serves as the default message. Enter the recipient’s number and press **Send, PTT** or , to send.
- Select **Refresh** to re-order the outbox list and see new messages (if any).
- **Delivery Status** (as displayed).

Shows the date and the time of the message when it was Sent, Delivered, Read, Expired was not delivered, Expired was not read, Failed unknown. Every time the status is changing you are going to receive new message regarding it.



All the messages are described by three icons:

Outbox Icon	Description
	Delivery in Progress
	Delivery Accomplished
	Delivery Failed

Delivery report is saved in Inbox and in the associated message in Outbox. However it is deleted from Inbox after viewing it.

User Defined Templates

The user defined mail templates are received, new, sent or programmed messages that are stored in the templates list and may be used for sending messages.

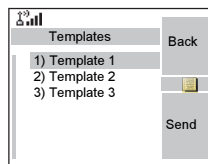

1. From the main menu, select **Messages > Templates**. The first template in the template list is displayed.

NOTE *It is possible that the templates have user defined title.*

2. In the templates list, scroll to the template you want to use. Press **Menu** and select one of the following options:

- **View** to view the message in the template
 - **Edit Text** to edit the message in the template for your needs. (For details on text editor use, see “Writing Text” on page 167). Press **Menu** to enter the **Editor Menu**. Select **Store** to save the edited template as a new one. Default name is given (Template 1, Template 2, ...). Select **Save Changes** to save edited template.
 - **Edit Name** to edit the name of the template that is stored. After editing, select **Ok** to save the name. **Delete** and press **Yes** to delete the template. When the display shows “**Deleted: Template n**”, the current template is deleted from the Inbox. The display shows the next template (if any) or the templates list.
 - **Delete** and press **Yes** to delete the template. When the display shows “**Deleted: Template n**”, the current template is deleted from the Inbox. The display shows the next template (if any) or the templates list.
3. Send the template. See “Sending the Message” on page 153.

Predefined Templates

Predefined mail templates are templates that are programmed into your MTM800E by your Service Provider. You are allowed to perform limited edit operations of the predefined template and to send it, but you will not be able to store the edited template or erase it from the predefined template list.

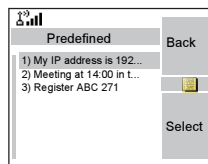

1. From the main menu, select **Messages > Predefined**. The first template in the predefined template list is displayed (if no predefined template exist, the message **No Predefined** will be displayed).
2. Scroll through the list and select the required template. You can also search the template by the name. Use the keypad to enter up to 12 characters.

Press **Menu** to enter the Predefined Menu and select one of the following options:

- **View** to view the message in the template
- **Edit** (In the example, a registration message is displayed)

Editing a Predefined Template

Check with your Service Provider for the types of predefined templates in your terminal.

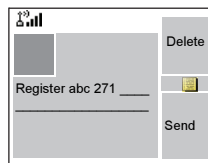

There are three types of predefined templates:

- **Alphanumeric** – enter characters and digits
- **Numeric** – enter digits
- **Mixed** – enter digits, *, and #

The cursor is located after the last character. To move the cursor backward, press . You can only enter as many characters as it was originally in the template.

After editing a template, you can send it.

Sending a Predefined Template

NOTE A predefined message address is also defined by your Service Provider during programming and cannot be changed.

1. Press **Send**, **PTT**, or , or the relevant one-touch numeric key to send the message.
2. The display will show one of the following delivery reports:
 - **Message Delivered** – to indicate that the message was successfully sent and received.
 - **Message Failed** – the message was not received.
3. After sending the message, your MTM800E will return to the predefined template list or to the message editor screen.

NOTE It is recommended to wait for the message acknowledge before sending a new message.

Sending a Status Message to a Group

1. Switch to the desired talkgroup, to which you want to send a status message.
2. From the main menu, select **Messages > Send Status**.
3. In this example, Lunch is the last sent status. If you wish to send a different status, scroll to your selection in the list of pre-programmed statuses, or enter 5 digit status number and skip the next step.
4. Press **Menu** and select **View** to view the status message. Press **Back** to return to the status list.
5. Press **Select** and select **Group** as a target of your status message.
6. Highlight required talkgroup and press **Select**, **PTT** or , or the relevant one-touch numeric key to send the status message.

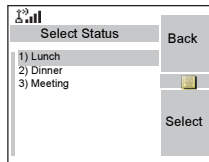

Targeted Status

If your Service Provider has enabled the Targeted Status feature, the status sending display will show you the option of sending your status to a private number or to a group.

To enter the private number, either key in the recipients number or press **abc** to search the contact list. For a group, select the group within the folder. Then send the status message.

The display will show one of the following delivery reports:

- **Status Sent** – the screen exits the status screen.
- **Sts Failed** – the screen returns within a few seconds to the previous display.

NOTE *Wait for the delivery report before sending a new status. If you enter the status menu from a busy talkgroup, audio is momentarily suspended to allow transmission of your status message.*

NOTE *If an Emergency call is received, the MTM800E immediately joins the Emergency call.*

NOTE *If set up by your Service Provider it is not possible to send a status message to a private number that is not in the Contacts List.*

Long Text Messages

TETRA infrastructure is supporting messages up to 1000 characters long. You can see the number of characters left. Received long text messages are editable and you can forward and reply them. Inbox and Outbox is sharing the memory. By receiving long text messages your storage area can be filled very quickly so remember to delete old messages.

NOTE *Long Text Messages can be disabled by the Service Provider.*

Store & Forward

This feature enables the host and mobile stations to communicate with each other without having to be available at the same time. The message is stored until the recipient is affiliated to the system or the expiration time was exceeded.

Call-Out

This feature allows the user to receive call-out alerts. When the Call-Out messages has been received by the radio, it interrupts current services and attends to the call-out alert without any further delay. After call-out alert has been cleared, the radio exits Call-Out mode and reverts back to normal mode. User is able only to receive Emergency Calls during Call-Out mode. There are four types of the Call-Out alert:

- Normal call-out
- Storm plan – it is sent to a group several time to raise reliability. User can only accept the Call-Out by pressing any button and is moved to information phase (soft keys are not labelled).

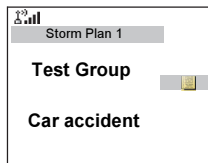

- Fallback Mode – it includes only voice communication. It can be cleared manually

NOTE *Fallback is only possible when Radio is in Local Site Trunking.*

- Test Call-Out – dispatcher has the ability to test this feature. Radio is generating the tone with “Call-Out Test” on the display. Only one softkey is enabled “Test OK” to confirm and to clear the test.

Interactions when the user is in other mode:

- TXI Mode – users can read the message but they can not respond to it. They have an option to leave the TXI Mode by pressing soft key or reject the Call-Out message.
- DMO Mode – Call-Out is not supported.
- Emergency Mode – all the Call-out alert are ignored.

Call-Out service phases

- Alerting phase – user receives a Call-Out message. The alarm tone indicates the message text is displayed and under it there are three options for the user to pick: Accept, Reject or **Menu**. If the user will accept the alert no other service from this point can interrupt. Menu key gives more choices (display on the right).

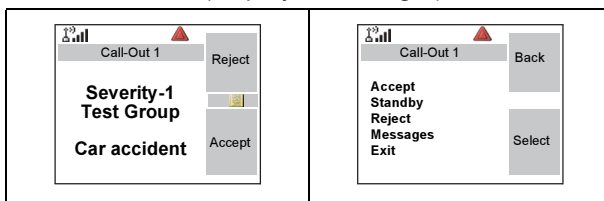

NOTE *The user can stop the alert tone by pressing PTT or any of the soft keys.*

- Information phase – user is still in the call-out mode and he can receive more detail information about the incident that occurred via subsequent text or the voice message. The user can query for more information using voice group call or Call-Out text function which enables the user to send a text message to the Service Provider. User can always respond and send back the text or the voice message using voice group call.

Call-Out Box

CO Box is giving to the user the option to view and store the Call-Out messages for future reference. To view them press **Menu > Messages > CO Box**. When the radio is in Call-Out Mode, you can only read the ongoing Call-Out messages.

WAP Box

Please go to “WAP Box” on page 95 to find more information.

Selecting the Text Entry Mode

Text entry modes make it easy for you to enter names, numbers, and messages.

In the text entry screen, select **Menu > Entry Mode**, and then select one of the following modes:

- **Primary** – for entering alphanumeric characters
- **Numeric** – for entering numbers only
- **Symbol** – for entering symbols only
- **Secondary** – for entering alphanumeric characters. (This mode is optional and you have to add it to the list.)

In the text entry screen, you can also press  repeatedly to change to Primary, Numeric, Symbol, or Secondary (if you have set it up).

Adding Secondary to the List of Text Entry Modes

Secondary is convenient when you use one language, and sometimes wish to switch to another one.

This mode appears in the list only if you set it up first via **Menu > Entry Setup**.

None is the default programming from factory and indicates no secondary entry mode is selected.

Selecting the Text Entry Method and Language

There are three text entry methods:



- **TAP** – Enter letters, numbers and symbols by pressing an alphanumeric key one or more times.
- **iTAP** – Let the terminal predict each word as you press an alphanumeric key.
- **Tap Hiragana** – Let the terminal predict each Japanese word as you press any key one or more times.

You can use these methods in the languages programmed in the terminal.

In the text entry screen, select the **Menu** button > **Entry Setup**, and then change to one of the methods and its related language (for example: TAP English).

Icons

In the text entry screen, icons tell you which text entry mode and method you are using. A character counter icon indicates the number of entered characters.

Primary Icons	Secondary Icons	Description
abc 1	abc 2	TAP – no capitals
Abc 1↑	Abc 2↑	TAP – capitalise next letter only
ABC 1↑	ABC 2↑	TAP – all capitals
abc 1	abc 2	iTAP – no capitals
Abc 1↑	Abc 2↑	iTAP – capitalise next letter only
ABC 1↑	ABC 2↑	iTAP – all capitals
 		Tap Hiragana – Japanese characters

Numeric Icon	Description
123	Enter numbers.

Symbolic Icon	Description
@	Enter punctuation and symbols.

TAP Display

Press a key and the display will show the following information:

- The icon indicating the current text writing method – see icons.
- The main text entry area that will hold your message after you selected the desired words.

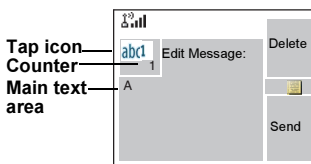

iTAP Display

Press a key and the display will show the following information:

- The icon indicating the current text writing method – see icons.
- The main text entry area that will hold your message after you selected the desired words.
- A row of suggested characters/words will be displayed.

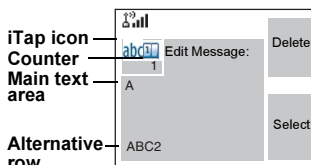

Tap Hiragana Display

Press a key and the display will show the following information:

- The icon indicating the current text writing method – see icons.
- The main text entry area that will hold your message after you selected the desired words.
- Two rows of suggested characters/words will be displayed.

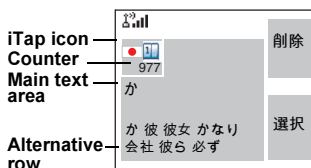









Keys Usage

NOTE Characters available for a key are examples and differ for each language setting (see “Setting the Display’s Working Language” on page 121).

List of Keys and Characters in Alphanumeric Mode (TAP/iTAP)

- Except for keys 0 and 1, the top line for each key shows numbers and upper case characters, and the lower line shows numbers and lower case characters.
- Press and hold any numeric key to enter Numeric mode.
- To exit Numeric mode in iTAP, select the word.
- To exit Numeric mode in TAP, press and hold any numeric key.



List of Keys and Characters in Alphanumeric Mode:

Key	Alphanumeric Mode (TAP/iTAP)
	Press to cycle through single shift, caps lock, and lower case.
	. , ? ! 0 1 @ ' " - () / : _ ; + & % * * = < > € £ \$ ¥ ¤ [] { } \ ~ ^ ` i \$ #
	A B C 2 a b c 2
	D E F 3 d e f 3
	G H I 4 g h i 4
	J K L 5 j k l 5
	M N O 6 m n o 6
	P Q R S 7 p q r s 7
	T U V 8 t u v 8

Key	Alphanumeric Mode (TAP/iTAP)
	W X Y Z 9 w x y z 9

Key	Alphanumeric Mode (Tap Hiragana)
	わ を ん わ 。 、 - 0
	あ い う え お あ い う え お 1
	か き く け こ 2
	さ し す せ そ 3
	た ち つ て と っ 4
	な に ぬ ね の 5
	は ひ ふ へ ほ 6
	ま み む め も 7
	や ゆ よ や ゆ よ 8
	ら り る れ ろ 9
	。 °





Entering Special Hiragana Characters

Hiragana characters can be modified by adding dakuten ° or handakuten °. Both are available under . Press  after you entered the character to add dakuten or handakuten marker.











Dakuten marker				
か > が	き > ぎ	く > ぐ	け > げ	こ > こ
さ > ざ	し > じ	す > ず	せ > ぜ	そ > ぞ
た > だ	ち > ぢ	つ > づ	て > て	と > と

Dakuten and handakuten marker				
は > ば	ひ > び	ふ > ぶ	へ > べ	ほ > ぼ
ぱ > ぱ	び > び	ぶ > ぶ	べ > べ	ぼ > ぼ

List of Keys and Characters in Numeric Mode:







Key	Numeric Mode
 to   to 	<ul style="list-style-type: none"> • Press to enter digit at insertion point. • Press and hold any numeric key to enter TAP alphanumeric mode. • To exit TAP alphanumeric mode, press and hold any numeric key.

List of Keys and Characters in Symbol Mode:

Key	Symbol Mode
	+ - * / \ [] = < > § #
	., ? ! @ ' " - () / : _ ; + & % x * = < > € £ \$ ¥ ¢ [] { } \ ~ ^ ¿ ¡ § #
	@ _ \
	/ , ;
	" & '
	() [] { }
	¿ ¡ ~
	= < >
	€ £ \$ ¥ ¢
	# % *

Other Keys:

Key	Description
Any numeric key	<ul style="list-style-type: none"> • In TAP press any key to reject word completion and continue with text entry A new completion will be displayed, if available, after the time-out for TAP expires. • Press and hold to enter Numeric mode from TAP or iTAP alphanumeric.

Key	Description
	<ul style="list-style-type: none"> • Press to insert a space. • In TAP press to dismiss a word completion and insert a space. • Enter a newly created word into the user dictionary. • Press and hold to enter a carriage return.
	<ul style="list-style-type: none"> • Press once to cycle through all entry modes (symbolic, numeric, primary and secondary if configured). • Press and hold to return to the default entry mode. • Press while in alternative row to enter the edited word.
Select	Press to select the highlighted choice and place it in the main text area.
Delete	<ul style="list-style-type: none"> • Press once to delete the last entered character. • Press and hold to clear the entire main text area.
	<ul style="list-style-type: none"> • In TAP press to reject word completion and scroll up. • In TAP press to change previously entered small letter to capital.
	<ul style="list-style-type: none"> • In TAP press to reject word completion and scroll within the text area. • In TAP press to change previously entered capital letter to small. • Press to be able to choose the word from the alternative row.
	<ul style="list-style-type: none"> • Press to navigate to the left. Press and hold to repeat • In TAP, if a word completion is available, press to reject the completion.
	<ul style="list-style-type: none"> • Press to navigate to the right. Press and hold to repeat. • In TAP if a word completion is available, press to accept the word.
	Opens the Context Sensitive Menu if a context sensitive menu is active.

Writing in iTAP Alphanumeric

For example, let's write "David 232!".



1. In the text entry screen, select **Menu > Entry Setup**, and then change to **iTAP English**. Press **Back** to return to the text entry screen.
2. In the text entry screen, select **Menu > Entry Mode**, and then select **Primary**.
3. Press . The alternative row opens up and shows D E F
3. Continue entering the letters by pressing one key for each letter. After entering 3 letters, the row shows the suggested words. Scroll the alternative row to the right until you reach David.
4. Press **Select** to select the word. It is displayed in the main text area.

NOTE

Automatic shift to upper case is used at the beginning of a message, after punctuation followed by space, or for the first letter of a word created as a new Contact entry.

5. Enter the numbers by pressing one key for each letter. The row shows the suggested numbers. Scroll the alternative row to the right until you reach the required combination.
6. To enter the symbol, press . The row shows the suggested symbol. Scroll the alternative row to the right until you reach the required symbol. Press **Select** to select the numbers. The numbers and symbol are displayed in the main text area.

Writing in Tap Hiragana

1. In the text entry screen, select **Menu > Entry Setup**, and then change **Primary** mode to **Tap Hiragana**. Press **Back** to return to the text entry screen.
2. In the text entry screen, select **Menu > Entry Mode**, and then select **Primary**.
3. Press . The alternative row opens up and shows か 彼女 彼女 かなり 会社 彼ら and so on. Press  to scroll the alternative row. Press  twice to highlight 彼女. Press **選択** to enter this word into the text editor.

Word Locking

You can use the partial or full word-lock feature to add words that are not in the dictionary and/or to narrow down the list of alternates to those that begin with a particular prefix.

1. Try to enter the word. Scroll the alternate line for a word option. Each option is successively highlighted and partially locked.
2. Enter the second part of the word. The first part remains unchanged (locked). The newly entered letters will be highlighted and then locked while you scroll to the next word option.
3. Press . The word is placed in the text area with a space and automatically added to the dictionary.



NOTE

This feature is not available in Tap Hiragana mode.

Writing in Numeric Mode

1. Press  to scroll to numeric mode. (OR, press and hold any numeric key to enter Numeric mode.)
2. Press the relevant numeric keys to insert the digits.

Writing in Symbol Mode

1. Press  to scroll to symbol mode.
2. Press . A series of symbols and punctuations appear on the screen.
3. Scroll to the symbol and press Select.

Writing in TAP Alphanumeric

1. In the text entry screen, select **Menu > Entry Setup**, and then change to TAP and its related language. Press **Back** to return to the text entry screen.
2. In the text entry screen, select **Menu > Entry Mode**, and then select **Primary**.
3. Press the key labelled with the desired character, once for the first character, twice for the second, and so on. For example, to enter “s”, press key  four times. To enter “7”, press the key five times. If you do not press a key for a few seconds, the character is accepted, and the cursor moves to the next position.

Adding Words to the Dictionary

Each language comes with its own dictionary. You can create words (including alphanumeric abbreviations). Once you create these words and added a space, they are automatically stored in the dictionary and appears as choices whenever you press the same key combination in the future.

NOTE

This feature is not available in Tap Hiragana mode.

What to do if...

Your MTM800E flashes the following messages:

Messages	Message Description
...-Rcvd	Call received but not answered, or rejected.
Attachment Failed	The MTM800E could not perform talkgroup attachment. The MTM800E keeps on trying. If it does not succeed, try another talkgroup.
Authenticate Failure	The MTM800E could not register on an Authenticated system (for example, the Authentication key is incorrect, or Authentication is disabled in the MTM800E).
Call Cancelled	Called MTM800E cancelled the call.
Call Ended	<ul style="list-style-type: none">• Faulty channel. Please try later.• Called MTM800E ended the call.
Call Preempted	Channel being used for priority.
Emgcy In Use: Wait For Mic	The Hot Microphone feature is active, but the channel transmit grant has been given to another Emergency Call on the same talkgroup. The MTM800E microphone is not active during this time, but the MTM800E will automatically try to regain talk permit after a predetermined time.
Emgcy Mic Ended	The Hot Microphone timer has automatically expired, or the user has pressed the PTT button to cancel the Hot Microphone feature.
Emgcy Mic On	The Hot Microphone feature is active, and the MTM800E is automatically transmitting hands free emergency audio.
Empty Entry	The speed number you dialled does not exist, or the number exists but the group is non-selectable.
Faulty Unit Error...	Self-test failed. An operational fault has been detected with your MTM800E. Record the error number. Turn your MTM800E off and contact service.









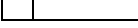

Messages	Message Description
Group already exists	The group you are attempting to add already exists in the My Groups folder.
Insufficient Visible Data	Your terminal is in the process of determining your location. This may take several minutes to complete.
Insufficient Visible Satellites	Your terminal is in the process of determining your location. This may take several minutes to complete.
Invalid ID	The entered number is not valid.
Invalid Shortcut position	The entered number is not valid.
Limited Service	Emergency Calls, Emergency Alarms and mobility operations (e.g.: group attachment) are allowed. All other incoming and outgoing call and data services are blocked.
List Empty	There are no programmed entries in the scrolling list. Type the entry.
List not Attached	All talkgroups in the scan list are not attached.
List Partially Attached	The scan list is active, but not all talkgroups are attached to it.
Message Delivered	Indicates mail successfully delivered.
Message Failed	Indicates mail delivery failure.
 Mode No Service	The MTM800E is outside coverage. Return to coverage.
My Groups is empty	You cannot view/delete groups when the My Groups folder is empty.
My Groups is full	You are not allowed to add a group to the My Groups folder as it already contains the maximum allowed number of groups.
Network Trouble	Network problems. Please try again later.

Messages	Message Description
No Answer	The called party does not answer.
No Entries	This message is displayed when accessing an empty list.
No Group	Attachment failed. MTM800E detached from current talkgroup. Please wait until the MTM800E attaches again to the current talkgroup.
No Group	<ul style="list-style-type: none"> • Displayed when you are out of the normal coverage area of your selected talkgroup. Please select a new talkgroup that is valid for your working location. • Indicates a favourite group was removed from the My Groups folder.
No List	The Network List is empty.
No New or Old Messages	Indicates there are no new or old messages in the Inbox.
No Selected Scan List	You selected an empty Network List (No List).
No Service	The MTM800E is out of coverage.
Not Allowed To Start Call	You are not allowed to dial a number which is not in the Address Book - if set up by your Service Provider.
Not Allowed To Transmit	<p>Release PTT and try again later.</p> <ul style="list-style-type: none"> • You are not allowed to send a text message or a status message to a number which is not in the Address Book - if set up by your Service Provider.
Only One Entry	There is only one programmed entry in the scrolling list.
Overheating	The MTM800E turns off. Keep it turned off for five minutes.
Party Busy	The called MTM800E is busy.
Party Not Available	<ul style="list-style-type: none"> • The called MTM800E is out-of-range. Please try again later. • The called MTM800E is turned off. Please try again later.





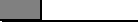









Messages	Message Description
Please Try Again	The s could not place the call.
Please Wait Connecting	A message during startup.
Registration Failure	The MTM800E could not register within the system. Please try again later.
Request Timed Out	Triggered by timer expiring - request was sent out properly but reply was not received while no network error was detected.
Service Denied	Invalid number. Call your Service Provider.
Service Not Available	This service is not available on the current network.
Service Restricted	This service has been restricted by your Service Provider, it has not been purchased, or it is not available.
Speaker Volume bars	Use Rotary knob to adjust volume level. (Rotary knob is programmed to "Dual" or "Volume").
Talkgroup ...Added	Group name added to the favourite talkgroup folder.
TG ... cannot be deleted	You cannot delete this group from the favourite talkgroup folder. Your Service Provider has set this group to non-deletable.
Try Again Later	The requested service is temporarily unavailable.
Unit Disabled	Check with Service Provider.
Unit is OK Warn...	Self-test error. A minor fault has been detected with your MTM800E. The MTM800E is still fully operative. Should this error recur, note the error code and contact service.
Unit Not Attached	The MTM800E could not attach to the system. The talkgroup may not be defined in the system. Please try another group.







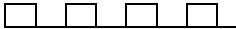



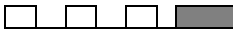
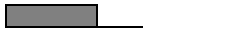

Messages	Message Description
Codeplug setting Error: CH Role Selection CH is powering OFF	The message is displayed when the control head configured as Slave is connected to the Transceiver and the control head configured as Master is connected as standalone (i.e. not to the Transceiver).
Standalone Mode Radio is powered OFF No available services	The message is displayed on Slave Control Head in Standalone mode.
Software Error: Incompatible SW ver. No available services	The message is displayed on Slave Control Head only when the software version is different than on Master.
Dual CH Link Error! Verify cables connection	The message is displayed when the connection between Control Heads is lost.
WAP initiated Not available on this unit End to abort the operation	The message is displayed on Slave when the Master Control Head is using WAP.

Tones

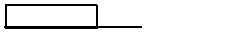
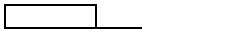
□ = High Tone; ■ = Low Tone		
Description	Type	Repeated
Idle		
<ul style="list-style-type: none"> • Back to Home display • Back to Rotary volume use when Rotary scroll timer expires • Back to coverage • Back to full service 		Once
Clear to send		Once
• Bad key press		Once
<ul style="list-style-type: none"> • Good key press • MTM800E self-test fails at power up • From out-of-service to in-service 		Once
In Call		
<ul style="list-style-type: none"> • Call clear warning • Call modified 		Once
Call waiting tone while Phone or Private Call are pending		Every 6 seconds, until a call is terminated
Data Connected or Data Disconnected.		Once
Talk Permit sounds upon pressing the PTT.		Once (Normal Tone)
		Once (Short Tone)
Talk Permit without gateway sounds upon pressing PTT. The tone indicates the gateway is no longer available.		Twice
		Once
<ul style="list-style-type: none"> • Talk Prohibit • System busy • Time-out timer expire • Called MTM800E not available or busy. 		Until you release the PTT

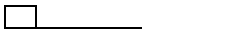
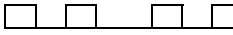
□ = High Tone; ■ = Low Tone

Description	Type	Repeated
Call disconnected or failed due to network		Once
Wrong number dialled.		No tone
DMO Entering		Once
DMO Exiting		Once
Local site trunking —Entering/Exiting		Once
Phone ring back (sending)		Every three seconds, until the called user answers or call is rejected
Phone busy		Every 0.5 seconds
Pressing the key to send the status to the dispatcher		Once
Status message sent to the dispatcher or failed		Once
Status message is not acknowledged by the dispatcher and the timer expires		Once
Incoming Calls		
Your MTM800E received a Group Call without gateway. (setup only)		Once
High Priority Group Call received		Once
Emergency Alarm sent or received		Twice
Emergency Alarm failed		Four times
Emergency Call received		Once
Phone ring (reception) Full-duplex Private Call	According to the Ring Style sub-menu setting.	Until you answer or the call is rejected

☐ = High Tone; ■ = Low Tone		
Description	Type	Repeated
Private Call received	According to the Ring Style sub-menu setting.	Until you answer or the call is rejected
Private Call ringing to the caller		Until the call is answered
Simplex Private Pre-emptive Priority Call (PPC) ring.		Every 4 seconds until the call is answered or rejected
Full-duplex Private PPC ring.		Every 4 seconds until the call is answered or rejected
Limited Service		Once upon entering limited service
New Mail Received		Once
New WAP Message		Once
New Group Call		Once
General		
Volume setting (earpiece, keypad, speaker)		Continuous
Volume setting (Ringer)		While setting the volume
Transmit Inhibit (TXI)		Once
Rotary knob tone		Once, when toggling from List to Volume
Low battery alert		Repeated
DTMF (0-9, #, *) during the call	DTMF 	Continuous, until the user releases the key
Double PTT - Single Tone		Once
Double PTT - Double Tone		Once
Double PTT - Triple Tone		Once
GPS		

☐ = High Tone; ■ = Low Tone		
Description	Type	Repeated
GPS in coverage	☐ _____	Once
GPS out of coverage	■ _____	Once
Dual Control Head		
Tone Single CH	■ ■ _____ ■ ■ _____	Once
Tone Dual CH	■ _____	Once
Tone Dual CH Error	☐ ☐ ☐ ☐ _____	Once

NOTE *Call-Out tones cannot be muted by the user.*

Index

A

- air encryption
 - key deletion 117
- AL (ambience listening) 69
- alarm
 - horn & light 20
- alias 20
- alphanumeric key
 - entering text (letters and digits) 7
- ambience listening (AL) 29, 69
- announcement talkgroup (ATG) 36
- ATG (announcement talkgroup) 36

B

- backlight
 - intensity 20
- backlight adjustment, one-touch 18
- backlight setup 123, 129
- bandwidth 149
- Book On 145
- broadcast group call 29
- browser
 - Openwave mobile browser 91
- browser menu 86
- button/footswitch 46
- buttons
 - emergency 17
 - push-to-talk (PTT) 8

C

- call dial, one-touch 18
- call queuing 64
- certificate authorities (CA) 90
- certificate authority (CA) 90
- cleaning your unit 11
- code changing 115

- contact list 110
- contacts sub-menu 110
- covert mode 9, 31
- covert mode, one-touch 18

D

- data setup 121
- date
 - display settings 126
 - one-touch 18
 - setting 127
 - setting format 127
- DGNA (Dynamic Group Number Assignment) 44
- diald call history 138
- diald number list 138
- dictionary 177
- direct mode operation (DMO) 23
- direct setup 26
- display
 - home 12
 - language setup 121
 - TAP/iTAP 169
 - text size setup 129
 - wallpaper setup 130
- displaying long text messages 152
- DMO (direct mode operation) 23, 47
- DMO group call
 - making 52
 - receiving 55
- DMO SCK 118
- DMO/TMO, one-touch 18
- DTMF over dial 67
- Dynamic Group Number Assignment (DGNA) 44

E

- emergency alarm

- sending in TMO 73
- emergency button 17
- emergency foot switch 9
- emergency group call 71
 - making in DMO 79
 - making in TMO 74
 - receiving in DMO 80
 - receiving in TMO 75
- emergency private call 72
- encryption
 - air encryption 116
 - air encryption key deletion 117
- end-stop rotary knob scrolling 40

F

- favourite group 134
- folder
 - favourite group 35, 48
 - scroll to next 40
 - selection 35, 48
 - stay in 40
- forced call 43
- four-way navigation key 8
- full-duplex private call 59

G

- gateway 47, 50
- global positioning system (GPS) 99
- GPS (global positioning system) 99
- GPS enable/disable 101
- group setup 131
- GW (gateway) 47

H

- half-duplex private call 59
- handsfree speakerphone 30
- history
 - dialed call 138
 - missed call 138
 - received call 138

- home display 12
- hook setup 26
- Hot Mic (hot microphone) 74
- hot microphone feature (Hot Mic) 74
- HTTP authentication 91

I

- icons
 - browser 81
 - contacts 111
 - data connected 13
 - data transmit/receive 13
 - direct mode 13
 - DMO gateway 13
 - DMO repeater 13
 - dual control head 15
 - dual control head link error 15
 - emergency 14
 - GPS 101
 - inbox 154
 - key press token 15
 - list scrolling 14
 - menu 106
 - new message arrived 14
 - new message(s) in inbox 14
 - no service 12
 - scan 12
 - signal strength (DMO) 13
 - signal strength (TMO) 12
 - single control head 15
 - speaker off (low audio) 14
 - TAP/iTAP 168
- ignition sense 9
- inbox use 154
- intensity 20
- InterMNI call 47, 78
- internet protocol (IP) 32
- IP (internet protocol) 32
- iTAP
 - display 169

- icons 168
- selecting 167
- writing text 167, 175

K

- K (key) 117
- key deletion 117
- keypad 7
 - locking/unlocking 115
 - usage in alphanumeric mode 170
 - usage in numeric mode 170, 172
 - usage in symbol mode 173
- keys
 - four-way navigation 8
 - menu 16
 - on-off/end/home 9
 - programmable numeric 18
 - programmable side 20
 - send 7
 - soft 16
 - speaker control 20
- knob
 - end-stop rotary knob
 - scrolling 40
 - rotary 17

L

- list of menu items 107
- local area service 31
 - entering 32
 - exiting 32
- local site trunking 31
- locking/unlocking the keypad 115

M

- menu 16
- menu item 105
- menu item list 107
- messages sub-menu 110, 151
- missed call history 138

- more... sub-menu 131
- MSPD (multi slot packet data) 33
- multi slot packed data (MSPD)
 - service 33
- my info sub-menu 137

N

- network list 132
- networks sub-menu 145
- non-tactical call 70
- notations 5
- numeric key, programmable 18

O

- one-touch
 - backlight adjustment 18
 - call dial 18
 - covert mode 18
 - date 18
 - DMO/TMO 18
 - screen saver 18
 - status message 18
 - talkgroup scan 18
 - talkgroup switch 18
 - text message template 18
 - time 18
 - TMO/DMO 18
 - transmit inhibit (TXI) 18
- on-off/end/home key 9
- open group 47, 79
- Openwave mobile browser 91

P

- PABX (private automatic branch exchange) 65
- PABX call 65
- packet data (PD) service 32
- PD (packet data) 32
- phone call 65
 - one-touch dialing 67
 - speed dial 66
- phone number 20, 65

- viewing and modifying 137
- phone/PABX call
 - answering 68
 - dialing via contact list 66
 - direct dial 65
 - making 65
- PIN (personal identification number) 114
- powering on/off 16
- PPC
 - making a private PPC 64
- PPC (pre-emptive priority call) 27
- predefined template 160
- pre-emptive priority call (PPC) 27
- presented call 43
- previous talkgroup switch 18
- private automatic branch exchange (PABX) 65
- private call 59
 - dialing on receiving a call 63
 - dialing via contact list 60
 - direct dial 59
 - making a full-duplex call 59
 - making a half-duplex call 59
 - receiving 62
 - short number dial 60
- private number 20
 - viewing 137
- programmable numeric key 18
- programmable side keys 20
- proxy 90
- PUK (personal unblocking key) 115
- push-to-talk button (PTT) 8

R

- received call history 138
- receiving calls 27
- recent calls sub-menu 138
- repeater 47, 51
- ring style of incoming call 120

- rotary knob 17
 - end-stop rotary knob scrolling 40
- RUA/RUI 11
- RUI 142

S

- scan list 35
- scan on/off in TMO group call 42
- scan setup 131
- scanning selection 35
- SCK (static cipher key) 118
- screen saver 21
- screen saver setup 129
- screen saver text 129
- screen saver, one-touch 18
- scrolling
 - end-stop rotary knob 40
- security sub-menu 113
- send key 7
- short number dial 60
- shortcuts sub-menu 140
- side keys, programmable 20
- site wide call 29
- site wide trunking 31
- soft keys 16
- speaker control key 20
- speakerphone
 - handsfree 30
- speed dial 66
- speed number 38
- status message 151
 - sending 161
 - targeting 162
- status message, one-touch 18

T

- tactical call 70
- talkgroup 35
 - speed number 38
- talkgroup scan, one-touch 18

- talkgroup selection 35, 48
- talkgroup switch, one-touch 18
- TAP
 - display 169
 - icons 168
 - selecting 167
 - writing text 167
- templates 151
- text language 168
- text message 151
 - sending 151
 - template
 - one-touch 18
- text size setup 129
- throughput 148
- time
 - display settings 126
 - one-touch 18
 - setting 127
 - setting format 126
 - setting offset 127
- time&date 22
- TMO (trunked mode operation) 23
- TMO group call
 - making 41
 - receiving 41
- TMO/DMO
 - one-touch 18
- tones
 - setting 'clear to send' 124
 - setting all tones 124
 - setting keypad tone 123
 - setting talk permit tone 124
- tones setup 123
- transmit inhibit (TXI)
 - mode 44
 - one-touch 18
- trunked mode operation (TMO) 23
- TXI (transmit inhibit) 44

U

- unblocking the terminal 115
- unlocking the terminal 114
- user defined template 159

W

- wallpaper setup 130
- WAP (wireless application protocol) 81
- WAP proxy 90
- WAP Tone 187
- wireless application protocol (WAP) 81
- wireless transport security (WTLS) 81
- writing text 167
- WTLS (wireless transport security) 81



MOTOROLA

MTM800E

Quick Reference Guide

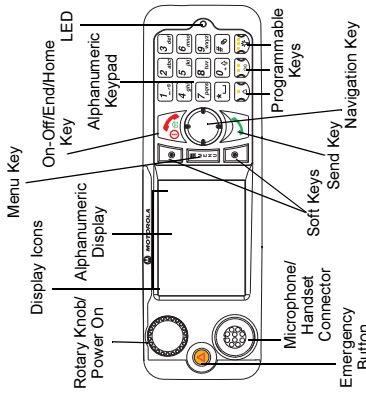

Turning the MTM800E On/Off

To power the MTM800E on/off, press and hold or the On push button.

Using the MTM800E Menu System

- To enter the menu, press the **Menu** button.
- To scroll through the menu, press or .
- To select a menu item, press **Select** soft key or .
- To return to previous level, press **Back** or .
- To exit the menu items, press .

Selecting Trunked/Direct Mode Operation

- Your terminal may be configured with a One-touch button to switch between TMO/DMO. Contact your Service Provider for more information.
- From the Home display press **Optns.**, select **Trunked Mode/Direct Mode**.

Making a TMO Group Call

From the Home display navigate to the desired group. Press **Select** soft key (if configured). Press and hold **PTT**. Wait for the talk permit tone (if configured) and talk. Release **PTT** to listen.

Making a DMO Group Call

Enter DMO. Navigate to the desired group. Enter **Select** soft key (if configured). Press and hold **PTT**. Wait for the talk permit tone (if configured) and talk. Release **PTT** to listen.

Making a TMO Emergency Group Call

Enter TMO. Press and hold the Emergency button. Emergency alarm is sent automatically. Press and hold **PTT**. Wait for the talk permit tone (if configured) and talk. Release **PTT** to listen. If using "Hot Mic" feature, wait for the **Emergency Mic On** message to appear on the display and talk without pressing **PTT**.

To exit Emergency Mode, press and hold **Exit** soft key.

Making a DMO Emergency Group Call

Enter DMO. Press and hold the Emergency button. Press and hold **PTT**. Wait for the talk permit tone (if configured) and talk.

Release **PTT** to listen. To exit Emergency Mode press and hold **Exit** soft key.

Making a TMO Simplex Private Call

From the Home display dial a number. Press **CType** to select the call type. Press and release **PTT**. Ringing sounds. Called party answers. Wait for the called party to finish speaking. Press and hold **PTT**. Wait for the talk permit tone (if configured) and talk. Release **PTT** to listen. Press to terminate call.

Making a DMO Simplex Private Call

Enter DMO. From the Home display dial a number. Press and hold **PTT**. Wait for the talk permit tone (if configured) and talk. Release **PTT** to listen. Press to terminate call.

Making a Full-duplex Private Call/Phone/PABX Call

From the Home display dial a number. Press **CType** to select the call type. Press and release . Ringing sounds. Called party answers. Press to terminate call.



Answering a Call

Your MTM800E switches to the incoming call and alerts you of the incoming call. To answer the call, press for Phone/PABX/Full-duplex Private calls or press **PTT** for all other calls.

Sending a Status Message

Select the desired group, then press the **Menu** button and select **Messages > Send Status**. Select status and press  or **PTT**.

Sending a New Message

Press the **Menu** button and select **Messages > New Message**. Write your message. Select **Send**, or press  or **PTT**. Select your mail recipient or enter number. Select **Send**, or press  or **PTT** to send the new message.

Tips & Tricks

- **Home Key**
Not sure where you are? Want to get back to Home display? Press .
 - **Backlight Control**
You can either disable backlight (covered operation) or have it automatically turned on, by any key press.
- You can also press the upper Side key - just to turn On/Off the backlight (if configured).

• **Menu Shortcuts**

You can easily access any menu item, by pressing the **Menu** button and a numeric key. (No delay between the **Menu** button and the key!)

You can ask your Service Provider to program menu shortcuts.

You may also define a new shortcut: enter the menu item, press and hold the **Menu** button, and follow the instructions in the display.

• **High/Low Audio Control**

You can control audio routing (speaker / earpiece) for any Private or Group Call via the dedicated speaker control key.

However, you can define via the menu to have all Group calls in high audio (**Menu** button > **Setup > Group Audio**).

• **Unified Contact List**

You can keep several numbers (Private, Mobile, Home, Work, PABX, Other) for the same person under the same contact name.

• **Text Size**

You can see the text on the display in two sizes: **Normal** or **Zoomed** (**Menu** button > **Setup > Display > Text Size**).

• **“My Groups” Folder**

You can select any group (TMO or DMO) and add it to your personal folder.

In the Home display, press  to quickly access your “My Groups” folder.



EN



MOTOROLA

www.motorola.com/tetra

68015000565-A

