



**MOTOROLA**

# *MTP850 Ex/MTP810 Ex TETRA Handportable Terminal*

*Basic User Guide*



When printed by Motorola

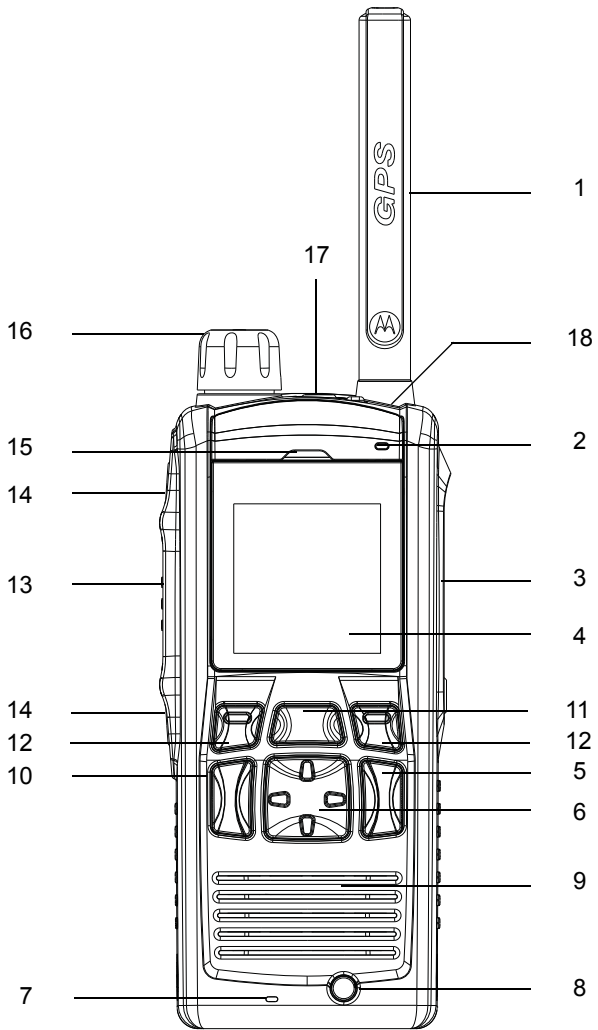

# Contents

---

<b>Safety Information</b> .....	<b>4</b>
Disposal Information .....	4
Copyright Information .....	4
Icon Conventions .....	5
<b>MTP850 Ex/MTP810 Ex Overview</b> .....	<b>6</b>
Controls and Indicators .....	6
Audio Signal Tones .....	8
Key, Knob, and Button Overview .....	11
On-Off/End/Home Key .....	11
Soft Keys .....	11
Menu Key .....	11
Rotary Knob .....	11
Emergency Button .....	12
Function Keys .....	12
Speaker Control Key .....	12
The LED Status Indicator .....	13
To Enter the Menu Items .....	13
To Return to the Previous Level .....	13
To Exit the Menu Items .....	13
List of Menu Items .....	14
The Display .....	16
Status Icons .....	17
Menu Icons .....	19
Inbox Icons .....	19
Contact Icons .....	20
<b>Getting Started</b> .....	<b>21</b>
Battery .....	21
Installing the Battery .....	21
Replacing the Battery .....	21
Charging the Battery .....	21
Additional Battery Warnings/Cautions .....	22
Battery Maintenance .....	23
Looking After the Battery .....	23

Battery Capacity Information . . . . .	24
Attaching the Antenna . . . . .	24
Powering On/Off (On-Off/End/Home Key) . . . . .	25
Powering On (Emergency Button) . . . . .	25
Powering On with Transmit Inhibit (TXI) Active . . . . .	25
Locking/Unlocking the Keypad . . . . .	26
Looking After Your MTP850 Ex/MTP810 Ex . . . . .	26
<b>Selecting TMO or DMO Operation . . . . .</b>	<b>27</b>
Entering TMO or DMO . . . . .	27
<b>Group Calls . . . . .</b>	<b>28</b>
“My Groups” Folder . . . . .	28
Selecting the “My Groups” Folder . . . . .	28
Adding a Group (TMO/DMO) to the “My Groups” Folder . . . . .	28
Selecting a Group . . . . .	28
Using the Rotary Knob . . . . .	28
Using the Navigation Key . . . . .	29
Using Alphabetic Search . . . . .	29
Using Folder Search . . . . .	29
Selecting a Folder . . . . .	29
TMO Group Calls . . . . .	29
Making a TMO Group Call . . . . .	29
Receiving a TMO Group Call . . . . .	30
Receiving a TMO Broadcast Call . . . . .	30
PTT Double Push . . . . .	30
DMO Group Calls . . . . .	31
Making a DMO Group Call . . . . .	31
Receiving a DMO Group Call . . . . .	31
Exiting DMO . . . . .	31
<b>Private, Phone, and PABX Calls . . . . .</b>	<b>32</b>
How to Dial . . . . .	32
Dialing via the Contact List . . . . .	32
Private Call . . . . .	32
Making a Private Call . . . . .	32
Receiving a Private Call . . . . .	33

Phone and PABX Calls .....	33
Making a Phone or PABX Call .....	33
<b>Emergency Mode .....</b>	<b>34</b>
Entering or Exiting Emergency Mode .....	34
Sending an Emergency Alarm .....	34
Hot Microphone Feature .....	35
Making an Emergency Group Call .....	35
Silent Emergency Mode .....	36
Man Down .....	36
Call-Out .....	36
<b>Messages .....</b>	<b>38</b>
Sending a Status Message .....	38
Sending a User-defined Message .....	38
Sending a Predefined Message .....	38
Handling New Incoming Text Messages .....	38
Handling Unread (New) Messages .....	39
<b>Tips &amp; Tricks .....</b>	<b>40</b>
<b>Quick Reference Guide .....</b>	<b>43</b>

© Motorola Inc., 2009

MOTOROLA and the stylized M Logo are registered in the U.S. Patent and Trademark Office. All other product or service names are the property of their respective owners.

# Safety Information



## CAUTION

*Before using this product, read the operating instructions for safe usage contained in the Product Safety and RF Exposure booklets 6864117B25/6866588D20 enclosed with your MTP850 Ex/MTP810 Ex.*

The MTP850 Ex/MTP810 Ex is restricted to occupational use only to satisfy ICNIRP RF energy exposure requirements. Before using this product, read the RF energy awareness information and operating instructions in the Product Safety and RF Exposure booklets (Motorola Publication part numbers 6864117B25/6866588D20 to ensure compliance with RF energy exposure limits.

Keep this **User Guide** and the **Product Safety and RF Exposure booklets** in a safe place and make it available to other operators in case the MTP850 Ex/MTP810 Ex is passed on to other people.

## Disposal Information



The **European Union Waste of Electrical and Electronic Equipment** directive requires that products sold into EU countries must have the crossed out trashbin label on the product (or the package in some cases). As defined by the WEEE directive, this cross-out trashbin label means that customers and end-users in EU countries should not dispose of electronic and electrical equipment or accessories in household waste.

Customers or end-users in EU countries should contact their local equipment supplier representative or service centre for information about the waste collection system in their country.

## Copyright Information

The Motorola products described in this manual may include copyrighted Motorola computer programs stored in semiconductor memories or other mediums. Laws in the United States and other countries preserve for Motorola certain exclusive rights for copyrighted computer programs, but not limited to, including the exclusive right to copy or reproduce in any form the copyrighted computer program.

Accordingly, any copyrighted Motorola computer programs contained in the Motorola products described in this manual may not be copied, reproduced, modified, reverse-engineered, or distributed in any manner without the express written permission of Motorola.

Furthermore, the purchase of Motorola products shall not be deemed to grant either directly or by implication, estoppel, or otherwise, any licence under the copyrights, patents, or patent applications of Motorola, except for the normal non-exclusive licence to use that arises by operation of the law in the sale of a product.

This document is copyright protected. Duplications for the purpose of the use of Motorola products are permitted to an appropriate extent. Duplications for other purposes, changes, additions or other processing of this document are not permitted. Only this electronically-saved document is considered to be the original. Duplications are considered merely copies. Motorola, Inc., and its subsidiaries and affiliates do not vouch for the correctness of such kinds of copies.

## Icon Conventions

The document set is designed to give the reader more visual cues. The following graphic icons are used throughout the documentation set. These icons and their associated meanings are described below.



**WARNING**

*The signal word **Warning** with the associated safety icon implies information that, if disregarded, could result in death or serious injury, or serious product damage.*



**CAUTION**

*The signal word **Caution** with the associated safety icon implies information that, if disregarded, may result in minor or moderate injury, or serious product damage.*

**CAUTION**

*The signal word **Caution** may be used without the safety icon to state potential damage or injury that is not related to the product.*

**NOTE**

*Notes contain information more important than the surrounding text, such as exceptions or preconditions. They also refer the reader elsewhere for additional information, remind the reader how to complete an action (when it's not part of the current procedure, for instance), or tell the reader where something is located on the screen. There is no warning level associated with a Note.*

# MTP850 Ex/MTP810 Ex Overview

## Controls and Indicators

The numbers below refer to the illustration on the inside front cover.

Number	Description
1	<b>Antenna</b>
2	<b>Top Microphone</b> Activated during Simplex, high-audio calls such as Group Calls.
3	<b>Side Connector</b> Used to connect accessories and for programming.
4	<b>Color Display</b> Provides alphanumeric text and images within 65,536 colours and 130 x 130 pixels with backlight, scalable fonts, and contrast.
5	<b>On-Off/End/Home Key</b> Press and hold to turn the MTP850 Ex/MTP810 Ex On/Off. Press to end calls. Press to return to the Home display (idle screen).
6	<b>Four Way Navigation Key</b> Press up, down, left or right for list scrolling, while moving around the menu hierarchy, or for alphanumeric text editing.
7	<b>Bottom Microphone</b> Activated during Simplex and Duplex, low-audio calls such as Phone Calls.
8	<b>Speaker Control Key</b> Selects earpiece (low audio) or speaker (high audio).
9	<b>Speaker (under the front panel)</b>
10	<b>Send Key</b> Used to initiate or answer Duplex calls (such as Phone Calls), or send status and text messages.
11	<b>Menu Key</b> Used to enter the main menu and the context sensitive menu.
12	<b>Soft Key(s)</b> Press to select the option that appears in the display directly above the left or right soft key.
13	<b>Push-To-Talk Button (PTT)</b> Press and hold this side button to talk in Simplex calls, release it to listen. Press to send status and text messages.



Number	Description
14	<b>Programmable Side Keys 1 and 2</b> Default programming: upper Side key activates/deactivates Backlight; lower Side key activates Screen Saver.
15	<b>Earpiece</b>
16	<b>Programmable Rotary Knob</b> Default programming: "Dual" - Press the knob to toggle between "volume" and "list". Side keys (No. 17) operate as programmed.
17	<b>Emergency Button (on top of the MTP850 Ex/MTP810 Ex)</b> Press <b>and hold</b> to enter Emergency Mode, and send Emergency Alarms (as programmed). When the MTP850 Ex/ MTP810 Ex is Off, press and hold to power on in Emergency Mode or in normal mode (as programmed).
18	<b>LED (Indicator)</b>











**NOTE** *Before using your MTP850 Ex/MTP810 Ex for the first time, remove the plastic lens protector from the display, and charge the battery overnight to ensure battery is initialised to its full capacity.*

**NOTE** *Take care to clean the side connector frequently and particularly prior to the programming procedure e.g. with a soft brush (do not use fluids).*











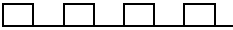





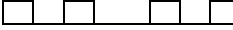

**NOTE** *It is recommended to turn off the terminal before connecting any of the accessories.*

## Audio Signal Tones

□ = High Tone; ■ = Low Tone;

Description	Type	Repeated
<b>Idle</b>		
<ul style="list-style-type: none"> <li>• Back to Home display</li> <li>• Back to rotary volume use when rotary scroll timer expires</li> <li>• Back to coverage</li> <li>• Back to full service</li> </ul>		Once
Clear-to-send		Once
Bad key press		Once
<ul style="list-style-type: none"> <li>• Good key press</li> <li>• MTP850 Ex/MTP810 Ex self-test fails at power up</li> <li>• From out-of-service to in-service</li> </ul>		Once
<b>In Call</b>		
Call clear warning		Once
Call waiting tone while Phone or Private Call are pending.		Every 6 seconds, until a call is terminated
Data connected or Data disconnected		Once
Talk permit sounds upon pressing the PTT.		Once (Normal Tone)
		Once (Short Tone)
Talk permit without gateway sounds upon pressing PTT. The tone indicates the gateway is no longer available.		Twice
		Once

Description	Type	Repeated
<ul style="list-style-type: none"> <li>Talk prohibit</li> <li>System busy</li> <li>Time-out timer expire</li> <li>Called MTP850 Ex/ MTP810 Ex not available or busy</li> </ul>		Until you release the PTT
<ul style="list-style-type: none"> <li>Call disconnected or failed due to network</li> <li>Wrong number dialed</li> </ul>		Once
DMO (Direct Mode) Entering		Once
DMO Exiting		Once
Local site trunking – Entering/Exiting		Once
Phone ring back (sending)		Every three seconds, until the called user answers or call is rejected
Phone busy		Every 0.5 seconds
Status message sent to the dispatcher or failed.		Twice
<b>Incoming Calls</b>		
Status message acknowledged by the dispatcher.		Four times
Your MTP850 Ex/MTP810 Ex received a Group Call without gateway (setup only)		Once
High-priority Group Call received		Once
Emergency Alarm sent or received		Twice
Emergency Alarm failed		Four times
Emergency Call received		Once
Phone ring, Duplex Private Call (reception)	According to the Ring Style sub-menu setting.	Until you answer or the call is rejected



Description	Type	Repeated
Private Call received		Until the call is answered
Private Call ringing to the caller		Until the call is answered
Simplex Private Pre-emptive Priority Call (PPC) ring		Every 4 seconds, until the call is answered or rejected
Duplex Private PPC ring		Every 4 seconds, until the call is answered or rejected
Limited service		Once, upon entering limited service
New mail received		Once
New Group Call		Once
<b>Battery/General</b>		
Volume setting (earpiece, keypad, speaker)		Continuous
Volume setting (ringer)		While setting the volume
Transmit Inhibit (TXI)		Once
Rotary knob tone		Once, when toggling from list control to volume control
Low battery alert		Repeated
Man Down feature is on		Once
Man Down feature is off		Once or Repeated
Man Down pre-alert		Once
Man Down device failure		Until you disable the feature
Double PTT - Single Tone		Once
Double PTT - Double Tone		Once
Double PTT - Triple		Once

# Key, Knob, and Button Overview

## On-Off/End/Home Key

- Press and hold to turn the MTP850 Ex/MTP810 Ex On/Off.
- Press to end calls.
- Press to return to the Home display.

## Soft Keys

Press  or  to select the option that appears in the display directly above the left or right soft key.

## Menu Key

Menu key has 2 functions. Press  to enter:

- **The menu** (when not in the menu). The MTP850 Ex/MTP810 Ex menus allow you to control your MTP850 Ex/MTP810 Ex settings.
- **Context sensitive menu** (when  icon is on and while not on Idle screen) to view a list of items for the current menu.

## Rotary Knob

The Service Provider can program the Rotary knob to one of the following uses:

1. **Dual control** - the knob is used as both a volume control and to scroll through lists. Press the knob to toggle between volume and list control (default programming).
2. **List control** - the knob is used to scroll lists (e.g. Talk group lists) or menu items. In this case volume control is always via the Side keys.
3. **Volume control** - the knob is used only as a volume control; turn clockwise to increase the audio volume level.

Press and hold the Rotary knob to lock it, press and hold it again to unlock. Powering Off also unlocks a locked Rotary knob.

## Emergency Button

Press and hold this button to enter Emergency Mode.

When the MTP850 Ex/MTP810 Ex is powered down, press and hold this button to power On in Emergency Mode or in standard mode (as programmed).

## Function Keys

**NOTE** *For information on the function assigned to each Side key, please refer to your Service Provider.*

**NOTE** *The required time you need to press the Side keys to activate a one-touch function is set as default to 1 second. This time may be set, however, by your Service Provider.*

## Side Keys

The Rotary knob and Side key programming are paired:

Rotary Knob Programming	Side Key Programming
Dual control	Programmed to a one-touch function
List control	○: Volume Up ●: Volume Down
Volume control	Programmed to a one-touch function

When the Rotary knob is programmed to volume control or dual control, the Side keys support the one-touch feature that allows you to select or activate commonly used features by pressing and holding a single key. By default, the upper Side key is set to “Backlight On/Off” and the lower Side key is set to “Screen Saver On”. Please check with your Service Provider.

## Speaker Control Key

Press  to activate the earpiece (low audio) or speaker (high audio), depending on the menu settings.

Type of Call	Menu Setting	Key Use
Simplex call (Group*/Private)	Menu > Setup > Audio > Audio Toggle > Spkr Cntrl	Speaker On/Off for Group and Private Calls
	Menu > Setup > Audio > Audio Toggle > Always Loud	Speaker On/Off for Private Call

\* In an Emergency Group Call, the voice sounds from the speaker regardless of the speaker setting.



**NOTE** Duplex calls (Private/Phone/PABX) always use low audio.

## The LED Status Indicator

The indicator shows the states of your MTP850 Ex/MTP810 Ex.

Indicator	Status
Solid green	In use
Flashing green	In service
Solid red	Out of service
Flashing red	Connecting to a network/Entering DMO
Solid orange	Transmit Inhibit (TXI) in service / Channel busy in DMO
Flashing orange	Incoming call
No indication	Switched off

## To Enter the Menu Items

1. Press .
2. Scroll to the required item, press **Select** or  to select.

## To Return to the Previous Level

Press **Back** or .

## To Exit the Menu Items

Press .

**NOTE** Your MTP850 Ex/MTP810 Ex may exit if no key press is detected for a time-out period.

# List of Menu Items

English

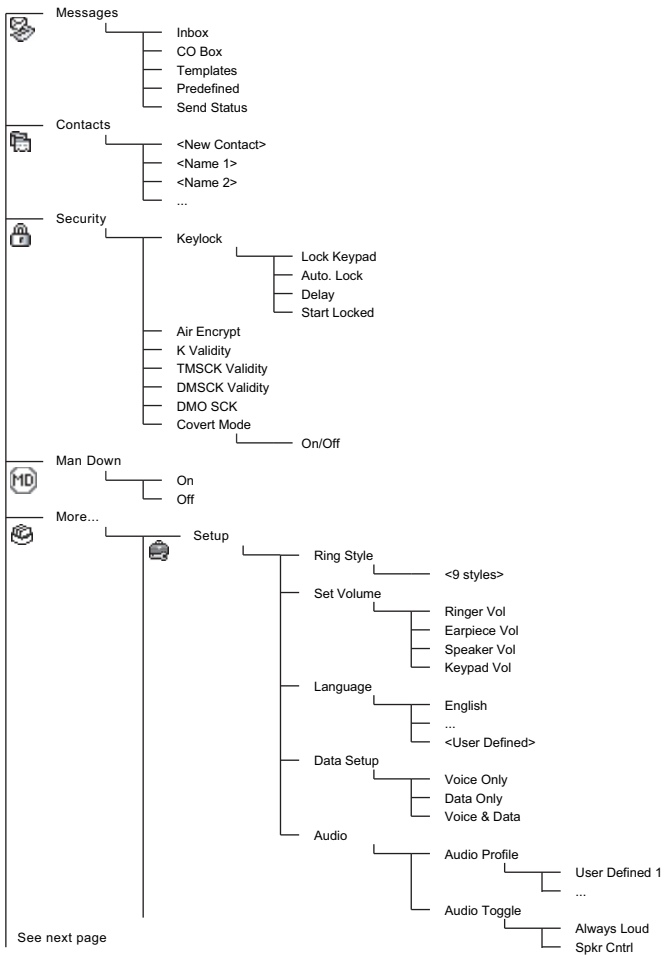



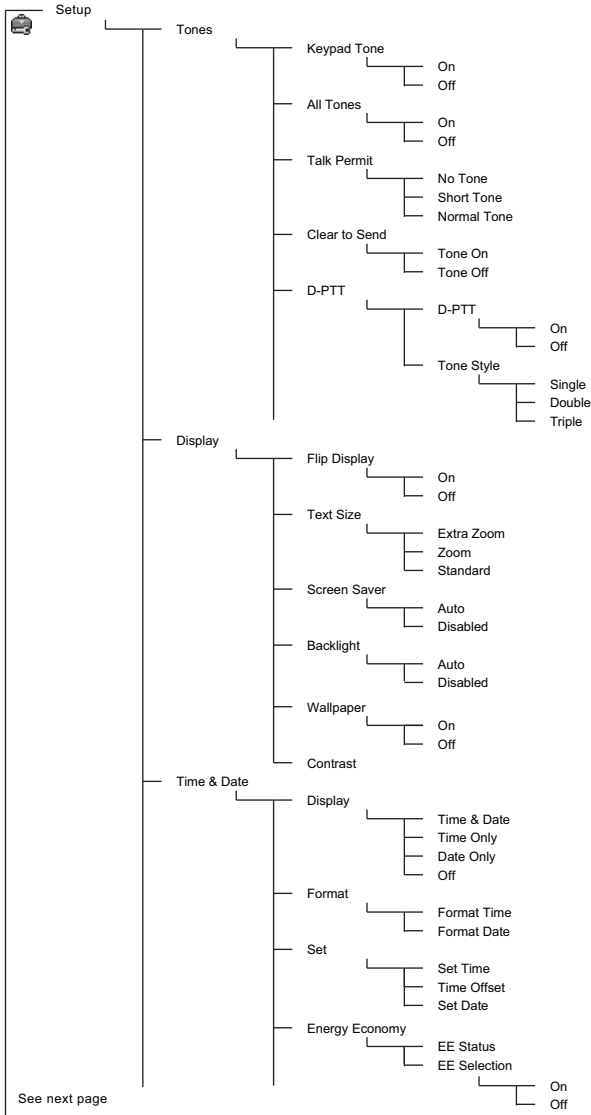

See next page

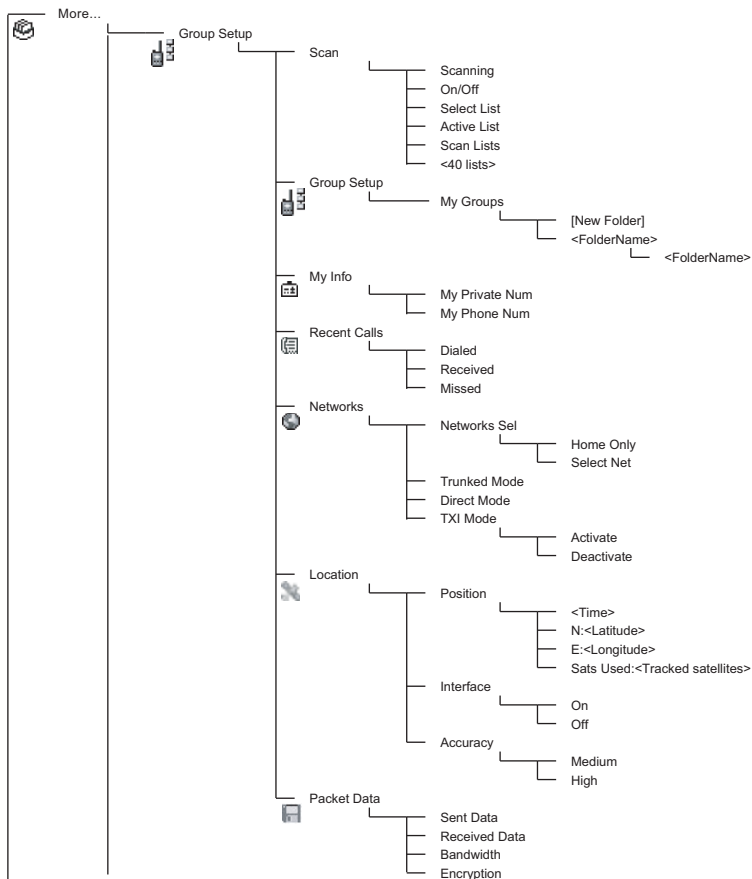
**NOTE**









*This is the standard menu layout. Your Service Provider may enable/disable some menu items or change their names.*











## The Display

When you use your MTP850 Ex/MTP810 Ex, icons appear on the display to indicate the following conditions.

## Status Icons









Status icons appear when your phone is engaged in certain activities or when you have activated certain features.

Status Icon	Description
<b>Trunked Mode Operation (TMO)</b>	
	<b>Signal Strength</b> Allows you to check signal strength. More bars indicate a stronger signal.
	<b>No Service</b>
	<b>Scan</b> Indicates scanning is activated in the MTP850 Ex/MTP810 Ex.
	<b>Data Connected</b> Displayed when the MTP850 Ex/MTP810 Ex is successfully connected to an external device and ready for data transfer.
	<b>Data Transmit/Receive</b> Displayed when the MTP850 Ex/MTP810 Ex is transferring data to/receiving data from the external device (laptop or desktop PC). <b>No number</b> – standby data session. <b>Number 1, 2, 3, or 4</b> – indicates active data session with 25%, 50%, 75%, or 100% bandwidth.
<b>Direct Mode Operation (DMO)</b>	
	<b>Signal Strength</b> Indicates an incoming Direct Mode Group Call.
	<b>Direct Mode</b> Displayed when the MTP850 Ex/MTP810 Ex is in Direct Mode.
	<b>DMO Gateway</b> Indicates that gateway is selected. The icon has three states: <b>Solid</b> – while the MTP850 Ex/MTP810 Ex is synchronised with the gateway. <b>Flashing</b> – while the MTP850 Ex/MTP810 Ex is not synchronised or when it is attaching to the gateway. <b>No icon</b> – during a terminal to terminal and repeater call.

Status Icon	Description
	<p><b>DMO Repeater</b>            Displayed when the repeater option in DMO is selected. This icon has three states:  <b>Solid</b> – while the terminal has detected the repeater (that is, when the terminal receives a presence signal.)  <b>Blinking</b> – while the terminal has not detected the repeater or during attachment.  <b>No icon</b> – during a terminal to terminal and gateway call.</p>
<b>General Icons</b>	
	<p><b>All Tones Off</b>            Indicates that all alert tones are off in the MTP850 Ex/ MTP810 Ex.</p>
	<p><b>Speaker Off (Low Audio)</b>            Indicates that the audio will sound through the earpiece. (See detailed explanation of Speaker Control key.)</p>
	<p><b>Battery Strength</b>            Shows the charge in your battery. Full icon is full charge.</p>
	<p><b>Emergency</b>            Appears while the MTP850 Ex/MTP810 Ex is in Emergency Mode.</p>
	<p><b>List Scrolling</b>            Displayed to indicate that the Rotary knob use is list scrolling, as long as this use is selected.</p>
	<p><b>New Message Has Arrived</b>            Indicates a new message just arrived.</p>
	<p><b>New Message(s) in Inbox</b>            Indicates that you have unread messages in your inbox.</p>
	<p><b>Man Down Active (Blue)</b>            Indicates that the Man Down feature is active.</p>
	<p><b>Man Down Alert (Red)</b>            Displayed when the Man Down feature is active. This icon has two states:  <b>Blinking</b> – pre-Alert; the terminal signalizes Man Down conditions. To exit the pre-Alert state, change the conditions or press the PTT button.  <b>Solid</b> – the terminal entered the Alert mode.</p>
	<p><b>Man Down Failure</b>            Indicates the Man Down device failed.</p>





## Menu Icons

The following icons make it easy to identify the menu items at first glance.

Menu Icon	Description
	<p><b>Main Menu Items/Context Sensitive Menu</b></p> <p>Appears above  if the main menu items/context sensitive menu are active.</p>
	<p><b>Messages</b></p> <ul style="list-style-type: none"> <li>• Send status messages,</li> <li>• Send short text messages (free text or according to user defined or predefined templates),</li> <li>• Receive messages in inbox.</li> </ul>
	<p><b>Contacts</b></p> <p>Add, search, edit, or erase entries in the contact list.</p>
	<p><b>Security</b></p> <p>Lets you turn On/Off and verify security features, and change passwords.</p>
	<p><b>Setup</b></p> <p>Allows you to customise your MTP850 Ex/MTP810 Ex.</p>
	<p><b>More...</b></p> <p>Contains more customisable menu items.</p>
	<p><b>Scroll Bar</b></p> <p>Indicates navigation among items that occupy more than one screen. If all items appear in one screen, the scroll bar is empty.</p>







## Inbox Icons

The following icons indicate the status of messages in the inbox.

Inbox Icon	Description
	<p><b>Unread (New) Message</b></p> <p>Indicates that you have not read the message yet.</p>
	<p><b>Read (Old) Message</b></p> <p>Indicates that you have read the message.</p>
	<p><b>Sender Information in Message View</b></p> <p>Indicates sender information (name or number).</p>
	<p><b>Time and Date Stamp in Message View</b></p> <p>Indicates the time and date of message arrival.</p>

## Contact Icons

In the contact list display, the following icons may appear next to the contact numbers to indicate the type of stored number.

Contact Icon	Description
	<b>Private ID Number</b>
	<b>Mobile Phone Number</b>
	<b>Home Phone Number</b>
	<b>Work Phone Number</b>
	<b>PABX Number</b>
	<b>Other Phone Number</b>
	<b>Pickers</b> Indicate more than one number is stored with the contact.

# Getting Started

---

## Battery

### Installing the Battery

1. Remove the battery from its protective clear plastic case.
2. Insert the battery top into the compartment as illustrated.
3. Carefully slide the battery until it clicks into place.

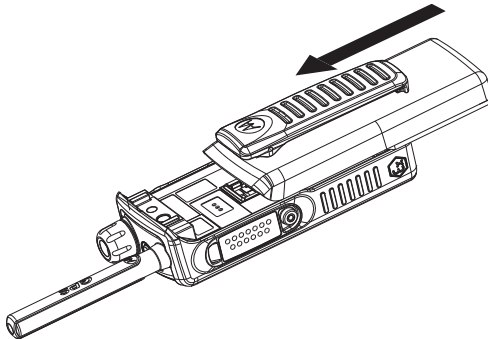

### Replacing the Battery

To remove the battery:

1. Lift the latch on the bottom as per markings.
2. Pull the battery out.
3. Replace the battery.



**WARNING**

*Battery changing is NOT allowed in gas and dust environment. Battery replacing must occur ONLY in non-hazardous areas.*

### Charging the Battery

Motorola approved chargers provide optimum performance. Other chargers may not fully charge your Motorola Lithium-Ion battery or may reduce the life of the battery.



**WARNING**

*Battery charging must occur ONLY in non-hazardous areas. After charging, the radio must be left to rest for at least 3 minutes.*

To charge the battery:

1. Switch the MTP850 Ex/MTP810 Ex **Off** before charging.
2. Insert the battery, or the radio with battery into the charger socket. Select the required plug adapter (UK or European type) and connect to the charger. Then plug the charger into a suitable mains socket.
3. The charger's LED indicator displays the charging status.

Indicator	Status
Solid green	The battery is fully charged.
Flashing green	The battery is charged - 90% capacity or more.
Solid red	The battery is charging.
Flashing red	The battery is not chargeable or not making a proper contact.
Flashing orange	The battery is in the charger, waiting to be charged.
No indication	The battery is inserted incorrectly.

**NOTE**

*Batteries charge within the temperature range of 0°C to 45°C for Li-Ion batteries. If a battery is outside this temperature range, no charge current is supplied to the battery.*

## Additional Battery Warnings/Cautions

- Battery Storage above 60°C (140°F) and below -20°C (-4°F) is NOT recommended.
- To prevent injury, do not allow metal objects to contact the battery terminals.
- Do NOT disassemble.
- Do NOT throw in fire.
- Do NOT dispose of battery in household waste.



## Battery Maintenance

- As part of an Annual Battery Maintenance Program or as required (when the battery contacts are dirty or show signs of wear) it is recommended that the Battery's Radio-side and Charger-side contacts are cleaned with DeoxIT®GOLD cleaner/lubricant. DeoxIT®GOLD (Supplier CAIG Labs, P/N G100P) cleaner/lubricant pen has been found to be very effective at cleaning and extending the life of the battery's contacts. DeoxIT®GOLD cleaner/lubricant is available at numerous electronics suppliers (Radio Shack, McMaster Carr, Fry's, etc.) and directly from manufacturer, CAIG Labs, at <http://www.caig.com>. This pen based package is recommended as it provides better access to the recessed contacts of the battery. The pen's tip may need to be modified (trimmed on the sides) to improve penetration into the battery contact slots. Per the manufacturer's instructions, shake the pen until the fluid begins to flow and wipe the battery's contact surface with the felt tip. After cleaning, inspect the contact surfaces for signs of advanced wear. Advanced contact wear is defined as wear through either the contact platings (gold and nickel) to the base metal (copper). Copper exposure is characterized by a distinctive orange-brown metal appearance surrounded by the silvery nickel underplate and gold top coat. In some cases, a magnified (10x minimum) inspection may be required to verify wear through to the base material. Polishing of the gold or nickel surface is common and is not considered a need for replacement. In instances where advanced wear is evident, the battery should be replaced.
- After cleaning the contact areas of any foreign material, let the lubricant/cleaner dry for 2 minutes. Replace the battery on the radio and test for intermittency by moving the battery relative to the radio as might occur in regular use. Regular maintenance (at least annually) of this area is recommended to ensure contamination free interface and to prolong the life of the battery contacts.

## Looking After the Battery

To clean the battery, use a moistened or antistatic cloth.

DO NOT use a dry or electrostatically charged cloth.

DO NOT rub or clean the battery with solvents to avoid any risk of ignition due to the build up of electrostatic charges.

## Battery Capacity Information

Information	Description
Green icon	Full (50% - 100% capacity)
Yellow icon	Middle (20% - 50% capacity)
Red icon	Low (10% - 20% capacity)
Empty icon	Very low (5% - 10% capacity)
<b>Low battery</b> message	Less than 5% capacity



Empty

Full

### Battery Capacity

## Attaching the Antenna

**NOTE** Turn the MTP850 Ex/MTP810 Ex Off before installing or removing the antenna.

Insert the bottom of the antenna into the screw-in base on the top of the MTP850 Ex/MTP810 Ex. Turn clockwise until snug. **Do not force.**

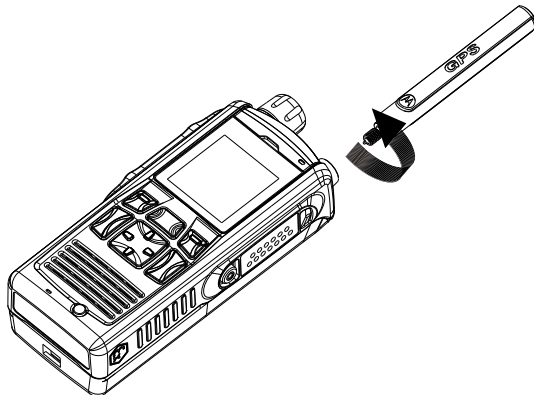

## Powering On/Off (On-Off/End/Home Key)

To power **On**, press and hold . Your MTP850 Ex/MTP810 Ex performs a self-check and registration routine. After successful registration, the MTP850 Ex/MTP810 Ex is in service.

To power **Off**, press and hold . You will hear a beep and the **Powering Off** message is displayed.

## Powering On (Emergency Button)

Press and hold the Emergency button to power **On**. The MTP850 Ex/MTP810 Ex will power **On** in Emergency Mode or in standard mode (as programmed).

## Powering On with Transmit Inhibit (TXI) Active

Transmit Inhibit is a feature allowing you to switch off transmission before entering a Radio-Frequency (RF) sensitive area. To activate this feature, press  and select **More... > Networks > TXI Mode > Activate**.



### WARNING

*Pressing the Emergency button, even if Transmit Inhibit is activated, causes the MTP850 Ex/MTP810 Ex to transmit immediately. The MTP850 Ex/MTP810 Ex must NOT be within the RF sensitive area when entering Emergency Mode.*

The TXI Mode remains active at power **On**. You will be asked whether to leave the TXI Mode **On** or not.







### WARNING



*Ensure you have left the RF sensitive area before deactivating Transmit Inhibit.*

Press the **Yes** soft key to deactivate the TXI Mode. If the MTP850 Ex/MTP810 Ex was previously used in Trunked Mode, it will register to the network. If the MTP850 Ex/MTP810 Ex was previously used in Direct Mode, it will remain in Direct Mode.

Press **No** in Trunked Mode and the MTP850 Ex/MTP810 Ex powers down; press **No** in Direct Mode and you remain in Direct Mode with TXI selected.

## Locking/Unlocking the Keypad

Press   to lock the keypad. Press again   to unlock.

**NOTE** *Your Service Provider can lock the keypad with and without the PTT,  and  during incoming call, but the Rotary knob and  are always available.*

**NOTE** *The Emergency button is not locked. Pressing the Emergency button unlocks the keypad.*

### **Automatic Keylock**

This feature locks the keypad automatically after not using it for a predefined time. To turn it on/off or to set the delay go to **Menu > Security > Keylock Setup**.

### **Keypad Lock on Startup**

The user can set the Keylock at the start up of the terminal.  
To turn it on / off go to **Menu > Security > Keylock > Start Locked**.

## Looking After Your MTP850 Ex/MTP810 Ex

To clean your MTP850 Ex/MTP810 Ex, use a moistened or antistatic cloth.

DO NOT use a dry or electrostatically charged cloth.



DO NOT rub or clean the radio with solvents to avoid any risk of ignition due to the build up of electrostatic charges.

# Selecting TMO or DMO Operation

---

## Entering TMO or DMO

Enter TMO or DMO in one of the following ways:

- From the Home display press **Optns** and select **Direct Mode** if the MTP850 Ex/MTP810 Ex is in TMO.
- From the Home display press **Optns** and select **Trunked Mode** if the MTP850 Ex/MTP810 Ex is in DMO.
- Press  and select **More... > Networks > Trunked Mode** if the MTP850 Ex/MTP810 Ex is in DMO.
- Press  and select **More... > Networks > Direct Mode** if the MTP850 Ex/MTP810 Ex is in TMO.
- Press the TMO/DMO one-touch button (if programmed by your Service Provider).

You can make and receive the following types of calls when the MTP850 Ex/MTP810 Ex operates in Trunked Mode:

- Group Calls
- Private Calls
- Private Calls via MS-ISDN
- Phone Calls
- PABX Calls – local (office) extension calls
- Emergency Calls.

You can make and receive Group Calls when the MTP850 Ex/MTP810 Ex operates in Direct Mode. This includes Emergency Group Calls.

The MTP850 Ex/MTP810 Ex returns to the Home display when there is no activity for a few seconds.

### NOTE

*Your terminal can alert you of an incoming call. Select the alert settings in the Tones menu items.*

# Group Calls

---

A Group Call is a communication between you and others in a group. A group is a pre-defined set of subscribers enabled to participate in and/or invoke a Group Call.

Groups are organised in **folders**. Each folder may contain several groups.

## “My Groups” Folder

You can organise your favourite groups into one folder called “My Groups”.

## Selecting the “My Groups” Folder

From the Home display, press  to quickly access the folder.

## Adding a Group (TMO/DMO) to the “My Groups” Folder

1. Press  and select **More > Group Setup > My Groups > Edit List > [New Group]**.
2. Select a group by alphabetic search (“**TMO/DMO by abc**”) or select a group by folder search (“**TMO/DMO by Folder**”). Select the folder and select the group.  
The group is added to the “My Groups” folder.

## Selecting a Group

**NOTE** *When you navigate in the “My Groups” folder and select a DMO group, your terminal will switch between TMO and DMO (and vice-versa).*

## Using the Rotary Knob

(If programmed)

From the Home display, press shortly on the Rotary knob and rotate until the requested group appears.

Group selection occurs:

- After a time-out
- By pressing **Select** (if configured by your Service Provider)

## Using the Navigation Key

From the Home display, scroll left or right until the requested group appears. Then press **Select** to confirm selection.

## Using Alphabetic Search

From the Home display, press **Optns**. Select a group by alphabetic search (“**TG by abc**”). Search through alphabetically ordered

groups using  or . Select the group.

## Using Folder Search

From the Home display, press **Optns**. Select a group by folder search (“**TG by Folder**”). Select the folder and select the group.

## Selecting a Folder

From the Home display, press **Optns**. Select **Folder**, and select the desired folder. The display shows the last selected group in that folder.

## TMO Group Calls

In TMO the MTP850 Ex/MTP810 Ex is used with your Service Provider’s infrastructure.

## Making a TMO Group Call

1. From the Home display and if this is the required group, press and hold the **PTT**.
2. Wait for the talk permit tone and then speak into the microphone. Release the **PTT** button to listen.

When you start a call, all members of the selected group who have their units turned on, will receive the Group Call.

### NOTE

*If you are in an on-going Group Call and wish to make a new call,*

*press  to ignore the current call. Start the new call.*

### NOTE

*The **No Group** message is displayed when you are out of the normal coverage area of your selected group. You must then select a new group that is valid for your working location.*

## Receiving a TMO Group Call

Unless it is engaged in a call, your MTP850 Ex/MTP810 Ex will receive the Group Call. To answer the call, press and hold **PTT**.

Your MTP850 Ex/MTP810 Ex shows the group name and the caller's private number or alias if previously stored in your contact list.

## Receiving a TMO Broadcast Call

The Broadcast Call (also called Site Wide Call) is a high-priority Group Call from the console operator (or dispatcher) to all users.

The MTP850 Ex/MTP810 Exs are configured to monitor a Broadcast Call, but users cannot talk back.

The Broadcast Call pre-empts an on-going Group Call that has the same (or lower) call priority.

## PTT Double Push

This feature, if enabled by your Service Provider, allows you to send the tone when the radio is in idle or Group Call mode by pressing PTT twice.

**NOTE** *This feature interacts as the PTT pressed to invoke the Group Call.*

After the D-PTT tone is played, the user can press and hold the PTT once again to get the permission to talk. To activate/deactivate the D-PTT Tone:

1. From the main menu, select **Setup > Tones > D-PTT Tones > D-PTT Mode**.
2. Choose required setting, and press **Select**. Press **Back** to exit.

To choose the tone:

1. From the main menu, select **Setup > Tones > D-PTT Tones > Tone Style**.
2. Choose the tone between three options: **Single**, **Double** or **Triple**. Please go to D-PTT Tones on page 10 to view the specification of the tones.



## DMO Group Calls

In DMO the MTP850 Ex/MTP810 Ex can be used without your Service Provider's infrastructure.

DMO allows communication with other terminals also operating in DMO, which are on the same frequency and group as your MTP850 Ex/MTP810 Ex.

**NOTE** *In DMO it is only possible to place the following call types: Group Calls, Emergency Group Calls and Private Simplex Calls.*

When you start a call, the members of the selected group who have their units turned on will receive the Group Call.

In DMO the MTP850 Ex/MTP810 Ex can communicate with the trunking system (and vice-versa) if the Gateway option is enabled in the MTP850 Ex/MTP810 Ex.

### Making a DMO Group Call

1. Enter **Direct Mode** by pressing **Optns** and selecting **Direct Mode**.
2. Make sure that you have selected the required group. Press and hold the **PTT** button.
3. Wait for the talk permit tone and then speak into the microphone. Release the **PTT** button to listen.

### Receiving a DMO Group Call

You can receive a DMO Group Call only when your MTP850 Ex/MTP810 Ex is in DMO.

Unless it is engaged in a call, your MTP850 Ex/MTP810 Ex will receive the Group Call. To answer the call, press and hold **PTT**.

Your MTP850 Ex/MTP810 Ex shows the group name and the caller's private number or alias if previously stored in your contact list.

### Exiting DMO

To exit DMO, press **Optns** and select **Trunked Mode**.





# Private, Phone, and PABX Calls

## NOTE

If you are in an on-going Group Call wish to make a new call, press  to ignore the current call. Dial the number.

## How to Dial

### Dialing via the Contact List

Due to limited keypad you can only use the contact list to select a number you previously stored. Press **Contcs** and search the stored number by scrolling (  or  ). If the contact has more than one number, use  /  to select the number.

## Private Call

A Private Call, also called Point-to-Point or individual call, is a call between two individuals. No other terminal can hear the conversation. This call can be:

- a Duplex call (if the system allows) in TMO, or
- a standard Simplex call in TMO or DMO.

## Making a Private Call

1. From the Contact List dial a number.

## NOTE

*In DMO the recipient you dial have to be on the same frequency and group.*



2. If Private is not the first type of call presented, press **CType** to select the Private Call type.
3. For a *Simplex* call, press and release the **PTT** button. You will hear a ringing tone. Wait for the called person to answer your call. Press and hold **PTT**. Wait for the talk permit tone (if configured) before talking, and release the **PTT** when listening.

For a *Duplex* call, press and release  . You will hear a ringing tone. Wait for the called person to answer your call.

- To end the call, press . If the called person ends the call, the **Call Ended** message is displayed.

**NOTE** *While Transmit Inhibit is activated, an incoming Private Call is indicated, but you cannot answer the call.*

## Receiving a Private Call

- The MTP850 Ex/MTP810 Ex switches to the incoming Private Call. The display shows the caller's identity.
- To answer an incoming *Simplex* call, press **PTT**. To answer an incoming *Duplex* call (indicated by **Spkr** or **Erpce** soft keys), press .
- To end the call, press .

**NOTE** *Your terminal can alert you of an incoming call. Select the alert settings in the Tones menu items.*

## Phone and PABX Calls

The **Phone Call** allows you to call a landline telephone number, a cellular mobile phone number or another terminal using ISDN number.

**NOTE** *Feature MS-ISDN enables the terminal to make and receive the calls from the phone using ISDN number.*

The **Private Automatic Branch Exchange (PABX) Call** allows you to call local (office) extension numbers. This type of call needs to be activated by your Service Provider.

In this publication we use “phone number” when referring to these numbers.

**NOTE** *While Transmit Inhibit is activated, an incoming Phone or PABX Call is indicated, but you cannot answer the call.*

## Making a Phone or PABX Call

- From the Contact List dial a number.
- If Phone or PABX are not the first type of call presented, press **CType** repeatedly to select the Phone or PABX call type.
- Proceed as for making and receiving Duplex Private Calls. If the user presses the PTT button it initiates a Simplex Phone Call.

# Emergency Mode

---

You can send and receive **Emergency Group** Calls in **Trunked Mode** or in **Direct Mode**. If your terminal is configured to operate through a gateway, Emergency calls can be placed through the gateway.

You can initiate an Emergency Group Call to and receive it from:

- selected group (TMO and DMO) (if tactical emergency)
- pre-defined group (if non-tactical emergency).

Contact your Service Provider to know which is the selected mode.

Your Service Provider will configure the Emergency Alarm and Hot Microphone features.

Emergency calls will be allocated emergency priority in the system.

## Entering or Exiting Emergency Mode

To enter Emergency Mode, press **and hold** the Emergency button at the top of the MTP850 Ex/MTP810 Ex.

**NOTE** *The required time you need to press the Emergency button is set to default to 0.5 seconds. The time can be configured by your Service Provider.*

**NOTE** *Pressing the Emergency button activates one or more services. Contact your Service Provider for more information.*

To exit Emergency Mode, press and hold **Exit**. Your terminal will switch to the Home display.

## Sending an Emergency Alarm

Your MTP850 Ex/MTP810 Ex will send an Emergency Alarm to the dispatcher (if configured by your Service Provider):

- Automatically, upon entering Emergency Mode.
- If you press the Emergency button again while the MTP850 Ex/MTP810 Ex is in Emergency Mode.

After sending the alarm, the display will show one of the following delivery reports:

- **Alarm Sent**
- **Alarm Failed**

In both cases, the display returns within a few seconds to the main screen of the Emergency Mode.

Due to no delivery confirmation in DMO, **Alarm Sent** information confirms only sending the alarm.

**NOTE** *The Emergency Alarm is a special status message sent to the dispatcher monitoring the selected group. This can be used in dispatch systems to highlight emergency calls.*

**NOTE** *Some systems do not support the Emergency Alarm feature when the user is in a "Local Area Service" area.*

**WARNING**

*Pressing the Emergency button, even if Transmit Inhibit is activated, causes the MTP850 Ex/MTP810 Ex to transmit immediately. The MTP850 Ex/MTP810 Ex must NOT be within the RF sensitive area when entering Emergency Mode.*

## Hot Microphone Feature

If the Hot Microphone feature was programmed into your MTP850 Ex/MTP810 Ex by your Service Provider, you can make an Emergency Group Call and talk to the dispatcher (and members of your group) without the need to press and hold the **PTT**.

The microphone will stay open for a time period (programmed by your Service Provider). The microphone will stay open until:

- the Hot microphone time period expires
- you press **PTT** during the Hot Microphone period
- you press the **End** key

At the end of the Hot Microphone the **Emgcy Mic Ended** message will be displayed and the MTP850 Ex/MTP810 Ex returns to the Emergency Mode. The Hot Microphone feature is disabled and PTT operation returns to normal.

If required you can resume Hot Microphone by pressing the Emergency button again.

**NOTE** *Hot Microphone feature is available TMO mode only.*

## Making an Emergency Group Call

To initiate or answer a call while in Emergency Mode:

- Press and hold **PTT**.
- Wait for the talk permit tone (if configured) and talk.
- Release **PTT** to listen.

## Silent Emergency Mode

**NOTE** *Silent Emergency Mode needs to be enabled by the Service Provider.*

To enter Silent Emergency Mode, press **Emergency button**.

Silent Emergency Mode provides no audible and visible indication. All of the key tones are switched off.

To exit Silent Emergency Mode, press both soft keys simultaneously.

## Man Down

You can enable the Man Down feature in case of entering any risky operation. It monitors the state in which the terminal is. The terminal alerts you when:

- Its tilt exceeds a predefined angle value.
- It remains static for a predefined period of time.

Press  and select **Man Down > On**. To disable the feature,

press  and select **Man Down > Off**.

## Call-Out

This feature allows the user to receive Call-Out alerts. When the Call-Out messages have been received by the radio, it interrupts current services and attends to the Call-Out alert without any further delay. After Call-Out alert has been cleared, the radio exits Call-Out mode and reverts back to normal mode. The user is able to receive only Emergency Calls during Call-Out mode. There are four types of the Call-Out alert:

- Normal Call-Out
- Storm plan – it is sent to a group several time to raise reliability. User can only accept the Call-Out by pressing any button and is moved to information phase (soft keys are not labelled).
- Fallback Mode – it includes only voice communication. It can be cleared manually



**NOTE** *Fallback is only possible when Radio is in Local Site Trunking.*

- Test Call-Out – dispatcher has the ability to test this feature. Radio is generating the tone with **Call-Out Test** on the display. Only one softkey is enabled **Test OK** to confirm and to clear the test.

### **Interactions when the user is in other mode**

- TXI Mode – users can read the message but they can not respond to it. They have an option to leave the TXI Mode by pressing soft key or reject the Call-Out message.
- DMO Mode – Call-Out is not supported.
- Emergency Mode – all the Call-out alerts are ignored.

### **Call-Out service phases**

- Alerting phase – user receives a Call-Out message. The alarm tone indicates that the message text is displayed. Under it there are three options for the user to pick: **Accept**, **Reject** or . If the user will accept the alert no other service from this point can interrupt.  key gives more choices.

**NOTE** *The user can stop the alert tone by pressing PTT or any of the soft keys.*

- Information phase – the user is still in the Call-Out mode and can receive more detail information about the incident that occurred via subsequent text or the voice message. The user can query for more information using voice group call or Call-Out text function which enables to send a text message to the Service Provider. User can always respond and send back the text or the voice message using voice group call.

### **Call-Out Box**

CO Box is giving the user the option to view and store the Call-Out messages for future reference.



To view them press  > **Messages > CO Box**.

- When the radio is in Call-Out Mode, you can only read the ongoing Call-Out messages.



# Messages

---

## Sending a Status Message



Select the desired group, then press  and select **Messages** > **Send Status**. Select status and press  or **PTT**.

## Sending a User-defined Message

Press  and select **Messages** > **Templates**. Scroll and choose your required template. Select **Send**, or press  or **PTT**. Select your mail recipient or enter number. Select **Send**, or press  or **PTT** to send the message.

**NOTE** *The message can be send to private, phone and a group number. Phone option needs to be enabled by your Service Provider.*

## Sending a Predefined Message

Press  and select **Messages** > **Predefined**. Scroll and choose your required template. Press  and select **Edit** to edit the message. Type required information. Select **Send**, or press  or **PTT** to send the message.

## Handling New Incoming Text Messages

Your MTP850 Ex/MTP810 Ex will alert you of an incoming message and enter the inbox automatically, if there is no on-going activity in the terminal.

Scroll to the message and select **Read** soft key. To read a long message, press **More** to read the next page and **Back** to return to the previous page.

Press  and select to store/delete/delete all/forward.



## Handling Unread (New) Messages

Press  and select **Messages > Inbox**. Scroll to the message and select **Read** soft key. To read a long message, press **More** to read the next page and **Back** to return to the previous page.

Press  and select to store/delete/delete all/forward.

### NOTE

*For Long Text Messages Reply, Store and Forward options are not available.*

# Tips & Tricks

---

## **Modeless Operation**

No need to select a mode (Group / Private / Phone) before initiating a call. Just dial a number and press **CType** (call type) soft key to

decide what call it is (then press **PTT** or ).

## **Home Key**

Not sure where you are? Want to get back to Home display?

Press .

## **Backlight Control**

You can either disable backlight (covered operation) or have it automatically turned on, by any key press.

You can also press the upper Side key - just to turn On/Off the backlight (if configured by your Service Provider).

## **One Touch**

Your Service Provider can program the two Side keys to many functions such as Flip Display, TMO to DMO switching and vice-versa, etc.

Press and hold the keys to see to which function they are programmed.

## **High/Low Audio Control**

You can control audio routing (speaker/earpiece) for any Simplex Private or Group Call via the dedicated Speaker Control key.

However, you can define via the menu to have all Group Calls in high audio (  > **Setup > Audio > Audio Toggle**).

## **Unified Contact List**

You can keep several numbers (Private, Mobile, Home, Work, PABX, Other) for the same person under the same contact name.

You can create up to 1000 contacts, and have a total of 1000 private numbers and 1000 phone numbers.

### **Text Size**

You can see the text on the display in two sizes: **Standard**, **Zoomed**, or **Extra Zoomed** (  > **Setup > Display > Text Size**).

### **Group Capacity**

Your Service provider can program up to 2048 groups for Trunked Mode, and up to 1024 groups for Direct Mode.

### **Flexible Folders**

You can ask your Service Provider to define how many groups will be in each folder (up to 256 folders).

### **“My Groups” Folder**

You can select any group (TMO or DMO) and add it to your personal folder.

In the Home display, press  to quickly access your “My Groups” folder.

### **Options (in the Home Display)**

You can easily change folder, select groups, switch between TMO and DMO (and vice-versa), and other functions via the Home display Options.

### **Easy Navigation while in Menu**

When scrolling up/down menu items, try also right/left scrolling. (This will select the item or return to previous level.)

### **Flipped Display On/Off**



When this feature is activated, the contents of the display are flipped upside down. This feature is particularly useful if you have to wear the MTP850 Ex/MTP810 Ex on the shoulder, belt, or lapel and at the same time wish to read the display upside down.

To activate/deactivate, press  and select **Setup > Display > Flip Display**. Or press and hold the pre-programmed one-touch button.

### ***Dialed Call List - Quick Access***

From the Home display press  to access the list of the last dialed calls.

### ***Automatic Scrolling via Navigation Key***



In a list press and hold  or  for automatic scrolling.

### ***Recent Calls Menu - Quick Access***

From the Home display press .

### ***Setting Time & Date***

Time and date are synchronized by the infrastructure. When not within the infrastructure signal range you can set the values manually.

- To set time press  and select **Setup > Time&Date > Set > Set Time**. Enter time using navigation key.
- To set date press  and select **Setup > Time&Date > Set > Set Date**. Enter date using navigation key.



## MTP850 Ex/ MTP810 Ex



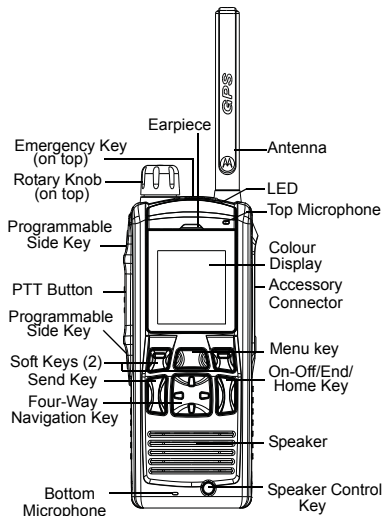



### Quick Reference Guide



### Turning MTP850 Ex/MTP810 Ex On/Off

To power the MTP850 Ex/MTP810 Ex on/off, press and hold .

### Using MTP850 Ex/MTP810 Ex Menu System

- To enter the menu, press .
- To scroll through the menu, press  or .
- To select a menu item, press **Select** soft key or .
- To return to previous level, press **Back** or .
- To exit the menu items, press .

### Selecting Trunked/Direct Mode Operation

- Your terminal may be configured with a One-touch button to switch between TMO/DMO. Contact your Service Provider for more information.
- From the Home display press **Optns**, select **Trunked Mode** or **Direct Mode**.

### Making a TMO Group Call

From the Home display navigate to the desired group. Press **Select** soft key (if configured). Press and hold **PTT**. Wait for the talk permit tone (if configured) and talk. Release **PTT** to listen.

### Making a DMO Group Call

Enter DMO. Navigate to the desired group. Press **Select** soft key (if configured). Press and hold **PTT**. Wait for the talk permit tone (if configured) and talk. Release **PTT** to listen.

### Making TMO Emergency Group Call

Enter TMO. Press and hold the Emergency button. Emergency alarm is sent automatically. Press and hold **PTT**. Wait for the talk permit tone (if configured) and talk. Release **PTT** to listen. If using "Hot Mic" feature, wait for the **Emgncy Mic On** message to appear on the display and talk without pressing **PTT**.

To exit Emergency Mode, press and hold **Exit** soft key.

### Making DMO Emergency Group Call

Enter DMO. Press and hold the Emergency button. Press and hold **PTT**. Wait for the talk permit tone (if configured) and talk. Release **PTT** to listen. To exit Emergency Mode press and hold **Exit** soft key.



### Making TMO Simplex Private Call

From the Home display dial a number. Press **CType** to select the call type. Press and release **PTT**. Ringing sounds. Called party answers. Wait for the called party to finish speaking. Press and hold **PTT**. Wait for the talk permit tone (if configured) and talk. Release **PTT** to listen. Press  to terminate call.

### Making DMO Simplex Private Call

Enter DMO. From the Home display dial a number. Press and hold **PTT**. Wait for the talk permit tone (if configured) and talk. Release **PTT** to listen. Press  to terminate call.



### Making Duplex Private Call/Phone/PABX Call

From the Home display dial a number. Press **CType** to select the call type. Press and release . Ringing sounds. Called party answers. Press  to terminate call.

### Answering Call

Your MTP850 Ex/MTP810 Ex switches to the incoming call and alerts you of the incoming call. To answer the call, press  for Phone/PABX/Duplex Private calls or press **PTT** for all other calls.

### Sending Status Message

Select the desired group, then press  and select **Messages > Send Status**. Select status and press  or **PTT**.

### Tips & Tricks

#### • Home Key

Not sure where you are? Want to get back to Home display? Press .

#### • Backlight Control

You can either disable backlight (covered operation) or have it automatically turned on, by any key press.

You can also press the upper Side key - just to turn On/Off the backlight (if configured).

#### • High/Low Audio Control

You can control audio routing (speaker / earpiece) for any Simplex Private or Group Call via the dedicated speaker control key.

However, you can define via the menu to have all Group calls in high audio

(  > **Setup > Audio > Audio Toggle**).

#### • Unified Contact List

You can keep several numbers (Private, Mobile, Home, Work, PABX, Other) for the same person under the same contact name.

#### • Text Size

You can see the text on the display in three sizes: **Standard**, **Zoomed**, or **Extra Zoomed** (  > **Setup > Display > Text Size**).

#### • “My Groups” Folder

You can select any group (TMO or DMO) and add it to your personal folder.

In the Home display, press  to quickly access your “My Groups” folder.

#### • Man Down

You can enable the Man Down feature in case of entering any risky operation.

Select  > **Man Down > On**.

To disable the feature, press  and select **Man Down > Off**.





EN



**MOTOROLA**

[www.motorola.com/tetra](http://www.motorola.com/tetra)

68015000131-A

