



***MTM800***  
***TETRA 摩托车对讲机***  
***基本用户手册***



6815598H01-U



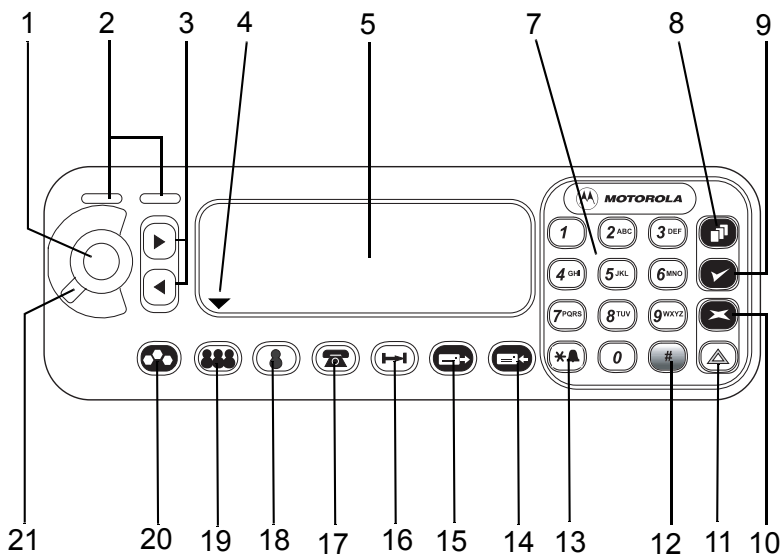

# 目录

安全信息 .....	3
废弃处理信息 .....	3
版权信息 .....	3
图标约定 .....	4
<b>MTM800 概述 .....</b>	<b>5</b>
控制键和指示灯 .....	5
音频信号音 .....	7
周期性警报 .....	9
按键和按钮概述 .....	10
模式键 .....	10
菜单键 .....	10
紧急键 .....	10
功能键 .....	10
激光二极管指示灯 .....	12
进入菜单选项 .....	12
退出菜单选项 .....	12
菜单选项列表 .....	13
显示屏 .....	15
显示屏图标 .....	15
显示长号码或短消息 .....	16
<b>开始 .....</b>	<b>17</b>
打开/关闭 MTM800（开/关按钮） .....	17
打开 MTM800（点火感应器） .....	17
打开 MTM800（外部紧急开关） .....	17
禁止传输情况下开机 .....	17
拆卸对讲机 .....	18
解除 MTM800 锁定 .....	18
<b>选择 TMO 或 DMO 操作 .....</b>	<b>19</b>
进入 TMO 或 DMO 模式 .....	19
呼叫（集群模式操作） .....	19
TMO 组呼 .....	19
发起 TMO 组呼 .....	19
接收 TMO 组呼 .....	20
接收 TMO 广播呼叫 .....	20

呼叫（直通模式操作）	20
DMO 组呼	20
发起 DMO 组呼	21
接收 DMO 组呼	21
退出 DMO 模式	21
呼叫（个呼和电话呼叫）	<b>22</b>
个呼	22
发起个呼模式呼叫	22
接收个呼模式呼叫	22
电话及专用自动交换分机呼叫	23
发起电话或 PABX 呼叫	23
VOX 控制	23
<b>紧急模式</b>	<b>24</b>
进入或退出紧急模式 (TMO & DMO)	24
隐形紧急模式	24
发送紧急告警	25
紧急麦克风功能	26
发起紧急组呼	26
<b>短消息</b>	<b>27</b>
发送状态信息	27
发送新的短消息	27
发送用户定义的短消息	27
发送预定义短消息	27
处理新文本短消息	27
处理旧文本短消息	27
<b>快速参考指南</b>	<b>29</b>

MOTOROLA 和 M 格式商标均为美国专利商标局注册商标。所有的产品或服务名字是该所有者的物产。

© 2006 – 2008 摩托罗拉公司  
版权所有。

	<b>小心</b>	<p>在使用这些产品之前，请仔细阅读 <b>MTM800</b> 随机附带的产品安全和射频辐射手册 <b>6804113J25</b> 中关于安全使用对讲机的操作说明。</p>
---	-----------	--

这些附件仅限于能够满足 ICNIRP 射频能量辐射要求的职业应用。在使用这些产品之前，请仔细阅读随机附带的产品安全和射频辐射手册中有关的射频能量信息和安全操作说明（摩托罗拉出版物备件号 **6804113J25**），以确保符合射频能量辐射限制标准。

请将本用户手册和产品安全及射频辐射小册子保存好，当附件转交给其他操作员时，可供他们参阅。

## 废弃处理信息



**欧盟废弃电子电气设备 (WEEE)** 指令要求销售到欧盟成员国的产品必须在产品上（有时是在包装上）张贴带交叉符的垃圾箱标签。根据 WEEE 指令的定义，此垃圾箱符号表示欧盟成员国的客户和终端用户不得将此电子电气设备作为生活垃圾处置。

欧盟成员国的客户或最终用户应联系当地的设备供应商代表或服务中心，以了解有关各国废物收集系统的信息。

## 版权信息

本手册所介绍的产品可能包括储存于半导体存储器或其它媒体中的有版权的电脑程序。美国和其他国家的法律保护摩托罗拉公司的某些有版权的电脑程序的专有权利，其中包括以任何形式拷贝或复制有版权的电脑程序的权利。因此，本手册所介绍的摩托罗拉产品所包含的任何有版权的摩托罗拉电脑程序，在未经摩托罗拉书面允许的情况下，不允许进行任何形式的拷贝、修改、反向工程或分发。除此之外，购买这些产品将不被认为拥有直接或暗示的版权人之版权、专利或专利使用的任何许可证授权，产品销售过程中法律运用所引起的普通非专有性免税许可证除外。

此文档受版权保护。出于使用摩托罗拉产品的目的，允许在适当条件下复制此文档。不允许出于其他目的对此文档进行复制、变更、补充或其他方式的处理。只有此电子文档才是原始文档。复制文档仅为副本文档。摩托罗拉集团公司不保证这些副本文档的正确性。

## 图标约定

本文档集可以为读者提供更多的直观提示。整个文档集中使用了以下图标。这些图标及它们各自的说明如下所述。



警告

带有相应安全图标的信号词“警告”表示，如果不注意其中的信息，则可能导致死亡或严重的人身伤害和产品损坏。



小心

带安全图标的信号词“小心”表示，如果不注意其中的信息，则可能导致轻伤或中度的伤害，或者严重的产品损坏。

小心

在无安全图标时，该信号词小心可用于声明与本产品无关的潜在损坏或伤害。

注意

“注意”含有比周围文字更重要的信息，如例外或注意事项。它们通常为读者提供一些补充参考信息，提醒读者如何操作（例如当其不是当前过程的一部分时），或者告诉读者屏幕中某些项目的位置。“注意”没有相应的警告级别。

# MTM800 概述

## 控制键和指示灯

此处编号指内侧封面中示意图上的编号。

编号	说明
1	开/关键 用来打开/关闭（按住）MTM800。
2	LED（指示灯）
3	浏览按键 按向左或向右按钮以便在菜单中滚动列表或者用于编辑字母数字。
4	显示箭头 显示当前模式。
5	字母和数字显示屏 提供两行 14 字符的显示，带背光。
7	字母和数字键盘 使用此键盘输入字母数字字符用于拨号、输入地址簿和文本短信息。
8	菜单键 用来进入主菜单和滚动菜单选项。
9	选择键
10	取消键
11	紧急键 用于发送紧急告警（按住）。
12	背景灯按键 使对讲机的背景灯变暗或变亮。
13	外部报警键 用来启动或关闭外部报警（声光）。
14	短消息邮件键 选择操作的短消息邮件模式。
15	状态模式键 选择操作的发送状态模式。

编号	说明
16	直通模式键 进入/退出直通模式操作。
17	电话模式键 选择操作的电话/PABX 呼叫模式。
18	个呼模式键 选择操作的个呼模式。
19	组呼键 选择操作的组呼模式。
20	范围键 选择通话组范围或 DMO 网关。
21	音量旋钮 调整音量。
	通话键 (PTT) 按住此按键讲话（发送）；释放此按键接听。

**注意**

在第一次使用你的 MTM800 之前，除去显示屏上的透镜保护塑胶。









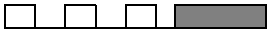

# 音频信号音

□ = 高音； ■ = 低音；

说明	类型	重复次数
<b>空闲</b>		
<ul style="list-style-type: none"> <li>返回初始屏幕</li> <li>当旋转计时器超过时返回到旋转音量模式</li> <li>返回覆盖范围</li> <li>返回全服务状态</li> </ul>		一次
可以发送		一次
按键无效		一次
<ul style="list-style-type: none"> <li>按键有效</li> <li>MTM800 开机时自检失败</li> <li>从“不在服务区”状态变为“在服务区”状态</li> </ul>		一次
<b>来电</b>		
呼叫清除告警音		一次
呼叫等待提示音，表示电话或个呼正被挂起		每隔六秒钟重复一次，直到呼叫终止。
数据已连接或数据已断开		一次
您一按 PTT 键会听到通话允许音。		一次（正常提示音）
		一次（短提示音）
您一按下 PTT 键就会听到不通过网关的通话允许音。该提示音表示网关不再可用。		两次
		一次

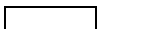
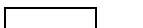
说明	类型	重复次数
<ul style="list-style-type: none"> <li>• 通话禁止</li> <li>• 系统忙</li> <li>• 限时器超时</li> <li>• 被叫对讲机不可用或正忙</li> </ul>		直到您松开 PTT 键为止
<ul style="list-style-type: none"> <li>• 因为网络原因呼叫被断开或失败</li> <li>• 拨叫号码错误</li> </ul>		一次 无提示音
DMO (直通模式) 进入		一次
退出 DMO 模式		一次
本站集群 — 进入/退出		一次
电话呼叫的振铃回音 (发送)		每隔三秒重复一次，直到被叫用户应答或拒绝呼叫。
电话忙		每隔 0.5 秒重复一次
状态短消息已发送给调度员或失败		两次
<b>有呼叫正在呼入</b>		
状态信息已被调度员确认		四次
您的 MTM800 不通过网关 (需设置) 接收到组呼		一次
接收到高优先级的组呼		一次
发送或接收到紧急告警		两次
紧急告警失败		四次
接收到紧急呼叫		一次

说明	类型	重复次数
电话振铃，全双工单呼（接收）	按照铃音类型子菜单设置。	直到您应答或拒绝呼叫为止
接收到个呼	按照铃音类型子菜单设置。	直到您应答或拒绝呼叫为止
个呼主叫方的振铃		直到呼叫被应答为止
半双工私密先占式优先权呼叫 (PPC) 振铃		每四秒钟重复一次，直到呼叫被应答或拒绝。
全双工私密 PPC 振铃		每隔四秒钟重复一次，直到呼叫被应答或拒绝。
有限的服务		当进入有限的服务状态时发出一声提示音。
接收到新邮件		一次
新组呼		一次
<b>电池/一般</b>		
音量设置（耳机、键盘，扬声器）		连续不断
音量设置（振铃）		当设置音量时。
禁止传输 (TXI)		一次

## 周期性警报





用户可以禁用/启动此功能。

按“ - 4 设置 - 1 提示音 - 5 周期性警报”也可以设置两次警报之间的时间周期。

## 按键和按钮概述

### 模式键

当工作于集群模式 (TMO) 时，MTM800 有四个主要的呼叫模式：

- 组呼模式 – 发送和接收组呼：按 
- 个呼模式 – 发送和接收个呼模式呼叫：按 
- 电话模式 – 发送和接收电话呼叫：按  1
- PABX 模式 – 发送和接收来自本地分机号码（交换局）的呼叫：  
按  2。

当几秒钟之内没有任何活动时，您的 MTM800 将返回组呼模式（默认模式）。

### 菜单键

按  进入菜单。MTM800 菜单允许您控制您的 MTM800 设置。

### 紧急键

在任何模式下按住  进入紧急模式。

#### 注意

*您按紧急键所需的缺省设置时间是 2 秒。此时间可以设置，但只能由您的服务提供商设置。*

### 功能键

#### 数字键

MTM800 支持单键的功能可让您选择或激活常用的功能。您只要按下和按住数码键即可激活单键功能。

#### 单键个呼

如果运营商进行了相应设置，则 MTM800 支持单键个呼功能。用户可按下指定按钮拨打上一个组呼发起人号码。













#### 注意

*您按数字键以激活单键功能所需的默认时间为 1 秒。此时间可以设置，但只能由您的服务提供商设置。*

#### 注意

*有关为每个数字键指定功能的详细信息，请咨询您的服务提供商。*

可用字符列表:

键	字母数字模式
	.,?!01@'"/:~^` _+&%x*=<>€£\$¥¤□[] { } \ ~ ^ `   _ ; + & % x * = < > € £ \$ ¥ ¢ [ ]
	A B C 2 a b c 2
	D E F 3 d e f 3
	G H I 4 g h i 4
	J K L 5 j k l 5
	M N O 6 m n o 6
	P Q R S 7 p q r s 7
	T U V 8 t u v 8
	W X Y Z 9 w x y z 9
	空格 * / %
	0 + -
	# = < >

## 激光二极管指示灯

激光二极管指示灯能说明您的 MTM800 所处的工作状态。

指示灯	状态
绿灯常亮	正在使用
闪烁的绿灯	在系统覆盖范围内
红灯常亮	不在系统覆盖范围内
红灯常亮	对讲机在开机时正在连接网络/进入 DMO
黄灯持续亮	禁止传输 (TXI) 正在使用/ 在 DMO 中信道忙
先保持亮着, 然后 闪烁为橙色	有呼叫正在呼入
没有指示灯显示	关机状态

## 进入菜单选项

1. 从任何模式, 按 .
2. 要滚动到所需的选项, 按  选择。
3. 您也可以输入所需选项的号码键。  
例如, 您可以按 “2 2 4 ” 进入 “4 内存状态”。

## 退出菜单选项

按 .

**注意**

如果经过一段时间后未检测到任何活动, 您的 MTM800 将会退出。

# 菜单选项列表

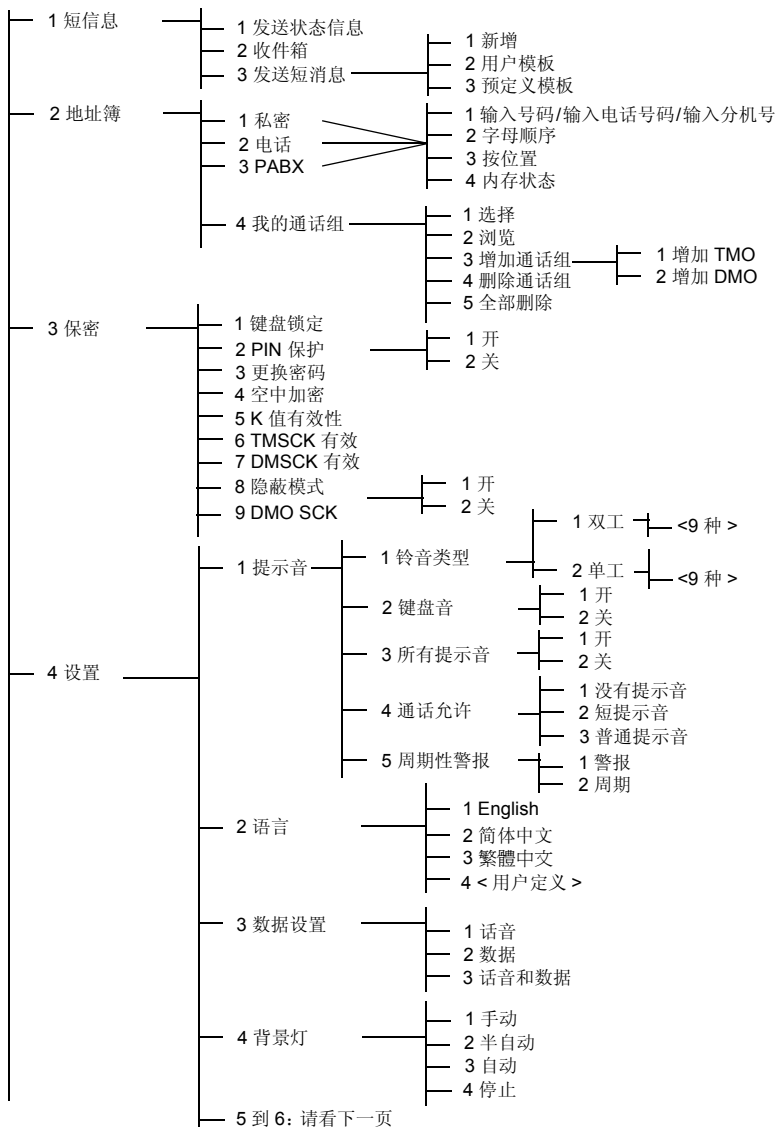

## 菜单选项列表 (续)

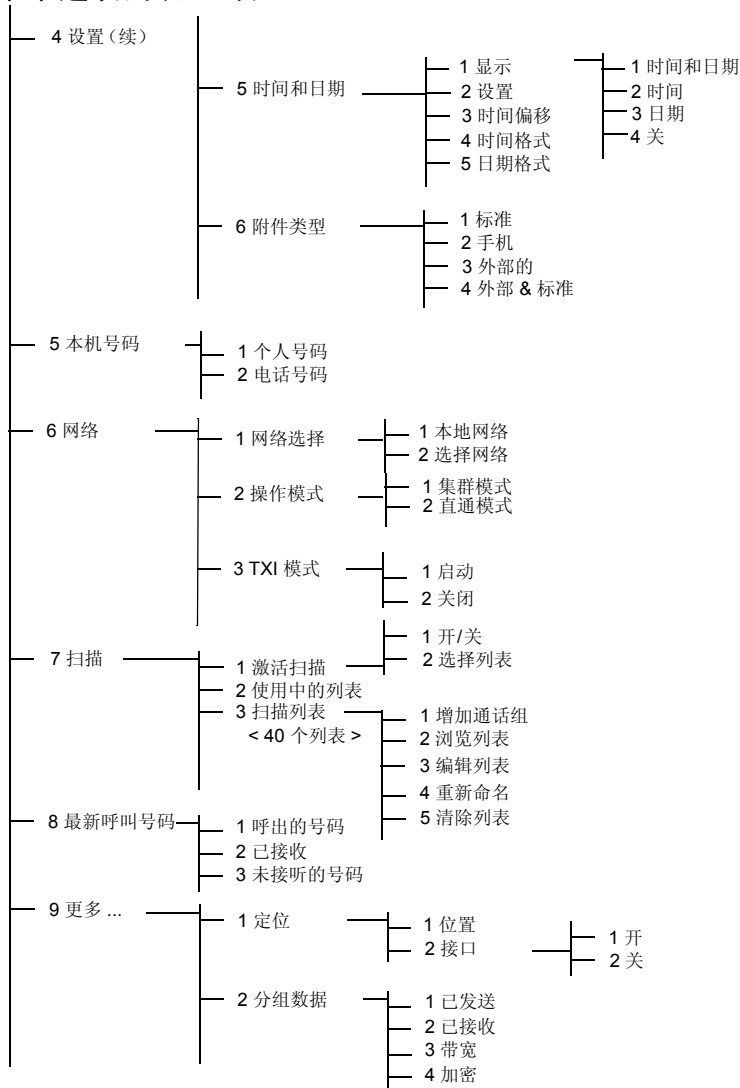







## 注意

某些选项有可能被运营商激活或关闭，从而导致菜单列表中的有些菜单号码有可能会有所不同。

## 显示屏



## 显示屏图标

在您打开 MTM800 之后，在显示屏的上方将显示出各种图标，用以代表如下情形：

显示屏图标	说明
<b>集群模式操作</b>	
	<b>信号强度 (TMO)</b> 允许您检查信号的强度。信号条越多表示信号越强。
	<b>优先级扫描</b> 表示 MTM800 中的优先级扫描功能已被激活。
	<b>连接了数据终端</b> 当 MTM800 已成功连接到外设并准备传送数据时显示。
	<b>数据发送/接收</b> 当 MTM800 正在发送数据到外设（膝上型或台式电脑）、或者从这些设备接收数据时显示此图标。
<b>直通模式操作</b>	
	<b>信号强度 (DMO)</b> 表示一个呼入的直通模式组呼。
	<b>直通模式</b> 当 MTM800 进入直通模式时显示此图标。

显示屏图标	说明
	<p><b>DMO 网关</b></p> <p>表示已选择网关。本图标有三个状态：  <b>保持亮着</b> — 当对讲机 MTM800 与网关同步时。  <b>闪烁</b> — 当对讲机 MTM800 未同步或者在连接时。  <b>无图标</b> — 在进行用户机到用户机和转发呼叫时。</p>
	<p><b>DMO 转发器</b></p> <p>当在 DMO 中选择了转发器选项时显示。本图标有三个状态：  <b>保持亮着</b> — 当对讲机检测到转发器时（例如接收一个存在的有效信号时）。  <b>闪烁</b> — 当对讲机未检测到转发器或者在连接时。  <b>无图标</b> — 在进行用户机到用户机和网关呼叫时。</p>
<b>一般图标</b>	
	<p><b>未读短信</b></p> <p>说明在您的收件箱中有未读的短消息。</p>
	<p><b>新短消息到达</b></p> <p>因为您正在进行呼叫，您的收件箱不能打开短消息。此图标会一直显示在显示屏上，以提醒您在您的收件箱中有新的短消息到达。</p>
	<p><b>正在紧急模式中</b></p> <p>当 MTM800 工作于紧急模式时，图标会出现。</p>

## 显示长号码或短消息

数字后面的三个小点表明短消息继续在下页。按  阅读下一“文本”页，按  返回前一页。

# 开始

## 打开/关闭 MTM800（开/关按钮）

如要开机，按住开 / 关按钮。您的 MTM800 会进行自检和登记注册例行程序。在成功的登记注册之后，MTM800 将进入工作状态。

如要关机，按住开 / 关按钮。您将听到一声提示蜂鸣音，屏幕上显示“关机”。

## 打开 MTM800（点火感应器）

如果 MTM800 使用点火传感器进行配置，则只要车辆点火此对讲机就会自动打开。

## 打开 MTM800（外部紧急开关）

如果连接了外部紧急开关，并且 MTM800 关机，则按紧急开关就可将其打开。MTM800 将会在紧急模式下开机。

## 禁止传输情况下开机

开机时 TXI 模式停留在启动状态下。

您会被询问是否要让 TXI 停留在打开模式。



**警告**

在关闭禁止传输前确保您已离开限制区域。

选择“**1 退出 TXI**”关闭 TXI 模式。如果 MTM800 之前被使用在集群模式 (TMO) 下，它将入网登记。如果 MTM800 之前使用在直通模式下，它将会保持在直通模式下。

在集群模式下选择“**2 继续留在 TXI**”，MTM800 关闭；在 DMO 模式下选择“**2 继续留在 TXI**”，您将停留在 DMO 模式下，且 TXI 被选中。

## 拆卸对讲机



小心

### 选项 1:

从对讲机断开 13.2V 主电源之前:

1. 关闭对讲机。
  2. 松开对讲机关闭按键后等待最少 4 秒钟。
- 断开 13.2V 主电源。

### 选项 2:

不关闭对讲机，直接断开主电源。

## 解除 MTM800 锁定



您的 MTM800 在开机时有可能是锁住的。

要在开机后解锁 MTM800，根据提示输入密码。MTM800 进入缺省的初始模式。

## 选择 TMO 或 DMO 操作

### 进入 TMO 或 DMO 模式

通过以下方式之一进入 TMO 或 DMO：

- 如果 MTM800 处于 DMO 模式下，按住  (TMO)。
- 如果 MTM800 处于 TMO 模式下，按住  (DMO)。







### 呼叫（集群模式操作）

#### TMO 组呼

组呼是您和同一通话组中其他人员之间的一种通信方式。通话组是预先定义的一组用户，用户可以加入和/或请求一个组呼。

通话组被分成数个范围。每个范围可以包含数个通话组。

#### 发起 TMO 组呼

1. 按 。
2. 如果这就是所需的通话组和范围，请按住 **PTT** 键。等听到通话允许音后再对麦克风讲话。  
松开 **PTT** 键接听。
3. 如果您想呼叫与屏幕所示的通话组不同的另一个通话组，按  或  在通话组中滚动。
4. 要选择一个未显示的范围，按 ，选择“范围”选项，使用  或  进行滚动。按  确认您的选择（或者按 **PTT** 在新的范围内发起呼叫）。

当您发起一个呼叫时，选定通话组中已经开机的所有组员将会收到您的呼叫。

#### 注意

当您超出了所选定的通话组正常覆盖范围，则会显示“没有通话组”信息。然后您必须选择在您的工作范围内有效的其他通话组。

## 接收 TMO 组呼

除非 MTM800 正在进行通话，否则它将自动切换到组呼模式并接收此呼叫。要应答该呼叫，请按住 **PTT** 键。

您的 MTM800 将显示通话组名和呼叫方的个人号码或姓名（别名）（如果以前存储在您的号码簿中）。

**注意** 有关呼叫提示的信息，请参阅“提示音”菜单选项中的设置。

**注意** 当接收一个组呼时，您将听到一声“新组呼”的提示音。

## 接收 TMO 广播呼叫

广播呼叫（又称作调度员呼叫）是由主控台操作员（调度员）发出给所有用户的高优先级组呼。MTM800 是配置来监听广播呼叫的，但是用户不能对讲。

如果该组呼的优先级是相等（或较低），广播呼叫会先占据一个正在进行中的组呼。

## 呼叫（直通模式操作）

### DMO 组呼

在直通模式 (DMO) 下，MTM800 可以在没有系统覆盖的情况下使用。直通模式使得您与其他同样处于直通模式的对讲机通话，这些对讲机与您的 MTM800 应当属于同一通话组并使用相同的频率。

**注意** 在 DMO 下只可进行以下三种呼叫：组呼、紧急组呼和半双工个呼。

您可以从选定的通话组或开放小组接收呼叫。（开放小组是属于所有 DMO 组的超级通话组）。

当您发起一个呼叫时，选定通话组中已经开机的组员将会收到您的呼叫。

如果 MTM800 的网关选项被激活，在 DMO 模式下 MTM800 便可与集群系统通信（反之亦然）。

## 发起 DMO 组呼

1. 通过菜单选择“直通模式”选项进入直通模式。
2. 如果这就是所需的通话组和范围，请按住 **PTT** 键。等听到通话允许音后再对麦克风讲话。  
松开 **PTT** 键接听。

## 接收 DMO 组呼

只有当您的 MTM800 处于 DMO 模式时，您才可以接收 DMO 组呼。  
您的 MTM800 会显示呼叫方的个人号码或别名和通话组名称。

## 退出 DMO 模式

要退出 DMO，选择 MTM800 要工作的操作模式。

# 呼叫（个呼和电话呼叫）



## 个呼

个呼模式呼叫，亦被称为点对点或个人呼叫，是一个发生在两个个人用户之间的呼叫通信。其它对讲机都不能听到他们的对话。

此呼叫可以是：

- TMO 模式下的全双工呼叫（如果系统允许）。
- TMO 或 DMO 模式下的标准半双工呼叫。

## 发起个呼模式呼叫

1. 要进入个呼模式，按 。
2. 输入您要呼叫的呼叫方号码。
3. 按下 **PTT** 键后再松开。您将听见振铃音。等待被叫方应答您的呼叫。
4. 按住 **PTT** 键。等待通话允许音（如已配置）然后讲话，释放 **PTT** 键接听。
5. 要结束呼叫时，请按 。如果被叫方结束通话，屏幕显示“呼叫结束”消息。

### 注意

当激活禁止传输功能时，会指示有个呼呼入，但不能应答此呼入。



## 接收个呼模式呼叫

如果运营商将 MTM800 设置为自动切换模式：

1. MTM800 将自动切换至个呼模式。显示屏上将显示主叫方的识别码。
2. 请按 **PTT** 键应答呼入。
3. 要结束呼叫时，请按 。屏幕会自动返回到接收呼入前的模式。



如果运营商将 MTM800 设置为手动切换模式：

1. 如果 MTM800 没有处于个呼模式，则个呼显示箭头开始闪烁。屏幕会返回到接收呼入前的模式。
2. 要应答此呼叫，按 ，然后按 PTT 键。
3. 要结束呼叫时，请按 。

如果被叫方结束通话，屏幕显示“呼叫结束”消息。

**注意**

有关呼叫提示的信息，请参阅“提示音”菜单选项中的设置。

## 电话及专用自动交换分机呼叫

电话模式可以让您呼叫固定电话号码或移动电话号码。在本手册中我们用“电话号码”来指代这些电话号码。

专用自动交换分机 (PABX) 模式允许您呼叫本地的（交换局）分机号码。此模式需要由您的服务提供商启动。

这两种模式都有相同的拨号特点。

**注意**

当激活禁止传输功能时，会指示有电话呼入或 PABX 呼叫，但不能应答此呼入。

## 发起电话或 PABX 呼叫

1. 按 ，然后选择“1 电话”或“2 PABX”。
2. 此时发起或接收个人电话呼叫。

## VOX 控制

VOX（声控传输）允许用户在免提模式下发送语音。使用手持式麦克风进行全双工个呼和电话呼叫时，对讲机会自动检测音频。

**注意**

此功能只有在您的运营商为您设置后才能使用。此功能禁用时，按 PTT 后可以发送语音。

# 紧急模式

您可以在**集群模式 (TMO)** 下或者在**直通模式 (DMO)** 下发送和接收紧急组呼。如果您的对讲机配置为通过网关进行操作，您就可以通过网关发起紧急呼叫。

您可以向选定的通话组发出紧急组呼，或者从该通话组接收紧急组呼（**TMO** 和 **DMO**）。

您的运营商会为您配置紧急报警和紧急麦克风功能。

紧急呼叫会向系统取得紧急优先权。

## 进入或退出紧急模式 (TMO & DMO)

要从任何其它模式进入紧急模式，请按住紧急键 。

### 注意

*您按紧急键所需的缺省设置时间是 2 秒。该时段可以由您的运营商为您设置。*

### 注意

*有关呼叫提示的信息，请参阅“提示音”菜单选项中的设置。*

按住  可退出紧急模式。您将进入普通通话组模式。

## 隐形紧急模式

如果您的运营商启动了隐形紧急模式，会在紧急模式下禁用所有音频与视频指示。

### 注意

*此功能仅对紧急个呼例外。*

## 发送紧急告警

当处于紧急模式时，您的 MTM800 会自动发送紧急告警。紧急告警在以下情况下发送：

- 在进入紧急模式时将自动发送。
- 当 MTM800 处于紧急模式时如果您按 。

发送告警后，屏幕将显示以下两种提示信息之一：

- 已发送警报
- 警报发送失败

在这两种情况下，显示屏在数秒钟之内就会回到紧急模式的主屏幕。

由于 DMO 下没有提交确认，发送警报只有“已发送警报”信息。

### 注意

紧急告警是一种特殊的状态短消息，它发送给监听选定通话组的调度员。它可用于调度系统中，以突出紧急呼叫。

### 注意

当用户处在“单站集群服务”区域内时，有些系统是不支持紧急告警功能的。



### 警告

如果禁止传输被启动时按紧急键，则 MTM800 会立刻发出呼叫。进入紧急模式时，MTM800 一定不能处于射频敏感地区。

## 紧急麦克风功能

如果运营商将紧急麦克风功能预先设定在您的 MTM800 中，您不需要按住 **PTT** 键也可以发出紧急组呼。

麦克风保持打开的时间是由运营商设定的。麦克风将一直打开，直到：

- 超过紧急麦克风时间
- 您在紧急麦克风时间内按 **PTT**
- 您按结束键

在紧急麦克风时间结束后，屏幕中显示“**紧急麦克结束**”信息，**MTM800** 返回到紧急模式。此时，紧急麦克风功能关闭，**PTT** 键操作返回正常。

如果需要，您可以再次按紧急键恢复紧急麦克风。

## 发起紧急组呼

- 启动紧急麦克风 – 要发起一个紧急组呼，按住紧急键。
- 停用紧急麦克风 – 要发起一个紧急组呼，按住紧急键。当屏幕显示改变为紧急组呼时，按住通话键 (**PTT**) 等待呼叫允许音（如果进行了配置）并开始讲话。松开通话键 (**PTT**) 接听。

## 短消息

### 发送状态信息

选择所需的通话组，然后按“ - 1 短消息 - 1 发送状态信息 - 确定”。选择状态并按 **PTT** 键发送状态信息。

### 发送新的短消息

按“ - 1 短消息 - 3 发送短消息 - 1 新增 - 确定”。写入您的短消息。按“选项”并选择“发送”。选择您的收件人或输入号码。按 **PTT** 键即可发送新短消息。

### 发送用户定义的短消息

按“ - 1 短消息 - 3 发送短消息 - 2 模板 - 确定”。滚动并选择您所需的模板。按“选项”并选择“发送”。选择您的收件人或输入号码。按 **PTT** 键即可发送短消息。

### 发送预定义短消息

按“ - 1 短消息 - 3 发送短消息 - 3 预定义模板 - 确定”。滚动并选择您所需的模板。按“更改”以更改短消息。输入所需的信息。按 **PTT** 键即可发送短消息。

### 处理新文本短消息

屏幕上将闪烁  图标。

要进入收件箱，按“ - 1 短消息 - 2 收件箱 - 确定”。滚动到该短消息并选择“阅读”软键。要阅读长信息，按“更多”可以阅读下一页，按“退出”可以返回上一页。

### 处理旧文本短消息

按“ - 1 短消息 - 2 收件箱 - 确定”。滚屏至消息并选择“选项”。您可以选择相应的选项阅读短消息，或者删除一条或全部短消息。

## 备注



# MTM800

## 摩托车对讲机

### 快速参考指南

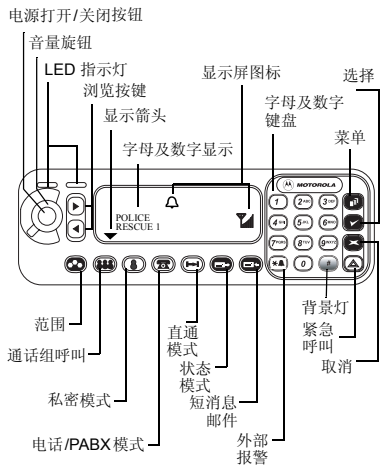

#### 发起电话/PABX 呼叫

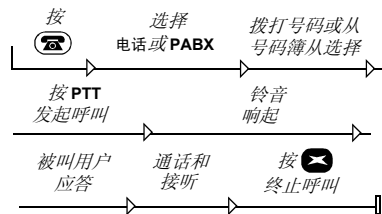

#### 发起 TMO 个呼模式呼叫

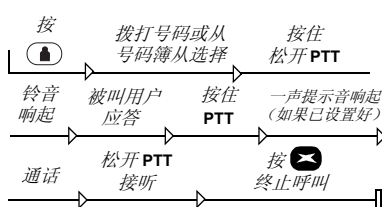

#### 发起 TMO 全双工个呼模式呼叫

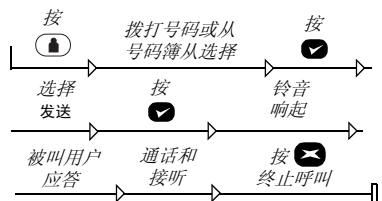

#### 发起 DMO 个呼模式呼叫

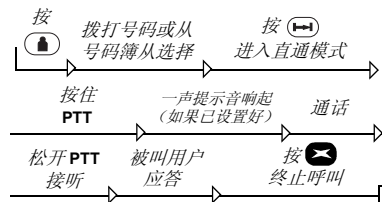

#### 发起 TMO 或 DMO 组呼

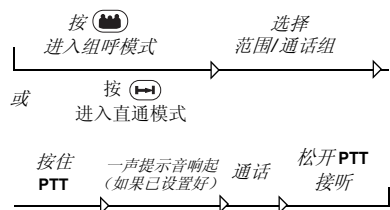

### 发起紧急组呼（在 TMO 模式）

按住 。此时将自动发送紧急告警。

当处在紧急模式时，按住 **PTT** 讲话。如果使用紧急麦克风功能，等到显示“紧急麦克风打开”信息，并且不需按下 **PTT** 就可以讲话。

按住 可退出紧急模式。

### 应答呼叫

您的 MTM800 切换到呼入的模式，然后开始振铃。请按 **PTT** 键应答呼入。

### 发送状态信息 短消息

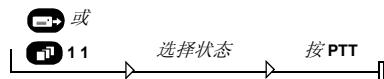

### 发送新的短消息



### 发送用户定义的短消息

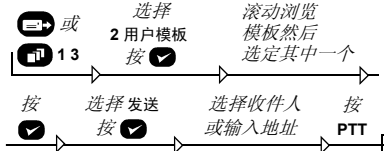

### 发送预定义短消息

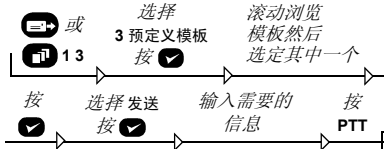

### 处理新文本短消息

屏幕中的 图标将闪烁，同时 MTM800 发出一声提示音。有关详情，请参阅用户手册中的菜单信息部分的内容。

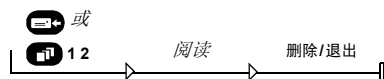

### 处理旧文本短消息

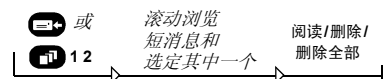

### 重拨上次呼叫号码

按 **PTT** 键呼叫上次呼叫的号码。

### 使用菜单

- 进入菜单：按 。
- 滚动浏览菜单：按 或 。
- 选择菜单选项：按 。
- 退出菜单：按 。





***MTM800***  
***TETRA Motorcycle Terminal***  
***Basic User Guide***



6815598H01-U



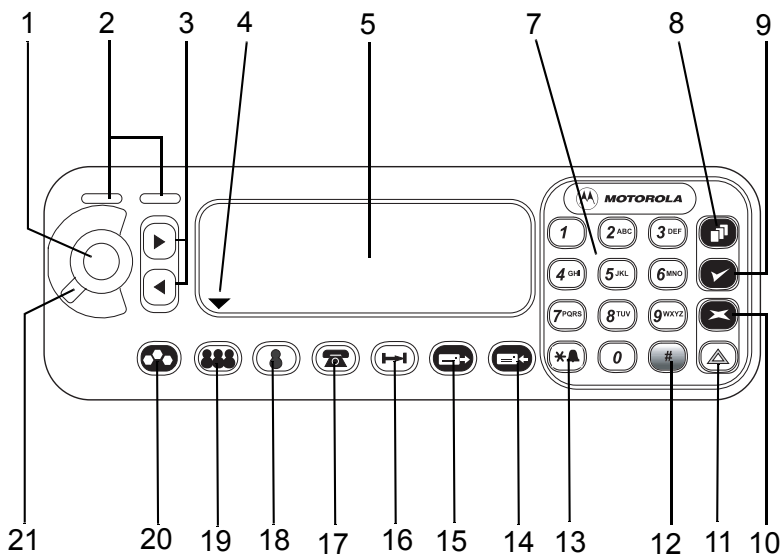

# Contents

---

<b>Safety Information</b> . . . . .	<b>3</b>
Disposal Information . . . . .	3
Copyright Information . . . . .	3
Icon Conventions . . . . .	4
<b>MTM800 Overview</b> . . . . .	<b>5</b>
Controls and Indicators . . . . .	5
Audio Signal Tones . . . . .	7
Periodic Alert . . . . .	9
Key and Button Overview . . . . .	10
Mode Keys . . . . .	10
Menu Key . . . . .	10
Emergency Button . . . . .	10
Function Keys . . . . .	10
The LED Status Indicator . . . . .	12
To Enter the Menu Options . . . . .	12
To Exit the Menu Options . . . . .	12
List of Menu Options . . . . .	13
The Display . . . . .	15
Display Icons . . . . .	15
Displaying Long Numbers or Messages . . . . .	16
<b>Getting Started</b> . . . . .	<b>17</b>
Powering the MTM800 On/Off (On/Off Button) . . . . .	17
Powering On the MTM800 (Ignition Sense) . . . . .	17
Powering On the MTM800 (Ext. Emergency Switch) . . . . .	17
Powering On with Transmit Inhibit Active . . . . .	17
Uninstalling the Radio . . . . .	18
Unlocking the MTM800 . . . . .	18
<b>Selecting TMO or DMO Operation</b> . . . . .	<b>19</b>
Entering TMO or DMO . . . . .	19
Calls (Trunked Mode Operation) . . . . .	19
TMO Group Calls . . . . .	19
Making a TMO Group Call . . . . .	19
Receiving a TMO Group Call . . . . .	20
Receiving a TMO Broadcast Call . . . . .	20

Calls (Direct Mode Operation) . . . . .	20
DMO Group Calls . . . . .	20
Making a DMO Group Call . . . . .	21
Receiving a DMO Group Call . . . . .	21
Exiting DMO . . . . .	21
<b>Calls (Private and Phone Calls) . . . . .</b>	<b>22</b>
Private Call . . . . .	22
Making a Private Call . . . . .	22
Receiving a Private Call . . . . .	22
Phone and PABX Calls . . . . .	23
Making a Phone or PABX Call . . . . .	23
VOX Control . . . . .	23
<b>Emergency Mode . . . . .</b>	<b>24</b>
Entering or Exiting Emergency Mode (TMO & DMO) . . . . .	24
Invisible Emergency Mode . . . . .	24
Sending an Emergency Alarm . . . . .	25
Hot Microphone Feature . . . . .	26
Making an Emergency Group Call . . . . .	26
<b>Messages . . . . .</b>	<b>27</b>
Sending a Status Message . . . . .	27
Sending a New Message . . . . .	27
Sending a User-defined Message . . . . .	27
Sending a Predefined Message . . . . .	27
Handling New Incoming Text Messages . . . . .	27
Handling Old Messages . . . . .	27
<b>Quick Reference Guide . . . . .</b>	<b>29</b>

MOTOROLA and the stylized M Logo are registered in the U.S. Patent and Trademark Office. All other product or service names are the property of their respective owners.

© 2006 – 2008 by Motorola, Inc.  
All rights reserved.

# Safety Information .

---



## CAUTION

*Before using these products, read the operating instructions for safe usage contained in the Product Safety and RF Exposure booklet 6804113J25 enclosed with your MTM800.*

The accessories are restricted to occupational use only to satisfy ICNIRP RF energy exposure requirements. Before using the products, read the RF energy awareness information and operating instructions in the Product Safety and RF Exposure booklet (Motorola Publication part number 6804113J25) to ensure compliance with RF energy exposure limits.

Keep this **User Guide** and the **Product Safety and RF Exposure booklet** in a safe place and make it available to other operators in case the accessories are passed on to other people.

## Disposal Information



The **European Union's Waste of Electrical and Electronic Equipment (WEEE)** directive requires that products sold into EU countries must have the crossed out trashbin label on the product (or the package in some cases). As defined by the

WEEE directive, this cross-out trashbin label means that customers and end-users in EU countries should not dispose of electronic and electrical equipment or accessories in household waste.

Customers or end-users in EU countries should contact their local equipment supplier representative or service centre for information about the waste collection system in their country.

## Copyright Information

The Motorola products described in this manual may include copyrighted Motorola computer programs stored in semiconductor memories or other mediums. Laws in the United States and other countries preserve for Motorola certain exclusive rights for copyrighted computer programs, but not limited to, including the exclusive right to copy or reproduce in any form the copyrighted computer program. Accordingly, any copyrighted Motorola computer programs contained in the Motorola products described in this manual may not be copied, reproduced, modified, reverse-engineered, or distributed in any manner without the express written

permission of Motorola. Furthermore, the purchase of Motorola products shall not be deemed to grant either directly or by implication, estoppel, or otherwise, any licence under the copyrights, patents, or patent applications of Motorola, except for the normal non-exclusive licence to use that arises by operation of the law in the sale of a product.

This document is copyright protected. Duplications for the purpose of the use of Motorola products are permitted to an appropriate extent. Duplications for other purposes, changes, additions or other processing of this document are not permitted. Only this electronically-saved document is considered to be the original. Duplications are considered merely copies. The group companies of Motorola, Inc. do not vouch for the correctness of such kinds of copies.

## Icon Conventions

The document set is designed to give the reader more visual cues. The following graphic icons are used throughout the documentation set. These icons and their associated meanings are described below.



**WARNING**

*The signal word Warning with the associated safety icon implies information that, if disregarded, could result in death or serious injury, or serious product damage.*



**CAUTION**

*The signal word Caution with the associated safety icon implies information that, if disregarded, may result in minor or moderate injury, or serious product damage.*

**CAUTION**

*The signal word Caution may be used without the safety icon to state potential damage or injury that is not related to the product.*

**NOTE**

*Notes contain information more important than the surrounding text, such as exceptions or preconditions. They also refer the reader elsewhere for additional information, remind the reader how to complete an action (when it's not part of the current procedure, for instance), or tell the reader where something is located on the screen. There is no warning level associated with a Note.*

# MTM800 Overview

---

## Controls and Indicators

The numbers below refer to the illustration on the inside front cover.

Number	Description
1	On-Off Key Used to turn the MTM800 On/Off (press and hold).
2	LED (Indicator)
3	Navigation Keys Press left or right for list scrolling while moving around the menu hierarchy or for alphanumeric text editing.
4	Display Arrows Indicate the present mode.
5	Alphanumeric Display Provides two lines of 14 characters with backlighting.
7	Alphanumeric Keypad Use the keypad to enter alphanumeric characters for dialing, address book entries and text messages.
8	Menu Key Used to enter the main menu and scroll the menu options.
9	Select Key
10	Cancel Key
11	Emergency Key Used to send Emergency Alarms (press and hold).
12	Backlight Key Dims and intensifies the terminal's backlight.
13	External Alarm Key Used to activate and deactivate the External Alarm (Horn & Lights).
14	Message Mail Key Selects the Message Mail mode of operation.
15	Status Mode Key Selects the Send Status mode of operation.

Number	Description
16	Direct Mode Key Enters/Exits Direct Mode Operation.
17	Phone Mode Key Selects the Phone/PABX Call modes of operation.
18	Private Mode Key Selects the Private Call mode of operation.
19	Group Call Key Selects the Group Call mode of operation.
20	Range Key Selects the talkgroup range or DMO gateway.
21	Volume Knob Adjusts the volume level.
	Push-To-Talk (PTT) Button Press and hold this button to talk, release it to listen.











**NOTE**







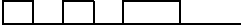







*Before using your MTM800 for the first time, remove the plastic lens protector from the display.*











## Audio Signal Tones

□ = High Tone; ■ = Low Tone;

Description	Type	Repeated
<b>Idle</b>		
<ul style="list-style-type: none"> <li>• Back to Home display</li> <li>• Back to rotary volume use when rotary scroll timer expires</li> <li>• Back to coverage</li> <li>• Back to full service</li> </ul>		Once
Clear-to-send		Once
Bad key press		Once
<ul style="list-style-type: none"> <li>• Good key press</li> <li>• MTM800 self-test fails at power up</li> <li>• From out-of-service to in-service</li> </ul>		Once
<b>In Call</b>		
Call clear warning		Once
Call waiting tone while Phone or Private Call are pending		Every 6 seconds, until a call is terminated.
Data Connected or Data Disconnected		Once
Talk Permit sounds upon pressing the PTT.		Once (Normal Tone)
		Once (Short Tone)
Talk Permit without gateway sounds upon pressing PTT. The tone indicates the gateway is no longer available.		Twice
		Once

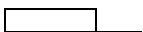
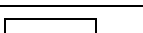
Description	Type	Repeated
<ul style="list-style-type: none"> <li>Talk Prohibit</li> <li>System busy</li> <li>Time-out timer expire</li> <li>Called terminal not available or busy</li> </ul>		Until you release the PTT.
<ul style="list-style-type: none"> <li>Call disconnected or failed due to network</li> <li>Wrong number dialled</li> </ul>		Once No tone
DMO (Direct Mode) Entering/Exiting		Once
DMO Exiting		Once
Local site trunking — Entering/Exiting		Once
Phone ring back (sending)		Every three seconds, until the called user answers or call is rejected.
Phone busy		Every 0.5 seconds
Status message sent to the dispatcher or failed.		Twice
<b>Incoming Calls</b>		
Status message acknowledged by the dispatcher.		Four times
Your MTM800 received a Group Call without gateway (setup only).		Once
High Priority Group Call received		Once
Emergency Alarm sent or received		Twice
Emergency Alarm failed		Four times
Emergency Call received		Once

Description	Type	Repeated
Phone ring, full-duplex Private Call (reception)	According to the Ring Style sub-menu setting.	Until you answer or the call is rejected.
Private Call received	According to the Ring Style sub-menu setting.	Until you answer or the call is rejected.
Private Call ringing to the caller		Until the call is answered.
Half-duplex Private Pre-emptive Priority Call (PPC) ring		Every 4 seconds, until the call is answered or rejected.
Full-duplex Private PPC ring		Every 4 seconds, until the call is answered or rejected.
Limited Service		Once upon entering limited service.
New Mail Received		Once
New Group Call		Once
<b>Battery/General</b>		
Volume setting (earpiece, keypad, speaker)		Continuous
Volume setting (ringer)		While setting the volume.
Transmit Inhibit (TXI)		Once

## Periodic Alert





This feature can be disabled/enabled by the user.

Press  - **4 Setup - 1 Tones - 5 Periodic Alert** also to set the period of time between the indications.

# Key and Button Overview

## Mode Keys

The MTM800 has four call modes when operating in Trunked Mode (TMO):

- Group mode – to send and receive Group Calls: Press 
- Private mode – to send and receive Private Calls: Press 
- Phone mode – to send and receive Phone Calls: Press  **1**
- PABX mode – to send and receive local (office) extension calls: Press  **2**.

Group mode is the default mode to which your MTM800 returns when there is no activity for a few seconds.

## Menu Key

Press  to enter the menu. The MTM800 menus allow you to control your MTM800 settings.

## Emergency Button

Press and hold  from any mode to enter the Emergency mode.

**NOTE** *The required time you need to press the Emergency button is set as default to 2 seconds. This time may be set, however, by your service provider.*

## Function Keys

### Numeric Keys

The MTM800 supports the one-touch feature that allows you to select or activate commonly used features by pressing and holding a numeric key.

### One Touch Private Call

The MTM800 supports the one-touch private call if it is set by the Service Provider. User can dial the last group call originator number via pressing the assigned button.

**NOTE** *The required time you need to press the Numeric keys to activate a one-touch function is set as default to 1 second. This time may be set, however, by your service provider.*

**NOTE**

For information on the function assigned to each Numeric key please refer to your service provider.

**List of Available Characters:**



Key	Alphanumeric Mode
1	.,?!01@'"/:_;+&%x*=<>€£\$¥¤□[] { } \ ^ ` ~ ¡ ¢ £ \$ %
2ABC	A B C 2 a b c 2
3DEF	D E F 3 d e f 3
4GHI	G H I 4 g h i 4
5JKL	J K L 5 j k l 5
6MNO	M N O 6 m n o 6
7PQRS	P Q R S 7 p q r s 7
8TUV	T U V 8 t u v 8
9WXYZ	W X Y Z 9 w x y z 9
*☎	Space * / %
0	0 + -
#	# = < >

## The LED Status Indicator

The LED indicator shows the states of your MTM800.

Indicator	Status
Solid GREEN	In use
Blinking GREEN	In service
Solid RED	Out of service
Solid RED	Connecting to a network / entering DMO
Solid ORANGE	Transmit Inhibit (TXI) in service / Channel busy in DMO
First solid then blinking ORANGE	Incoming call
No indication	Switched off

## To Enter the Menu Options

1. From any mode, press .
2. Scroll to the required option, press  to select.
3. Alternatively, key the numbers of the required option, typically **2 2 4** to reach **4 Mem Usage**.

## To Exit the Menu Options

Press .

### NOTE

*Your MTM800 may exit if no key presses are detected for a time-out period.*

# List of Menu Options

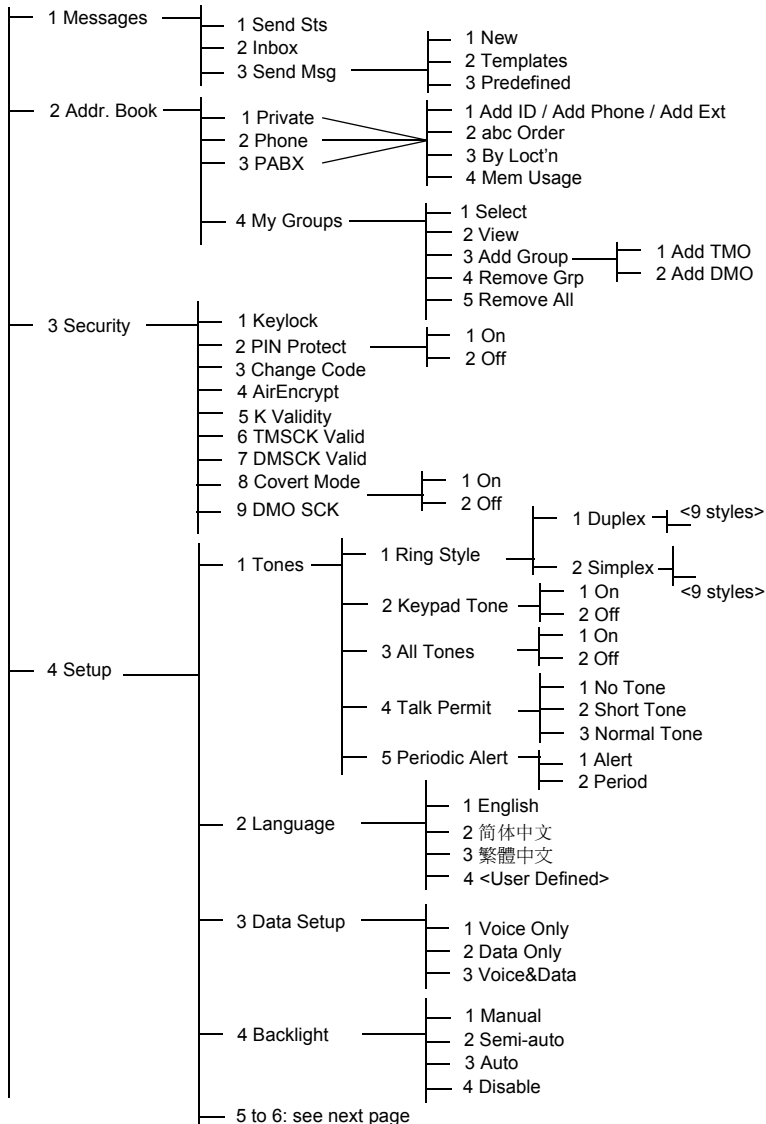

# List of Menu Options (Cont'd)

English

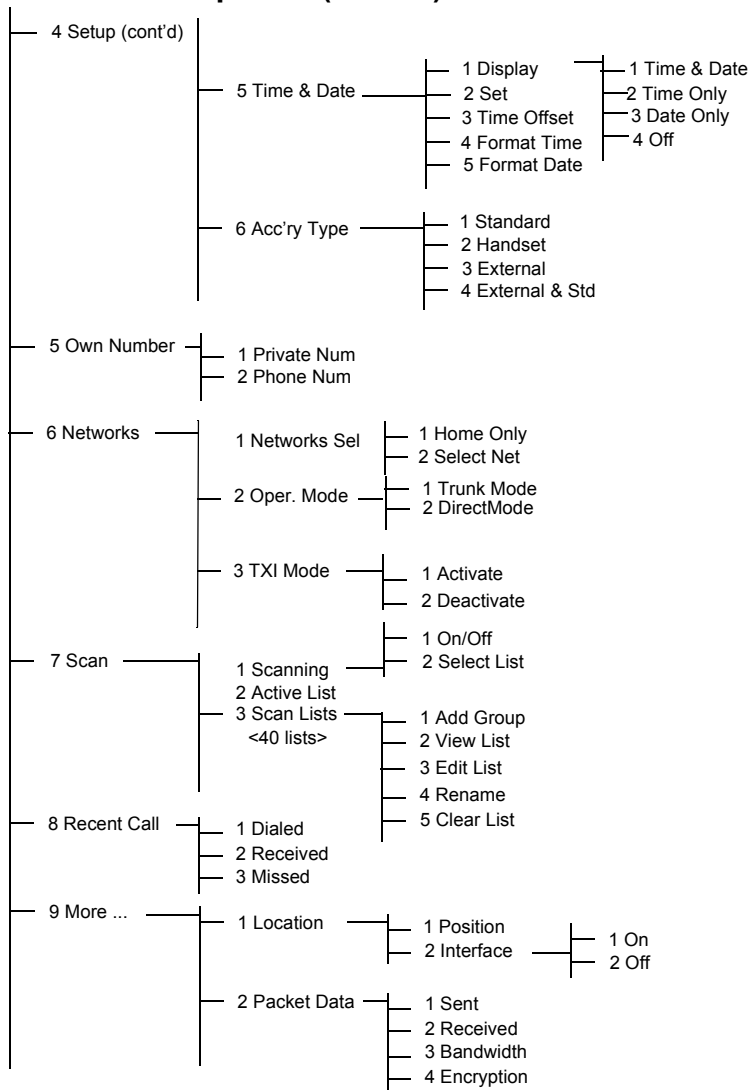









**NOTE**





Some menu numbers may be different than the listed as some menu options can be enabled/disabled by your Service Provider.

## The Display



### Display Icons

When you turn on your MTM800, icons appear along the top of the display to indicate the following conditions:

Display Icon	Description
<b>Trunked Mode Operation</b>	
	<b>Signal Strength (TMO)</b> Allows you to check signal strength. More bars indicate a stronger signal.
	<b>Priority Scan</b> Indicates priority scanning is activated in the MTM800.
	<b>Data Connected</b> Displayed when the MTM800 is successfully connected to an external device and ready for data transfer.
	<b>Data Transmit/Receive</b> Displayed when the MTM800 is transferring data to/ receiving data from the external device (laptop or desktop PC).
<b>Direct Mode Operation</b>	
	<b>Signal Strength (DMO)</b> Indicates an incoming Direct Mode Group Call.
	<b>Direct Mode</b> Displayed when the MTM800 is in Direct mode.

Display Icon	Description
	<p><b>DMO Gateway</b> Indicates that gateway is selected. The icon has three states:  <b>Solid</b> — while the MTM800 is synchronised with the gateway.  <b>Flashing</b> — while the MTM800 is not synchronised or during attachment.  <b>No icon</b> — during a terminal to terminal and repeater call.</p>
	<p><b>DMO Repeater</b> Displayed when the repeater option in DMO is selected. This icon has three states:  <b>Solid</b> — while the terminal has detected the repeater (i.e., when the terminal receives a presence signal).  <b>Blinking</b> — while the terminal has not detected the repeater or during attachment.  <b>No icon</b> — during a terminal to terminal and gateway call.</p>
<b>General Icons</b>	
	<p><b>Unread Message</b> Indicates that you have unread messages in your Inbox.</p>
	<p><b>New Message Has Arrived</b> Your Inbox could not open due to an on-going activity. The icon remains to remind you of new messages in your Inbox.</p>
	<p><b>Emergency</b> Appears while the MTM800 is in Emergency mode.</p>

## Displaying Long Numbers or Messages

Three dots after a number or message indicate that it continues on the next page. Press  to read the next “text” page and  to return to the previous page.

# Getting Started

---

## Powering the MTM800 On/Off (On/Off Button)

To power **On**, press and hold the On/Off push button. Your MTM800 performs a self-check and registration routine. After successful registration, the MTM800 is in service.

To power **Off**, press and hold the On/Off pushbutton. You will hear an audible beep and the **Powering Off** message is displayed.

## Powering On the MTM800 (Ignition Sense)

If the MTM800 is configured with ignition sense, the terminal will automatically turn on whenever the vehicle ignition is turned on.

## Powering On the MTM800 (Ext. Emergency Switch)

If an external Emergency Switch is connected and the MTM800 is powered off, press the Emergency Switch to power on. The MTM800 will power on in Emergency mode.

## Powering On with Transmit Inhibit Active

The TXI Mode remains active at power On.

You will be asked whether to leave the TXI Mode On or not.



### **WARNING**

*Ensure you have left the restricted area before deactivating Transmit Inhibit.*

Select **1 Exit TXI** to deactivate the TXI Mode. If the MTM800 was previously used in Trunked Mode (TMO), it will register to the network. If the MTM800 was previously used in Direct Mode it will remain in Direct Mode.

Select **2 Stay in TXI** in Trunked Mode and the MTM800 powers down; select **2 Stay in TXI** in DMO mode and you remain in DMO with TXI selected.

## Uninstalling the Radio



### CAUTION

#### OPTION 1:

Before disconnecting the 13.2V main power supply from the radio:

1. Switch off the radio.
2. Wait for a minimum of 4 seconds after the radio Off Switch is released.

Disconnect the 13.2V main power supply.

#### OPTION 2:

Turn off the main power supply **WITHOUT** switching OFF the radio.

## Unlocking the MTM800

Your MTM800 may be locked at power up.



To unlock the MTM800 after powering on, enter the code at the prompt. The MTM800 enters the default home mode.

# Selecting TMO or DMO Operation

---

## Entering TMO or DMO

Enter TMO or DMO in one of the following ways:

- Press and hold  (TMO) if the MTM800 is in DMO.
- Press and hold  (DMO) if the MTM800 is in TMO.







## Calls (Trunked Mode Operation)

### TMO Group Calls

A Group Call is a communication between you and others in a talkgroup. A Talkgroup is a pre-defined set of subscribers enabled to participate in and/or invoke a Group Call.

Talkgroups are divided into **ranges**. Each range may contain several talkgroups.

### Making a TMO Group Call

1. Press .
2. If this is the required talkgroup and range, press and hold the **PTT**. Wait for the talk permit tone and then speak into the microphone.  
Release the **PTT** button to listen.
3. If you wish to call a talkgroup other than the one shown, press  or  to scroll through the talkgroups.
4. To select a range other than the one shown, press , select the Range option, use  or  to scroll. Press  to confirm your selection (or **PTT** to start the call in the new range).

When you start a call, all members of the selected talkgroup who have their units turned on, will receive the transmission.

#### NOTE

*The “No Group” message is displayed when you are out of the normal coverage area of your selected talkgroup. You must then select a new talkgroup that is valid for your working location.*

## Receiving a TMO Group Call

Unless it is engaged in an active call, your MTM800 will automatically switch to Group Mode and receive the transmission. To answer the call, press and hold **PTT**.

Your MTM800 shows the Group name and the caller's private number or alias if previously stored in your address book.

**NOTE** *For incoming call alert, see settings in the Tones menu option.*

**NOTE** *When receiving a Group call, you will hear a "New Group Call" tone.*

## Receiving a TMO Broadcast Call

The Broadcast Call (also called Site Wide Call) is a high-priority group call from the console operator (or dispatcher) to all users. The MTM800s are configured to monitor a Broadcast Call, but users cannot talk back.

The Broadcast Call pre-empts an on-going Group Call that has the same (or lower) call priority.

## Calls (Direct Mode Operation)

### DMO Group Calls

In DMO, the MTM800 can be used without your Service Provider's infrastructure.

Direct Mode allows communication with other terminals also operating in Direct Mode, which are on the same frequency and talkgroup as your MTM800.

**NOTE** *In DMO it is only possible to place the following call types: Group Calls, Emergency Group Calls and Private Half-duplex Calls.*

You can receive a call from the selected talkgroup and from an open group. (An open group is a super-group of all DMO groups.)

When you start a call, the members of the selected talkgroup who have their units turned on will receive the transmission.

In DMO the MTM800 can communicate with the trunking system (and vice-versa) if the Gateway option is enabled in the MTM800.

## Making a DMO Group Call

1. Enter **Direct Mode** by selecting the Direct Mode option via the menu.
2. If this is the required talkgroup and range, press and hold the **PTT** button. Wait for the talk permit tone and then speak into the microphone.

Release the **PTT** button to listen.

## Receiving a DMO Group Call

You can receive a DMO Group Call only when your MTM800 is in DMO.

Your MTM800 will display the caller's private number or alias, and the talkgroup name.

## Exiting DMO

To exit DMO, select the Operating Mode option your MTM800 should be operating on.

# Calls (Private and Phone Calls)

---



## Private Call

A Private Call, also called Point-to-Point or individual call, is a call between two individuals. No other terminal can hear the conversation.

This call can be:

- a full-duplex call (if the system allows) in TMO
- a standard half-duplex call in TMO or DMO.

## Making a Private Call

1. To enter the Private Mode, press .
2. Enter the number of the person you wish to call.
3. Press and release the **PTT** button. You will hear a ringing tone. Wait for the called person to answer your call.
4. Press and hold **PTT**. Wait for the talk permit tone (if configured) before talking, and release the **PTT** when listening.
5. To end the call, press . If the called person ends the call, the **Call Ended** message is displayed.

### NOTE

*While Transmit Inhibit is activated, an incoming Private Call is indicated, but it is not possible to answer the call.*



## Receiving a Private Call

If the Service Provider configured the MTM800 to Automatic Mode Switch:

1. The MTM800 automatically switches to Private Mode. The display shows the caller's identity.
2. To answer the incoming call, press **PTT**.
3. To end the call, press . The display returns automatically to the mode it was in before the incoming call arrived.



If the Service Provider configured the MTM800 to Manual Mode Switch:

1. If the MTM800 is **NOT** in Private Mode, the Private Display Arrow starts blinking. The display returns to the mode it was in before the incoming call arrived.
2. To answer the call, press , and then the **PTT** button.
3. To end the call, press .

If the called person ends the call, the **Call Ended** message is displayed.

**NOTE** For call alert, see settings in the Tones menu option.

## Phone and PABX Calls

The **Phone Mode** allows you to call a landline telephone number or a cellular mobile phone number. In this publication we use “phone number” when referring to these numbers.

The **Private Automatic Branch Exchange (PABX) Mode** allows you to call local (office) extension numbers. This mode needs to be activated by your Service Provider.

Both modes have the same dialling features.

**NOTE** While Transmit Inhibit is activated, an incoming Phone or PABX Call is indicated, but it is not possible to answer the call.

## Making a Phone or PABX Call

1. Press , and select **1 Phone** or **2 PABX**.
2. Proceed as for making and receiving Private phone calls.

## VOX Control

VOX (Voice Operating Transmission) allows the user to transmit voice in a hands-free condition. The radio is detecting audio automatically when full duplex private call and telephone call use the fist microphone.

**NOTE** This feature is only available if set up by your Service Provider. If it is disabled, transmission can start upon pressing PTT.

# Emergency Mode

---

You can send and receive **Emergency Group Calls** in **Trunked Mode (TMO)** or in **Direct Mode (DMO)**. If your terminal is configured to operate through a gateway, Emergency calls can be placed through the gateway.

You can initiate an Emergency Group Call to and receive it from the selected talkgroup (TMO and DMO).

Your Service Provider will configure the Emergency Alarm and Hot Microphone features.

Emergency calls will be allocated emergency priority in the system.

## Entering or Exiting Emergency Mode (TMO & DMO)

To enter Emergency mode from any mode, press **and hold** the emergency button .

**NOTE** *For call alerts, see settings in the Tones menu option.*

**NOTE** *The required time you need to press the Emergency button is set to default to 2 seconds. The time can be configured by your Service Provider.*

To exit Emergency mode, press and hold . You will switch to normal Group mode.

## Invisible Emergency Mode

If the Invisible Emergency Mode is enabled by your Service Provider, all the audible and visible indications for operations in Emergency Mode are disabled.

**NOTE** *Only the Emergency Private Call is exception for this feature.*

## Sending an Emergency Alarm

Your MTM800 will automatically send an Emergency Alarm when in Emergency mode. This is sent:

- automatically, upon entering Emergency mode
- if you press  again while the MTM800 is in Emergency mode.

After sending the alarm, the screen will show one of the following delivery reports:

- **Alarm Sent**
- **Alarm Failed**

In both cases the screen returns within a few seconds to the main screen of the Emergency mode.

Due to no delivery confirmation in DMO, **Alarm Sent** information confirms only sending the alarm.

### NOTE

*The Emergency Alarm is a special status message sent to the dispatcher monitoring the selected talkgroup. This can be used in dispatch systems to highlight emergency calls.*

### NOTE

*Some systems do not support the Emergency Alarm feature when the user is in a "Local Area Service" area.*



### WARNING

*Pressing the Emergency button, even if Transmit Inhibit is activated, causes the MTM800 to radiate immediately. The MTM800 must NOT be within the RF sensitive area when entering Emergency mode.*

## Hot Microphone Feature

If the Hot Microphone feature was programmed into your MTM800 by your Service Provider, you can make an Emergency Group Call and talk to the dispatcher (and members of your talkgroup) without the need to press and hold the **PTT**.

The microphone will stay open for a time period (programmed by your Service Provider). The microphone will stay open until:

- the Hot microphone time period expires
- you press **PTT** during the Hot Microphone period
- you press the **End** key

At the end of the Hot Microphone the **Emgcy Mic Ended** message will be displayed and the MTM800 reverts back to the Emergency Mode. The Hot Microphone feature is disabled and PTT operation returns to normal.

If required you can resume Hot Microphone by pressing the emergency key again.

## Making an Emergency Group Call

- Hot Microphone enabled - to initiate an Emergency Group Call, press and hold **Emergency Button**.
- Hot Microphone disabled - to initiate an Emergency Group Call, press and hold **Emergency Button**. When the display has changed to Emergency Group Call hold **PTT** and wait for talk permit tone (if configured) and talk. Release the PTT to be able to listen.

# Messages

---

## Sending a Status Message

Select the desired group, then press  – **1 Messages** – **1 Send Sts** – **OK**. Select status and press **PTT** to send the status message.

## Sending a New Message

Press  – **1 Messages** – **3 Send Msg** – **1 New** – **OK**. Write your message. Press **Optns** and select **Send**. Select your mail recipient or enter number. Press **PTT** to send the new message.

## Sending a User-defined Message

Press  – **1 Messages** – **3 Send Msg** – **2 Templates** – **OK**. Scroll and choose your required template. Press **Optns** and select **Send**. Select your mail recipient or enter number. Press **PTT** to send the message.

## Sending a Predefined Message

Press  – **1 Messages** – **3 Send Msg** – **3 Predefined** – **OK**. Scroll and choose your required template. Press **Edit** to edit the message. Type required information. Press **PTT** to send the message.

## Handling New Incoming Text Messages

The  icon will flash on your display.

To enter the Inbox press  – **1 Messages** – **2 Inbox** – **OK**. Scroll to the messages and select **Read** soft key. To read a long message, press **More** to read the next page and **Exit** to return to the previous page.

## Handling Old Messages

Press  – **1 Messages** – **2 Inbox** – **OK**. Scroll to the messages and select **Optns**. You can read, erase one message or erase all by selecting the relevant option.

# Notes



# MOTOROLA MTM800

## Motorcycle Terminal

### Quick Reference Guide

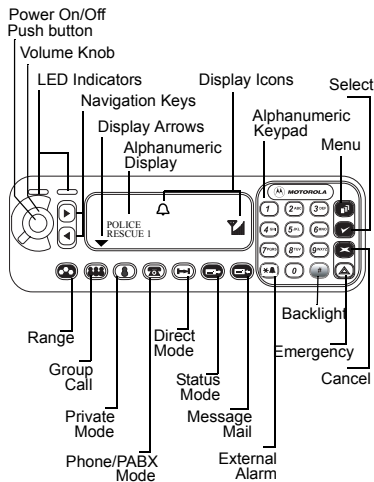

### Making a Phone/PABX Call

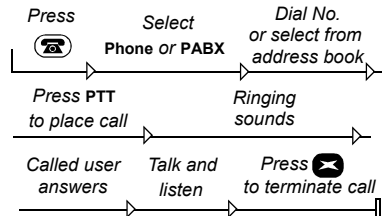

### Making a TMO Private Call

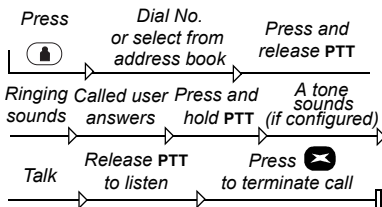

### Making a TMO Private Full-duplex Call

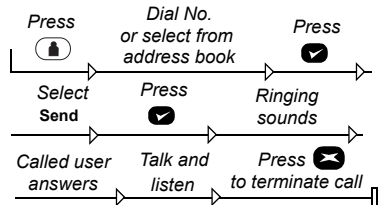

### Making a DMO Private Call

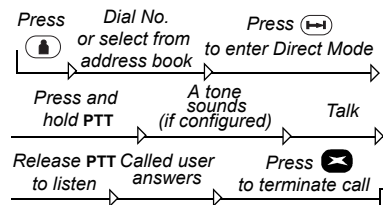

### Making a TMO or DMO Group Call

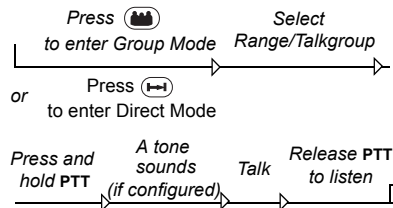

## Making an Emergency Group Call (in TMO Mode)

Press and hold . Emergency Alarm is sent automatically.

While in Emergency Mode, press and hold **PTT** to talk. If using Hot Mic feature, wait for the **Emergency Mic On** message to be displayed, and talk without pressing **PTT**.

To exit Emergency Mode press and hold .

## Answering a Call

Your MTM800 switches to the mode of the incoming call and starts ringing. To answer the call, press **PTT**.

## Sending a Status Message

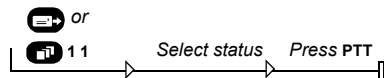

## Sending a New Message

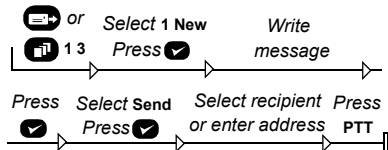

## Sending a User defined Message

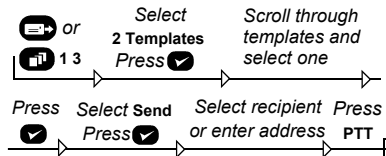

## Sending a Predefined Message

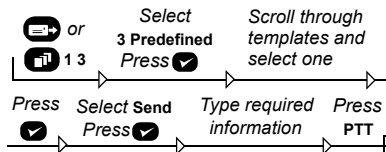

## Handling New Incoming Text Messages

The  icon will flash on your display and the MTM800 sounds a tone. For details see the Menu Messages section in the User Guide.

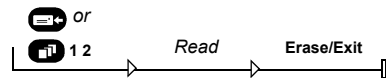



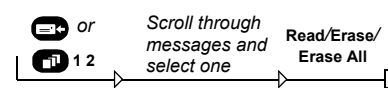

## Handling Old Messages



## Last Number Redial

Press **PTT** to call the last called number.

## Using the Menu

- Entering the menu: Press .
- Scrolling through the menu: Press  or .
- Selecting a menu option: Press .
- Exiting the menu: Press .