

Mobile Release 5.14.10



MTP830

FEATURE USER GUIDE



March 2014



© 2014 Motorola Solutions, Inc. All rights reserved.



68015000122-H

Contents

| | |
|--|-----------|
| List of Figures..... | 9 |
| List of Tables..... | 11 |
| | |
| Chapter 1: General Information..... | 13 |
| Safety Information..... | 13 |
| Copyrights..... | 13 |
| Icon Conventions..... | 14 |
| Using this Guide..... | 14 |
| Feature and Service Availability..... | 15 |
| | |
| Chapter 2: Getting Started..... | 17 |
| Product Technical Information..... | 17 |
| Before Power On..... | 17 |
| Attaching the Antenna..... | 17 |
| Installing the Battery..... | 18 |
| Removing the Battery..... | 18 |
| Charging the Battery..... | 19 |
| Charging Indicators..... | 20 |
| Low Battery Indication..... | 20 |
| Controls and Indicators..... | 21 |
| Display..... | 23 |
| Configurable Idle Screen..... | 24 |
| Status Icons..... | 25 |
| Powering On the Radio..... | 28 |
| Unlocking Your Radio..... | 28 |
| Unblocking Your Radio..... | 28 |
| Locking/Unlocking the Keys/Buttons..... | 29 |
| Holding Your Radio..... | 29 |
| Setting Flip Display..... | 30 |
| Entering TMO / DMO Mode..... | 30 |
| Transmit Inhibit Mode..... | 30 |
| Selecting Talkgroups..... | 31 |
| Talkgroup Icon Selection..... | 31 |
| Using Timed Talkgroup Change..... | 32 |
| Activating Talkgroup Scanning..... | 32 |
| Dialing through Soft Numeric Keypad..... | 32 |
| Broadcast Call..... | 33 |
| Ambience Listening (AL) Call..... | 33 |
| One-Touch Button Feature..... | 33 |
| Terminal Temporary Disable/Enable..... | 34 |
| Terminal Permanent Disable..... | 35 |
| High/Low Audio Toggle..... | 35 |
| Using High Audio..... | 35 |
| Using Low Audio..... | 35 |
| During the Call..... | 35 |
| Writing Text..... | 36 |
| Text Entry Icons..... | 36 |
| Keys Usage..... | 36 |
| Home Display Text Message..... | 37 |

| | |
|---|-----------|
| Chapter 3: Modes..... | 39 |
| Using Networks..... | 39 |
| Trunked Mode Operation..... | 39 |
| Entering TMO Mode..... | 40 |
| Selecting Talkgroups..... | 40 |
| Making Group Calls in TMO..... | 40 |
| Receiving Group Calls in Idle..... | 40 |
| Receiving Group Calls during Ongoing Group Calls..... | 40 |
| Dynamic Group Number Assignment (DGNA)..... | 41 |
| DGNA Reception..... | 41 |
| DGNA Auto Select Group..... | 41 |
| DGNA Auto Reselect Group..... | 41 |
| Viewing DGNA Talkgroups..... | 41 |
| Broadcast Calls Initiated by Users..... | 41 |
| Initializing Broadcast Calls..... | 42 |
| Phone and PABX Calls..... | 42 |
| Private Call..... | 42 |
| Making Private Calls..... | 42 |
| Assistance Call..... | 42 |
| Call Modification..... | 43 |
| Local Site Trunking..... | 43 |
| Entering Local Site Trunking..... | 43 |
| Exiting Local Site Trunking..... | 44 |
| Direct Mode Operation..... | 44 |
| Entering DMO Mode..... | 44 |
| Selecting Talkgroups..... | 44 |
| Making Group Calls in DMO..... | 45 |
| Receiving Group Calls in Idle..... | 45 |
| Private Call..... | 45 |
| Making Private Calls..... | 45 |
| Private Call With Presence Check..... | 46 |
| Talkgroup for Individual Calls..... | 46 |
| Communication through Repeaters..... | 46 |
| Communication through Gateways..... | 46 |
| Selecting DMO Group Call Options..... | 47 |
| Transmit Inhibit Mode..... | 47 |
| Emergency Operations..... | 48 |
| Emergency Group Call..... | 49 |
| Making Emergency Group Calls..... | 49 |
| Receiving Emergency Group Calls..... | 49 |
| Non-Tactical Emergency..... | 50 |
| Emergency Individual Calls (Private or MS-ISDN)..... | 50 |
| Emergency Alarm..... | 50 |
| Emergency SDS Status..... | 50 |
| Emergency Hot Microphone..... | 50 |
| Alternating Hot Microphone..... | 51 |
| Silent Emergency Mode..... | 51 |
| Invisible Emergency..... | 52 |
| Disaster Alert..... | 52 |
| Initializing Disaster Alert Calls..... | 52 |
| Exiting Emergency Operations..... | 52 |
| Chapter 4: GPS Location Service..... | 53 |

| | |
|---|-----------|
| Enhancing GPS Performance..... | 54 |
| Enabling GPS..... | 54 |
| GPS Icon..... | 54 |
| GPS Different Location Displays..... | 54 |
| Viewing Your Position..... | 55 |
| Changing GPS Accuracy..... | 55 |
| GPS – Things to Keep in Mind..... | 55 |
| Chapter 5: Main Menu..... | 57 |
| Scrolling through the Menu..... | 57 |
| Menu Icons..... | 57 |
| Messages..... | 58 |
| New Message..... | 58 |
| Sending Messages to Private/Phone..... | 59 |
| Sending Messages to Groups..... | 59 |
| Sending Store and Forward Messages..... | 59 |
| Delivery Report..... | 59 |
| Viewing Delivery Reports..... | 60 |
| Configuring Delivery Reports..... | 60 |
| Inbox..... | 60 |
| Entering the Inbox..... | 61 |
| Receiving New Messages..... | 61 |
| Using Submenus in the Inbox and the Outbox..... | 61 |
| Embedded Number..... | 62 |
| Storing Numbers from Messages..... | 62 |
| Calling Numbers in Messages..... | 62 |
| Making Group Calls on theTalkgroup of the Message Sender..... | 62 |
| Immediate Message..... | 63 |
| Outbox..... | 63 |
| CO Box..... | 63 |
| Templates..... | 63 |
| Sending User-Defined Templates..... | 63 |
| Setting User-Defined Templates..... | 64 |
| Predefined Templates..... | 64 |
| Viewing Predefined Templates..... | 64 |
| Sending Predefined Templates..... | 64 |
| Status Messages..... | 64 |
| Viewing a Status Message Number..... | 64 |
| Sending Status Messages..... | 65 |
| Targeted Status Messages..... | 65 |
| Sending Targeted Status Messages..... | 65 |
| Contacts..... | 65 |
| Creating Contacts..... | 66 |
| Editing Contacts..... | 66 |
| Deleting Numbers..... | 67 |
| Deleting Contacts..... | 67 |
| Checking Capacity..... | 67 |
| Dialing through the Contact List..... | 67 |
| Security..... | 67 |
| PIN Protect..... | 68 |
| Protecting the Radio with a PIN Code..... | 68 |
| Unblocking Your Radio..... | 68 |
| Changing PIN Codes..... | 68 |
| Keylock Setup..... | 68 |
| Keypad Lock Notification..... | 69 |

| | |
|---|----|
| Setting Automatic Keylock Delay..... | 69 |
| Setting Keylock on Startup..... | 69 |
| Air Encryption..... | 69 |
| Viewing the Air Encryption State..... | 70 |
| Air Encryption Key Deletion..... | 70 |
| K Validity..... | 70 |
| Verifying K Validity..... | 70 |
| SCK (Air Interface Encryption Class 2)..... | 70 |
| TMO SCK..... | 70 |
| DMO SCK..... | 70 |
| Changing DMO SCK..... | 71 |
| Verifying TMSCK Validity..... | 71 |
| Verifying DMSCK Validity..... | 71 |
| Covert Mode..... | 71 |
| Activating the Covert Mode..... | 72 |
| Setting to Vibrate in the Covert Mode..... | 72 |
| SDS Remote Control..... | 72 |
| Setting SDS Remote Control..... | 72 |
| Setup..... | 72 |
| Vibrate..... | 73 |
| Setting Default Vibrate..... | 73 |
| Setting Detail Vibrate..... | 73 |
| Ring Style..... | 73 |
| Setting Ring Style..... | 73 |
| Set Volume..... | 74 |
| Setting Volume..... | 74 |
| Language..... | 74 |
| Setting Language..... | 74 |
| Data Setup..... | 74 |
| Setting Data Function..... | 75 |
| Audio..... | 75 |
| Audio Profiles..... | 75 |
| Setting Audio Profiles..... | 75 |
| Howling Suppression..... | 75 |
| Setting Howling Suppression..... | 75 |
| Audio Toggle..... | 76 |
| Setting Audio Toggle..... | 76 |
| Volume Adjustment Mode..... | 76 |
| Setting Volume Adjustment Mode..... | 76 |
| Tones..... | 76 |
| Keypad Tone..... | 76 |
| Setting Keypad Tone..... | 76 |
| All Tones..... | 77 |
| Setting All Tones..... | 77 |
| Talk Permit..... | 77 |
| Setting Talk Permit..... | 77 |
| Clear to Send..... | 77 |
| Setting Clear to Send..... | 77 |
| Periodic Alert..... | 77 |
| Setting Periodic Alert..... | 77 |
| D-PTT Tones..... | 78 |
| Setting D-PTT Tones..... | 78 |
| Display..... | 78 |
| Setting Flip Display..... | 78 |
| Setting Font Level..... | 79 |
| Setting Large Idle Font..... | 79 |

| | |
|---|----|
| Setting Extra Zoom..... | 79 |
| Setting Extended Status Icons..... | 79 |
| Setting Screen Saver..... | 80 |
| Setting Backlight..... | 80 |
| Setting Wallpaper..... | 80 |
| Setting Contrast..... | 80 |
| Time and Date..... | 80 |
| Setting Time and Date on the Display..... | 81 |
| Setting the Time Format..... | 81 |
| Setting the Time Manually..... | 81 |
| Setting the Date Format..... | 81 |
| Setting the Date Manually..... | 82 |
| Setting Time Offset..... | 82 |
| Setting Automatic Updates for the Time and Date | 82 |
| Energy Economy..... | 82 |
| Enabling Energy Economy..... | 82 |
| Viewing the Energy Economy Status..... | 83 |
| Rotary Knob..... | 83 |
| Setting Rotary Knob Mode..... | 83 |
| Setting Rotary Lock..... | 83 |
| Setting In Keypad Lock..... | 83 |
| Setting Rotary Knob Wrap Around..... | 84 |
| Setting Rotary Knob Scroll Range..... | 84 |
| Setting Rotary Knob Talkgroup Selection..... | 84 |
| Setting Rotary Knob Function Keys..... | 84 |
| Group Setup..... | 85 |
| Scan..... | 85 |
| Activating Talkgroup Scanning..... | 85 |
| Setting Talkgroups in the Active Scan List..... | 85 |
| Setting Scan Lists..... | 86 |
| Deleting Talkgroups from Scan Lists..... | 86 |
| My Groups..... | 86 |
| Favorites..... | 86 |
| Favorite Folders..... | 86 |
| Favorite Talkgroups..... | 86 |
| Favorite Contact Numbers..... | 87 |
| Making Private Calls to Favorite Contact Numbers..... | 87 |
| Adding Folders to Favorites..... | 87 |
| Adding Contact Numbers to Favorites..... | 87 |
| Adding Talkgroups to Favorites..... | 88 |
| Deleting Folders from Favorites..... | 88 |
| Deleting Items from Favorites Folder..... | 88 |
| Deleting All Items from Favorite Folders..... | 88 |
| My Info..... | 89 |
| Viewing and Modifying Personal Information..... | 89 |
| Recent Calls..... | 89 |
| Viewing Recent Calls..... | 89 |
| Calling from Recent Calls..... | 90 |
| Storing Recent Calls to Contacts..... | 90 |
| Deleting Recent Calls..... | 90 |
| Networks..... | 90 |
| Selecting Network Operation Mode..... | 91 |
| Selecting Your Network..... | 91 |
| Using the Select Net Registration..... | 91 |
| Using the Foreign Network Registration..... | 91 |
| Using Any Network..... | 91 |

| | |
|---|------------|
| Using the Migrate To Registration..... | 92 |
| Location..... | 92 |
| Viewing Your Position..... | 92 |
| Changing GPS Accuracy..... | 92 |
| Packet Data..... | 92 |
| Viewing Data Statistics..... | 93 |
| Viewing Encryption Status..... | 93 |
| Chapter 6: Features..... | 95 |
| Private Call..... | 95 |
| Making Private Calls..... | 95 |
| Dialing through Soft Numeric Keypad..... | 95 |
| Phone and PABX Calls..... | 96 |
| Making Phone or PABX Calls..... | 96 |
| Phone/PABX Speed Dial..... | 96 |
| Using the Phone/PABX Speed Dial..... | 96 |
| DTMF Overdial..... | 96 |
| Short Number Dial..... | 96 |
| Call-Out..... | 97 |
| Types of Call-Out Alerts..... | 97 |
| Call-Out Modes Interaction..... | 97 |
| Call-Out Service Phases..... | 98 |
| Shadow Groups (Address Bundle)..... | 98 |
| Appendix A: Tones..... | 99 |
| Appendix B: LED Indications..... | 101 |
| Appendix C: Troubleshooting..... | 103 |
| Appendix D: Maintenance..... | 107 |
| Storage..... | 107 |
| Extending Battery Life..... | 107 |
| Battery Charging Temperature..... | 107 |
| Battery Charging Rules..... | 108 |
| Additional Battery Warnings/Cautions..... | 108 |
| Looking after Your Radio..... | 108 |

List of Figures

| | |
|--|----|
| Figure 1: Trunked Mode Operation | 39 |
| Figure 2: Direct Mode Operation | 44 |
| Figure 3: Call-Out Message | 97 |

List of Tables

| | |
|--|-----|
| Table 1: Special Notations | 15 |
| Table 2: Product Technical Information | 17 |
| Table 3: Battery Icons | 20 |
| Table 4: Controls and Indicators | 21 |
| Table 5: Display | 24 |
| Table 6: Colors of the Soft Key Area | 24 |
| Table 7: Status Icons | 25 |
| Table 8: Talkgroup Icon | 31 |
| Table 9: One-Touch Button Features | 33 |
| Table 10: During the Call | 35 |
| Table 11: Text Entry Screen Icons | 36 |
| Table 12: Keys Usage | 36 |
| Table 13: Different Location Displays | 54 |
| Table 14: Menu Icons | 57 |
| Table 15: Inbox Icons | 60 |
| Table 16: Outbox Icons | 63 |
| Table 17: Contact Types | 65 |
| Table 18: Radio Tones | 99 |
| Table 19: LED Indications | 101 |
| Table 20: Displayed Messages | 103 |

Chapter 1

General Information

Safety Information

RF Energy Exposure and Product Safety Guide For Two-Way Radios

ATTENTION!

Before using this product, read the RF Energy Exposure and Safety Guide that ships with the radio which contains important operating instructions for safe usage and RF energy awareness and control for Compliance with applicable standards and regulations.

Copyrights

The Motorola products described in this document may include copyrighted Motorola computer programs. Laws in the United States and other countries preserve for Motorola certain exclusive rights for copyrighted computer programs. Accordingly, any copyrighted Motorola computer programs contained in the Motorola products described in this document may not be copied or reproduced in any manner without the express written permission of Motorola.

© 2014 Motorola Solutions, Inc. All Rights Reserved.

No part of this document may be reproduced, transmitted, stored in a retrieval system, or translated into any language or computer language, in any form or by any means, without the prior written permission of Motorola Solutions, Inc.

Furthermore, the purchase of Motorola products shall not be deemed to grant either directly or by implication, estoppel or otherwise, any license under the copyrights, patents or patent applications of Motorola, except for the normal nonexclusive, royalty-free license to use that arises by operation of law in the sale of a product.

Disclaimer

Please note that certain features, facilities, and capabilities described in this document may not be applicable to or licensed for use on a particular system, or may be dependent upon the characteristics of a particular mobile subscriber unit or configuration of certain parameters. Please refer to your Motorola contact for further information.

Trademarks

MOTOROLA, MOTO, MOTOROLA SOLUTIONS, and the Stylized M Logo are trademarks or registered trademarks of Motorola Trademark Holdings, LLC and are used under license. All other trademarks are the property of their respective owners.

European Union (EU) Waste of Electrical and Electronic Equipment (WEEE) directive



The European Union's WEEE directive requires that products sold into EU countries must have the crossed out trashbin label on the product (or the package in some cases).

As defined by the WEEE directive, this cross-out trashbin label means that customers and end-users in EU countries should not dispose of electronic and electrical equipment or accessories in household waste.

Customers or end-users in EU countries should contact their local equipment supplier representative or service centre for information about the waste collection system in their country.

Open Source Software (OSS) Legal Notices

For details on OSS Legal Notices visit Motorola Online (emeaonline.motorolasolutions.com) or browse the CPS Plus disc.

Icon Conventions

The following graphic icons, which help identify situations or settings crucial to proper radio operation and user safety, are used throughout this document:



Danger: The signal word DANGER with the associated safety icon indicates information that, if disregarded, will result in death or serious injury.



Warning: The signal word WARNING with the associated safety icon indicates information that, if disregarded, could result in death or serious injury, or serious product damage.



Caution: The signal word CAUTION with the associated safety icon indicates information that, if disregarded, may result in minor or moderate injury, or serious product damage.

Caution: The signal word CAUTION may be used without the safety icon to state potential damage or injury that is not related to the product.



Important: IMPORTANT statements contain information that is crucial to the discussion at hand, but is not CAUTION or WARNING. There is no warning level associated with the IMPORTANT statement.



Note: NOTE contains information more important than the surrounding text, such as exceptions or preconditions. They also refer the reader elsewhere for additional information, remind the reader how to complete an action (when it is not part of the current procedure, for instance), or tell the reader where something is located on the screen. There is no warning level associated with a note.



Suggestion: SUGGESTION indicates a recommendation from Motorola that does not require to be followed, but might be helpful. There is no warning level associated with SUGGESTION.

Using this Guide

The following special notations are used throughout the text to highlight certain information or items:

Table 1: Special Notations

| Example | Description |
|----------------------------------|---|
| MENU key or EMERGENCY button | Capital letters indicate a name of a key or button. |
| <i>Entering TMO tone</i> | Italic words indicate a name of the tone. |
| Powering Off | Bold words indicate the soft menu items, MMI strings, or messages displayed on the radio. |
| Setup → Tones → All Tones | Bold words with the arrow between indicate navigation structure in the menu items. |

Feature and Service Availability

This guide describes all available radio features and services. Your service provider may have customized your radio to optimize its use for your individual needs. Check with you service provider to find out the differences from this guide.

Chapter 2

Getting Started

This chapter contains basic information on how to use the radio.

Product Technical Information

Table 2: Product Technical Information

| Description | Value | | |
|-----------------------------|--------------------------------------|----------|----------|
| Maximum Voltage | 4.2 V | | |
| Maximum Current | 0.5 A | | |
| Maximum RF Power | 1 or 1.8 W (switchable) | | |
| Maximum Speaker Load | 0.5 W at 8 Ω | | |
| Antenna Impedance | 50 Ω | | |
| Operating Temperature Range | -25 $^{\circ}$ C to +60 $^{\circ}$ C | | |
| Operating Time | Duty Cycle | 950 mAh | 1850 mAh |
| | 05/05/90 | > 12.5 h | > 23 h |
| | 05/35/60 | > 9 h | > 17 h |
| | Talk Time | 1.9 h | 3.5 h |



Note: The communication system determines the radio transmit and receive time (operating cycle time). During overload, or beyond the systems specifications at high ambient temperatures, the thermal control cuts down the RF power output, which reduces the radio coverage range.

Before Power On

Read this section before you power on your radio for the first time.

Attaching the Antenna

Procedure:

- 1 Insert the screw-in base of the antenna into the antenna terminal on the top of the radio.
- 2 Turn clockwise until snug.

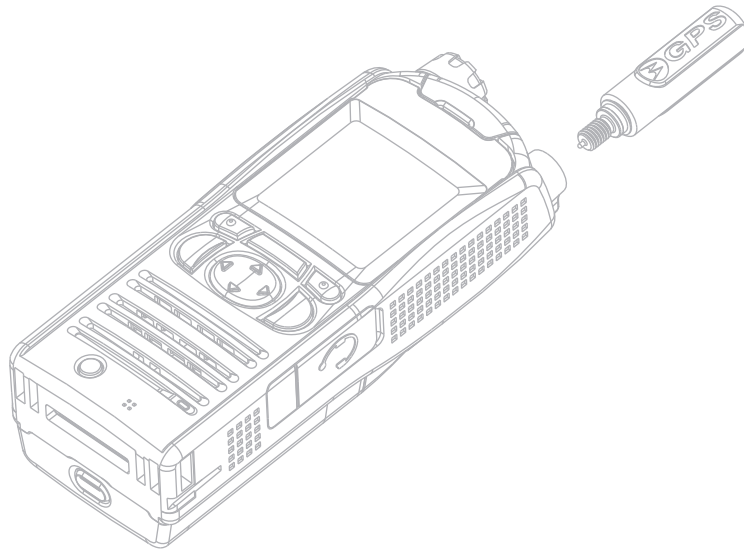

Installing the Battery

Procedure:

- 1 Remove the battery from its protective case.
- 2 Insert the battery top into the compartment as illustrated.

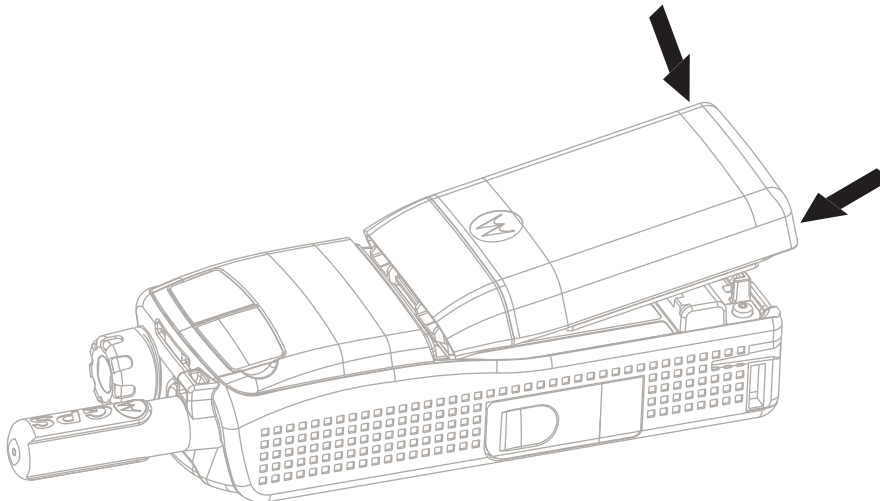

- 3 Carefully press the battery bottom downward until it clicks into place.



Note:

- Your service provider can configure the radio to turn on automatically after you insert the battery.
- Your radio always powers up, if you remove the battery for a period shorter than 3-5 seconds.

Related Links

[Removing the Battery](#) on page 18

Removing the Battery

Prerequisites: Turn off the radio.

Procedure:

- 1 Push the latch.
- 2 Lift the battery out.

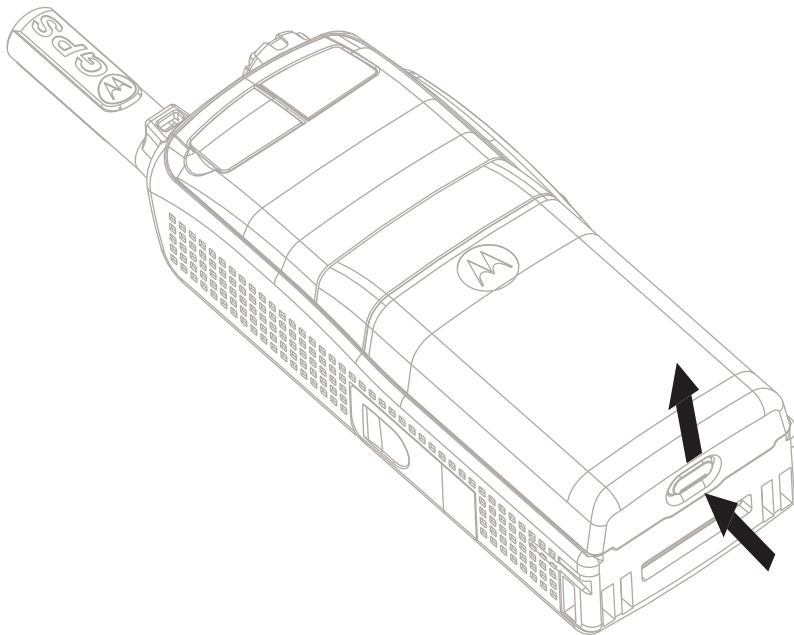
**Related Links**

[Installing the Battery](#) on page 18

Charging the Battery

Depending on a charger type, you can charge a battery alone or/and a battery attached to a radio.

Charging a battery attached to a radio can be done with the radio either turned on or off. Charging with the radio turned off is recommended since this is more efficient (the battery charges faster).



Important: Motorola approved chargers provide optimum performance. Other chargers may not fully charge your Motorola Lithium-Ion battery or may reduce the life of the battery.

Prerequisites:

Do not charge the battery in a hazardous area.

Procedure:

- 1 Connect the charger to an appropriate power source (100–240 V, 12 V), according to the specification of the charger.
- 2 Perform one of the following actions:
 - Desktop chargers – insert the battery or the radio with the battery attached into the appropriate socket of the charger. Ensure that the battery/radio made good connection with the charger and that the LED on the charger is indicating that charging is in progress
 - Travel chargers and car chargers – connect the charger to the radio with the battery attached. Ensure that the charger is firmly connected to the radio and that the radio display is indicating that charging is in progress.









Post requisites: The battery may heat up during charging. After charging, make sure that the battery and the radio are within the operating temperature range before using the radio.

Charging Indicators

When your radio is turned on while charging, it displays an icon of the battery in charging.

When your radio is turned off while charging, it displays the icon of the battery in charging and backlights the display.

Table 3: Battery Icons

| Battery Capacity | | | | Battery Charge Progress | | | |
|---|---|---|---|---|---|---|---|
|  |  |  |  |  |  |  |  |
| Empty | Low | Middle | Full | Empty | Low | Middle | Full |
| 5%–10% | 10%–20% | 20%–90% | 90%–100% | 5%–10% | 10%–20% | 20%–90% | 90%–100% |

Low Battery Indication

The radio indicates low battery level by playing an audible alert when the battery charge falls to a preset level. The low battery alert can be programmed by your service provider to 5, 10, or 20 per cent of remaining capacity. The default setting is 5 per cent. The service provider also configures how frequently the alert repeats.

Controls and Indicators

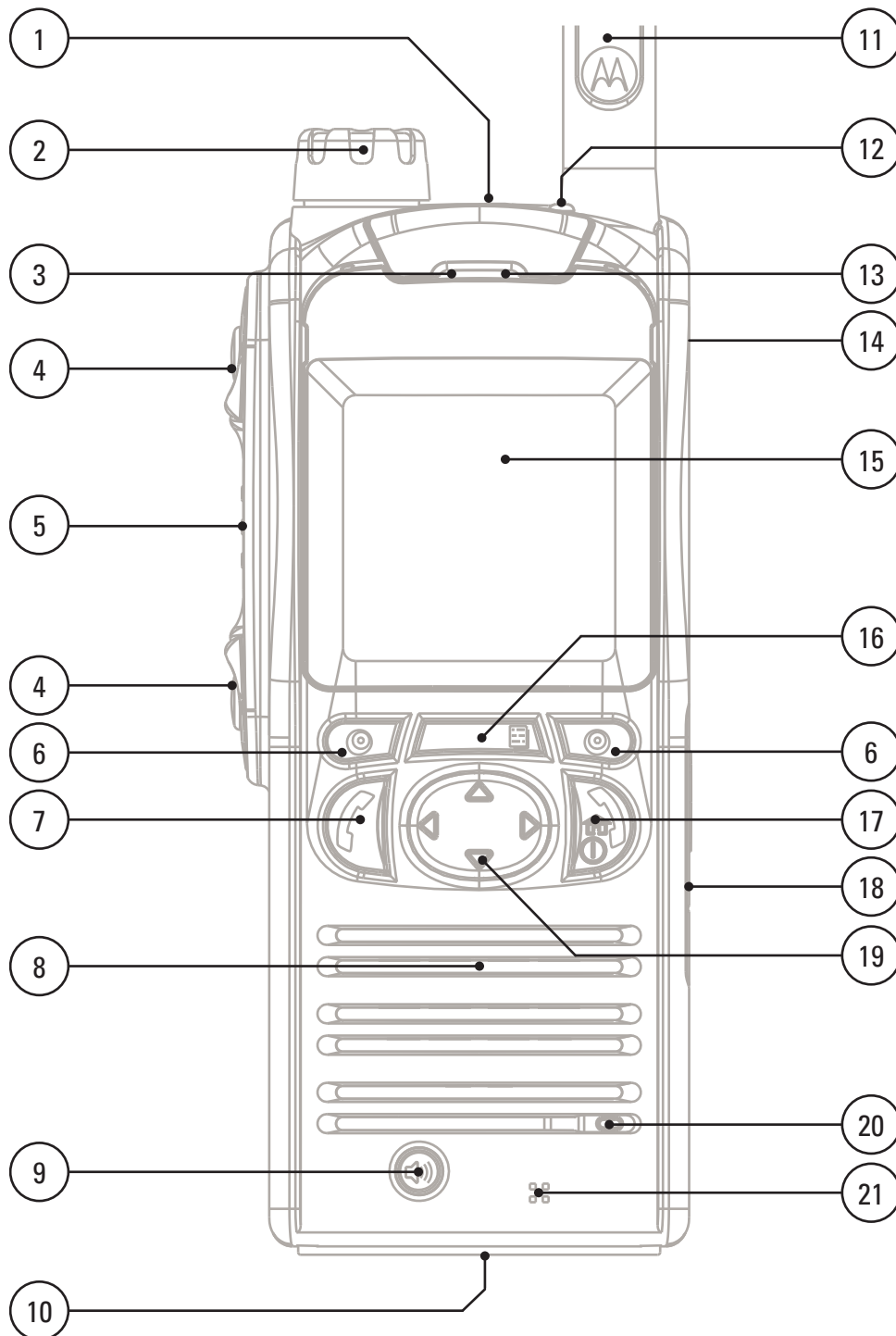

Table 4: Controls and Indicators

| Annotation | Description |
|------------|------------------|
| 1 | EMERGENCY button |

Table continued...





| Annotation | Description |
|------------|--|
| | Press and hold EMERGENCY button to enter Emergency operation. When your radio is off, press and hold to power on in Emergency Mode. |
| 2 | ROTARY KNOB <ul style="list-style-type: none"> • Rotate to set the volume. • Press and rotate to select a different talkgroup. • Press and hold the ROTARY KNOB to lock/unlock it. Powering off also unlocks a locked ROTARY KNOB. |
| 3 | EARPIECE |
| 4 | SIDE button <p>The ROTARY KNOB and SIDE buttons programming are paired. When the ROTARY KNOB is set to Volume or Dual, the SIDE buttons support the One-Touch Button feature. By default, the upper SIDE button is set to Backlight feature and the lower SIDE button is set to Screen Saver feature.</p>  <p>Note: The required time to press and hold SIDE button to activate an One-Touch Button feature is set as default to 0,1 second.</p> |
| 5 | PTT button (Push-To-Talk) <ul style="list-style-type: none"> • Press and hold to talk in simplex calls or to initiate a group call, release it to listen. • Press to send status and text messages. |
| 6 | SOFT key <p>Press left or right SOFT key, to select the option that appears on the screen directly above the them.</p> |
| 7 | SEND key <p>Press to initiate or answer duplex calls, or send messages.</p> |
| 8 | SPEAKER |
| 9 | SPEAKER CONTROL key <p>Press the SPEAKER CONTROL key to activate the earpiece Speaker LOW or speaker Speaker HIGH.</p>  <p>Note: In an Emergency Group Call, the speaker is activated regardless of the speaker setting.</p> |
| 10 | ACCESSORY CONNECTOR <p>Provides connection for accessories and cable for data transfer.</p>  <p>Note: It is recommended to turn off the radio before connecting accessories.</p> |
| 11 | ANTENNA |
| 12 | LED |
| 13 | TOP MICROPHONE |

Table continued...

| Annotation | Description |
|------------|--|
| | Activated during Simplex, high audio calls such as Group Calls. |
| 14 | EXTERNAL ANTENNA CONNECTOR Used with the digital car kit to connect the RF signal to the external antenna. |
| 15 | DISPLAY Provides alphanumeric text and images within 65,536 colors and 130 x 130 pixels with backlight, scalable fonts, and contrast. |
| 16 | MENU key <ul style="list-style-type: none"> From the home screen, press to enter the main menu. Used to enter the context-sensitive menu. |
| 17 | ON/OFF/END/HOME key <ul style="list-style-type: none"> Press and hold to turn on/off your radio. Press to end calls. Press to return to the home screen. |
| 18 | AUDIO ACCESSORY CONNECTOR Provides connection for audio accessories.  Note: It is recommended to turn off the radio before connecting accessories. |
| 19 | NAVIGATION key Press up, down, left or right NAVIGATION key for list scrolling, while moving around the menu hierarchy, or for alphanumeric text editing. From the home screen, press to activate one of the following: <ul style="list-style-type: none"> down NAVIGATION key — enters Recent Calls menu item. up NAVIGATION key — changes My Groups talkgroup folder. left and right NAVIGATION key — toggles through the talkgroups. |
| 20 | BACKLIGHT SENSOR Your radio keypad can be illuminated whenever the backlight is on. The keypad backlight sensor determines whether there is a need to light up the keypad backlight, by measuring the ambient light intensity. This feature can improve power saving. When the radio is in the battery charger, the keypad backlight remains illuminated and the BACKLIGHT SENSOR is ignored. |
| 21 | BOTTOM MICROPHONE |
| |  Note: A detailed list of compatible accessories is included in <i>Accessory Leaflet</i> , part number: 68015000558. To obtain the document, contact your service provider. |

Display

This section presents the radio's default home screen elements.

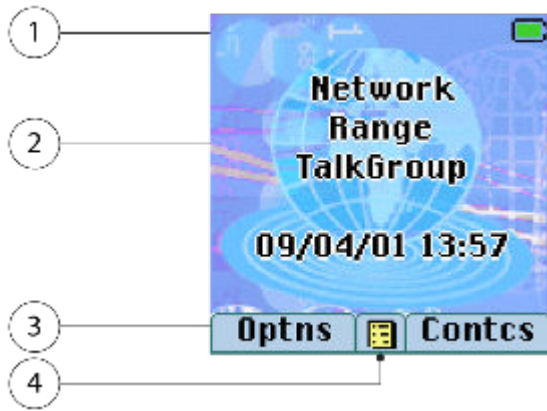
**Table 5: Display**

| Annotation | Description |
|------------|-----------------------------|
| 1 | Status icon area |
| 2 | Text display area |
| 3 | SOFT key area |
| 4 | MENU/Context sensitive icon |

The color of the SOFT key area changes according to the mode the radio is in.

Table 6: Colors of the SOFT Key Area

| Color | Mode or State |
|------------|---------------------------------------|
| Light blue | Normal TMO and DMO Modes |
| Light red | Emergency Mode or Disaster Alert Call |
| Olive | Local Site Trunking Mode |
| Yellow | Call Out — Standby |
| Red | Call Out — Alert |
| Green | Call Out — Accepted |

Related Links

[Display](#) on page 78

[Display](#) on page 78

[Setting Time and Date on the Display](#) on page 81

Configurable Idle Screen

Your service provider can configure the information that is displayed on the home screen below the status icon area. Depending on the radio configuration and services supported, the following information can be displayed:

- Network alias
- Range alias
- Talkgroup alias
- Time and date
- Home mode display
- RMS/FMS

- ISSI
- Radio status
- Audio profile name

Status Icons

Status icons appear when your radio is engaged in certain activities or when you have activated certain features.

The icons can appear in normal or large size. To manually enable/disable large status icons, go to **Menu** → **Setup** → **Display** → **Extended Status Icons**.

Table 7: Status Icons















| Icon | Description |
|--|---|
| Trunked Mode Operation | |
|  | In Service |
|  | No Service |
|  | Signal Strength – The more bars, the stronger the signal. |
|  | Migration — Displayed when your radio is registered to the foreign network. |
|  | Broadcast Call — Displayed when the radio is in the Broadcast Call. |
|  | Scan — Indicates talkgroup scanning is activated in the radio. |
|  | Priority Scan — Indicates that priority scanning is activated in the radio. |
|  | Data Connected — Displayed when the data connection is idle (standby). |
|  | Data Transmit/Receive — Displayed when the data connection is active. Number 1, 2, 3, or 4 indicates how much bandwidth is used during transmission (25%, 50%, 75%, or 100%). |
| Direct Mode Operation | |
|  | Direct Mode Call — Displayed when the radio is receiving a Direct Mode call. The more bars, the stronger the signal. |
|  or  | High RF Power: idle or transmitting — Displayed when the High RF Power option is enabled and the radio is either in the idle mode or transmitting a call. |
|  | High RF Power: receiving — Displayed when the High RF Power option is enabled and the radio is receiving a call. |
|  | Direct Mode — Displayed when the radio is in Direct Mode (radio-to-radio communication). |
|  | DMO Gateway Communication Mode — Indicates that gateway is selected. The icon has the following states: |

Table continued...













| Icon | Description |
|---|--|
| <ul style="list-style-type: none"> • Solid — while the radio is synchronized with the gateway. • Blinking — while the radio is not synchronized or during attachment. • No icon — during a radio to radio and repeater call. | |
|  | <p>DMO Repeater Communication Mode — Displayed when the Repeater or GW + Rep option in DMO Mode is selected. This icon has the following states:</p> <ul style="list-style-type: none"> • Solid — while the radio has detected the repeater (for example when the radio receives a presence signal). • Blinking — while the radio has not detected the repeater or during attachment. • No icon — during a radio to radio and gateway call. |
| General Icons | |
|  | <p>All Tones Off and Duplex and Simplex Ring Muted — Indicates that all alert tones are off and both duplex and simplex ring volume is set to 0.</p> <ul style="list-style-type: none"> • Volume is set to 0 (when Volume Adj. Mode is set to Common). • Both simplex and duplex ring volume is set to 0 (when Volume Adj. Mode is set to Individual). |
|  | <p>Simplex Ring Muted — Indicates that simplex ring volume is set to 0 and duplex ring volume is set to more than 0.</p> |
|  | <p>Duplex Ring Muted — Indicates that duplex ring volume is set to 0 and simplex ring volume is set to more than 0.</p> |
|  | <p>Vibrate On — Indicates that the radio vibrates to alert you of an incoming call.</p> |
|  | <p>Vibrate then Ring — Indicates that the radio vibrates and rings to alert you of an incoming call.</p> |
|  | <p>Low Audio — Indicates that the audio mode is changed to low.</p> |
|  | <p>High Audio — Indicates that the audio mode is changed to high.</p> |
|  | <p>Audio Profile Selected — Indicates that an audio profile associated with a particular icon is active. The icons can be either solid or blinking. For details on audio profiles available on the radio, contact your service provider.</p> |
|  | <p>Earpiece Connected — Indicates that the earpiece is connected.</p> |
|  | <p>GPS Icon</p> <ul style="list-style-type: none"> • Solid - the radio has a location fix • Blinking - the radio is acquiring a location fix. This is an optional setting and may not be enabled on your radio. |
|  | <p>Battery Strength — Shows the charge of your battery.</p> |
|  | <p>Battery Charging — Indicates that the battery is charging.</p> |

Table continued...



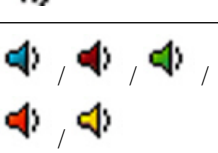











| Icon | Description |
|---|---|
|  | Emergency — Appears while the radio is in Emergency Operation. |
|  | Disaster Alert Call — Appears while the radio is in the Disaster Alert Call. |
|  | List Scrolling — Displayed to indicate that the ROTARY KNOB is in list scrolling mode. |
|  | New Message Has Arrived — Indicates a new message just arrived. |
|  | New Message(s) in Inbox — Indicates that you have unread messages in your Inbox . |
|  | Call-Out — Indicates Call-Out alert. |
|  | Call-Out Alert Arrived — Indicates a receipt of a new Call-Out message. |
|  | Call-Out Alert Unread — Indicates unread alert in the CO Box . |
|  | <p>End-to-End Encryption (E2EE)</p> <p>Solid, when the E2EE is enabled</p> <ul style="list-style-type: none"> • for the selected talkgroup, • for the highlighted private number, • for the manually entered private number, • when transmitting voice in Group Calls, • when transmitting voice in Simplex Private Calls. <p>Blinking, when the End-to-End Encryption is enabled</p> <ul style="list-style-type: none"> • when receiving voice in Group Calls, • when receiving voice in Simplex Private Calls, • during encrypted Duplex Private Calls. |
|  | <p>SDS End-to-End Encryption</p> <p>Solid, when the E2E status of an SDS message, or the E2E status of a message recipient address.</p> <p>In High Security mode, when your radio processes only the encrypted information, this icon is always visible in when you are in the messages menu (for example, Inbox).</p> |
|  | Keys Locked — Indicates that keys are locked. |
|  | <p>Non Secured Call — Air Encryption Unavailable</p> <p>Blinking, indicates that Air Encryption is not available when the radio:</p> <ul style="list-style-type: none"> • Is in the Local Site Trunking Mode. • Attempts to connect to a gateway. |
|  | <p>Not Secured Call — Air Encryption Unavailable</p> <p>Alternately blinking, indicates that Air Encryption is not available when the radio:</p> <ul style="list-style-type: none"> • Is in TMO Mode. |

Table continued...

| Icon | Description |
|---|--|
| | <ul style="list-style-type: none"> Communicates through a gateway. |
|  | <p>Not Secured Call — Air Encryption Unavailable</p> <p>Blinking, indicates that Air Encryption is not available in DMO Mode. The icon appears after the PTT button is pressed.</p> |
|  | <p>Remote Control</p> <p>Indicates that the radio is being remotely controlled and some commands are being executed in the background. For example, when the radio is controlled via special SDS messages or triggered to send a GPS location report.</p> <p>The icon is not visible in the Extra Zoom Mode.</p> |

Related Links

[Air Encryption](#) on page 69

Powering On the Radio

Procedure:

- 1 Press and hold ON button.
- 2 Your radio performs a self-check and registration routine.
- 3 After successful registration, your radio is in service.



Note: Your radio powers on without visible and audible notification if Covert Mode is activated.

Unlocking Your Radio

Your radio may be locked at power up. To unlock it after powering on, enter the code at the prompt. Your radio enters the default home display.



Note: The unlock code is originally set to 0000. Your service provider may change this number before you receive your radio.

Related Links

[PIN Protect](#) on page 68

[Changing PIN Codes](#) on page 68

[Writing Text](#) on page 36

Unlocking Your Radio

Prerequisites: You blocked your radio by entering incorrect PIN code for three times (by default).

Procedure:

- 1 Radio displays **Unit Blocked** Enter PUK.
- 2 Enter 8–digit PUK (Personal Unblocking Key) number.



Note: The PUK is an eight-digit master code provided by your service provider.

- 3 Enter the new PIN code twice.

Locking/Unlocking the Keys/Buttons

Press MENU key and Left NAVIGATION key.



Note: The EMERGENCY button is not locked. Entering Emergency Mode unlocks all keys.

Related Links

[Keylock Setup](#) on page 68

Holding Your Radio

The radio has two microphones: a top microphone for simplex dispatcher/private calls and a bottom microphone for duplex telephone-like calls.

Also, the radio is equipped with an internal speaker for high audio (located at the middle of the unit) and an internal earpiece for low audio (located at the top of the unit). The audio can be routed either to the speaker or the earpiece using the Audio Toggle menu (MENU → **Setup** → **Audio** → **Audio Toggle**) or the assigned One-Touch Button.



Note: When possible, it is recommended to speak into the top microphone.

Simplex Calls

When using high audio, hold the radio a vertical position with its top microphone 5 centimeters to 10 centimeters away from your mouth. Speak into the top microphone. Listen through the internal speaker. Keep the antenna at least 2.5 centimeters from your head and body.

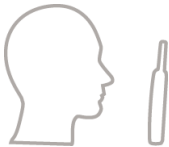

Duplex Calls

When using low audio, hold your radio as you would a telephone. Speak into the bottom microphone. Listen via the earpiece. Keep the antenna at least 2.5 centimeters from your head and body.



Lapel/Shoulder Use

For Group and Private Calls turn your head towards your shoulder/lapel, and speak directly into the top microphone. Listen through the internal speaker.

Speakerphone Use

Place your radio 30 centimeters to 60 centimeters away from you. In a noisy environment, you move the radio closer to you for better transmission.

Setting Flip Display

When and where to use:

The feature is useful for a user who has to wear the radio on a shoulder, belt, or lapel and at the same time wishes to read the display upside down.

Procedure:

- 1 From the home screen, press the **MENU** key.
- 2 Select **Setup** → **Display** → **Flip Display**.
- 3 Select one of the following:
 - **On** – to activate this feature.
 - **Off** – to deactivate this feature.

Entering TMO / DMO Mode

Procedure:

- 1 From the home screen, press **Optns**.
- 2 Select **Trunked Mode** / **Direct Mode**.

Related Links

[Selecting Network Operation Mode](#) on page 91

[Networks](#) on page 90

Transmit Inhibit Mode

The Transmit Inhibit Mode is a mode in which the radio sends no radio transmissions. It is recommended to activate the mode in RF sensitive areas, for example hospitals, airplanes, where safety can be jeopardized due to transmission radiation.

To activate, select **MENU** → **More . . .** → **Networks** → **TXI Mode** → **Activate**.

In this mode, the radio does not transmit under any circumstances except for the Emergency Calls. All the functions and keys which cause transmission, for example registration to the network, changing talkgroup or folder, sending SDS messages, or pressing the PTT button are disabled. Any transmission trial causes the radio to display **Not Allowed In TXI Mode** notification and to play a tone.

Your radio can still receive:

- Group calls.
- Messages — stored in the **Inbox**.
- Private call attempts — stored in the **Missed Calls** list, without the option to respond.

When no danger to safety exists anymore (for example, you leave the RF sensitive area), you can deactivate the Transmit Inhibit Mode and the radio returns to standard operation.

You can deactivate the mode by selecting MENU → **More . . .** → **Networks** → **TXI Mode** → **Deactivate**, pressing One-Touch button, or implicitly when initiating an Emergency Call.



Note: RF Transmissions from the radio are prevented under the following conditions:

- TXI Mode is activated.
- Battery is removed.
- The radio is turned off.

On entering or exiting the transmit inhibit mode, when the radio is camped on a cell, it sends a specially designated SDS status message. This SDS message indicates to the SwMI that the radio is entering or exiting transmit inhibit mode.

Mobility procedures that do not require the radio to send an uplink transmission are performed except for cell reselection.

In transmit inhibit mode the radio joins group calls for any group that the radio is monitoring, but the transmitting on that call is still prohibited.

The radio also displays any incoming SDS messages to the user. The missed call feature is active in the transmit inhibit mode and allows checking what calls were missed. However, the radio attempts to prevent call setup retransmission from being recorded as separate calls.

If you initiate an emergency call, the radio immediately leaves transmit inhibit mode and attempts to start the emergency call if the radio is in service.

If the radio is turned off in the transmit inhibit mode, on turning on the radio asks whether to exit the transmit inhibit mode. If you choose **No**, the radio turns off.

Selecting Talkgroups

From the home screen, use one of the following methods:

- Press left or right NAVIGATION key. Press **Select** to confirm.
- Select **Optns** → **TG by abc**. Enter a talkgroup name and select the talkgroup name from the list.
- Select **Optns** → **TG by Folder**. Select a folder and then a talkgroup name.
- Press ROTARY KNOB and rotate it until the required talkgroup name is displayed. Press **Select** to confirm.



Note: If the ROTARY KNOB mode is set to **Scroll**, then you do not need to press it to enter the scrolling mode.



Note: Your radio can have an access up to three levels of the folder structure.

Talkgroup Icon Selection

Table 8: Talkgroup Icon

| Icon | Description |
|---|---|
|  | Displayed when the talkgroup is from a different network than the one currently selected. |

Using Timed Talkgroup Change

This feature allows you to switch a selected talkgroup between the currently selected talkgroup and a predefined talkgroup (TMO or DMO), making the predefined talkgroup the selected talk group for a predefined time by using a One-Touch button. After the timer expires, your radio returns to the previously selected talkgroup.

Prerequisites: Timed Talkgroup Change is assigned to a One-Touch button.

Procedure:

- 1 Press and hold and hold the One-Touch button.
- 2 Your radio switches the selected talkgroup to the predefined talkgroup for a predefined amount of time.

During the predefined time the radio initiates or joins group communication (SDS, status SDS, or call) on the predefined talkgroup as the selected talkgroup.

Your service provider can assign a function to the second press of the One-Touch button to:

- Return to previously selected talkgroup
 - Restart the predefined time
 - No action
- 3 When the timer expires (potentially after being restarted a number of times) the radio switches to the previously selected talkgroup.

Activating Talkgroup Scanning

When and where to use: If you want to monitor any TMO Group Call in the defined talkgroup list.

Procedure:

- 1 From the home screen, press the MENU key.
- 2 Select **More . . .** → **Group Setup** → **Scan** → **Scanning**.
- 3 Select **Select List** and then a list name.
Your radio displays list name **Selected**.
- 4 Select **Scanning** → **On**.

Your radio is scanning on the predefined scan list.

Related Links

[Scan](#) on page 85

Dialing through Soft Numeric Keypad

Prerequisites: Direct Private Number Dialing is assigned to a right NAVIGATION key.

Procedure:

- 1 From the home screen, press and hold right NAVIGATION key.
Your radio displays dialing number prompt.
- 2 Rotate the ROTARY KNOB or press up/down NAVIGATION key to choose the number, then press the knob or right NAVIGATION key to go to the next digit.

**Note:**

- You can enter # at the end when the Speed Dialing feature is enabled.
- The + sign you can enter only when you are editing the first position. Both signs are available after digit 9.

3 Press the PTT or the SEND key (only in TMO).

Broadcast Call

The Broadcast Group Call (also called Site Wide Call) is a high-priority group call from the console operator (or dispatcher) to all users located at one or more sites. The radios are configured to monitor a Broadcast Call, but you cannot talk back. The call can be received as a normal Broadcast Call or an Emergency Broadcast Call. The Broadcast Call preempts an ongoing Group Call that has the same or lower call priority.

Ambience Listening (AL) Call

This feature allows a dispatcher to make a special call that allows listening to the conversations and background noises within the range of a particular radio's microphone. The call is set up without any indication to the affected radio, and any lower priority ongoing voice call may be preempted.

After accepting the call, the radio transmits in a simplex call without any action from or indication to the user. The Ambience Listening Call automatically ends when you initiate any voice call, switch to Emergency or TXI Mode, or send Emergency Alarm.

One-Touch Button Feature

The One-Touch Button feature allows for quick activation of functions by pressing and holding keys or buttons assigned to those functions.

Table 9: One-Touch Button Features

| Feature | Description |
|------------------------------------|---|
| Backlight Toggle | Toggles the backlight settings. |
| Change Audio Profile | Change to the specific audio profile. |
| Change Talkgroup | Changes the talkgroup to the programmed one by your service provider. |
| Covert Mode | Turns on/off the Covert Mode. |
| Direct Private Number Dialing | Dials a predefined private number. |
| Display Time | Displays universal time on the home screen. |
| Double Push PTT | Sends the D- PTT tone to the currently used talkgroup. |
| Enable/Disable Howling Suppression | Turns on/off Howling Suppression. |
| Extra Zoom On/Off | Turns on/off Extra Zoom. |
| Flip Display | Rotates the display by 180 degrees. |

Table continued...

| Feature | Description |
|---------------------------------|---|
| GPS Report | Sends a message with the radio's GPS location to a dedicated address. |
| Hi/Low Audio | Toggles high/low audio. |
| PABX Call | Initiates a PABX call to a predefined entry in the contact list. |
| Phone Call | Initiates a phone call to a predefined entry in the contact list. |
| Previous Talkgroup | Changes the selected talkgroup of the radio to the talkgroup (DMO or TMO) that was selected previously. |
| Private Call | Initiates a private call (simplex or duplex) to a predefined entry in the contact list or to the last group call originator. |
| Rotary Switches Lock/Unlock | Locks/unlocks the Rotary Switches. |
| Screen Saver Activation | Turns on/off the Screen Saver feature. |
| Scroll Audio Profiles | Scrolls through all available audio profiles. |
| Sending Predefined Message | Sends a predefined message to a dedicated address. |
| Sending Status | Sends a dedicated status message to a dedicated address. |
| Sending User Defined Message | Sends a user defined message to a dedicated address. |
| Speaker Enable/Disable Per Call | Enables the loudspeaker for a duration of the ongoing call.. |
| Timed Talkgroup Change | Makes a predefined talkgroup the selected talk group for a specified amount of time. While using the predefined talkgroup, the second press of the One-Touch Button results in: returning to the previously selected talkgroup, restarting the predefined time, or no action (depending on configuration). After the timer expires, the radio returns to the previously selected talkgroup. |
| TMO / DMO Switch | Toggles between TMO and DMO modes. |
| TMO Talkgroup Scan | Turns on/off the Talkgroup Scan feature in TMO Mode. |
| Transmit Inhibit Mode (TXI) | Turns on/off the Transmit Inhibit Mode. |
| Volume Down | <ul style="list-style-type: none"> • Press to decrease the volume by one level. • Press and hold to continuously decrease the volume to its minimum level. |
| Volume Up | <ul style="list-style-type: none"> • Press to increase the volume by one level. • Press and hold to continuously increase the volume to its maximum level. |

Your service provider can assign one-touch functions only to the side buttons and keypad keys.

Terminal Temporary Disable/Enable

Your radio is provided with a feature that allows your service provider to disable it temporarily in case it is stolen. When your radio is disabled or is powered up in disabled state, it looks and acts like it is turned off.

If your radio is found, your service provider can enable it again over the air. After your radio is enabled, you may resume normal operation.

Terminal Permanent Disable

Your radio is provided with a feature that allows your service provider to disable it permanently in case it is stolen or lost. When your radio is disabled permanently, it becomes inoperable. After a Permanent Disable your service provider cannot enable your radio. It is recommended to Permanent Disable your radio only when you do not expect to recover it. If it is recovered then a Permanent Disable radio can be reactivated by returning it to Motorola.



Note: This is a selling feature.

High/Low Audio Toggle

The user is able to switch from the external earpiece to the main speaker using **SPEAKER CONTROL** key and is not required to disconnect the external earpiece or PHF.

The states of the routed audio are:

- **Speaker HIGH** — indicates that audio is routed to the main speaker.
- **Speaker LOW** — indicates that audio is routed to the earpiece or PHF earpiece, and not to the main speaker.

Using High Audio

When and where to use: Use it when placing and receiving a Group, Phone and Private calls.

Procedure:

- 1 Hold your radio in a vertical position with its top microphone 5–10 centimeters away from your mouth.
- 2 Speak into the top microphone and listen through the internal speaker.
Keep the antenna at least 2,5 centimeters from your head and body.

Using Low Audio

When and where to use: Use it when placing and receiving a Phone, PABX, and Duplex Private calls.

Procedure:

- 1 Hold your radio as you would a telephone.
- 2 Speak into the bottom microphone and listen through the earpiece.
Keep the antenna at least 2,5 centimeters from your head and body.

During the Call

During the call, label of the right **SOFT** key indicates the next possible change. Accessory default setup is:

Table 10: During the Call

| Soft Key Label | Audio Setting |
|----------------|--|
| Spkr | Audio goes to the main speaker (Speaker HIGH is displayed) |
| Erpce | Audio goes to the earpiece (Speaker LOW is displayed) |
| PHF | Audio goes to the Personal Hands Free (Speaker LOW is displayed) |

Writing Text

Every time that you see text entry screen, refer to this section.

To enter text, use the ROTARY KNOB or the up/down NAVIGATION key.

To change the text entry mode, press and hold the right NAVIGATION key or press and hold the ROTARY KNOB.

Related Links



[Unlocking Your Radio](#) on page 28

Text Entry Icons

In the text entry screen, icons tell you which text entry mode and method you are using. A character counter displayed on the text entry icon, indicates the amount of characters that can be entered.

Press and hold right NAVIGATION key or press and hold ROTARY KNOB to toggle through the text entry modes.

Table 11: Text Entry Screen Icons

| Icons | Description |
|---|--|
|  | A-Z – all capitals |
|  | a-z – no capitals |
|  | Enter numbers and symbols: 0-9 # \$ % & ^ ~ \ } { [] [¢ ¥ \$ £ € > < = * × % & + ; _ : /) (- ' ' @ ! ? , . |

Keys Usage

Table 12: Keys Usage

| Key | Description |
|----------------------|--|
| Send | Press to send the message. You have a choice to send it to a Private user or a Group. |
| Delete | <ul style="list-style-type: none"> Press once to delete the highlighted character. Press and hold to clear the entire main text area. |
| Up NAVIGATION key | Press to scroll through the letters, or numbers or symbols. |
| Down NAVIGATION key | Press to scroll through the letters, or numbers or symbols. |
| Right NAVIGATION key | <ul style="list-style-type: none"> Press to navigate to the right. Press and hold to change entry mode. Press to add a new letter at the end of the text (a, A or 0). |
| Left NAVIGATION key | Press to navigate to the left. |
| MENU | Opens the Editor Menu to store the message as a template or save changes. |
| ROTARY KNOB | <ul style="list-style-type: none"> Press to add new letter (a, A or 0). Press and hold to change entry mode. Rotate to scroll through the letters, or numbers or symbols. |

Home Display Text Message

Your radio is provided with a feature that allows your service provider to send special text messages to the display. The message stays on the home screen until a new message is received. Power cycle your radio to replace the Home Display message to the predefined one.

Chapter 3

Modes

This chapter contains information on available modes that the radio can operate in.

Using Networks

Procedure:

- 1 From the home screen, press the `MENU` key.
- 2 Select **More . . .** → **Networks**.
- 3 Select one of the following:
 - **Trunked Mode**
 - **Direct Mode**
 - **TXI Mode**

Your radio switches to the selected mode.

Trunked Mode Operation

Trunked Mode Operation requires the switching and management infrastructure. This operation mode enables various voice and data communication types (for example, group calls, short data service messages) and access to the infrastructure-related features (for example, packet data).

Figure 1: Trunked Mode Operation

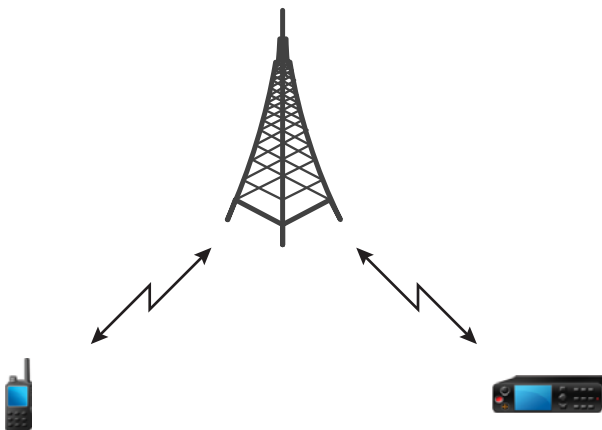

Entering TMO Mode

Procedure:

- 1 From the home screen, press **Optns**.
- 2 Select **Trunked Mode**.

Selecting Talkgroups

From the home screen, use one of the following methods:

- Press left or right NAVIGATION key. Press **Select** to confirm.
- Select **Optns** → **TG by abc**. Enter a talkgroup name and select the talkgroup name from the list.
- Select **Optns** → **TG by Folder**. Select a folder and then a talkgroup name.
- Press ROTARY KNOB and rotate it until the required talkgroup name is displayed. Press **Select** to confirm.



Note: If the ROTARY KNOB mode is set to **Scroll**, then you do not need to press it to enter the scrolling mode.



Note: Your radio can have an access up to three levels of the folder structure.

Making Group Calls in TMO

The Group Call is received by all members of the selected group who have their units turned on and are in range.

Procedure:

- 1 Press and hold the PTT button.
- 2 Wait for the *Talk Permit* tone (if configured) and then speak into the microphone. Release the PTT button to listen.



Note: To cancel making a group call, do one the following actions before the talk permit is granted (depending on your service provider's settings):

- Release the PTT button.
- Press the END key (default).

When the call is canceled, your radio displays **Call Cancelled** message (if configured by your service provider).

Receiving Group Calls in Idle

Procedure:

- 1 The radio receives a Group Call.



Note: The incoming Group Call is signalled by a *Receiving Group Call* tone.

- 2 To respond, press and hold the PTT button.

Receiving Group Calls during Ongoing Group Calls

While in active Group Call, your radio receives a Group Call with a higher priority.

One of the following occurs:

- Your radio is forced to end the current group call and automatically join the incoming one.
- Your radio displays incoming group call screen with options:
 - **Join** — ends current Group Call and starts the incoming one.

- **End** — cancels the incoming Group Call.

Dynamic Group Number Assignment (DGNA)

DGNA allows the network operator to dynamically manage talkgroups on your radio over the air interface. Using DGNA, the network operator can:

- Add talkgroups.
- Attach or select newly added talkgroups.
- Delete talkgroups.
- Modify parameters of existing talkgroups.

All the above operations are performed by transmitting data to your radio.

DGNA Reception

When a DGNA message is received, your radio plays a tone and displays a message **Talkgroup list updated**. If enabled by your service provider, your radio displays all added and deleted talkgroup list.

When your service provider deletes (de-assigns) the currently selected talkgroup, depending on the settings, the radio can perform one of the following actions:

- Enter the “No Group” state – the radio does not attach to any talkgroup automatically.
- Attach to the last selected TMO talkgroup. If the last selected TMO talkgroup is not available (it was deleted), the radio enters the “No Group” state.
- Attach to a default talkgroup configured by your service provider. If the default talkgroup is not available (it was deleted), the radio enters the “No Group” state.

At each talkgroup change, an appropriate notification is shown on the display.

If the DGNA message is received to delete all talkgroups, your radio displays **All Talkgroups Deleted**. To exit the DGNA display, you can use the **BackSOFT** key or the **END** key.

DGNA Auto Select Group

If the DGNA Auto Select is configured, whenever your radio receives a DGNA, it switches to the added talkgroup.

DGNA Auto Reselect Group

If the DGNA Auto Reselect is configured, whenever a talkgroup assigned by the network operator via DGNA is deassigned without the user action, the radio returns to the previously selected group.

Viewing DGNA Talkgroups

Prerequisites: Your radio receives the DGNA message.

Procedure:

- 1 To view the added talkgroups details press **View**.
- 2 Scroll through the list to select required talkgroup.
- 3 To select the DGNA group, press **Attach**.

Broadcast Calls Initiated by Users

This feature allows you to make a Broadcast Call from the radio that is initiated on the predefined talkgroup. Your service provider predefines the alias and the priority of the Broadcast Call.



Note: If the type of the encryption is defined by the SIM Card, the Broadcast Call is always clear. Otherwise if the radio uses other encryption service the type of the encryption used for that Call is up to the encryption settings of that service.



Note: This feature is not supported on the Dimetra infrastructure.

Initializing Broadcast Calls

Procedure:

- 1 From the home screen, press the `MENU` key.
- 2 Select **More . . .** → **Services** → **Broadcast**.
Your radio displays the predefined alias and the Broadcast Call icon.
- 3 To start the call press the PTT button.

Phone and PABX Calls

The Phone Call allows you to call a landline telephone number or a cellular mobile phone number. The Private Automatic Branch Exchange (PABX) Call allows you to call local (office) extension numbers.

Private Call

The Private Call, also called point-to-point, or individual call, enables calling between two individuals. No other radio can hear the conversation. This call type can be carried out in two ways:

- Duplex call (if the system allows), in TMO Mode. Both parties can speak at the same time.
- Simplex call, in TMO or DMO Mode. Only one party can speak at a time.

When a DMO Private Call takes place, radios not involved in this call receive the channel busy indication. The radios are identified using its radio numbers.

Related Links

[Emergency Individual Calls \(Private or MS-ISDN\)](#) on page 50

Making Private Calls

Prerequisites: Direct Private Number Dialing is assigned to the right `NAVIGATION` key.

Procedure:

- 1 From the home screen, press and hold the right `NAVIGATION` key and enter a number.
- 2 If **Private** is not the first type of call presented, press **Ctype** repeatedly to select it.
- 3 When you are in the following mode:
 - a TMO — For simplex calls, press and release the PTT button. You hear a ringing tone. Otherwise, press and hold the PTT button. Wait for the talk permit tone before talking, and release the PTT button to listen. For duplex calls, press and release the `SEND` key. You hear a ringing tone.
 - b DMO — Only simplex calls are available. Press and hold the PTT button. Wait for the talk permit tone before talking, and release the PTT button to listen.
- 4 To end the call, press the `END` key.

Assistance Call

This feature allows you make a private call to ask for assistance during normal and non-critical situations.



Note: Your service provider can configure the number, priority, and the type of the call (simplex or duplex).

You can start an Assistance Call in one of the following way:

- Dial a predefined number and press `SEND` key.

- **Menu** → **More . . .** → **Services** → **Assistance Call**

Call Modification

Call Modification is a feature that allows your service provider to modify the call in order to optimize it and adjust to a current situation.

Modification can cover:

- Call priority — modified during call setup.
- Call type — modified during call setup.
- Call encryption — modified during an ongoing call (but not in the transmission phase).

When the call is modified, your radio displays **Call Modified** message.

When a recently modified call requires the PTT button to transmit, your radio displays **Call Modified Use PTT**.

All modifications are made by your service provider and the radio only follows them. You have no influence on ongoing call modifications.

When call priority is changed to emergency:

- The display indicates that an Emergency Group Call has been received.
- The radio plays a special audio alert.



Note: If a Group Call is modified into an Emergency Group Call, no emergency related features are triggered.

If call modification requested by your service provider cannot be followed by the radio (due to its settings), the radio rejects it and displays **Service Not Available** message.

Local Site Trunking

This mode is also called as Fallback Mode and it allows more than one radio from the same site to communicate when the link between the site and the network central controller fails. Entering and exiting Local Site Trunking (that is, returning to System Wide Services) is done automatically. In this mode some services are unavailable.



Note: Your service provider can disable this mode.

Entering Local Site Trunking

When your radio receives a Local Site Trunking indication from the system, the following occurs:

- Your radio plays an Entering Local Site Trunking tone.
- Display shows the **Local Area Service** message.
- Display icons and soft keys turn olive.



Note: Noticeable only on the color display.

- Any call in progress is dropped upon entering Local Site Trunking Mode.

If configured by your service provider, this message/alert is periodically repeated to remind you that your radio is still operating in Local Site Trunking Mode. The following features are available:

- Registration
- Attachment
- Group Call
- Emergency Call

- Emergency Alarm



Note: Your service provider can turn on/off all the visual and audio indications, when you enter Local Site Trunking Mode.

Exiting Local Site Trunking

When the link with the central network controller is reestablished, your radio exits Local Site Trunking, and the following occurs:

- Your radio plays an Exiting Local Site Trunking tone.
- Any call in progress during Local Site Trunking is dropped.
- Display icons and soft keys turn blue.



Note: Your service provider can turn on/off all the visual and audio indications, when you exit Local Site Trunking Mode.

Direct Mode Operation

Direct Mode Operation is a mode of simplex operation where radios communicate directly.

Figure 2: Direct Mode Operation

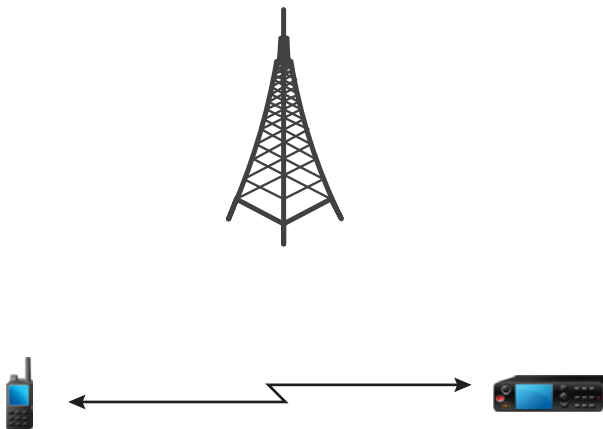

Entering DMO Mode

To enter the DMO Mode:

- From the home screen, press the **MENU** key. Select **More . . .** → **Networks** → **Direct Mode**.
- From the home screen, select **Optns** → **Direct Mode**.

Selecting Talkgroups

From the home screen, use one of the following methods:

- Press left or right **NAVIGATION** key. Press **Select** to confirm.
- Select **Optns** → **TG by abc**. Enter a talkgroup name and select the talkgroup name from the list.
- Select **Optns** → **TG by Folder**. Select a folder and then a talkgroup name.
- Press **ROTARY KNOB** and rotate it until the required talkgroup name is displayed. Press **Select** to confirm.



Note: If the ROTARY KNOB mode is set to **Scroll**, then you do not need to press it to enter the scrolling mode.



Note: Your radio can have an access up to three levels of the folder structure.

Making Group Calls in DMO

The Group Call is received by all members of the selected group who have their units turned on and are in range.

Procedure:

- 1 Press and hold the PTT button.
- 2 Wait for the *Talk Permit* tone (if configured) and then speak into the microphone. Release the PTT button to listen.

Receiving Group Calls in Idle

Procedure:

- 1 The radio receives a Group Call.



Note: The incoming Group Call is signalled by a *Receiving Group Call* tone.

- 2 To respond, press and hold the PTT button.

Private Call

The Private Call, also called point-to-point, or individual call, enables calling between two individuals. No other radio can hear the conversation. This call type can be carried out in two ways:

- Duplex call (if the system allows), in TMO Mode. Both parties can speak at the same time.
- Simplex call, in TMO or DMO Mode. Only one party can speak at a time.

When a DMO Private Call takes place, radios not involved in this call receive the channel busy indication. The radios are identified using its radio numbers.

Related Links

[Emergency Individual Calls \(Private or MS-ISDN\)](#) on page 50

Making Private Calls

Prerequisites: Direct Private Number Dialing is assigned to the right NAVIGATION key.

Procedure:

- 1 From the home screen, press and hold the right NAVIGATION key and enter a number.
- 2 If **Private** is not the first type of call presented, press **Ctype** repeatedly to select it.
- 3 When you are in the following mode:
 - a TMO — For simplex calls, press and release the PTT button. You hear a ringing tone. Otherwise, press and hold the PTT button. Wait for the talk permit tone before talking, and release the PTT button to listen. For duplex calls, press and release the SEND key. You hear a ringing tone.
 - b DMO — Only simplex calls are available. Press and hold the PTT button. Wait for the talk permit tone before talking, and release the PTT button to listen.
- 4 To end the call, press the END key.

Private Call With Presence Check

This feature allows you to see if the calling party is available in DMO. When this feature is enabled, you can only initiate a Private Call if the called radio is present on the same channel and responds with a presence check acknowledgement.

Otherwise your radio displays **Party Not Available**.

Talkgroup for Individual Calls

Talkgroup for Individual Calls is a talkgroup that operates on a separate frequency allocated for individual (private) calls only. Using this talkgroup optimizes frequency resources and helps not to block other talkgroups. The only supported call types are: private calls and emergency calls (both private and group). Use this talkgroup each time you need to make a private call.

When you select a Talkgroup for Individual Calls, your radio is not able to receive or initiate any group or broadcast calls with priority lower than Emergency.

When you have selected a Talkgroup for Individual Calls and press the PTT button to start a Group Call, the radio:

- Rejects the call
- Plays a tone
- Displays the **Individual Calls Only** message

Communication through Repeaters

Radios that are out of range and cannot communicate directly one with another in DMO Mode can do it through the repeater. The repeater is a radio that repeats all communication on a chosen channel, and as a result increases radios' DMO range.

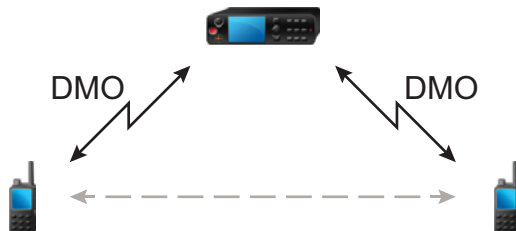

When the radio connects to a repeater, it plays a tone, displays the **Repeater available** message, and shows an appropriate icon. When the radio loses connection with the repeater, it plays a tone, displays the **Repeater not available** message, and the repeater icon is blinking.

Communication through Gateways

Gateway provides connectivity between radios operating in DMO Mode and the TETRA network, so that the DMO radios can communicate with the TMO radios.

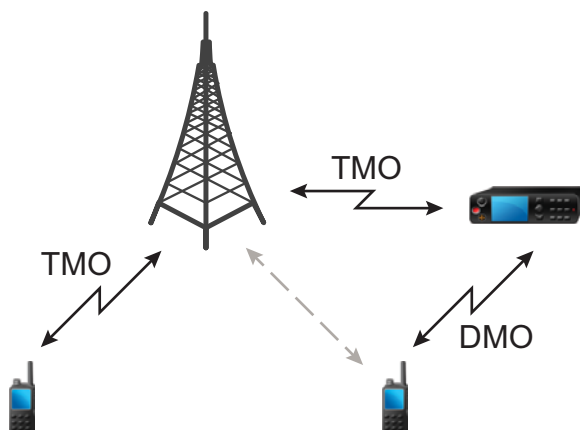

When the radio connects to a gateway, it plays a tone, displays the **Gateway available** message and shows an appropriate icon. When the radio loses connection with the gateway, it plays a tone, displays the **Gateway not available** message, and the gateway icon is blinking.

Selecting DMO Group Call Options

When and where to use: Helps to communicate with other radio users on the same talkgroup through the Gateway or Repeater.

Procedure:

- 1 From the home screen, press **Optns**.
- 2 Press **Config**.
- 3 Select one of the following:
 - **MS - MS** — Your radio can communicate only with other radios within its range.
 - **Gateway** — Your radio uses a gateway to communicate with the infrastructure.
 - **Automatic** — Your radio uses the first available gateway for that talkgroup.
 - **Specific** — Your radio uses only the Gateway with the specified Gateway address for that talkgroup. If your radio displays **Selected Gateway:None**, press **Edit** to enter the current gateway address.
 - **Repeater** — Uses the first available repeater for that talkgroup.
 - **GW + Rep** — Uses the first available gateway or repeater for that talkgroup.
 - **Automatic** — Uses the first available gateway for that talkgroup.
 - **Specific** — Uses only the Gateway with the specified Gateway address for that talkgroup. If your radio displays **Selected Gateway:None**, press **Edit** to enter the current Gateway address.



Note: When the Gateway and the Repeater cannot be communicated even though a talkgroup to use them is configured, the radio attempts the direct MS-MS communication.

When your radio detects the appropriate Gateway and/or the Repeater, the Gateway and/or Repeater icons turns solid, respectively.

Transmit Inhibit Mode

The Transmit Inhibit Mode is a mode in which the radio sends no radio transmissions. It is recommended to activate the mode in RF sensitive areas, for example hospitals, airplanes, where safety can be jeopardized due to transmission radiation.

To activate, select MENU → **More . . .** → **Networks** → **TXI Mode** → **Activate**.

In this mode, the radio does not transmit under any circumstances except for the Emergency Calls. All the functions and keys which cause transmission, for example registration to the network, changing talkgroup or folder, sending SDS messages, or pressing the PTT button are disabled. Any transmission trial causes the radio to display **Not Allowed In TXI Mode** notification and to play a tone.

Your radio can still receive:

- Group calls.
- Messages — stored in the **Inbox**.
- Private call attempts — stored in the **Missed Calls** list, without the option to respond.

When no danger to safety exists anymore (for example, you leave the RF sensitive area), you can deactivate the Transmit Inhibit Mode and the radio returns to standard operation.

You can deactivate the mode by selecting MENU → **More . . .** → **Networks** → **TXI Mode** → **Deactivate**, pressing One-Touch button, or implicitly when initiating an Emergency Call.



Note: RF Transmissions from the radio are prevented under the following conditions:

- TXI Mode is activated.
- Battery is removed.
- The radio is turned off.

On entering or exiting the transmit inhibit mode, when the radio is camped on a cell, it sends a specially designated SDS status message. This SDS message indicates to the SwMI that the radio is entering or exiting transmit inhibit mode.

Mobility procedures that do not require the radio to send an uplink transmission are performed except for cell reselection.

In transmit inhibit mode the radio joins group calls for any group that the radio is monitoring, but the transmitting on that call is still prohibited.

The radio also displays any incoming SDS messages to the user. The missed call feature is active in the transmit inhibit mode and allows checking what calls were missed. However, the radio attempts to prevent call setup retransmission from being recorded as separate calls.

If you initiate an emergency call, the radio immediately leaves transmit inhibit mode and attempts to start the emergency call if the radio is in service.

If the radio is turned off in the transmit inhibit mode, on turning on the radio asks whether to exit the transmit inhibit mode. If you choose **No**, the radio turns off.

Emergency Operations

Emergency Operations are used in critical situations.

Pressing and holding the EMERGENCY button, or entering the Emergency Number and pressing the SEND key, activates one or more services (depending on your service provider settings):

- Emergency Alarm
- SDS Status
- Silent Emergency
- Hot Microphone operation
- Emergency Individual Call (Private or MS-ISDN)
- GPS location information



Note: It is possible to turn on the radio by pressing the EMERGENCY button. Depending on the service provider settings, the radio can start Emergency Operations automatically. If the radio is PIN-protected (except for SIM PIN), Emergency Operations will bypass the PIN lock for the duration of the Emergency Operations.

When starting Emergency Operations, any ongoing voice call is aborted or cleared down, and any packet data transfer in progress is aborted. However, the session is kept open.

During Emergency Operations, the radio rejects phone, PABX, and private calls, and does not monitor the talkgroups in the selected scan list.

To terminate Emergency Operations, press the rightSOFT key.

Emergency Group Call

The Emergency Group Call has the highest communication priority that means it is the pre-emptive kind of call. Emergency Group Call is available in both TMO and DMO. During Emergency Operations, Emergency Group Call can be started by pressing the EMERGENCY button. The radio can also support Hot Microphone operation, which allows the Emergency Call to be conducted without pressing the PTT button.

If the radio receives an incoming group call with emergency priority, the display shows that an emergency call has been received, and a special audio alert is played.

An emergency group call can be configured as:

- A non-tactical call – initiated on a talkgroup preprogrammed by your service provider. When in non-tactical emergency mode, you cannot switch talkgroups.
- A tactical call – initiated on the currently selected talkgroup.

In TMO, if the radio enters Emergency Operations while the Emergency Broadcast Call is active, the radio continues on the call without initiating any calls and sends the Emergency Alarm.

When the Emergency Group Call you participate in terminates, your radio can behave in several ways, depending on your service provider settings:

- If you are the call initiator, the radio can either stay in the Emergency Mode, or return to TMO.
- If you are not the call initiator, the radio always returns to TMO.

Making Emergency Group Calls

Prerequisites: Ensure that your radio is in Emergency Mode.

Procedure:

- 1 Press and hold the PTT button.
- 2 Wait for the talk permit tone (if configured) and talk.
- 3 Release the PTT button to listen.



Note: It is possible to cancel making an emergency group call in TMO. To do this, perform one of the following actions before the talk permit is granted (depending on your service provider settings):

- Release the PTT button.
- Press the END key (default).

When the call is canceled, your radio displays **Call Cancelled** message (if configured by your service provider).

Receiving Emergency Group Calls

The radio receives an Emergency Group Call from a selected pre-programmed group. An incoming call is indicated by an appropriate tone, status icon, and red color of the display.

Non-Tactical Emergency

In Non-Tactical Emergency, the radio switches to a designated Emergency talkgroup when starting Emergency Operations. This talkgroup is used for the complete duration of the Emergency Operations (you cannot change the talkgroup).

In TMO, it is possible to configure the radio to make Emergency Non-Tactical Group Calls without sending attachment. If this is set, the radio assumes implicit attachment after receiving a temporary address.

In DMO, the Non-Tactical Emergency proceeds on the same frequency as the previously selected talkgroup. The service provider can designate any ITSI address to be used for Emergency Operations, (this can be an Open Group – broadcast address).

After exiting from Non-Tactical Emergency, the radio goes back to the previously selected talkgroup.

Emergency Individual Calls (Private or MS-ISDN)

The Emergency Individual Calls are Simplex or Duplex Calls with emergency priority. On pressing the EMERGENCY button, the radio initiates an Individual Call to the provisioned address (private or MS-ISDN). During this kind of call all user indications are unavailable and all other services are rejected. Emergency Operation ends as soon as the Emergency Individual Call is ended.

Related Links

[Private Call](#) on page 42

Emergency Alarm

The Emergency Alarm is a special status message sent to the infrastructure while starting the Emergency Operations. The radio can wait for infrastructure acknowledgment for this alarm and attempts retries.

Each time the radio enters the Emergency Operation, it sends the Emergency Alarm. When the Emergency Alarm is sent successfully, the respective audible tone sounds.

In addition, once the radio is in the Emergency Operation on pressing the EMERGENCY button, an additional emergency alarm is sent (exception: during Hot Microphone transmission).

The message can be dispatched both in TMO and DMO.

Emergency SDS Status

Radio sends a status message with a preprogrammed value to the destination address set by your service provider. Emergency SDS Status is available in TMO only. If no status acknowledgment or negative acknowledgment is received, the radio retries sending the message. Status is not resend if Emergency Alarm or Hot Microphone is configured.

Emergency Hot Microphone

The Hot Microphone allows you to talk without pressing the PTT button during Emergency Operations. The transmission continues for a provisioned amount of time. Pressing the PTT button before the Hot Microphone time expires ends the Hot Microphone operation. Then normal PTT operation in Emergency group call takes over (that is, the transmission is ongoing for the time the PTT button is held).

Subsequent EMERGENCY button presses during the Emergency Operation restarts the Hot Microphone transmission.

If a talk permit is granted to another member of the group, the Emergency Call received tone is played. If configured, the radio automatically attempts to get talk permit again.

Pressing **EndSOFT** key or END key ends the Hot Microphone operation.

Alternating Hot Microphone

The Alternating Hot Microphone is an enhancement of the Hot Microphone. After activation, the radio alternately enters transmission phases (your microphone is active) and reception phases (you can only listen) for an amount of time precisely determined by your service provider.

If this feature is enabled, you can initiate the Alternating Hot Microphone by pressing the **EMERGENCY** button. If you want to finish earlier or skip the transmission phase, press the **END** key.

The Alternating Hot Microphone terminates when one of the following conditions is met:

- The radio exits the Emergency Mode.
- The Alternating Hot Microphone timer expires.
- The **PTT** button is pressed.
- The right **SOFT** key is pressed (only during the transmission phase).



Note: When the radio goes out of the service, it enters the reception phase and the Alternating Hot Microphone is on hold. When the radio is back to the service, the Hot Microphone transmission and the Alternating Hot Microphone resume.



Note: When you are in the Emergency Mode, pressing the **EMERGENCY** button restarts the Alternating Hot Microphone.

Silent Emergency Mode

The Silent Emergency Mode is a type of emergency services that provides no audible indications and no keypad tones at the entrance. All the display indications are as in the home mode. However, the radio cannot use any services except for:

- Receiving Ambience Listening
- Sending Silent Emergency Alarms
- Sending GPS location reports



Note: If you try to activate any other feature, it is blocked.

If the Silent Emergency feature is enabled, the radio enters Silent Emergency Mode on pressing the **EMERGENCY** button. After entering this Mode the radio stays in TMO or switches to it, depending on the actual state. Once in TMO, the radio sends Silent Emergency Alarm.



Note: If the radio is in a private or group call, the radio waits until the call ends and then enters the Silent Emergency Mode.

The radio keeps re-sending the alarm until successful sending is confirmed. After the alarm is successfully delivered, the radio stays in Silent Emergency Mode and waits for the Ambience Listening.

Your radio exits the Silent Emergency Mode, under the following conditions:

- Press **MENU** and then **#** key within 3 seconds.
- Press **MENU** simultaneously with right **NAVIGATION** key.
- Press both **SOFT** keys simultaneously.
- No success in sending the Silent Emergency Alarm and the maximum number of retries has been reached.
- The control room terminates the Silent Ambience Listening.
- The Ambience Listening is disconnected due to another reason.

If you turn off the radio in the Silent Emergency Mode, the radio switches to pseudo power off state. In this state, the radio appears to be turned off. However, the radio is still on and in the Silent Emergency Mode. On turning the radio on during the pseudo power off state, the radio acts as during turning on and still is in the Silent Emergency Mode.

Invisible Emergency

It is possible for the service provider to disable visual and audible indications of performing Emergency Operations on the radio. The purpose of this feature is to hide the fact of using Emergency Operations in a critical situation (e.g. direct attack on the user) and thus to provide additional layer of safety.

Disaster Alert

Disaster Alert call is a broadcast emergency call initiated by the radio, with emergency pre-emptive priority that everyone in a broadcast area can hear. This feature is specifically designed for catastrophic situations, such as earthquakes, and has the highest priority over other calls. All radios under Disaster Alert display emergency notification on their screens. The alert message, its duration and destination talkgroup can be configured in the codeplug.

In order to initiate Disaster Alert, switch the radio to Disaster Alert mode and press PTT button. When the call ends, the radio will exit the Disaster Alert state.

During Disaster Alert, other functionality is impacted:

- When Disaster Alert begins, any other ongoing services are terminated.
- No other services can interrupt this type of call.
- Hot Mic functionality cannot be used.
- Speech can only be in Clear mode, even if any of the encryption services are enabled. The only exception is E2E Encryption.



Note: Not all infrastructures support this feature. Please consult with your service provider before enabling this feature.

Initializing Disaster Alert Calls

Procedure:

- 1 From the home screen, press the **MENU** key.
- 2 Select **More . . .** → **Services** → **Disaster Alert**.
Your radio enters Disaster Alert Mode and it displays Disaster Alert icon.
- 3 To start the call press PTT.
Your radio displays **Disaster AlertIn Use**.

Exiting Emergency Operations

Prerequisites: Make sure that your radio is engaged in Emergency Operations.

Procedure:

- 1 If your radio screen displays **Emergency Mic On**, press **End**.
- 2 Press and hold **Exit**.
- 3 If your radio displays **Do you want to exit?**, press **Yes** to exit.

Your radio exits Emergency Operations.

Chapter 4

GPS Location Service

The GPS Location Service feature uses information from Global Positioning System (GPS) satellites orbiting the Earth to determine the approximate geographical location of your radio.

The GPS Location Service availability, accuracy, and the position calculation time vary depending on the environment in which you use the radio. The GPS Location Service can assist your dispatcher or colleagues in many ways such as more efficient deployment of resources or locating your radio when you trigger your emergency service.

The radio can display the location information directly on the screen or send it over the air to your dispatcher to display it in the control center. Check your radio configuration details with your service provider.



Important: Where the signals from satellites are not available, the GPS Location Service does not work. This situation usually happens when your radio cannot establish a view of a wide area of open sky, for example, when the GPS antenna is covered or facing the ground. Such situations include being:

- In underground locations
- Inside buildings, trains, or other covered vehicles
- Under any other metal or concrete roof or structure
- Near a powerful radio or television tower
- In extreme temperature outside the operating limits of your radio

Even if your location information can be calculated in such situations, it may take longer to do so. Therefore, in any emergency situation, always report your location to your dispatcher. Where adequate signals from multiple satellites are available, your GPS Location Service feature provides a location, most probably near to your actual location.

The radio can be triggered to send Location Reports in various circumstances, for example:

- Upon a request
- Entering Emergency Mode
- At specified time intervals
- At specified distance intervals

The Location Reports can be sent both in TMO and DMO by using:

- SDS messages
- Packet Data

The radio can be configured to give audio-visual notifications upon sending the Location Reports.

Depending on the radio settings, viewing the radio position and the status of the visible satellites is available. The position may consist of longitude and latitude, UK, or Irish grid coordinates.



Note: This is a selling feature.

Related Links

[Location](#) on page 92

Enhancing GPS Performance

Sometimes the GPS feature is unable to complete a location calculation successfully. You hear an audible tone indicating that your radio cannot see the satellites.

To maximize the ability of your radio to determine a location fix please note the following guidelines:

- Stay in the open — The GPS feature works best where there is nothing between your radio and a large amount of open sky. If possible, go outside, away from tall buildings and foliage. While the performance in a building is improved by moving closer to windows, glass with certain sun shielding films may block satellite signals.
- Position your radio to enhance reception — Signals from GPS satellites are transmitted to your GPS antenna, which is in your radio antenna. Hold your radio away from your body, giving the antenna clear access to satellite signals. Do not cover the antenna area with your fingers or anything else.
- Stand still — If possible, stand still until your radio is finished determining your location. Moving your radio at a walking pace while your radio is calculating your approximate location may substantially decrease GPS performance.

Enabling GPS

Procedure:

- 1 From the home screen, press the MENU key.
- 2 Select **More . . .** → **Location** → **Interface**.
- 3 Select **On**.



Note: Your service provider can enable this feature.

GPS Icon

When GPS is enabled, the following icon is displayed in the status icon area:  Depending on the current GPS state, the icon can be solid – GPS has a fix, or blinking – GPS is searching for a fix. The blinking GPS icon can be disabled/enabled by your service provider.

GPS Different Location Displays

Table 13: Different Location Displays

| Latitude / Longitude | UK Coordinates | Irish Coordinates | UTM Coordinates | MGRS Coordinates |
|----------------------|---------------------------------|---------------------------------|---------------------------------|---------------------------------|
| Time | Time | Time | Time | Time |
| Latitude | 2–Letter Code | 1–Letter Code | 3–Letter Code | 3–Letter Code and 2–Letter Code |
| Longitude | Easting and Northing Coordinate | Easting and Northing Coordinate | Easting and Northing Coordinate | Easting and Northing Coordinate |
| Altitude | Altitude | Altitude | Altitude | Altitude |

Table continued...

| Latitude / Longitude | UK Coordinates | Irish Coordinates | UTM Coordinates | MGRS Coordinates |
|----------------------|----------------|-------------------|-----------------|------------------|
| Satellites | Satellites | Satellites | Satellites | Satellites |

- Time — indicates when the last time the location was calculated. The time is provided in Universal Time Coordinated.
- Letter Code — grid zone or square on the map for different coordinate standard
- Latitude — expressed in degrees, minutes, and seconds.
- Longitude — expressed in degrees, minutes, and seconds.
- Number of satellites — used to calculate the location. In general, more satellites make for better accuracy. The maximum is 12 satellites.
- Easting — refers to the eastward-measured distance expressed in meters.
- Northing — refers to the northward-measured distance expressed in meters.



Note: Skipping each digit of easting and northing coordinates decreases the accuracy by the factor of 10.

Viewing Your Position

Procedure:

- 1 From the home screen, press the MENU key.
- 2 Select **More . . .** → **Location** → **Position**.
- 3 Scroll to view the results about the last time your location was calculated.



Note: To refresh your position:

- Select **Position** — the radio refreshes its position automatically
- Press **Refresh**

Changing GPS Accuracy

Procedure:

- 1 From the home screen, press the MENU key.
- 2 Select **More . . .** → **Location** → **Accuracy**.
- 3 Select one of the following:
 - **Medium** (default) — Power consumption optimization is combined with less position accuracy.
 - **High** — Better position accuracy is combined with less power consumption optimization.



Note: If connected to an external charging device, the radio automatically enters the **High** mode.

GPS – Things to Keep in Mind

Where adequate signals from multiple satellites are not available, the GPS feature of your radio does not work. Such situations include but are not limited to:

- In underground locations
- Inside of buildings, trains, or other covered vehicles

- Under any other metal or concrete roof or structure
- Near a powerful radio or television tower
- When your GPS antenna is covered (for example, by your hand or other object) or facing the ground
- In temperature extremes outside the operating limits of your radio

Even where location information can be calculated in such situations, it may take longer to do so. Therefore, in any emergency situation, confirm your location with your dispatcher.

Furthermore, please note that even where adequate signals from multiple satellites are available, your GPS feature provides only an approximate location, often within 20–100 meters from your actual location.

Chapter 5

Main Menu

This chapter contains information on items in the main menu.

You can enter the menu items during a call. If you are viewing a menu when a new call starts, the radio exits the menu.



Important: Some menu items are model specific and may not be activated or available on your radio.

Scrolling through the Menu

Procedure:

- 1 From the home screen, press the **MENU** key.
- 2 Scroll to the required item by pressing **NAVIGATION** keys. Press the **SOFT** key assigned as **Select** or right **NAVIGATION** key to select.

If the menu item contains a further set of menu items, repeat step 2.

Menu Icons

The following icons make it easy to identify the menu items at first glance.

Table 14: Menu Icons















| Menu Icon | Description |
|---|--|
|  | Main Menu Items / Context Sensitive Menu It is assigned to MENU when the main menu items / context-sensitive menu are active. |
|  | Messages Send status messages, Send text messages (free text or according to user defined or predefined templates), Received messages in Inbox . |
|  | Contacts Add, search, edit, or erase entries in the contact list. |
|  | Security Lets you turn on/off and verify security features, and change passwords. |

Table continued...

| Menu Icon | Description |
|---|--|
|  | Setup Allows you to customize your radio. |
|  | More... Contains additional setup menu items. |
|  | Group Setup Contains additional menu items for Scanning Talkgroups features. |
|  | Favorites Contains shortcuts to frequently used talkgroups and contact numbers. |
|  | My Info Displays information about your radio and its numbers. |
|  | Recent Calls Contains a list of recent calls. |
|  | Networks Allows you to select a network. |
|  | Location Displays location of your radio. |
|  | Packet Data Allows you to send data from your radio to other devices. |
|  | Services Allows you to manage Broadcast, Assistance and Disaster Calls. |

Messages

This feature allows you to send and receive text messages. A message can contain up to 1000 characters, depending on your service provider settings.

Pressing the PTT button when a message is highlighted can cause one of the following actions, depending on your service provider settings:

- The radio ignores the PTT button request.
- The radio starts a Private Call with the message sender.
- The radio starts a Group Call on a currently selected talkgroup.

New Message

This menu item allows you to create a new message.

Sending Messages to Private/Phone

Procedure:

- 1 From the home screen, press the **MENU** key.
- 2 Select **Messages** → **New Message**.
- 3 Enter your message and press **Send**.
- 4 If needed, select **Private/Phone**.
- 5 Enter recipient number or press **abc** to choose it from your contacts.



Note:

For **Private** target selection, you can enter either Individual Short Subscriber Identity (ISSI) or Group Short Subscriber Identity (GSSI) of the recipient.

ISSI – a unique, individual ID assigned for each radio.

GSSI – in Dimetra called Group ID or Talkgroup ID.

- 6 Press **Send**, or **SEND** key, or the **PTT** button.

Sending Messages to Groups

Procedure:

- 1 From the home screen, press the **MENU** key.
- 2 Select **Messages** → **New Message**.
- 3 Type your message and press **Send**.
- 4 If needed, select **Group**.
- 5 Select a group to send the message.

Sending Store and Forward Messages

Prerequisites: Your service provider enables the Store and Forward feature.

Procedure:

- 1 From the home screen, press the **MENU** key.
- 2 Select **Messages** → **New Message**.
- 3 Press **MENU** key and select **Message Setup** → **On/Offline users**.
- 4 Enter your message and press **Send**.
- 5 If asked for the **Target selection**, select one of the following:
 - **Private** – enter the private number or press **abc** to choose the destination number from the contact list.
 - **Phone** – enter the phone number or press **abc** to choose the destination number from the contact list.



Note: Your service provider can enable to send a Store and Forward message to a talkgroup.

- 6 Select **Send**, or press **SEND** key or **PTT** button.

Delivery Report

Delivery Report is an acknowledgment that the radio can request upon sending a message to an individual recipient. You can define what type of Delivery Report your radio requests, or turn on/off this feature.

If the Delivery Report is received shortly after the message was sent, the radio:

- Displays a pop-up with one of the following messages:
 - **Message Sent** – if no Delivery Report is requested (and when a Store and Forward message has been received at the Store and Forward server)
 - **Message Delivered** – if the Delivery Report is requested and the message has been received by the target radio

- **Message Read**
 - if the **Consumed** Delivery Report is requested and the message is opened on the target radio
- **Message Failed** – if the Delivery Report is requested and the message has not been received by the target radio within a defined time period
- Saves the Delivery Report in **Outbox** along with a copy of the message.

If the Delivery Report is received after a longer period of time, the radio:

- Saves the Delivery Report in **Outbox** along with a copy of the message.
- If Delivery Report Notifications functionality is configured by your service provider, the radio also:
 - Temporarily saves a Delivery Report message in **Inbox**. The notification disappears after it is read.
 - Displays **New Message** icon.
 - Displays **New Delivery Status** notification screen (if possible).

Viewing Delivery Reports

Procedure:

- 1 From the home screen, press the **MENU** key.
- 2 Select **Messages** → **Inbox**.
- 3 Find a required message and select **Read**.
- 4 Press **MENU** key.
- 5 Select **Delivery Status**.

Configuring Delivery Reports

Prerequisites: Your service provider enabled the delivery report configuration.

Procedure:

- 1 From the home screen, press the **MENU** key.
- 2 Select **Messages** → **New Message**.
- 3 Press **MENU** key and select **Delivery Report**.
- 4 Select one of the following:
 - **None** — the radio does not request any delivery report.
 - **Received** — the radio requests reports on your messages that were received.
 - **Consumed** — the radio requests reports on your messages that were read.
 - **Both** — the radio requests reports on your messages that were received and read.

Inbox

It contains up to 100 new or old incoming messages.

Table 15: Inbox Icons





| Icon | Description |
|---|---|
|  | Unread (New) Message |
|  | Read (Old) Message |
|  | Sender Information in Message View — name or number |

Table continued...

| Icon | Description |
|---|---|
|  | Time and Date Stamp in Message View — arrival time and date |
|  | Delivery Status Received — delivery status for Store & Forward messages |

Messages sub-menu indicates the number of the messages. If the indication is for example 2/4, it means that two unread and four read messages are in the **Inbox**.

Entering the Inbox

Procedure:

- 1 From the home screen, press the **MENU** key.
- 2 Select **Messages** → **Inbox**.



Note: The status (if any) of the list is displayed for a few seconds:

- **No New or Old Messages** — The screen returns to the previous display within a few seconds.
- **Inbox Full** — Select **Ok**.

Receiving New Messages

Procedure:

- 1 New message received.
Your radio displays an animation and plays a *New Mail Received* tone.
- 2 Select one of the following:
 - **Read** — opens the entire message.
 - **Back** — dismisses the message. You can access the message later from the **Inbox**.

Using Submenus in the Inbox and the Outbox

Procedure:

- 1 From the home screen, press the **MENU** key.
- 2 Select **Messages** → **Inbox** or **Outbox**.
- 3 Highlight the required message and press **MENU** key.
- 4 Select one of the following:
 - **Store** — Saves a message as a template. Change the default template name and press **Ok**.
 - **Delete** — Deletes the selected message. Press **Yes** to confirm.
 - **Delete All** — Deletes all the messages in the **Inbox/Outbox**. Press **Yes** to confirm.
 - **Reply** (only for **Inbox**) — Invokes the edit screen with the old message as default text and the message originator as a recipient. After editing, press **Send**, the **PTT** button, or the **SEND** key to send.
 - **Resend** (only for **Outbox**) — Invokes the edit screen with previously entered text with the same recipient. After editing, press **Send**, the **PTT** button, or the **SEND** key to send.
 - **Forward** — Invokes the edit screen with the old message to send it to a different participant. After editing, press **Send**, the **PTT** button, or **SEND** key to send.
 - **Refresh** — Re-orders the message list and displays the new messages.
 - **Delivery Status** (only for **Outbox**) — Shows the date and time of the message when it sent, delivered, read, and expired was not delivered, expired was not read, failed unknown.

Embedded Number

This feature allows you to call a number from a message or to start a group call with the message sender talkgroup.

Storing Numbers from Messages

Prerequisites: Embedded Number feature is enabled by your service provider.

When and where to use: You can save the sender's or embedded number from the message to a new or existing contact.

Procedure:

- 1 From the home screen, press the **MENU** key.
- 2 Select **Messages** → **Inbox**.
- 3 Highlight the required message and select **Read**.
- 4 Press the PTT button.
- 5 Radio displays a list of the numbers (including the senders number).
- 6 Highlight the required number and press **Store**.
- 7 Highlight required contact and press **View**.



Note: To store a number for a new contact, select **[New Contact]** and fill out the required fields. Press **Done** to save it..

- 8 Select **Edit**.
- 9 Choose the **Type** of the new number and press **Done**.

Calling Numbers in Messages

Prerequisites: Embedded Number feature is enabled by your service provider.

When and where to use: You can return a voice call to the sender of a message or to any number that is embedded in the message text.

Procedure:

- 1 From the home screen, press the **MENU** key.
- 2 Select **Messages** → **Inbox**.
- 3 Highlight the required message and select **Read**.
- 4 Press the PTT button.
- 5 Radio displays a list of the numbers (including the senders number).
- 6 To call, highlight to the required number and press the PTT button or the **SEND** key.
- 7 Select **Ctype** to choose the type of call (**Private**, **Phone**, or **PABX**).
- 8 Press the PTT button or the **SEND** key.

Making Group Calls on theTalkgroup of the Message Sender

Prerequisites: Embedded Number feature is enabled by your service provider.

Procedure:

- 1 From the home screen, press the **MENU** key.
- 2 Select **Messages** → **Inbox**.
- 3 Highlight the required message and press the PTT button.

Immediate Message

When the new immediate message is received, radio plays the *New Mail Received* tone and displays the content overlapping your previous screen. All immediate messages are stored in the **Inbox**. If the radio is in PIN Lock state, immediate message is displayed after correct PIN is entered.



Note: This is a selling feature.

Outbox

Outbox stores all sent messages.

Table 16: Outbox Icons

| Icon | Description |
|------|-----------------------------|
| | Delivery in Progress |
| | Delivery Accomplished |
| | Delivery Failed |
| | Successful Outgoing Message |
| | Failed Outgoing Message |

CO Box

CO Box contains incoming and outgoing Call-Out messages arranged chronologically with the newest at the top of the list. Clicking **Select** on a Call-Out message headline displays more detailed information on the item.

When the radio is in normal mode, you are able to browse through all messages in the **CO Box**. However, if the radio is in the Call-Out mode, you can only browse through the information regarding the currently ongoing Call-Out message.

Related Links

[Call-Out](#) on page 97

Templates

This feature is used to store up to 100 predefined and your message templates. Each of the **Inbox** and **Outbox** message can be stored as a template. Each template name and text can be edited afterwards.

Sending User-Defined Templates

Procedure:

- 1 From the home screen, press the **MENU** key.
- 2 Select **Messages** → **Templates**.
- 3 Highlight the required template name and press **Send**.
- 4 Do one of the following:
 - Enter the number or press **abc** to select the name from your contact list. Press **Send**.
 - Select required talkgroup from the **TalkGroup List**.

Setting User-Defined Templates

Procedure:

- 1 From the home screen, press the **MENU** key.
- 2 Select **Messages** → **Templates**.
- 3 Highlight the required template and press **MENU**.
- 4 Select one of the following:
 - **View** — Displays template text.
 - **Delete** — Deletes the template.
 - **Edit Text** — Opens edit screen with the template text. Edit the text and press **MENU**. Select **Save Changes** to save edited template, or **Store** to save the edited template as a new one.
 - **Edit Name** — Opens edit screen with the template name. Press **Ok** to save the template.

Predefined Templates

Predefined message templates are programmed into your radio. You are allowed to perform limited edit operations of the predefined template. You can send it, but you are not able to store the edited template or erase it from the predefined template list.

Viewing Predefined Templates

Procedure:

- 1 From the home screen, press the **MENU** key.
- 2 Select **Messages** → **Predefined**.
- 3 Highlight the required template and press **MENU** key.
- 4 Select **View**.

Sending Predefined Templates

Procedure:

- 1 From the home screen, press the **MENU** key.
- 2 Select **Messages** → **Predefined**.
- 3 Highlight the required template and press **Send**, the **PTT** button, or the **SEND** key.



Note: You can edit the predefined template before you send it. Press the **MENU** key and select **Edit**. Edit screen opens with the template text. You are only allowed to replace the existing text.

Status Messages

The radio allows you to send two types of status messages: statuses and targeted statuses. Your service provider determines which type is enabled on the radio.

Statuses can be sent either to a selected talkgroup or to a private number programmed by your service provider. Targeted statuses can be sent to any talkgroup defined for the radio or to any private number (from the contact list or entered manually).

Viewing a Status Message Number

Procedure:

- 1 From the home screen, press the **MENU** key.
- 2 Select **Messages** → **Send Status**.
- 3 Press the **MENU** key and select **View**.

Sending Status Messages

This procedure allows you to send status messages to either a selected talkgroup or a programmed private number. Only one option can be enabled at a time.

Prerequisites:

- If sending statuses to talkgroups is enabled: switch to the talkgroup to which you want to send a status message.
- If sending statuses to private numbers is enabled: no action is needed, the private number is set up by your service provider

Procedure:

- 1 From the home screen, press the **MENU** key.
- 2 Select **Messages** → **Send Status**.
- 3 Highlight the required status message and press **Select**, the PTT button, or the **SEND** key.

Targeted Status Messages

This feature enables sending status messages to user selectable addresses. By default, targeted status messages can be sent to private or talkgroup addresses. Your service provider may restrict valid addresses to numbers stored in **Contacts**.

Sending Targeted Status Messages

Procedure:

- 1 From the home screen, press the **MENU** key.
- 2 Select **Messages** → **Send Status**.
- 3 Highlight the required status message and press **Select**, the PTT button, or the **SEND** key.
- 4 Do one of the following:
 - Enter the number or press **abc** to select the name from your contact list. Press **Send**.
 - Select required talkgroup from the **TalkGroup List**.

The display shows one of the following delivery reports:

- **Status Sent.**
- **Status Failed.**

Contacts

This sub-menu stores all your contact numbers. Each entry requires the following information:

- **Name** — if you store more than one number to one contact, this entry is required.
- **Type** — each contact must be assigned to one of the following types:

Table 17: Contact Types







| Contact Icon | Description |
|---|--|
|  | Private Cannot have a speed dial number. |
|  | Mobile |

Table continued...

| Contact Icon | Description |
|---|---|
|  | Home |
|  | Work |
|  | PABX |
|  | Other |
| ◀ ▶ | Pickers |
| | Indicate more than one number in a contact. |

- # (number) — each contacts entry must contain a number.
- **Speed #** — accept the default Speed Dial number or change it.

Creating Contacts

Procedure:

- 1 From the home screen, select **Contcs**.
- 2 Select [**New Contact**].
- 3 Highlight **Name** and press **Change**. Enter the name of your contact and press **Ok**.
- 4 Highlight **Type** and press **Change**. Select the required type of your contact.



Note: You can use the left and right **NAVIGATION** keys to select the type of your contact from the **Contact Details** screen.

- 5 Highlight # (number) and press **Change**. Enter the number of your contact and press **Ok**.
- 6 If needed, highlight **Speed #** and press **Change**. Enter the speed dial number (1– 1000) of your contact and press **Ok**.



Note: If the entered number exist, the radio displays **Overwrite?** message. Press **Yes** to confirm, or **No** to enter the speed dial number again.

- 7 Press **Done**.

You have create a contact with one number. To add additional number repeat steps 4–6.

Editing Contacts

Procedure:

- 1 From the home screen, press **Contcs**.
- 2 Highlight the contact you want to edit.
- 3 Press the **MENU** key.
- 4 Press **Edit**.
- 5 Highlight one of the following entries and press **Change** to edit:
 - **Name**
 - **Type**
 - # (number)
 - **Speed #**
- 6 Press **Done**.

Deleting Numbers

Procedure:

- 1 From the home screen, press **Contcs**.
- 2 Select a contact you want to edit.
- 3 Use left or right NAVIGATION keys to choose the required number.
- 4 Press MENU.
- 5 Select **Delete number**.



Note: If an entry contains only one number, deleting the number deletes the entry.

- 6 Press **Yes**.

Deleting Contacts

Procedure:

- 1 From the home screen, select **Contcs**.
- 2 Highlight a contact you want to delete.
- 3 Press the MENU key.
- 4 Select **Delete contact**.
- 5 Select **Yes**.

Checking Capacity

When and where to use: To see how many numbers are stored in the radio.

Procedure:

- 1 From the home screen, select **Contcs**.
- 2 Press the MENU key.
- 3 Select **Capacity**.
- 4 Select one of the following:
 - **Private**
 - **Phone / PABX**
 - **Contact**

Dialing through the Contact List

Procedure:

- 1 From the home screen, press **Contcs**.
- 2 To highlight the required contact, use up and down NAVIGATION keys, or enter up to 12 characters of the contact name.
- 3 If the contact has more than one number, use left and right NAVIGATION keys to select the required number.
- 4 Press the PTT button to initiate a simplex call with a **Private** number. Otherwise use the SEND key to initiate a duplex call.

Security

This sub-menu stores all your security settings.

PIN Protect

This feature allows you to enable PIN code authentication at the next power on. This code protects your radio against unauthorized use.

If you are unable to unlock the radio, you can only send or receive Emergency Calls and adjust the volume level with the VOLUME KNOB.

Related Links

[Unlocking Your Radio](#) on page 28

[Changing PIN Codes](#) on page 68

Protecting the Radio with a PIN Code

Procedure:

- 1 From the home screen, press MENU → **Security** → **PIN Protect**.
- 2 Select **On**.
- 3 Enter 4-digit PIN code. By default it is 0000 (four zeros).



Suggestion: To increase security, set your own PIN code.

Post requisites: Each time you turn on the terminal, PIN code is required.

Unblocking Your Radio

Prerequisites: You blocked your radio by entering incorrect PIN code for three times (by default).

Procedure:

- 1 Radio displays **Unit Blocked** Enter **PUK**.
- 2 Enter 8-digit PUK (Personal Unblocking Key) number.



Note: The PUK is an eight-digit master code provided by your service provider.

- 3 Enter the new PIN code twice.

Changing PIN Codes

Procedure:

- 1 From the home screen, press the MENU key.
- 2 Select **Security** → **Change Code**.
- 3 Radio prompts for the **Old Code**. Enter currently used 4-digit security code (default setting is 0000).
- 4 If the entered code matches the old code, radio prompts for the new code twice.

Your radio displays **Code Accepted**.

Related Links

[Unlocking Your Radio](#) on page 28

[PIN Protect](#) on page 68

Keylock Setup

The keypad lock feature allows locking the keypad to prevent pressing a key accidentally. The keypad lock/unlock can be invoked by using an appropriate option from the radio menu. By default press MENU, and then left NAVIGATION key.

Your service provider can determine which of the following elements are additionally inoperative while the keypad is locked:

- The PTT button
- Side buttons
- The ROTARY KNOB
- The ON/OFF/END/HOME key

The EMERGENCY button is always operative.

Related Links

[Locking/Unlocking the Keys/Buttons](#) on page 29

Keypad Lock Notification

When the keypad is locked, your service provider can configure one of the following instructions:

- None — no notification is displayed.
- Notification Only — **Keys Locked** is displayed.
- Notification and Instruction — **Press Menu + Left to lock/unlock keypad** is displayed.

Setting Automatic Keylock Delay

Procedure:

- 1 From the home screen, press the MENU key.
- 2 Select **Security** → **Keylock Setup** → **Delay**.
- 3 Use up and down NAVIGATION keys to change the minutes and press **Done**.

Setting Keylock on Startup



Procedure:

- 1 From the home screen, press the MENU key.
- 2 Select **Security** → **Keylock Setup** → **Start Locked**.
- 3 Select **On/Off**.

Air Encryption

Air Encryption is a feature that enables encryption of entire communication between the radio and infrastructure, which results in increased security of calls, messages, and data.

If configured by your service provider, the radio plays a sound and displays **Call & Data Not Encrypted** when encryption is on and you receive a clear call (unencrypted). This feature provides service confidentiality between you and the system.

In the TMO Mode, when Air Encryption is enabled on you radio but cannot be supported due to an infrastructure failure, the following icon appears on the display: . When encryption is not available in the DMO Mode, the radio displays: .

This menu item allows you only to view air encryption state.



Note: This is a selling feature.

Related Links

[Status Icons](#) on page 25

Viewing the Air Encryption State

Procedure:

- 1 From the home screen, press the MENU key.
- 2 Select **Security** → **AirEncrypt**.
- 3 Your radio displays:
 - a **Air Encryption Is Off**.
 - b **Air Encryption Is On**.

Air Encryption Key Deletion

Please check with your service provider whether the radio is provided with Air interface encryption keys. You can delete the Air interface encryption keys from the radio by entering the following sequence: **00##.



Note:

- It takes a minute for this feature to delete all the encryption keys from the radio. During this time, do not remove the battery.
- Deletion is performed in idle TMO/DMO or Emergency Operation.



Caution: Using this feature will disable the radio, and your service provider will need to re-enable the radio.

K Validity

K (Key) is a secret key the infrastructure uses to authenticate the radio in the system. It is part of the authentication that provides service confidentiality between your radio and the system.

Verifying K Validity

Procedure:

- 1 From the home screen, press the MENU key.
- 2 Select **Security** → **K Validity**.
- 3 Your radio displays:
 - **K is Valid** — the infrastructure can authenticate your radio.
 - **K is Invalid** — the infrastructure is unable to authenticate your radio. Please call your service provider to restore the key to your radio.

SCK (Air Interface Encryption Class 2)

SCK (Static Cipher Key) is a secret key used for the Air Interface Encryption Class 2. It may be used to encrypt calls and data in TMO and DMO. The SCK air interface encryption provides service confidentiality between radios and infrastructure when in TMO, and between radios when in DMO. A radio is capable of being loaded with up to 32 SCKs. Specific keys are used for encrypting the air interface.

Any mismatch between radios and/or infrastructure impacts communication – only those using the same key as the transmitting party are able to decode and hear the communication.

TMO SCK

Use of SCKs in TMO needs to be enabled by your service provider. The SCKs used in TMO are called TMSCKs.

DMO SCK

Use of SCKs in DMO needs to be enabled by your service provider. The SCKs used in DMO are called DMSCKs.

Changing DMO SCK

Procedure:

- 1 From the home screen, press the **MENU** key.
- 2 Select **Security** → **DMO SCK**.
- 3 Press **Next**.
- 4 Radio displays **Change to version** .
- 5 Select one of the following:
 - **Yes** — to change the key. Your radio displays **Key version changed**.
 - **No** — to leave the key. Your radio displays **Code Not Changed**.

Verifying TMSCK Validity

When and where to use: To ensure that the TMSCKs in the radio are valid and can be used for the air interface encryption.

Procedure:

- 1 From the home screen, press the **MENU** key.
- 2 Select **Security** → **TMSCK Validity**.
- 3 The radio displays:
 - **TMSCK is Valid** – the radio can work encrypted in TMO.
 - **TMSCK is Invalid** – the radio cannot work encrypted in TMO. Please contact your service provider to restore SCKs to your radio.

Verifying DMSCK Validity

When and where to use: To ensure that the DMSCKs in the radio are valid and can be used for the air interface encryption.

Procedure:

- 1 From the home screen, press the **MENU** key.
- 2 Select **Security** → **DMSCK Validity**.
- 3 The radio displays:
 - **DMSCK is Valid** – the radio can work encrypted in DMO.
 - **DMSCK is Invalid** – the radio cannot work encrypted in DMO. Please contact your service provider to restore SCKs to your radio.

Covert Mode

This feature enables you to completely shut down all visible and audible alerts and notifications making the radio unnoticeable even in a silent and dark environment.

When your radio is in the Covert Mode, you cannot enter the following menu items of the **Setup** menu.

- **Vibrate**.
- **Set Volume**
- **Tones**
- **Backlight** (in **Display** menu item)

When the Covert Mode is turned on:

- All tones are set to **Off** (corresponding to **All Tones** menu entry).
- Group audio is set to **Spkr Cntrl** (corresponding to **Audio Toggle** menu entry).
- The private speaker is set to **Off** (this setting causes all the calls are routed through the earpiece).

- Backlight is set to **Disabled** (corresponding to **Backlight** menu entry).
- The LED indicator is switched off.

The radio powers up in the mode set before turning off. Thus if the Covert Mode was set before turning off, the radio turns on in the Covert Mode .

When the Covert Mode is turned off, all the changed settings are reverted to the previous state.

This feature can be used as the One-Touch Button.

Activating the Covert Mode

Procedure:

- 1 From the home screen, press the `MENU` key.
- 2 Select **Security** → **Covert Mode**.
- 3 Select one of the following:
 - **On** — all tones are set to off, and the backlight and the LED are disabled immediately. The group audio is routed to the earpiece. The radio displays **Covert Mode On**.
 - **Off** — all settings for tones, backlight and audio are restored. The radio displays **Covert Mode Off**.

Setting to Vibrate in the Covert Mode

Procedure:

- 1 From the home screen, press the `MENU` key.
- 2 Select **Security** → **Covert Mode** → **Vibrate**.
- 3 Select one of the following:
 - **On** — To restore all vibrations.
 - **Off** — To disable all vibrations.

SDS Remote Control

SDS Remote Control is a feature that enables to remotely control behavior and configuration of the radio via special SDS messages. The messages can be sent both in TMO and DMO (including the Repeater Mode) by any radio capable of controlling other radios. During the execution of the Remote Control messages, depending on your service provider settings, the radio can play a tone, vibrate, or display an appropriate icon in the status icon area.



Note: This is a selling feature.

Setting SDS Remote Control

When and where to use: To enable/disable support of special SDS messages that allow remote control of the radio.

Procedure:

- 1 From the home screen, press the `MENU` key.
- 2 Select **Security** → **Remote Control**.
- 3 Select **On** to enable, or **Off** to disable remote control.

Setup

This sub-menu allows you to change your radio configuration.

Vibrate

This sub-menu allows you to determine if your radio vibrates, or rings, or both vibrates and rings when receiving a call.

Setting Default Vibrate

Procedure:

- 1 From the home screen, press the **MENU** key.
- 2 Select **Setup** → **Vibrate**.
- 3 Select one of the following:
 - **Vibe then Ring**
 - **Vibe Only**
 - **Ring Only**

Setting Detail Vibrate

Procedure:

- 1 From the home screen, press the **MENU** key.
- 2 Select **Setup** → **Vibrate** → **Details...**
- 3 Select one of the following:
 - **Duplex Calls** — Sets the vibrate settings for Phone, PABX, and Duplex Private calls.
 - **Simplex Calls** — Sets the vibrate settings for Simplex Private Calls.
 - **Group Call** — Sets the vibrate settings for Group Calls.
 - **Messages** — Sets the vibrate settings for status messages and text messages.
- 4 Select the required setting, and press **Select**.



Note: If you choose **Duplex Calls**, **Simplex Calls** or **Messages**, the settings available are **Vibe then Ring** (for messages it is **Vibe & Ring**), **Vibe Only** or **Ring Only**. If you choose **Group Call**, the settings available are **Vibe On** or **Vibe Off** only.

Ring Style

This sub-menu allows you to set the incoming call ring style.

Setting Ring Style

Procedure:

- 1 From the home screen, press the **MENU** key.
- 2 Select **Setup** → **Ring Style**.
- 3 Select one of the following:
 - **Duplex** — To set the new ring style to all duplex calls.
 - **Simplex** — To set the new ring style to all simplex calls.



Note: Upon entry into this sub-menu, the display shows the current ring style used.

- 4 Scroll to the desired style and press **Select**.



Note: New ring style is played immediately for a few seconds. If necessary, adjust the volume level.

Set Volume

This menu item allows you to adjust the **Simplex**, **Duplex**, **Earpiece**, **Speaker**, and **Keypad** tone volume.

Related Links

[Volume Adjustment Mode](#) on page 76

Setting Volume

Procedure:

- 1 From the home screen, press the **MENU** key.
- 2 Select **Setup** → **Set Volume**.
- 3 Select one of the following:
 - **Duplex Vol** — sets the volume level for duplex ringtones.
 - **Simplex Vol** — sets the volume level for simplex ringtones.
 - **Earpiece Vol** — sets the volume level for the earpiece.
 - **Speaker Vol** — sets the volume level for the speaker.
 - **Keypad Vol** — sets the volume level for keypad tones.



Note: If the display shows only one option **Volume**, you can adjust all of the above settings at once. You have the option to change the settings individually when the **Volume Adj. Mode** is set to **Individual**.

- 4 Press right or left **NAVIGATION** key to change the value.



Note: When the battery level is low it is not recommended to attach the 4 Ohm speaker to the radio as it can cause reset or shutdown of the radio.

Related Links

[Setting Volume Adjustment Mode](#) on page 76

Language

This sub-menu allows you to change the language of the radio.

Setting Language

Procedure:

- 1 From the home screen, press the **MENU** key.
- 2 Select **Setup** → **Language**.
- 3 Select desired language.

Data Setup

This menu item allows you to set up your radio to transmit and receive data from the external device.

To connect your radio accessory connector to the external device, use the PMKN4025 cable. The external device must run an application complying with the TETRA standards.



Note:

- Data services are available only in TMO Mode.
- Data services are blocked in TXI Mode.
- When set to **Voice Only**, the built in data modem is disabled to conserve battery power.

Setting Data Function

Procedure:

- 1 From the home screen, press the MENU key.
- 2 Select **Setup** → **Data Setup**.
- 3 Select one of the following:
 - **Voice Only** — Your radio receives and transmits voice calls only.
 - **Data Only** — Your radio acts as a modem. It rejects incoming and outgoing voice calls (except for Emergency Calls), status and text messages.
 - **Voice & Data** — Your radio acts as a modem but voice calls have priority over data calls and can interrupt them.

Audio

This menu item allows you to adjust your radio audio settings.

Audio Profiles

An audio profile is a set of audio parameters, such as the volume of alert tones, that are configured by your service provider to fit a particular operating environment. For example, the audio parameters can be adjusted to situations when the radio operates inside a building or on a noisy street.

If programmed, the radio displays a name of a currently used audio profile (on the home screen) and/or an appropriate icon associated with the profile (in the status icon area).

Your service provider can configure a maximum of five audio profiles.

For a detailed description of a specific audio profile, contact your service provider.

Setting Audio Profiles

When and where to use: To adjust the audio parameters of the radio its current operating environment.

Procedure:

- 1 From the home screen, press the MENU key.
- 2 Select **Setup** → **Audio** → **Audio Profile**.
- 3 Select a required profile.

Howling Suppression

The howling suppression is a mode increasing the stability of the acoustic feedback loop. The radio eliminates howling caused by the feedback loop from the receiving radios to the sending radio in simplex calls. You can toggle the howling suppression during an active call.

To enable this anti-howling function, you can either use the radio menu or the corresponding One-Touch Button.

Setting Howling Suppression

Procedure:

- 1 From the home screen, press the MENU key.
- 2 Select **Setup** → **Audio** → **Howling Suppr..**
- 3 Select required setting.



Note: Your service provider can set up the state of the howling suppression on powering up the radio. Depending on the settings, the radio can either disable the howling suppression or set the last remembered state.

Audio Toggle

You can control audio routing (speaker/earpiece) for any private or group call through the dedicated **SPEAKER CONTROL** key. You can also define through the menu to have all group calls in high audio or controlled by the **SPEAKER CONTROL** key.

Setting Audio Toggle

Procedure:

- 1 From the home screen, press the **MENU** key.
- 2 Select **Setup** → **Audio** → **Audio Toggle**.
- 3 Select one of the following:
 - a **Always Loud** — The audio sound comes from the speaker (high audio only). **SPEAKER CONTROL** key is disabled.
 - b **Spkr Cntrl** — The audio goes through the earpiece or the speaker. You can switch between low and high audio by pressing **SPEAKER CONTROL** key.

Volume Adjustment Mode

You can set the volume to **Individual** or **Common**. When it is set to **Individual**, the volume level for **Voice**, **Duplex**, **Simplex**, **Earpiece**, **Speaker** and **Keypad** can be set per user preferences. When set to **Common**, the audio has one setting for all items.

Related Links

[Set Volume](#) on page 74

Setting Volume Adjustment Mode

Procedure:

- 1 From the home screen, press the **MENU** key.
- 2 Select **Setup** → **Audio** → **Volume Adj. Mode**.
- 3 Select one of the following:
 - **Individual** — You can set **Duplex**, **Simplex**, **Earpiece**, **Speaker** and **Keypad** per your preferences in **MENU** → **Setup** → **Set Volume**.
 - **Common** — You can set one value for all the items in **MENU** → **Setup** → **Set Volume**.

Related Links

[Setting Volume](#) on page 74

Tones

This field sets the volume level for the tones set.

Keypad Tone

You can activate/deactivate keypad tone at every key press.

Setting Keypad Tone

Procedure:

- 1 From the home screen, press the **MENU** key.
- 2 Select **Setup** → **Tones** → **Keypad Tone**.
- 3 Select one of the following:
 - **On** — Activates keypad tone.

- **Off** — Deactivate keypad tone.

All Tones

You can activate/deactivate all tones.

Setting All Tones

Procedure:

- 1 From the home screen, press the **MENU** key.
- 2 Select **Setup** → **Tones** → **All Tones**.
- 3 Select one of the following:
 - a **On** — Activates all the tones.
 - b **Off** — Deactivates all the tones.

Talk Permit

You can set a different tone upon pressing the PTT button.

Setting Talk Permit

Procedure:

- 1 From the home screen, press the **MENU** key.
- 2 Select **Setup** → **Tones** → **Talk Permit**.
- 3 Select one of the following:
 - **No Tone** — No tone heard upon pressing the PTT button.
 - **Short Tone** — Short tone heard upon pressing the PTT button.
 - **Normal Tone** — Factory-default tone heard upon pressing the PTT button.

Clear to Send

You can activate/deactivate tone for the transmitting radio that the receiving radio is ready to accept the transmission.

Setting Clear to Send

Procedure:

- 1 From the home screen, press the **MENU** key.
- 2 Select **Setup** → **Tones** → **Clear to send**.
- 3 Select one of the following:
 - **Tone On** — Activate clear to send tone.
 - **Tone Off** — Deactivates clear to send tone.

Periodic Alert

You can activate/deactivate periodic tone indication for the missed calls, the unread messages, and low battery level. For each notification, your radio generates an unread message tone with the amber LED color indication.

Setting Periodic Alert

Procedure:

- 1 From the home screen, press the **MENU** key.
- 2 Select **Setup** → **Tones** → **Periodic Alert**.

- 3 Select one of the following:
 - **Alert** — Activates/deactivates periodic tone.
 - **Period** — Indicates the time between each periodic tone.

D-PTT Tones

This menu item contains the settings for the Double PTT feature.

The Double PTT feature allows you to send a tone pattern (single, double, or triple) when the radio is in idle or the Group Call mode by pressing the PTT button twice.

After the D-PTT tone is played, the user can press and hold the PTT button once again to get the permission to talk. Otherwise, if the user presses the PTT button while the D-PTT tone is played, it is ignored.

After the D-PTT tone is sent keeping the PTT button pressed, it results in permission to talk. The D-PTT tone is not audible on a sending radio.



Note: This feature needs to be enabled by your service provider.

Setting D-PTT Tones

Procedure:

- 1 From the home screen, press the **MENU** key.
- 2 Select **Setup** → **Tones** → **D-PTT Tones**.
- 3 Select one of the following:
 - **D-PTT Mode** — Activates/deactivates D-PTT tone.
 - **Tone Style**— Indicates how many times the D-PTT tone is played.

Display

This menu item allows you to adjust your radio display settings.

Related Links

[Display](#) on page 23

[Display](#) on page 23

[Setting Time and Date on the Display](#) on page 81

Setting Flip Display

When and where to use:

The feature is useful for a user who has to wear the radio on a shoulder, belt, or lapel and at the same time wishes to read the display upside down.

Procedure:

- 1 From the home screen, press the **MENU** key.
- 2 Select **Setup** → **Display** → **Flip Display**.
- 3 Select one of the following:
 - **On** – to activate this feature.
 - **Off** – to deactivate this feature.

Setting Font Level

When and where to use: To increase/decrease text size so you can adjust the interface readability to existing conditions.

Procedure:

- 1 From the home screen, press the MENU key.
- 2 Select **Setup** → **Display** → **Font Level**.
- 3 Select one of the following:
 - 1 – small font size
 - 2 – medium font size
 - 3 – large font size



Note: In some languages number of available font levels can be limited.

Setting Large Idle Font

When and where to use: To enable/disable large font on the home screen.

Procedure:

- 1 From the home screen, press the MENU key.
- 2 Select **Setup** → **Display** → **Large Idle Font**.
- 3 Select **On** to enable, or **Off** to disable displaying large font on the home screen.



Note: Large Idle Font is not available in some languages.

Setting Extra Zoom

Enabling Extra Zoom simultaneously changes three settings: switches **Font Level** to the largest possible one, activates **Large Idle Font**, and sets **Extended Status Icons** to **Idle Only**

If you modify any of these settings, for example decrease the font level, the radio leaves the Extra Zoom Mode. However, to restore all the three previous settings, you need to manually change the values of **Font Level**, **Large Idle Font**, and **Extended Status Icons**. If you cannot restore a setting, contact your service provider.

Procedure:

- 1 From the home screen, press the MENU key.
- 2 Select **Setup** → **Display** → **Extra Zoom**.
- 3 Select **On** to enable or **Off** to disable extra zoom.



Note: **Extra Zoom** is not available on radios using the SIM card encryption.

Setting Extended Status Icons

Procedure:

- 1 From the home screen, press the MENU key.
- 2 Select **Setup** → **Display** → **Extended Status Icons**.
- 3 Select one of the following:
 - **Disabled** – the radio always displays icons in normal size.
 - **Idle Only** – the radio displays enlarged icons only on the home screen.

- **Always** – the radio displays enlarged icons both on the home screen and when browsing through the radio menu.

Setting Screen Saver

Procedure:

- 1 From the home screen, press the **MENU** key.
- 2 Select **Setup** → **Display** → **Screen Saver** → **Activate**.
- 3 Select one of the following:
 - **Auto** — Makes the screen saver activate automatically after an amount of time.
 - **Disabled** — Disables the screen saver.

Setting Backlight

When and where to use: To save the battery power.

Procedure:

- 1 From the home screen, press the **MENU** key.
- 2 Select **Setup** → **Display** → **Backlight**.
- 3 Select one of the following:
 - **Auto** – backlight is triggered by turning on the radio, by pressing any key on the device or on the accessory that is connected to it. Also charging or getting signal from the services like: Call-Out message, DGNA and TX timeout during priority call are going to turn on the backlight.
 - **Semi Auto** – backlight is turning on when you are switching on the radio, pressing assigned button to the backlight feature, or charging.
 - **Disabled** – backlight is disabled and the display is always dimmed.

Setting Wallpaper

When and where to use: To change the look of the home screen.

Procedure:

- 1 From the home screen, press the **MENU** key.
- 2 Select **Setup** → **Display** → **Wallpaper**.
- 3 Select one of the following:
 - **On** — To activate this feature.
 - **Off** — To deactivate this feature.

Setting Contrast

When and where to use: This feature sets the contrast of the display to enhanced visibility of the interface.

Procedure:

- 1 From the home screen, press the **MENU** key.
- 2 Select **Setup** → **Display** → **Contrast**.
- 3 Use left and right **NAVIGATION** key to change the value.
- 4 Press **Ok**.

Time and Date

This sub-menu controls the displayed time and date on the home screen.



Note: If the Home Display Text Message feature is enabled, Home Mode Display Text may cover time and date, depending on the Configurable Idle Screen settings.



Note: Infrastructure synchronizes the time and date. When not within the infrastructure signal range you can set the values manually.

Setting Time and Date on the Display

Procedure:

- 1 From the home screen, press the **MENU** key.
- 2 Select **Setup** → **Time & Date** → **Display**.
- 3 Select one of the following:
 - **Time & Date** — Your radio displays time and date.
 - **Time Only** — Your radio displays time only. **Format Date** sub-menu is disabled.
 - **Date Only** — Your radio displays date only. **Format Time** sub-menu is disabled.
 - **Off** — Your radio does not display time nor date. **Format** menu is disabled.

Related Links

[Display](#) on page 23

[Display](#) on page 78

Setting the Time Format

Prerequisites: If **MENU** → **Setup** → **Time & Date** → **Display** is set to **Time & Date** or **Time Only**.

Procedure:

- 1 From the home screen, press the **MENU** key.
- 2 Select **Setup** → **Time & Date** → **Format** → **Format Time**.
- 3 Select one of the following:
 - **12-Hour** — Displays the time with **am** (before noon) or **pm** (after noon) indication.
 - **24-Hour**.

Setting the Time Manually

When and where to use: If the time cannot update automatically through the infrastructure.

Procedure:

- 1 From the home screen, press the **MENU** key.
- 2 Select **Setup** → **Time & Date** → **Set** → **Set Time**.
- 3 Enter current time using **NAVIGATION** keys.
- 4 Press **Done**.

Setting the Date Format

Prerequisites: If **MENU** → **Setup** → **Time & Date** → **Display** is set to **Time & Date** or **Date Only**.

Procedure:

- 1 From the home screen, press the **MENU** key.
- 2 Select **Setup** → **Time & Date** → **Format** → **Format Date**.
- 3 Select (D — day, M — month, Y — year):
 - **DD/MM/YY**
 - **MM/DD/YY**

- DD-MON-YY
- YY/MM/DD

Setting the Date Manually

When and where to use: If the time cannot update automatically through the infrastructure.

Procedure:

- 1 From the home screen, press the **MENU** key.
- 2 Select **Setup** → **Time & Date** → **Set** → **Set Date**.
- 3 Enter current time using **NAVIGATION** keys.
- 4 Press **Done**.

Setting Time Offset

Procedure:

- 1 From the home screen, press the **MENU** key.
- 2 Select **Setup** → **Time & Date** → **Set** → **Time Offset**.
- 3 Enter time offset using **NAVIGATION** keys.



Note: You can adjust the offset value, with 15 minute steps, up to 14 hours ahead or behind.

- 4 Press **Done**.

Setting Automatic Updates for the Time and Date

Procedure:

- 1 From the home screen, press the **MENU** key.
- 2 Select **Setup** → **Time & Date** → **System Update**.
- 3 Select one of the following:
 - **Off** — All the infrastructure informations are ignored. The radio uses internal time and offset.
 - **Time Only** — Time displayed is calculated from the offset programmed by your service provider added or subtracted from the infrastructure time.
 - **Time & Offset** — Time and offset are updated after receiving from the infrastructure.

Energy Economy

Energy Economy (EE) is a mode of operation to save battery life. Your radio does not monitor all downlink time slots of the Main Control Channel. If the radio is in the charger, **Energy Economy** mode is not needed.

Enabling Energy Economy

Procedure:

- 1 From the home screen, press the **MENU** key.
- 2 Select **Setup** → **Energy Economy** → **EE Selection**.
- 3 Select one of the following:
 - **On** — Activates Energy Economy feature.
 - **Off** — Deactivates Energy Economy feature.

Viewing the Energy Economy Status

Procedure:

- 1 From the home screen, press the **MENU** key.
- 2 Select **Setup** → **Energy Economy** → **EE Status**.
- 3 The Energy Economy status is displayed as:
 - **Energy Economy Is Supported By System**
 - **Energy Economy Is Currently Not Supported By System**

Rotary Knob

This menu item allows you to set all the related functionality of the **ROTARY KNOB**.

Setting Rotary Knob Mode

Procedure:

- 1 From the home screen, press the **MENU** key.
- 2 Select **Setup** → **Rotary Knob** → **Rotary Mode**.
- 3 Select one of the following:
 - **Dual** — Both modes are available. Turn the **ROTARY KNOB** to adjust the volume or press and then turn to switch to a different talkgroup.
 - **Volume** — The knob is used only as a volume control. Turn it clockwise to increase the audio volume level.
 - **Scroll** — The knob is used only to change the talkgroup, or in the menu to scroll menu items.



Note: If you choose **Scroll** and the display shows:

- **Scroll Selected** — To adjust volume level go to the main menu, select **Setup** → **Set Volume**.
- **Function Keys are set to Adjust Volume** — You can use your programmable **SIDE** buttons to adjust volume.



Note: The **ROTARY KNOB** and the **SIDE** buttons are paired. When the **ROTARY KNOB** mode is set to **Volume** or **Dual**, the **SIDE** buttons support the One-Touch Button feature.

Related Links

[One-Touch Button Feature](#) on page 33

Setting Rotary Lock

Procedure:

- 1 From the home screen, press the **MENU** key.
- 2 Select **Setup** → **Rotary Knob** → **Rotary Lock**.
- 3 Select one of the following:
 - **Locked** — Locks **ROTARY KNOB**, you can unlock it by selecting **Unlocked** or by pressing and holding **ROTARY KNOB**.
 - **Unlocked** — Unlocks the **ROTARY KNOB**.
 - **Disabled** — Locking function is unavailable. Your **ROTARY KNOB** is unlocked all the time.

Setting In Keypad Lock

When and where to use: To set behavior of the rotary knob when the keypad is locked.

Procedure:

- 1 From the home screen, press the **MENU** key.

- 2 Select **Setup** → **Rotary Knob** → **In Keypad Lock**.
- 3 Select one of the following:
 - **Lock None** — Scrolling and volume setting functionality is available.
 - **Lock Volume** — ROTARY KNOB can be only used for scrolling.
 - **Lock Scroll** — ROTARY KNOB can be only used for setting the volume.
 - **Lock Both** — Scrolling and volume setting functionality is unavailable.

Setting Rotary Knob Wrap Around

Procedure:

- 1 From the home screen, press the MENU key.
- 2 Select **Setup** → **Rotary Knob** → **Wrap Around**.
- 3 Select one of the following:
 - **On** — Scrolling through the talkgroup list is looped or is moved to the next folder.
 - **Off** — Scrolling through the talkgroup list stops after reaching first or last talkgroup in the current selected folder.



Note: Only when **Wrap Around** is set to **On** and the **Scroll Range** is set to **Scroll To Next**, you are able to scroll through all the talkgroups and folders.

Setting Rotary Knob Scroll Range

Procedure:

- 1 From the home screen, press the MENU key.
- 2 Select **Setup** → **Rotary Knob** → **Scroll Range**.
- 3 Select one of the following:
 - **Stay In Range** — Scrolling through the talkgroups in the current folder only.
 - **Scroll To Next** — Scrolling through all the talkgroups and folders.



Note: Only when **Wrap Around** is set to **On** and the **Scroll Range** is set to **Scroll To Next**, you are able to scroll through all the talkgroups and folders.

Setting Rotary Knob Talkgroup Selection

Procedure:

- 1 From the home screen, press the MENU key.
- 2 Select **Setup** → **Rotary Knob** → **Confirm TG Sel.**
- 3 Select one of the following:
 - **On** — You need to confirm the talkgroup selection by pressing **Select** or pressing the PTT button to immediately start a call on a new talkgroup.
 - **Off** — Attaches to the selected talkgroup without any additional prompt

Setting Rotary Knob Function Keys

Procedure:

- 1 From the home screen, press the MENU key.
- 2 Select **Setup** → **Rotary Knob** → **Function Keys**.
- 3 Select one of the following:
 - **Auto** — Sets the SIDE buttons according to the **Rotary Mode**.



Note: If the **Rotary Mode** is set to:

- **Dual or Volume** — Display shows **Auto Selected (OTB)**, volume can be set only through ROTARY KNOB.
- **Scroll** — Display shows **Auto Selected (Volume)**, volume can be set only through SIDE buttons.
- **Volume Adjust.** — Sets the SIDE buttons to adjust volume level.
- **OTB Feature** — Sets the SIDE buttons to the predefined One-Touch Button features.

Group Setup

This sub-menu allows you to set the scanning and my groups folder.

Scan

This menu item allows you to activate/deactivate scanning, view the active scan list, and edit the scan lists. This feature is available only for the TMO Mode. Your radio joins any group call as long as this group is defined in the scan list and scan is turned on.

Related Links

[Activating Talkgroup Scanning](#) on page 32

Activating Talkgroup Scanning

When and where to use: If you want to monitor any TMO Group Call in the defined talkgroup list.

Procedure:

- 1 From the home screen, press the MENU key.
- 2 Select **More . . .** → **Group Setup** → **Scan** → **Scanning**.
- 3 Select **Select List** and then a list name.
Your radio displays list name **Selected**.
- 4 Select **Scanning** → **On**.

Your radio is scanning on the predefined scan list.

Related Links

[Scan](#) on page 85

Setting Talkgroups in the Active Scan List

When and where to use: If you want to edit talkgroups in the active scan list.

Procedure:

- 1 From the home screen, press the MENU key.
- 2 Select **More . . .** → **Group Setup** → **Scan** → **Active List**.



Note: If **Scanning is Off** is displayed, go to **More . . .** → **Group Setup** → **Scan** → **Scanning** → **On** to enable scanning.

- 3 Select **View** and highlight the required talkgroup.
- 4 Press MENU.
- 5 Select one of the following:
 - **Delete** — Erases this group from the active scan list.
 - **Priority** and select new priority to **Low**, **Medium** or **High**.

Setting Scan Lists

When and where to use: If you want to set up any scan list.

Procedure:

- 1 From the home screen, press the **MENU** key.
- 2 Select **More . . .** → **Group Setup** → **Scan** → **Scan Lists**.
- 3 Highlight required scan list and press **MENU** to see additional settings:
 - **Capacity** — Displays the number of assigned and unassigned talkgroups for the scan list.
 - **Clear** — Deletes all the talkgroup assigned to that scan list.
 - **Add Group** — Adds a talkgroup to the scan list. Select one talkgroup from your talkgroup folders and assign appropriate priority.
 - **Edit** — Changes the priority of the required talkgroup or deletes it.

Deleting Talkgroups from Scan Lists

Procedure:

- 1 From the home screen, press the **MENU** key.
- 2 Select **More . . .** → **Group Setup** → **Scan** → **Scan Lists**.
- 3 Highlight the required scan list and press **MENU** → **Edit**.
- 4 Highlight the required talkgroup and press **MENU** → **Delete**.

My Groups

My Groups is equivalent to **Favorites** (next section). Both menu items contain shortcuts to favorite talkgroups and contact numbers, as well as allow to perform the same operations. For a detailed description of the feature, please refer to **Favorites**.

Favorites

Favorites contains shortcuts to frequently used talkgroups and contact numbers that are organized in favorite folders.

To quickly access favorite folders, from the home screen press the up **NAVIGATION** key. To scroll through items inside favorite folders, you can either use the **NAVIGATION** keys or the **ROTARY KNOB**.

Favorite Folders

Favorite talkgroups and contact numbers are stored in favorite folders. The folders are common for all types of talkgroups and contact numbers, which means that in one folder you can have items available in different modes. Additionally, to indicate the type of each item, the radio displays a small icon next to it.

By default the radio has one favorite folder that can store up to 128 favorite items. However, you can create two additional folders inside **Favorites** (three in total).

If **Favorites** contains only one favorite folder and it is empty, the only operations you can perform are adding an item to the folder and creating a new folder.

Favorite Talkgroups

You can add any talkgroup programmed in the radio to **Favorites**. The radio adjusts the mode it is in according to the currently selected favorite talkgroup. For example, if the radio is in **DMO** and you select a **TMO** talkgroup, the radio switches to **TMO**, and vice versa.

Scrolling through favorite talkgroups during an ongoing group call does not terminate the call. Also deleting a currently selected talkgroup from **Favorites** during an ongoing call does not lead to the call termination.

If before powering off the last selected talkgroup was a talkgroup from **Favorites**, the radio:

- On powering up in DMO attaches to the last selected favorite DMO talkgroup.
- On powering up in TMO attaches to the last selected favorite TMO talkgroup.

To make a call on a favorite talkgroup, use the standard procedures for group calls described in this document.

Favorite Contact Numbers

You can add any contact number from **Contacts** to **Favorites**. In case of contacts containing more than one contact number, you need to use the right or left NAVIGATION key to specify which particular contact number to add. There are no limitations regarding adding single contact numbers assigned to one contact – you can add all contact numbers as separate entries. Removing a single contact number from **Contacts** automatically removes it from **Favorites**. Similarly, removing a contact from **Contacts** automatically removes all the related contact numbers from **Favorites**.

It is impossible to make a call to a favorite contact number during emergency operations.

Making Private Calls to Favorite Contact Numbers

Procedure:

- 1 To select a contact number you want to call, from the home screen do one of the following:
 - Press the right or left NAVIGATION key.
 - Go to **Optns** → **TG by Folder**, select the required favorite folder, and highlight the contact number.
- 2 When you are in the following mode:
 - a TMO — For a simplex call, press and release the PTT button. You hear a ringing tone. Otherwise, press and hold the PTT button. Wait for the talk permit tone before talking, and release the PTT button to listen. For a duplex call, press and release SEND key. You hear a ringing tone.
 - b DMO — Only simplex call is available. Press and hold the PTT button. Wait for the talk permit tone before talking, and release the PTT button to listen.
- 3 To end the call, press the END key.

Adding Folders to Favorites

Prerequisites: **Favorites** contains less than three favorite folders.

Procedure:

- 1 From the home screen, press the MENU key.
- 2 Select **More . . .** → **Favorites**.
- 3 Select **[New Folder]**.

Adding Contact Numbers to Favorites

Procedure:

- 1 From the home screen, press the MENU key.
- 2 Select **Contacts**
- 3 Highlight a contact that you want to add to **Favorites** and using the left or right NAVIGATION key select the required number.
- 4 Press the MENU key and select **Add to Favorites**.
- 5 Select a folder you want to add the contact number to and press **Select**.

Adding Talkgroups to Favorites

Prerequisites:

To add a DMO talkgroup, ensure that the radio is in DMO.

To add a TMO talkgroup, ensure that the radio is in TMO.

Procedure:

- 1 From the home screen, press the **Optns** key.
- 2 Select one of the following:
 - **TG by Folder** – contains talkgroups arranged by folders.
 - **TG by abc** – contains talkgroups arranged alphabetically.
- 3 Find and highlight a talkgroup that you want to add to **Favorites**.
- 4 Press the MENU key and select **Add to Favorites**.
- 5 Select a folder you want to add the talkgroup to and press **Select**.

Related Links

[Entering DMO Mode](#) on page 44

Deleting Folders from Favorites

Procedure:

- 1 From the home screen, press the MENU key.
- 2 Select **More . . .** → **Favorites**.
- 3 Find and highlight a required folder.
- 4 Press the MENU key.
- 5 Select **Delete Folder**. Press **Yes** to confirm deletion.



Note: You cannot delete the last favorite folder or a folder that contains at least one non-erasable talkgroup.

Deleting Items from Favorites Folder

When and where to use: To delete a single contact number or a talkgroup from a favorite folder.

Procedure:

- 1 From the home screen, press the MENU key.
- 2 Select **More . . .** → **Favorites**.
- 3 Select a folder containing the item you want to remove.
- 4 Highlight the item and select **Delete**. Press **Yes** to confirm deletion.

Deleting All Items from Favorite Folders

When and where to use: To delete all contact numbers and talkgroups stored in a favorite folder.

Procedure:

- 1 From the home screen, press the MENU key.
- 2 Select **More . . .** → **Favorites**.
- 3 Select a required folder.
- 4 Press the MENU key and select **Delete All**. Press **Yes** to confirm deletion.

My Info

This sub-menu allows you to view your own private, phone, and radio info.

Viewing and Modifying Personal Information

Procedure:

- 1 From the home screen, press the **MENU** key.
- 2 Select **More . . .** → **My Info**.
- 3 Select one of the following:
 - **My Private Num** – displays your radio private number.
 - **My Phone Num** – displays your radio phone number.



Note: To modify the displayed phone number, select **Edit**. Type the number and press **Ok**.

- **Radio Info** – displays radio information: manufacturer, product type, ISSI, TEI, Serial Number, and OPTA.



Note: OPTA information is optional.

Recent Calls

You can view the history of all calls:

- **Dialed** — calls you initiated.
- **Received** — calls you answered.
- **Missed** — calls you received but not answered or rejected.

Each list of calls may contain up to 50 numbers, the most recent call being at the top of the list. If the number of a recent call is stored in the contact list, the name associated with the number appears in the recent calls list. A number dialed more than once, appears only once in the list.

Viewing Recent Calls

Procedure:

- 1 From the home screen, press the **MENU** key.
- 2 Select **More . . .** → **Recent Calls**.
- 3 Select one of the following:
 - **Dialed**
 - **Received**
 - **Missed**
- 4 Select a required call from the list.
- 5 Press the **MENU** key.
- 6 Select **View**.



Suggestion: Press down **NAVIGATION** key to bypass first two steps.



Note: Call time information is only available if the time and date are set in the radio. Call duration is not available in the missed calls list.

Calling from Recent Calls

Procedure:

- 1 From the home screen, press the **MENU** key.
- 2 Select **More . . .** → **Recent Calls**.
- 3 Select one of the following:
 - **Dialed** (from the home screen press **SEND** key to access **Dialed Calls** list)
 - **Received**
 - **Missed**



Note: From the home screen press down **NAVIGATION** key, to access **Recent Calls** menu item.

- 4 Highlight the required call and press the **PTT** button for private calls or press the **SEND** key to make a phone call.



Note: Phone calls are only available in **TMO Mode**.

Storing Recent Calls to Contacts

Procedure:

- 1 From the home screen, press the **MENU** key.
- 2 Select **More . . .** → **Recent Calls**.
- 3 Select **Dialed**, **Received** or **Missed**.
- 4 Press **Store**.



Note: If **Store** is not assigned to the left **SOFT** key, the number is already stored in your contact list.

- 5 To store the number as a new entry, select **[New Contact]**. Or, to store the number to an existing entry, select the entry, and press **View** then select **Edit**.
- 6 With the contact type field highlighted, scroll left or right to display the contact type you want to assign the number.
- 7 Select **Done**.

Deleting Recent Calls

Procedure:

- 1 From the home screen, press the **MENU** key.
- 2 Select **More . . .** → **Recent Calls**.
- 3 Select **Dialed**, **Received** or **Missed**.
- 4 Press **MENU** on the required call.
- 5 Select **Delete**.



Note: To erase all the calls, select **Delete All**.

Networks

This menu item allows you to switch between the radio operation modes.

Related Links

[Entering TMO / DMO Mode](#) on page 30

[Selecting Network Operation Mode](#) on page 91

Selecting Network Operation Mode

Procedure:

- 1 From the home screen, press the **MENU** key.
- 2 Select **More . . .** → **Networks**.
- 3 Select one of the following:
 - **Networks Sel** — Selects the network to which the radio is allowed to register.
 - **Trunked Mode** — Switches to the mode using infrastructure.
 - **Direct Mode** — Switches to the mode without using infrastructure.
 - **TXI Mode** — Select **Activate** to stop sending any radio transmission.



Note: If the radio is in **TXI Mode**, it is not possible to switch from **Direct Mode** to **Trunked Mode**.

Related Links

[Entering TMO / DMO Mode](#) on page 30

[Networks](#) on page 90

Selecting Your Network

Procedure:

- 1 From the home screen, press the **MENU** key.
- 2 Select **More . . .** → **Networks** → **Networks Sel** → **Home Only**.
- 3 Your radio registers to the home network. If several home networks are defined, the radio registers to the first available network on the list.

Using the Select Net Registration

Procedure:

- 1 From the home screen, press the **MENU** key.
- 2 Select **More . . .** → **Networks** → **Networks Sel** → **Select Net**.
- 3 Select the required network from the list.

Your radio registers to the selected network.

Using the Foreign Network Registration

When and where to use: Use this feature to migrate to another predefined network, when you are out of the range of your network and your radio displays the **No Service** message.

Procedure:

- 1 From the home screen, press the **MENU** key.
- 2 Select **More . . .** → **Networks** → **Networks Sel** → **Foreign Nets**.

Using Any Network

When and where to use: Your radio has lost its home network coverage and can register to any network. Only clear authentication is supported on any network.

Procedure:

- 1 From the home screen, press the **MENU** key.

- 2 Select **More . . .** → **Networks** → **Networks Sel** → **Any Network**.
- 3 Your radio selects and registers to the network automatically from the predefined list.

Using the Migrate To Registration

When and where to use: Use this feature to migrate to another predefined network, when you are out of the range of your network and your radio displays the **No Service** message.

Procedure:

- 1 From the home screen, press the MENU key.
- 2 Select **More . . .** → **Networks** → **Networks Sel** and choose one of the following option:
 - **Migrate to...** — Selects the required network form the list. To view the network ID press MENU key then press Select.
 - **Auto** — Your radio automatically attaches to the predefined network.

Location

See the GPS Location Service for more information.

Related Links

[GPS Location Service](#) on page 53

Viewing Your Position

Procedure:

- 1 From the home screen, press the MENU key.
- 2 Select **More . . .** → **Location** → **Position**.
- 3 Scroll to view the results about the last time your location was calculated.



Note: To refresh your position:

- Select **Position** — the radio refreshes its position automatically
- Press **Refresh**

Changing GPS Accuracy

Procedure:

- 1 From the home screen, press the MENU key.
- 2 Select **More . . .** → **Location** → **Accuracy**.
- 3 Select one of the following:
 - **Medium** (default) — Power consumption optimization is combined with less position accuracy.
 - **High** — Better position accuracy is combined with less power consumption optimization.



Note: If connected to an external charging device, the radio automatically enters the **High** mode.

Packet Data

The Packet Data (PD) Service allows you to transfer data in a TETRA system using the Internet Protocol (IP).



Note: To transfer data from a standard computer over the air, connect the computer via the data cable PMKN4025 with your radio. Your service provider has to setup additional applications on your computer.

If set up by your service provider it is possible to accelerate the transmission by using the Multi-Slot Packet Data (MSPD) Service.



Note: This is a selling feature.

Viewing Data Statistics

Procedure:

- 1 From the home screen, press the MENU key.
- 2 Select **More . . .** → **Packet Data**.



Note: Data services are only available in TMO Mode. The data option must be set to **Voice & Data** or **Data Only**.

- 3 Select one of the following:
 - **Sent Data** — the number of KBs sent and throughput since current Packet Data activation is displayed.
 - **Received Data** — the number of KBs received and throughput since current Packet Data activation is displayed.
 - **Bandwidth** — active data session percentage is shown.
 - **Failed Transfer** — the percentage of failed sent/received packets.



Note: N.A. — standby packet data session.

Viewing Encryption Status

Procedure:

- 1 From the home screen, press the MENU key.
- 2 Select **More . . .** → **Packet Data** → **Encryption**.
- 3 The encryption state of the ongoing packet data session is displayed:
 - **Packet Data Channel Clear**
 - **Packet Data Channel Encrypted**
 - **EncryptionN/A** (clear)

Chapter 6

Features

Private Call

The Private Call, also called point-to-point, or individual call, enables calling between two individuals. No other radio can hear the conversation. This call type can be carried out in two ways:

- Duplex call (if the system allows), in TMO Mode. Both parties can speak at the same time.
- Simplex call, in TMO or DMO Mode. Only one party can speak at a time.

When a DMO Private Call takes place, radios not involved in this call receive the channel busy indication. The radios are identified using its radio numbers.

Related Links

[Emergency Individual Calls \(Private or MS-ISDN\)](#) on page 50

Making Private Calls

Prerequisites: Direct Private Number Dialing is assigned to the right NAVIGATION key.

Procedure:

- 1 From the home screen, press and hold the right NAVIGATION key and enter a number.
- 2 If **Private** is not the first type of call presented, press **Ctype** repeatedly to select it.
- 3 When you are in the following mode:
 - a TMO — For simplex calls, press and release the PTT button. You hear a ringing tone. Otherwise, press and hold the PTT button. Wait for the talk permit tone before talking, and release the PTT button to listen. For duplex calls, press and release the SEND key. You hear a ringing tone.
 - b DMO — Only simplex calls are available. Press and hold the PTT button. Wait for the talk permit tone before talking, and release the PTT button to listen.
- 4 To end the call, press the END key.

Dialing through Soft Numeric Keypad

Prerequisites: Direct Private Number Dialing is assigned to a right NAVIGATION key.

Procedure:

- 1 From the home screen, press and hold right NAVIGATION key.
Your radio displays dialing number prompt.
- 2 Rotate the ROTARY KNOB or press up/down NAVIGATION key to choose the number, then press the knob or right NAVIGATION key to go to the next digit.

**Note:**

- You can enter # at the end when the Speed Dialing feature is enabled.
- The + sign you can enter only when you are editing the first position. Both signs are available after digit 9.

- 3 Press the PTT or the SEND key (only in TMO).

Phone and PABX Calls

The Phone Call allows you to call a landline telephone number or a cellular mobile phone number. The Private Automatic Branch Exchange (PABX) Call allows you to call local (office) extension numbers.

Making Phone or PABX Calls

Prerequisites: Direct Private Number Dialing is assigned to the right NAVIGATION key.

Procedure:

- 1 From the home screen, press and hold right NAVIGATION key and enter the number.
- 2 If **Phone** or **PABX** are not the first type of call presented, press **Ctype** repeatedly to select it.
- 3 Press SEND key.

Phone/PABX Speed Dial

This feature allows you to dial Phone/PABX by a shortened number of up to three digits instead of the full number. The Phone/PABX **Speed #** number is assigned when the dialed number is added in the contact list.



Note: This feature is available only in TMO Mode.

Using the Phone/PABX Speed Dial

Procedure:

- 1 From the home screen, enter the predefined Phone/PABX speed dial number and # key.
- 2 Press SEND key.

DTMF Overdial

This feature allows you to communicate with an automated answering device (for example, the voice mail or answering machine) during an on-going private, phone or PABX call.

While in an on-going private, phone or PABX call, press the DTMF keys (0-9, *, #). When pressed, the DTMF key sounds a tone and the entered digit is displayed on the screen.

Short Number Dial

This feature allows you to dial part of the full number of the person you wish to call. Your radio automatically completes the number.

Your radio number is 4282564.

- 1 Dial 564 (instead of 4282564, the full number).
- 2 To place the call, press the PTT button or the SEND key.

Call-Out

This feature allows you to receive Call-Out alerts. On receiving the Call-Out messages, the radio interrupts current services and attends to the Call-Out alert without any further delay. After call-out alert has been cleared, the radio exits Call-Out mode and reverts to normal mode. During Call-Out mode you are only able to receive Emergency Calls.



Note: To read an entire Call-Out message, scroll down the screen by pressing the down NAVIGATION key. The length of the message is indicated by the vertical red bar on the left of the screen.

Figure 3: Call-Out Message



Note: This is a selling feature.

Related Links

[CO Box](#) on page 63

Types of Call-Out Alerts

There are four types of the Call-Out alerts:

- Normal Call-Out – an alert message that is sent by a dispatcher either to a single radio or to a group of radios.
- Storm Plan – an alert message that is sent by a dispatcher to a group of radios. To raise its reliability, it is sent several times. You are not able to respond to the Call-Out alert and any key press takes you to the information phase.
- Fallback Mode – an alert message that is limited only to voice communication. To initiate this type of Call-Out, press a One-Touch key predefined by your service provider. It can be cleared manually.



Note: Fallback is only possible when the radio is in Local Site Trunking.

- Test Call-Out – a special Call-Out alert that is sent by the dispatcher to test this feature. On receiving the Test Call-Out, the radio plays a tone and displays **Test Call-Out**. To respond and clear the alert, press the **Test OKSOFT** key.

Call-Out Modes Interaction

Call-Out feature operation is different in other modes:

- TXI Mode — you can read the message but you cannot respond to it. You have an option to leave the TXI Mode by pressing soft key or reject the Call-Out message.
- DMO Mode — Call-Out is not supported.

- Emergency Mode — all Call-out alerts are ignored.

Call-Out Service Phases

In the Call-Out mode there are following phases:

- Alerting phase — receives a Call-Out message. The alarm tone indicates the message. Text is displayed and you have following options to use: **Accept**, **Reject** or **MENU**. If you accept the alert, no other service from this point can interrupt.



Note: You can stop the alert tone by pressing PTT or any of the soft keys.

- Information phase — you are still in the Call-Out mode and you can receive more detailed information about the incident that occurred through subsequent text or the voice message. You can query for more information using voice group call or Call-Out text function which enables you to send a text message. You can always respond and send back the text or the voice message using voice group call.

Shadow Groups (Address Bundle)

The Shadow Groups feature (also known as Address Bundle) offers a way of sending messages to multiple destinations or recipients simultaneously. Three types of messages are supported by the feature:

- Status messages (including Emergency Alarms)
- GPS LIP (TETRA Location Information Protocol) reports
- RMS/FMS messages

Shadow Groups in TMO

Each Shadow Group may contain up to four target addresses. Each talkgroup may be configured to send status messages, GPS LIP reports, or RMS/FMS messages to a specific Shadow Group.

Shadow Groups in DMO

In DMO, the Shadow Group contains one target address. Each talkgroup may be configured to send status messages or GPS LIP reports to a specific Shadow Group.

Each radio can store up to 255 Shadow Groups (both in TMO and DMO).

The Shadow Groups feature may affect Emergency Calls setup time to be slightly elongated.



Note: This is a selling feature and needs to be enabled by your service provider.

Appendix A

Tones

Table 18: Radio Tones

| Tone Name | Default Tone Diagram |
|---|--|
| Back to Coverage Back to Full Service |  |
| Clear-to-send |  |
| Bad Key Pressed |  |
| From Out-of-Service to In Service |  |
| In Emergency |  |
| Talk Permit |  |
| <ul style="list-style-type: none"> • Talk prohibit • System busy • Time-out timer expire • Called radio not available or busy |  |
| Call Disconnected or Failed Due to Network |  |

Table continued...

Tone Name **Default Tone Diagram**

Toggling Between DMO and TMO

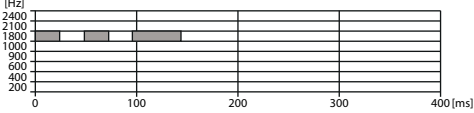
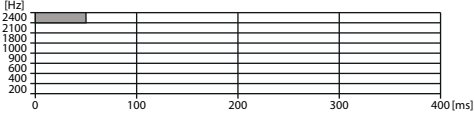
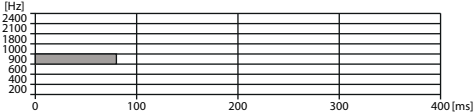
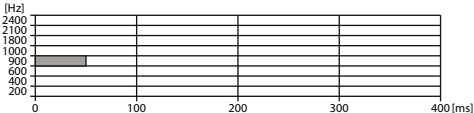
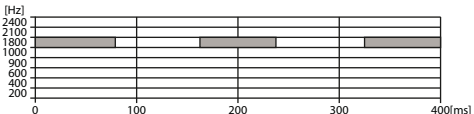
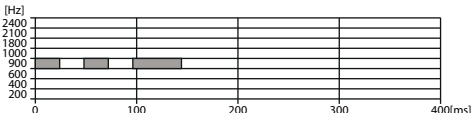
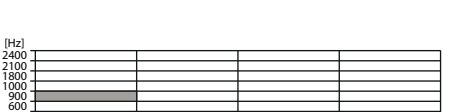
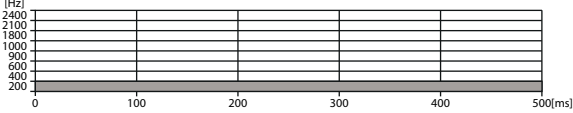
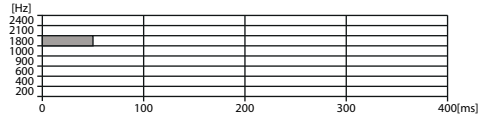

Entering/Exiting Local Site Trunking

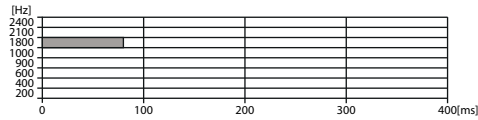

Receiving/Sending Emergency Alarm

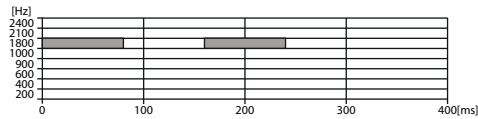

Emergency Alarm Failed

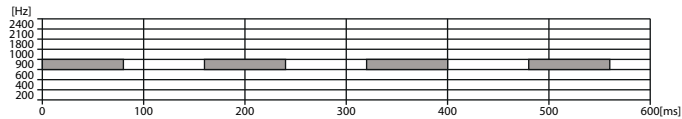

Entering Emergency

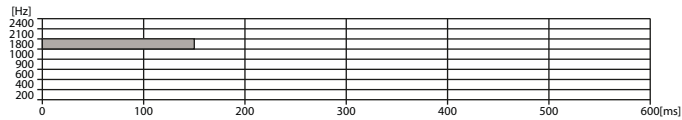

Exiting Emergency

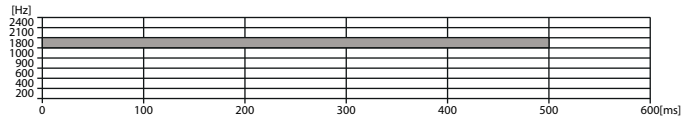

Entering/Exiting TXI

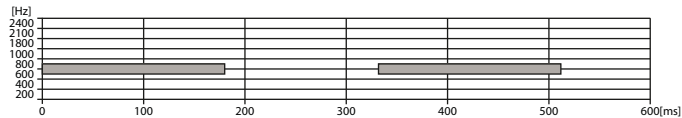

Low Battery Alert



Remote Control

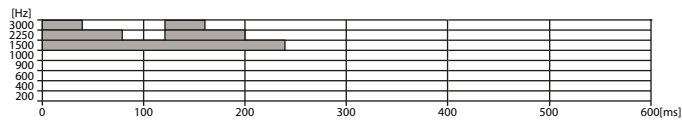

Note: All the audible indications can be disabled by your service provider.

Appendix

B

LED Indications

Table 19: LED Indications

| Indication | Status |
|-----------------|--|
| Solid green | In use |
| Blinking green | In service |
| Solid red | Out of service |
| Blinking red | Connecting to the network Entering DMO |
| Solid orange | Transmit inhibit in service Channel busy in DMO |
| Blinking orange | Incoming call |
| No indication | Idle Radio powered down |

Appendix

C

Troubleshooting

Your radio displays the following messages:

Table 20: Displayed Messages

| Message | Message Description |
|----------------------------------|---|
| ...-Received | Call received but not answered, or rejected. |
| Attachment Failed | Your radio could not perform talkgroup attachment. It keeps on trying. If it does not succeed, try another talkgroup. |
| Authenticate Failure | Your radio could not register on an authenticated system (for example, the Authentication Key is incorrect, or authentication is disabled). |
| Battery level too low. | The battery charge level is too low to perform the required operation. |
| Call Cancelled | You have canceled the call. |
| Call Ended | <ul style="list-style-type: none">Faulty channel. Please try later.You have ended the call. |
| Call Forwarding | The radio you are trying to call is not available and the call is being forwarded to another radio. |
| Call Modified | The call you are participating in has been modified. |
| Call Preempted | Channel being used for priority. |
| Decryption Failed: | An error occurred while decrypting a message or call. |
| Emergency In Use Wait For Mic | The Hot Microphone feature is active, but the channel transmit grant has been given to another Emergency call on the same talkgroup. Your radio microphone is not active during this time, but it automatically tries to regain talk permit after a predetermined time. |
| Emgcy Mic Ended | The Hot Microphone timer automatically expired, or you pressed the PTT button to cancel the Hot Microphone feature. |
| Emergency Mic On | The Hot Microphone feature is active, and your radio is automatically transmitting hands free emergency audio. |
| Empty Entry | The speed number you dialed does not exist, or the number exists but the group is non-selectable. |
| Faulty Unit Error | Self-test failed. An operational fault has been detected with your radio. Record the error number. Turn your radio off and contact service. |
| Gateway available | Your radio has connected to a gateway. |

Table continued...

| Message | Message Description |
|--|---|
| Gateway not available | Your radio cannot connect to a gateway, or connection has been lost. |
| This group already exists | The group you are attempting to add exists in the My Groups folder. |
| Individual Calls Only | You can make only individual (private) calls. |
| Insufficient visible data | Your radio is in the process of determining your location. This process may take several minutes to complete. |
| Insufficient visible satellites | Your radio is in the process of determining your location. This process may take several minutes to complete. |
| Invalid ID | The entered number is not valid. |
| Invalid Shortcut Position | The entered number is not valid. |
| Limited Service | Emergency Calls, Emergency Alarms, and mobility operations (for example group attachment) are allowed. All other incoming and outgoing call and data services are blocked. |
| List Empty | There are no programmed entries in the scrolling list. Type the entry. |
| List Not Attached | All talkgroups in the scan list are not attached. |
| List Partially Attached | The scan list is active, but not all talkgroups are attached to it. |
| Message Delivered | Indicates mail successfully delivered. |
| Message Failed | Indicates mail delivery failure. |
| New Delivery Status | You have received a new Delivery Status. |
| No Service | Your radio is outside coverage. Return to coverage. |
| Not allowed in repeater mode | The service or feature is not available in the Repeater Mode.. |
| My Groups Is Empty | You cannot view/delete groups when the My Groups folder is empty. |
| My Groups Is Full | You are not allowed to add a group to the My Groups folder as it already contains the maximum allowed number of groups. |
| Network Trouble | Network problems. Please try again later. |
| No Answer | The called party does not answer. |
| No Entries | This message is displayed when accessing an empty list. |
| No Group | <ul style="list-style-type: none"> Attachment failed. Your radio detached from current talkgroup. Please wait until it attaches again to the current talkgroup. Displayed when you are out of the normal coverage area of your selected talkgroup. Please select a new talkgroup that is valid for your working location. Indicates a favorite group was removed from the My Groups folder. |
| No List | The network list is empty. |
| No New or Old Messages | Indicates there are no new or old messages in the Inbox . |

Table continued...

| Message | Message Description |
|---|--|
| No Selected Scan List | You selected an empty network list. |
| No Service | Your radio is out of coverage. |
| Not Allowed To Initiate Call | You are not allowed to dial a number which is not in the address book. |
| Not Allowed To Transmit | Release the PTT button and try again later. You are not allowed to send a text message or a status message to a number which is not in the address book. |
| Single TalkGroup Only | There is only one programmed entry in the scrolling list. |
| Overheating, Please Turn Radio Off | Your radio turns off. Keep it turned off for 5 minutes. |
| Party Busy | Called radio is busy. |
| Party Not Available | Called radio is out-of-range or turned off. Please try again later. |
| Please Try Again | You could not call. |
| Please Wait Connecting | A message during startup. |
| Registration Failure | Your radio could not register within the system. Please try again later. |
| Repeater available | Your radio has connected to a repeater. |
| Repeater not available | Your radio cannot connect to a repeater, or connection has been lost. |
| Service Denied | Invalid number. Call your service provider. |
| Service Not Available | This service is not available on the current network. |
| Service Restricted | This service or feature is restricted by your service provider, it has not been purchased, or it is not available. |
| TalkGrp ... cannot be deleted | Your service provider set this group so you cannot delete it from the favorite talkgroup folder. |
| Try Again Later | The requested service is temporarily unavailable. |
| Radio Disabled | Check with your service provider. |
| Unit is OK Warn: | Self-test error. A minor fault has been detected. Your radio is still fully operative. If this error recur, note the error code and contact service. |
| Unit Not Attached | You radio could not attach to the system. The talkgroup may not be defined in the system. Please try another group. |

Appendix

D

Maintenance



Suggestion:

- Before using your radio for the first time, remove the plastic lens protector from the display, and charge the battery until the LED green light appears.
- Battery charging must occur only in non-hazardous areas.
- Clean the connector frequently and before the programming procedure for example, with a soft brush (do not use fluids).

Storage

- Do not store the battery where the temperatures exceed +65 °C or fall below -20 °C.
- New Lithium-Ion batteries may be stored in ventilated, cool and dry areas with some capacity loss in the life cycle.
- It is not recommended to store the batteries when they are fully charged or discharged.

Extending Battery Life

A battery is an expendable part and may need replacing during the life of the radio. To ensure maximum service life of your radio, always replace the battery with a genuine Motorola replacement. In order to ensure maximum life for your battery:

- Do not charge it unless necessary (low battery indication).
- Charge it until full charge indication is on.

Battery Charging Temperature

When the battery is fitted to the radio, it charges within the temperature range of 0 °C to 45 °C. When the battery is charged separately (without the radio), the temperature range of battery operation is from 0 °C to +45 °C in charger mode, and from -10 °C to +60 °C in discharge mode.

If, during charging, the temperature is out of range, the battery might not be fully charged since the charging is temporarily stopped until the temperature becomes suitable.

Battery Charging Rules

Generally, to reduce the number of charge cycles as much as you can, wait for the **Low Battery** message to charge, as it ensures maximum battery life. Do not use your charger as a radio holder or leave your radio and fully charged battery connected to the charger while not charging. Continuous charging shortens the battery life.

Additional Battery Warnings/Cautions

- Battery storage above 60 °C and below -20 °C is not recommended.
- To prevent injury, do not allow metal objects to touch the battery contacts.
- Do not disassemble.
- Do not throw in fire.
- Do not dispose of battery in household waste.

Looking after Your Radio

Never leave your radio or battery in extreme temperatures (over 60 °C), for example, behind a windscreen in direct sunlight.

Do not immerse your radio in water.

To clean your radio, use a moistened or antistatic cloth.