



# APX TWO-WAY RADIOS

MODEL 1

---

# APX 7000XE USER GUIDE

**DECEMBER 2019**

© 2019 Motorola Solutions, Inc. All rights reserved



68012002071-KK

# Contents

<b>Declaration of Conformity</b> .....	<b>8</b>
<b>Important Safety Information</b> .....	<b>10</b>
<b>Notice to Users (FCC and Industry Canada)</b> .....	<b>11</b>
<b>Software Version</b> .....	<b>12</b>
<b>Computer Software Copyrights</b> .....	<b>13</b>
<b>Documentation Copyrights</b> .....	<b>14</b>
<b>Disclaimer</b> .....	<b>15</b>
<b>Read Me First</b> .....	<b>16</b>
Notations Used in This Manual.....	16
Radio Maintenance.....	16
Radio Care.....	16
Cleaning Your Radio.....	18
Radio Service and Repair.....	18
Cleaning the External Surface of the Radio.....	18
Battery Care.....	19
Battery Charge Status.....	19
Battery Recycling and Disposal.....	19
Additional Performance Enhancement.....	20
ASTRO 25 Enhanced Data.....	20
Dynamic System Resilience (DSR).....	20
CrossTalk Prevention.....	20
Encrypted Integrated Data (EID).....	20
SecureNet.....	20
Over-the-Air Rekeying.....	20
P25 Digital Vehicular Repeater System (DVRS).....	20
Conventional Talkgroup and Radio Scan Enhancements.....	21
What Your Dealer/System Administrator Can Tell You.....	21
<b>Preparing Your Radio for Use</b> .....	<b>22</b>
Charging the Battery.....	22
Attaching the Battery .....	22
Attaching the Antenna.....	23
Removing and Attaching the Accessory Connector Cover.....	24
Attaching the Belt Clip.....	25
Turning On the Radio .....	25
Adjusting the Volume.....	26

<b>Radio Controls</b> .....	<b>28</b>
Radio Parts and Controls.....	28
Programmable Features.....	29
Assignable Radio Functions.....	29
Assignable Settings or Utility Functions.....	31
Accessing the Preprogrammed Functions.....	31
Push-To-Talk (PTT) Button.....	31
<b>Status Indicators</b> .....	<b>32</b>
Status Icons.....	32
LED Indicator.....	34
Intelligent Lighting Indicators.....	35
Alert Tones .....	36
Display Color Change On Channel.....	38
HAZLOC Battery Type Detection.....	38
<b>General Radio Operation</b> .....	<b>39</b>
1.1 Selecting a Zone.....	39
1.2 Selecting a Radio Channel.....	39
1.3 Receiving and Responding to a Radio Call.....	39
1.3.1 Receiving and Responding to a Talkgroup Call.....	39
1.3.2 Receiving and Responding to a Private Call (Trunking Only).....	40
1.3.3 Receiving and Responding to a Telephone Call (Trunking Only).....	40
1.4 Methods to Make a Radio Call.....	41
1.4.1 Making a Talkgroup Call .....	41
1.4.2 Making a Private Call (Trunking Only).....	41
1.4.3 Making an Enhanced Private Call (Trunking Only).....	42
1.5 Switching Between Repeater or Direct Operation Button.....	42
1.6 Monitor Feature.....	42
1.6.1 Monitoring a Channel.....	43
1.6.2 Monitoring Conventional Mode.....	43
<b>Advanced Features</b> .....	<b>44</b>
2.1 ViQi.....	44
2.1.1 Using ViQi Virtual Partner.....	45
2.2 Advanced Call Features.....	45
2.2.1 Selective Call (ASTRO Conventional Only).....	45
2.2.1.1 Receiving a Selective Call.....	45
2.2.1.2 Making a Selective Call.....	45
2.2.2 Making a Priority Dispatch Calls.....	46
2.2.3 Dynamic Regrouping (Trunking Only).....	46
2.2.3.1 Requesting a Reprogram (Trunking Only).....	47

2.2.3.2 Classification of Regrouped Radios.....	47
2.3 Scan Lists.....	47
2.3.1 Intelligent Priority Scan.....	47
2.3.2 Viewing a Scan List.....	48
2.3.3 Viewing and Changing the Priority Status.....	48
2.4 Scan.....	48
2.4.1 Turning Scan On or Off.....	48
2.4.2 Making a Dynamic Priority Change (Conventional Scan Only).....	48
2.4.3 Deleting a Nuisance Channel.....	49
2.4.4 Restoring a Nuisance Channel.....	49
2.5 Call Alert Paging.....	49
2.5.1 Receiving a Call Alert Page.....	50
2.5.2 Sending a Call Alert Page.....	50
2.6 Emergency Operation.....	50
2.6.1 Exiting Emergency.....	51
2.6.2 Exiting Emergency as Supervisor (Trunking Only).....	51
2.6.3 Sending an Emergency Alarm.....	52
2.6.4 Sending an Emergency Call (Trunking Only).....	52
2.6.5 Sending An Emergency Call With Hot Mic (Trunking Only).....	52
2.6.6 Sending an Emergency Alarm with Emergency Call.....	53
2.6.7 Sending An Emergency Alarm and Call with Hot Mic.....	54
2.6.8 Sending a Silent Emergency Alarm.....	54
2.6.9 Special Considerations for Emergencies.....	55
2.6.10 Emergency Keep-Alive.....	55
2.7 Fireground.....	55
2.7.1 Entering Fireground Zone Channel (Conventional).....	56
2.7.2 Sending Evacuation Tone.....	56
2.7.3 Responding to Evacuation Indicator.....	57
2.8 Tactical Public Safety (TPS) (Conventional Only).....	57
2.8.1 Using TPS Normal Transmission.....	57
2.8.2 Using TPS Emergency Transmission.....	57
2.9 Man Down.....	58
2.9.1 Pre-Alert Timer.....	59
2.9.2 Post-Alert Timer.....	59
2.9.3 Radio Alerts When Man Down Feature is Triggered.....	59
2.9.4 Triggering Emergency.....	59
2.9.5 Radio Alerts When Man Down Enhanced is Triggered.....	60
2.9.6 Exiting Man Down Feature.....	60
2.9.7 Re-Initiating Man Down.....	60

2.9.8 Testing the Man Down Feature.....	61
2.10 Secure Operations.....	61
2.10.1 Selecting Secure Transmissions.....	61
2.10.2 Selecting Clear Transmissions .....	61
2.10.3 Managing Encryption.....	62
2.10.3.1 Loading Encryption Keys.....	62
2.10.3.2 Multikey Feature.....	62
2.10.3.3 Erasing Encryption Keys.....	63
2.10.3.4 Requesting an Over-the-Air Rekey.....	63
2.10.3.5 MDC Over-the-Air Rekeying Page (Conventional Only).....	63
2.10.3.6 Infinite UKEK Retention.....	64
2.10.3.7 Hear Clear.....	64
2.11 Radio Inhibit.....	64
2.12 Global Positioning System/Global Navigation Satellite System.....	64
2.12.1 GPS Operation.....	65
2.12.2 GPS Performance Enhancement.....	65
2.12.3 Location Format.....	65
2.12.4 Peer-Location on the Display (ASTRO Conventional only).....	66
2.13 Trunking System Controls.....	66
2.13.1 Operating in Failsoft System.....	66
2.13.2 Out-of-Range Radio.....	67
2.13.3 Site Trunking Feature.....	67
2.13.4 Locking and Unlocking a Site.....	67
2.13.5 Site Display and Search Button.....	67
2.13.5.1 Viewing the Current Site.....	67
2.13.5.2 Changing the Current Site.....	68
2.14 Mission Critical Wireless - Bluetooth® .....	68
2.14.1 Turning On Bluetooth .....	68
2.14.2 Turning Off the Bluetooth.....	68
2.14.3 Re-Pair Timer.....	69
2.14.4 Bluetooth Drop Timer.....	69
2.14.5 Pairing with Low Frequency-Motorola Proximity Pairing (LF-MPP) Feature.....	70
2.14.6 Radio Indications of Lost Bluetooth Connection.....	71
2.14.7 Standard Pairing Feature.....	71
2.14.7.1 Searching and Pairing the Bluetooth Device.....	71
2.14.7.2 Turning On Bluetooth Visibility.....	72
2.14.7.3 Receiving Pairing Request from other Devices.....	72
2.14.8 Turning On the Bluetooth Audio.....	72
2.14.9 Turning Off the Bluetooth Audio.....	73

2.14.10 Adjusting the Volume of the Radio from Bluetooth Audio Device.....	73
2.14.11 Clearing All Bluetooth Devices Information.....	73
2.14.12 Pairing with LEX Handheld.....	74
2.14.13 Responder Alert Sensors.....	74
2.14.13.1 Holster Sensor.....	74
2.14.13.2 Disabling the Sensor.....	75
2.15 Over-the-Air Programming (POP 25, ASTRO 25, and ASTRO Conventional) .....	75
2.16 Voice Announcement .....	76
2.17 Site Selectable Alerts (ASTRO 25).....	76
2.18 Utilities.....	77
2.18.1 Using the Flip Display.....	77
2.18.2 Selecting a Basic Zone Bank.....	77
2.18.3 Selecting the Power Level.....	77
2.18.4 Controlling the Display Backlight.....	78
2.18.5 Locking and Unlocking the Controls.....	78
2.18.6 Turning Voice Mute On or Off.....	78
2.18.7 Using the Time-Out Timer.....	79
2.18.8 Using Conventional Squelch Operation Features.....	79
2.18.8.1 Analog Options.....	79
2.18.8.2 Digital Options.....	79
2.18.9 Using the PL Defeat Feature.....	80
2.18.10 Digital PTT ID Support.....	80
2.18.11 Smart PTT (Conventional Only).....	80
2.18.12 Transmit Inhibit.....	81
2.18.12.1 Enabling Transmit Inhibition.....	81
2.18.12.2 Disabling Transmit Inhibition.....	81
2.18.13 Instant Recall.....	82
2.18.13.1 Saving and Playback Calls.....	82
<b>Accessories.....</b>	<b>83</b>
<b>Maritime Radio Use in the VHF Frequency Range.....</b>	<b>84</b>
4.1 Special Channel Assignments.....	84
4.1.1 Emergency Channel.....	84
4.1.2 Non-Commercial Call Channel.....	84
4.2 Operating Frequency Requirements.....	84
4.3 Declaration of Compliance for the Use of Distress and Safety Frequencies.....	87
4.4 Technical Parameters for Interfacing External Data Sources.....	87
<b>Glossary.....</b>	<b>88</b>
<b>Limited Warranty.....</b>	<b>93</b>
6.1 MOTOROLA SOLUTIONS COMMUNICATION PRODUCTS.....	93

6.2 I. WHAT THIS WARRANTY COVERS AND FOR HOW LONG:.....	93
6.3 II. GENERAL PROVISIONS:.....	94
6.4 III. STATE LAW RIGHTS:.....	94
6.5 IV. HOW TO GET WARRANTY SERVICE:.....	94
6.6 V. WHAT THIS WARRANTY DOES NOT COVER:.....	94
6.7 VI. PATENT AND SOFTWARE PROVISIONS:.....	95
6.8 VII. GOVERNING LAW:.....	96
6.9 VIII. For Australia Only.....	96

# Declaration of Conformity

This declaration is applicable to your radio only if your radio is labeled with the following FCC logo.  
Per FCC CFR 47 Part 2 Section 2.1077(a)



## Responsible Party

Name: Motorola Solutions, Inc.

Address: 1303 East Algonquin Road, Schaumburg, IL 60196-1078, U.S.A.

Phone Number: 1-800-927-2744

Hereby declares that **APX 7000XE** conforms to FCC Part 15, subpart B, section 15.107(a), 15.107(d), and section 15.109(a)

## Class B Digital Device

As a personal computer peripheral, this device complies with Part 15 of the FCC Rules. This device complies with Industry Canada license-exempt RSS standard(s). Operation is subject to the following two conditions:

- 1 This device may not cause harmful interference, and
- 2 This device must accept any interference received, including interference that may cause undesired operation.



### NOTICE:

This equipment has been tested and found to comply with the limits for a Class B digital device, pursuant to part 15 of the FCC Rules and Industry Canada license-exempt RSS standard. These limits are designed to provide reasonable protection against harmful interference in a residential installation. This equipment generates, uses, and can radiate radio frequency energy and, if not installed and used in accordance with the instructions, may cause harmful interference to radio communications. However, there is no guarantee that interference will not occur in a particular installation.

If this equipment does cause harmful interference to radio or television reception, which can be determined by turning the equipment off and on, the user is encouraged to try to correct the interference by one or more of the following measures:

- Reorient or relocate the receiving antenna.
- Increase the separation between the equipment and receiver.
- Connect the equipment into an outlet on a circuit different from that to which the receiver is connected.
- Consult the dealer or an experienced radio or TV technician for help.

## Additional FCC Note to Users

The following FCC information applies to Bluetooth radio options.

**Model Name:** MNUK6000

**Description:** APX 7000XE Bluetooth Option Board



**FCC ID:** AZ489FT6000

**IC:** 109U-89FT6000

**Conforms to the following regulations:** FCC Part 15, Section 15.19, 15.21, and 15.105



**NOTICE:** Changes or modifications not expressly approved by Motorola Solutions may void the users authority, as authorized by the FCC, to operate this device and should not be made. See 47 CFR Part 15.21. Information to the user. The user manual or instruction manual for an intentional or unintentional radiator shall caution the user that changes or modifications not expressly approved by the party responsible for compliance could void the user's authority to operate the equipment.

This device complies with Part 15 of the FCC Rules. Operation is subject to the following two conditions: (1) This device may not cause harmful interference, and (2) this device must accept any interference received, including interference that may cause undesired operation. See 47 CFR Part. 15.19(3).

This device has been tested and found to comply with the limits of Part 15.15 of the FCC rules. Parties responsible for equipment compliance should note that the limits specified in this part will not prevent harmful interference under all circumstances.

This equipment has been tested and found to comply with the limits for a Class B digital device, pursuant to part 15 of the FCC Rules. See Part 15.105b These limits are designed to provide reasonable protection against harmful interference in a residential installation. This equipment generates, uses, and can radiate radio frequency energy and, if not installed and used in accordance with the instructions, may cause harmful interference to radio communications.

However, there is no guarantee that interference will not occur in a particular installation. If this equipment does cause harmful interference to radio or television reception, which can be determined by turning the equipment off and on, the user is encouraged to try to correct the interference by one or more of the following measures:

- Reorient or relocate the receiving antenna.
- Increase the separation between the equipment and receiver.
- Connect the equipment into an outlet on a circuit different from that to which the receiver is connected.
- Consult the dealer or an experienced radio or TV technician for help.

### **Industry Canada (IC) Statements:**

This Class B digital apparatus complies with ICES-003 and Radio Standards Specification (RSS) 210. This product also complies with CAN ICES-3 (B)/NMB-3 (B).



**NOTICE:**

If you are purchasing the Bluetooth Option Board for the first time and your radios are FM approved, send the radios back to the service center to keep the certification.

If you have already purchased the radio with the Bluetooth Option Board as part of the tanapa and you need to replace (repair) the option board, you can send the radio to any Motorola Solutions FM audited.

# Important Safety Information

## RF Energy Exposure and Product Safety Guide for Portable Two-Way Radios

**CAUTION:**

**This radio is restricted to Occupational use only.**

Before using the radio, read the RF Energy Exposure and Product Safety Guide for Portable Two-Way Radios which contains important operating instructions for safe usage and RF energy awareness and control for Compliance with applicable standards and Regulations.

For a list of Motorola Solutions-approved antennas, batteries, and other accessories, visit the following website:

<http://www.motorolasolutions.com>

*Under Industry Canada regulations, this radio transmitter may only operate using an antenna of a type and maximum (or lesser) gain approved for the transmitter by Industry Canada. To reduce potential radio interference to other users, the antenna type and its gain should be so chosen that the equivalent isotropically radiated power (e.i.r.p.) is not more than that necessary for successful communication.*

*This radio transmitter is approved by Industry Canada to operate with a Motorola Solutions-approved antenna with the maximum permissible gain and required antenna impedance for each antenna type indicated. Antenna types not included in this list, having a gain greater than the maximum gain indicated for that type, are strictly prohibited for use with this device.*

# Notice to Users (FCC and Industry Canada)

This device complies with Part 15 of the FCC rules and Industry Canada's license-exempt RSS's per the following conditions:

- This device may not cause harmful interference.
- This device must accept any interference received, including interference that may cause undesired operation.
- Changes or modifications made to this device, not expressly approved by Motorola Solutions, could void the authority of the user to operate this equipment.

# Software Version

All the features described in the following sections are supported by the software version **R20.60.00** or later.

Check with your dealer or system administrator for more details of all the supported features.

# Computer Software Copyrights

The Motorola Solutions products described in this manual may include copyrighted Motorola Solutions computer programs stored in semiconductor memories or other media.

Laws in the United States and other countries preserve for Motorola Solutions certain exclusive rights for copyrighted computer programs including, but not limited to, the exclusive right to copy or reproduce in any form the copyrighted computer program. Accordingly, any copyrighted Motorola Solutions computer programs contained in the Motorola Solutions products described in this manual may not be copied, reproduced, modified, reverse-engineered, or distributed in any manner without the express written permission of Motorola Solutions. Furthermore, the purchase of Motorola Solutions products shall not be deemed to grant either directly or by implication, estoppel, or otherwise, any license under the copyrights, patents, or patent applications of Motorola Solutions, except for the normal non-exclusive license to use that arises by operation of law in the sale of a product.

# Documentation Copyrights

No duplication or distribution of this document or any portion thereof shall take place without the express written permission of Motorola Solutions.

No part of this manual may be reproduced, distributed, or transmitted in any form or by any means, electronic or mechanical, for any purpose without the express written permission of Motorola Solutions.

# Disclaimer

The information in this document is carefully examined, and is believed to be entirely reliable. However, no responsibility is assumed for inaccuracies.

Furthermore, Motorola Solutions reserves the right to make changes to any products herein to improve readability, function, or design. Motorola Solutions does not assume any liability arising out of the applications or use of any product or circuit described herein; nor does it cover any license under its patent rights, nor the rights of others.

# Read Me First

This User Guide covers the basic operation of the radio. However, your dealer or system administrator may have customized your radio for your specific needs. Check with your dealer or system administrator for more information.

If you attempt to use features which are mutually exclusive, one or more of the following occurs:

- A negative tone sounds.
- The radio displays `Feature not allowed`.

## Notations Used in This Manual

Throughout the text in this publication, you will notice the use of **Warning**, **Caution**, and **Notice**. These notations are used to emphasize that safety hazards exist, and the care that must be taken or observed.



**WARNING:** An operational procedure, practice, or condition and so on, which may result in injury or death if not carefully observed.



**CAUTION:** An operational procedure, practice, or condition and so on, which may result in damage to the equipment if not carefully observed.



**NOTICE:** An operational procedure, practice, or condition and so on, which is essential to emphasize.

## Radio Maintenance

This chapter covers the radio and battery care.

### Radio Care

Proper radio usage and care assures efficient operation and long life for the product.

The following are recommendations and warnings when using the radio.





**CAUTION:**

- Your radio casing has a vent port that allows for pressure equalization in the radio. Never poke this vent with any objects, such as needles, tweezers, or screwdrivers. This could create leak paths into the radio and the radio submergibility will be lost.

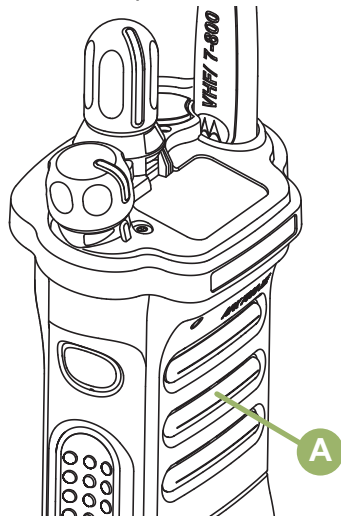

- Your radio is designed to be submerged to a maximum depth of 6 feet, with a maximum submersion time of 2 hours. Exceeding either maximum limit may result in damage to the radio.
- Elastomer seals used in portable radios can age with time and environmental exposure. Therefore, Motorola Solutions recommends that radios be checked annually as a preventive measure in order to assure the waterseal integrity of the radio. Motorola Solutions details the disassembly, test, and reassembly procedures along with necessary test equipment in the *Service Manual*.
- If the radio battery contact is exposed to water without the battery attached, dry and clean the radio battery contacts before attaching a battery to the radio. Turn the radio over with the battery contact facing down and shake the radio so any trapped water can escape. The battery contacts must be dry before attaching a battery or a short circuit of the contacts could occur.
- Avoid subjecting the radio to an excess of liquids. Do not submerge the radio unless it is ruggedized.
- Accessory connector cover must be attached to the radio side accessory connector if an accessory is not attached to the radio.
- If the radio is submerged or exposed to a high force water spray, such as from a hose, remove the side accessory connector or accessory connector cover immediately and check to make sure no water was forced into the accessory connector/radio interface. Rinse and dry the area and re-attach the accessory or accessory connector cover if leakage occurs.
- If the radio is exposed to a corrosive environment, such as salt water or corrosive gases or liquids, rinse and clean the radio immediately to prevent damage to radio materials, especially plated surfaces. Refer to [Cleaning Your Radio on page 18](#) for detailed instructions. Remove the battery and the antenna before cleaning.
- If the radio has been submerged in water, shake the radio well so that any water that may be trapped inside the speaker grille and microphone port can be removed. Otherwise, the water will decrease the audio quality of the radio.
- Do **not** disassemble the radio. This could damage radio seals and result in leak paths into the radio. Any radio maintenance should be performed only by a qualified radio technician.

- Underwriter Laboratory (UL) certified radios should only be opened and serviced by UL approved service centers. Opening or repairing at unauthorized locations will invalidate the radio's hazardous location rating.
- Do **not** pound, drop, or throw the radio unnecessarily.
- When charging the radio using a wall mounted charger, the radio must be turned off. Otherwise, the Man Down Alert and Emergency may be accidentally triggered.

## Cleaning Your Radio



**CAUTION:** Do **not** use solvents to clean your radio as most chemicals may permanently damage the radio housing and textures.  
Do **not** submerge the radio in the detergent solution.

To clean the external surfaces of your radio, follow the procedure described next.

### Procedure:

- 1 Combine one teaspoon of mild dishwashing detergent to one gallon of water (0.5% solution).
- 2 Apply the solution sparingly with a stiff, non-metallic, shortbristled brush, making sure that excess detergent does not get entrapped near the connectors, controls, or crevices. Rinse and then dry the radio thoroughly with a soft, lint-free cloth.
- 3 Clean battery contacts with a lint-free cloth to remove dirt or grease.

## Radio Service and Repair

Proper repair and maintenance procedures ensures efficient operation and long life for this product. A Motorola Solutions maintenance agreement will provide expert service to keep this and all other communication equipment in perfect operating condition.

A nationwide service organization is provided by Motorola Solutions to support maintenance services. Through its maintenance and installation program, Motorola Solutions makes the finest service available to those desiring reliable, continuous communications on a contract basis.

For a contract service agreement, contact your nearest Motorola Solutions service or sales representative, or an authorized Motorola Solutions dealer.

## Cleaning the External Surface of the Radio

### When and where to use:



**CAUTION:** Do **not** use solvents to clean your radio. Spirits may permanently damage the radio housing.  
Do **not** submerge the radio in detergent solution.

### Procedure:

- 1 Combine one teaspoon of mild dishwashing detergent to one gallon of water (0.5% solution).
- 2 Apply the solution sparingly with a stiff, non-metallic, short-bristled brush, making sure excess detergent does not get entrapped near the connectors, controls or crevices.
- 3 Dry the radio thoroughly with a soft, lint-free cloth.

## Battery Care

This section provides information on the battery charge status, battery recycling, and disposal.

### Battery Charge Status

Your radio indicates the battery charge status through:

- LED and sounds
- The fuel gauge icon on the display





### LED and Sounds

When your battery is low:

- the LED blinks red when the **PTT** button is pressed.
- you hear a low-battery “chirp” (short, high-pitched tone).

### Fuel Gauge Icons

The fuel gauge icon indicates the battery level of your radio. A blinking fuel gauge icon () is displayed only when the battery voltage drops to low level. In this case, replace the battery with a fully charged one.

Gauge	Battery Charge
	76% to 100% full
	51% to 75%
	26% to 50%
	11% to 25%
	10% or less (at 10%, the gauge begins blinking)

### Battery Recycling and Disposal

In the U.S. and Canada, Motorola Solutions participates in the nationwide Call2Recycle program for battery collection and recycling. Many retailers and dealers participate in this program.

For the location of the drop-off facility closest to you, go to <http://www.call2recycle.org/> or call 1-800-8-BATTERY. This website and telephone number also provide other useful information concerning recycling options for consumers, businesses, and governmental agencies.

## Additional Performance Enhancement

The following performance enhancements are some of the latest creations designed to enhance the security, quality, and efficiency of the radios.

### ASTRO 25 Enhanced Data

ASTRO 25 Enhanced Data is optimized to handle different message sizes and variable update rates from different applications of the radio. Add Enhanced Data to the Integrated Data system with a software installation to improve data channel efficiency and enable denser network traffic.

### Dynamic System Resilience (DSR)

DSR ensures the radio system is seamlessly switched to a backup master site dynamically in case of system failure. DSR also provides additional indication such as failure detection, fault recovery, and redundancy within the system to address to the user in need. Mechanisms related to the Integrated Voice and Data (IV&D) or data centric are all supported by DSR.

### CrossTalk Prevention

This feature prevents crosstalk scenarios from happening, especially when a wideband antenna is used. This feature allows the adjustment of the internal SSI clock rate of the radio. This subsequently reduces the possibility of radio frequency interfering spurs and prevents the issues of crosstalk.

### Encrypted Integrated Data (EID)

EID provides security encryption and authentication of IV&D data bearer service communication between the radio and the Customer Enterprise Network.

### SecureNet

SecureNet allows user to perform secured communications on an Analog or Motorola Data Communication (MDC) channel. The MDC Over-the-Air Rekeying (OTAR) feature will allow users to perform OTAR activities on an MDC channel.

### Over-the-Air Rekeying

The Over-the-Air Rekeying (OTAR) feature allows the dispatcher to remotely reprogram encryption keys in the radio after a rekey request.

#### Single-system OTAR

Single-system OTAR allows a radio to be rekeyed by only one Key Management Facility (KMF) or Key Management Controller (KMC).

#### Multi-system OTAR

Multi-system OTAR allows a radio to be rekeyed by multiple KMFs. After an initial programming, the radio is able to seamlessly move to different secure systems associated to a newly selected channel.



**NOTICE:** This feature must be preprogrammed by a qualified radio technician. Check with your dealer or system administrator for more information.

### P25 Digital Vehicular Repeater System (DVRS)

Motorola Solutions offers an MSI Certified APX compatible, third Party, P25 Digital Vehicular Repeater System (DVRS) that provides low-cost portable radio coverage in areas where only mobile radio coverage is available and portable radio coverage is either intermittent or non-existent.



**NOTICE:** Portable subscriber units enabled in the system for Radio Authentication shall be able to authenticate regardless of whether they are communicating directly on the system or through a DVRS.

## Conventional Talkgroup and Radio Scan Enhancements

A few enhancements have been made to the Conventional Talkgroup at the system. These enhancements improve the Scan feature operation significantly when multiple agencies are using a single conventional radio frequency channel. These enhancements allow users to use Selective Squelch to operate on only the subset of talkgroups that are relevant to the users rather than all talkgroups on the channel. These Scan improvements have been made to eliminate the audio holes that were present and to turn on the busy LED when activity is present on the channel. Mixed Vote Scan and Standard Conventional Scan configurations are supported. Priority Operation is also supported.

Up to 30 different talkgroups can be supported using conventional channels. A maximum of four talkgroups can be supported when Vote Scan channels are being used.

Smart **PTT** is supported with this enhancement as Smart **PTT** prevents users from transmitting while other users are on the channel.



**NOTICE:** User Selectable Talkgroups are not compatible with this Conventional Talkgroup Enhancement.

## What Your Dealer/System Administrator Can Tell You

Check with your dealer or system administrator for the correct radio settings, if the radio is to be operated in extreme temperatures (less than -30 °C or more than +60 °C).

You can consult your dealer or system administrator about the following:

- Is your radio programmed with any preset conventional channels?
- Which buttons have been programmed to access other features?
- What optional accessories may suit your needs?



**NOTICE:** Specifications may vary for different radio models. Check with your dealer or system administrator for more information.

# Preparing Your Radio for Use

This section provides simple instructions to prepare your radio for use.

## Charging the Battery

### Prerequisites:



**WARNING:** To avoid a possible explosion:

- Do **not** replace the battery in any area labeled **hazardous atmosphere**.
- Do **not** discard batteries in a fire.

**When and where to use:** The Motorola Solutions-approved battery shipped with your radio is uncharged. Prior to using a new battery, charge it for a minimum of 16 hours to ensure optimum capacity and performance. For a list of Motorola Solutions-authorized batteries and chargers available for use with your radio, see [Accessories on page 83](#).



**NOTICE:** When charging a battery attached to a radio, turn the radio off to ensure a full charge.

### Procedure:

To charge the battery, place the battery (with or without the radio) in a Motorola Solutions-approved charger.

The LED on the charger indicates the charging progress; see the *Charger User Guide*.

## Attaching the Battery

**Prerequisites:** If your radio is preprogrammed with volatile-key retention, the encryption keys are retained for approximately 30 seconds after battery removal. Check with your dealer or system administrator for more information.

### When and where to use:



**NOTICE:**

User is notified if radio detects non-Motorola Solutions battery upon powering up, charging, or removing from the charger. This feature is applicable for IMPRES and Non-IMPRES battery. When the radio is attached with the non-Motorola Solutions battery, a tone sounds, display shows `Unknown Battery` temporarily and battery indicator is not shown in the radio display. Battery menu screen displays `Unknown Battery` permanently and IMPRES battery information is not shown on the radio display.

### Procedure:

- 1 Slide the battery into the radio frame until the side latches click into place.

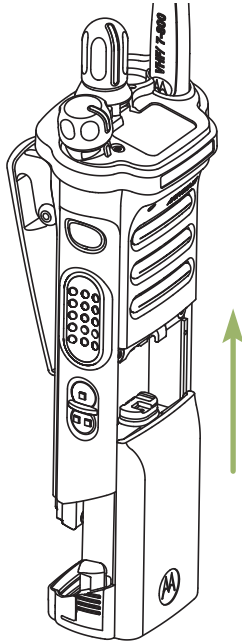

- 2 To remove the battery, turn the radio off. Squeeze the release latches **A** at the bottom of the battery until the battery releases from the radio and remove the battery from the radio.

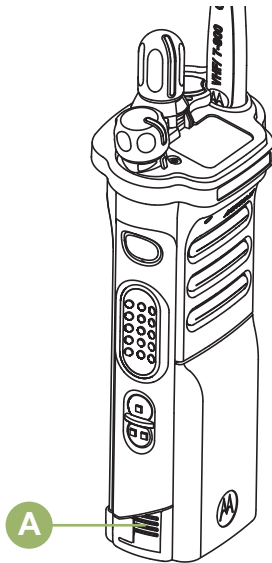

## Attaching the Antenna

**Prerequisites:** Ensure the radio is turned off before attaching the antenna.

**Procedure:**

- 1 Set the antenna in the receptacle.
- 2 Turn the antenna clockwise to attach to the radio.

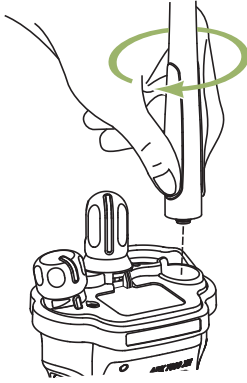

- 3 To remove the antenna, turn the antenna counterclockwise.

 **NOTICE:** When removing the antenna, ensure that the radio is turned off.

## Removing and Attaching the Accessory Connector Cover

**When and where to use:** The accessory connector is on the antenna side of the radio. It is used to connect accessories to the radio.

 **NOTICE:** To prevent damage to the connector, shield it with the connector cover when not in use.

### Procedure:

- 1 To remove the accessory connector cover, rotate the thumbscrew **B** counterclockwise until it disengages from the radio.

 **NOTICE:** If the thumbscrew is too tight, use an Allen wrench at **C** to loosen it first.

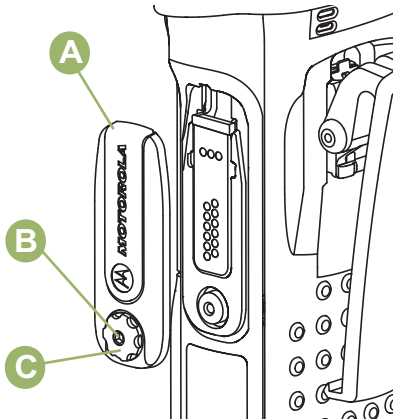

- 2 Rotate and lift the connector cover to disengage it from the radio.
- 3 To attach the accessory connector cover, insert the hooked end **A** of the cover into the slot above the connector.
- 4 Press the top of the cover downward to seat it in the slot.
- 5 Once in place, tighten by rotating the thumbscrew **B** clockwise by hand.



## Attaching the Belt Clip

### Procedure:

- 1 Align the grooves of the belt clip with those of the radio and press upward until you hear a click to attach the belt clip.

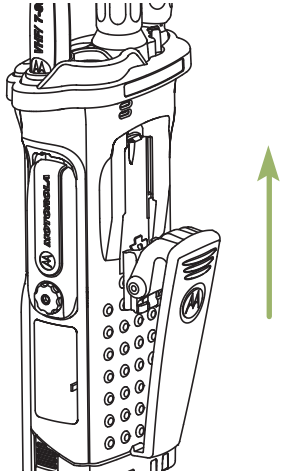

- 2 Use a flat-bladed object to press the belt clip tab away from the radio. Then, slide the clip downward and away from the radio to remove the clip.



## Turning On the Radio

### Procedure:

- 1 Rotate the **On/Off/Volume Control Knob** clockwise until you hear a click.

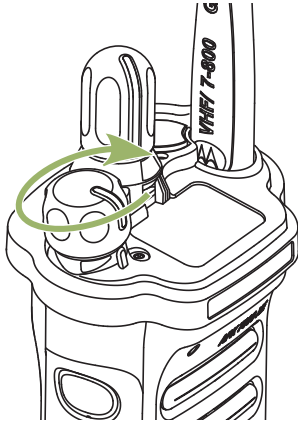

- If the power-up test is successful, the display shows `SELFTEST` momentarily, followed by the Home screen and the Codeplug Alias.
- If the power-up test is unsuccessful, you see `Error XX/YY` (`XX/YY` is an alphanumeric code).



**NOTICE:**

If the radio fails to power-up after repeating a few times, record the `Error XX/YY` code and contact your dealer.

Codeplug Alias feature is enabled through Customer Programming Software (CPS) configuration to display the codeplug alias as a temporary text during power on.

- 2 To turn off the radio, rotate the **On/Off/Volume Control Knob** counterclockwise until you hear a click.

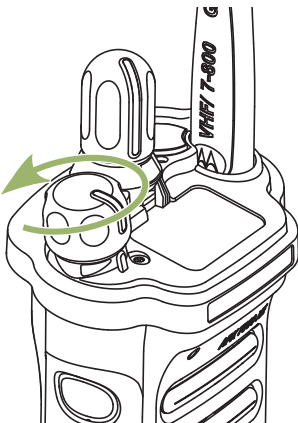

## Adjusting the Volume

**Prerequisites:** Ensure the radio is powered on and the main speaker is pointed towards you for increased loudness and intelligibility, especially in areas with loud background noises.

**Procedure:**

- 1 To increase the volume, rotate the **On/Off/Volume Control Knob** Ⓐ clockwise.

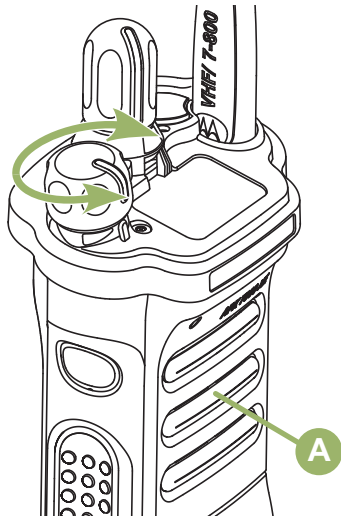

- 2 To decrease the volume, rotate this knob counterclockwise.

# Radio Controls

This chapter explains the buttons and functions to control the radio.

## Radio Parts and Controls

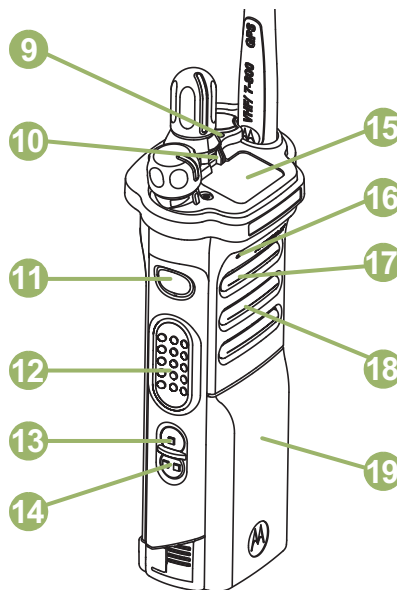
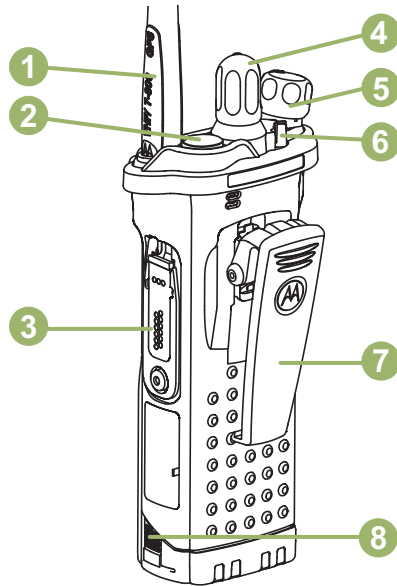

1	Antenna
2	Top (Orange) Button <sup>1</sup>
3	Accessory Connector
4	16-Position Select Knob <sup>1</sup>

<sup>1</sup> These radio controls/buttons are programmable.

5	On/Off/Volume Control Knob
6	3–Position A/B/C Switch <sup>1</sup>
7	Belt Clip
8	Battery Latch
9	LED
10	2–Position Concentric Switch <sup>1</sup>
11	Top Side (Select) Button <sup>1</sup>
12	Push-to-Talk (PTT) Button
13	Side Button 1 <sup>1</sup>
14	Side Button 2 <sup>1</sup>
15	Top Display
16	Bluetooth Pairing Location Indicator
17	Microphone
18	Main Speaker
19	Battery

## Programmable Features

Any reference in this manual to controls that are preprogrammed means that a qualified radio technician must use the radio programming software to assign a feature to a control.

Your dealer can program the programmable buttons as shortcuts to radio functions or preset channels/groups depending on the duration of a button press. Some functions can also be programmed to the radio switches.

## Assignable Radio Functions

### Bluetooth On/Off

Allows you to turn on/off the Bluetooth.

### Bluetooth Audio Reroute

Allows you to toggle the audio route between the radio speaker or Remote Speaker Microphone and the Bluetooth headset.

### Bluetooth Headset PTT

Keys up the Bluetooth Headset microphone.

### Bluetooth Clear All Pairing

Allows you to clear all pairing information for Bluetooth by pressing and holding the Bluetooth On/Off Button.

### Bluetooth Inquiry On/Off

Enables the Bluetooth Search feature.

### Bluetooth Discoverable On/Off

Enables Bluetooth visibility pressing and holding the Bluetooth Inquiry On/Off Button.

### Call Response

Allows you to answer a private call.

### Dynamic Priority (Conventional Only)

Allows any channel in a Scan List (except for the Priority-One channel) to temporarily replace the Priority-Two channel.

**Emergency**

Depending on the programming, initiates or cancels an emergency alarm or call.

**Internet Protocol Address**

Displays the Internet Protocol (IP) address, device name, and status of the radio.

**Man Down Clear**

Clears the Man Down mode alarm that is triggered when your radio achieves or passes a tilt angle threshold or a combination of the angle threshold and a motion sensitivity level.

**Monitor (Conventional Only)**

Monitors a selected channel for all radio traffic until the function is disabled.

**Nuisance Delete**

Temporarily removes an unwanted channel, except for priority channels or the designated transmit channel from the scan list.

**One Touch 1–4**

Launches a specific feature with. You can set up as many as four separately programmed buttons for four different features.

**Private Line Defeat (Conventional Only)**

Overrides any coded squelch (DPL or PL) that is preprogrammed to a channel.

**Priority Dispatch**

Allows you to call the dispatcher on a different talkgroup.

**Rekey Request**

Notifies the dispatcher that a new encryption key is needed.

**Repeater Access Button (RAB) (Conventional Only)**

Allows you to manually send a repeater access codeword.

**Reprogram Request (Trunking Only)**

Notifies the dispatcher that a new dynamic regrouping assignment is needed.

**Request-To-Talk (Conventional Only)**

Notifies the dispatcher that you want to send a voice call.

**Scan**

Toggles scan on or off.

**Scan List Programming**

Selects the scan list for editing (by pressing and holding the Scan button).

**Secure Transmission Select (Conventional and Trunking)**

Toggles the Secure Transmission On or Off when the Secure/Clear Strapping field is set to *Select* for the current channel and when the radio is model/option capable.

**Site Display/Search (Trunking Only)**

Displays the current site ID and RSSI value; performs site search for Automatic Multiple Site Select (AMSS) or SmartZone operation.

**Site Lock/Unlock (Trunking Only)**

Locks onto a specific site.

**Talkaround/Direct (Conventional Only)**

Toggles between using a repeater or communicating directly with another radio.

**Basic Zone Bank**

Provides access from up to six zones by toggling between two banks of three zones, one group of three (A, B, and C) to a second group of three zones (D, E, and F).

**Enhanced Zone Bank**

Provides access from up to 75 zones by toggling between 25 banks (A, B, ... X or Y) of three zones.

## Assignable Settings or Utility Functions

### Controls Lock

Locks or unlocks the programmable buttons, switches, or rotary knobs.

### Light/Flip

Press the button to toggle the display backlight on and off; press and hold the button to reverse the content of the top display.

### TX Power Level

Toggles the transmit power level between high and low.

### Voice Announcement

Audibly indicates the current feature mode, zone, or channel that you have been assigned to.

### Voice Mute

Toggles the voice transmission between mute and unmute.

### Volume Set Tone

Sets the volume set tone.

## Accessing the Preprogrammed Functions

**When and where to use:** You can access various radio functions through a short or long press of the relevant programmable buttons.

## Push-To-Talk (PTT) Button

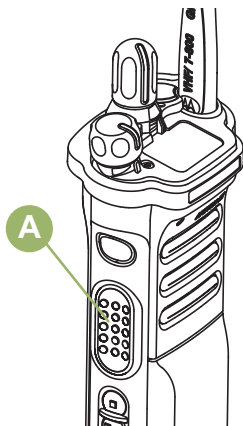

The **PTT** button **A** on the side of the radio serves two basic purposes:











- While a call is in progress, the **PTT** button allows the radio to transmit to other radios in the call. Press and hold down **PTT** button to talk. Release the **PTT** button to listen. The microphone is activated when the **PTT** button is pressed.
- While a call is not in progress, the **PTT** button is used to make a new call. See [Methods to Make a Radio Call on page 41](#) for more information.

# Status Indicators

This section explains the status indicators of the radio.



## Status Icons

Selected icons are also shown on the first row of the 112 x 32 pixel top monochrome display screen of your radio.

	<p><b>Receiving</b>          Radio is receiving a call or data.</p>
	<p><b>Transmitting</b>          Radio is transmitting a call or data.</p>
	<p><b>Battery</b>          For IMPRES battery operation only – the icon shown indicates the charge remaining in the battery.          For all battery operation – the icon blinks when the battery is low.</p>
	<p><b>Received Signal Strength Indicator (RSSI)</b>          The number of bars displayed represents the received signal strength for the current site (trunking only) The more stripes in the icon, the stronger the signal.</p>
	<p><b>Roaming</b>          The radio has roamed to and is currently registered to a foreign system.</p>
	<p><b>Direct</b>  <b>On</b>          Radio is currently configured for direct radio-to-radio communication (during conventional operation only).  <b>Off</b>          Radio is connected with other radios through a repeater.</p>
	<p><b>Monitor (Carrier Squelch)</b>          Selected channel is being monitored (during conventional operation only).</p>
	<p><b>Power Level</b>  <b>L</b>          Radio is set at Low power.  <b>H</b>          Radio is set at High power.</p>
	<p><b>Scan</b>          Radio is scanning a scan list.</p>
	<p><b>Priority Channel Scan</b>  <b>Blinking dot</b>          Radio detects activity on channel designated as Priority-One.  <b>Steady dot</b>          Radio detects activity on channel designated as Priority-Two.</p>



	<p><b>View/Program Mode</b> Radio is in the view or program mode.</p> <p><b>On steady</b> View mode</p> <p><b>Blinking</b> Program mode</p>
	<p><b>Vote Scan Enabled</b> The vote scan feature is enabled.</p>
	<p><b>Basic Zone Bank 1</b></p> <p><b>A</b> Radio is in Zone 1.</p> <p><b>B</b> Radio is in Zone 2.</p> <p><b>C</b> Radio is in Zone 3.</p>
	<p><b>Basic Zone Bank 2</b></p> <p><b>D</b> Radio is in Zone 4.</p> <p><b>E</b> Radio is in Zone 5.</p> <p><b>F</b> Radio is in Zone 6.</p>
	<p><b>Enhanced Zone Bank</b></p> <p><b>A</b> Contains Zone 1, Zone 2, and Zone 3,</p> <p><b>B</b> Contains Zone 4, Zone 5, and Zone 6,</p> <p><b>C</b> Contains Zone 7, Zone 8, and Zone 9, until</p> <p><b>X</b> Contains Zone 70, Zone 71, and Zone 72,</p> <p><b>Y</b> Contains Zone 73, Zone 74, and Zone 75.</p>
	<p><b>Secure Operation</b></p> <p><b>On</b> Secure operation.</p> <p><b>Off</b> Clear operation.</p> <p><b>Blinking</b> Receiving an encrypted voice call.</p>
	<p><b>GPS Signal</b></p>

	<b>On</b> Feature is enabled and signal is available.
	<b>Off</b> Feature is disabled.
	<b>Blinking</b> Feature is enabled, but no signal is available.
	<b>Bluetooth On</b> Bluetooth is on and ready for Bluetooth connection.
	<b>Bluetooth Connected</b> Bluetooth is currently connected to the external Bluetooth device.

## LED Indicator

The LED indicator  shows the operational status of your radio.

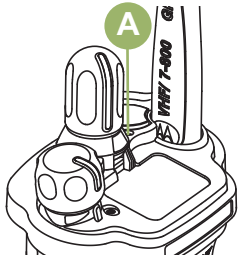

### Solid red

Radio is transmitting.

### Blinking red

Radio is transmitting at low battery condition.

### Double blinking red

Radio is in Emergency Mode.

### Rapidly blinking red

Radio has failed the self test upon powering up or encountered a fatal error.

### Solid yellow (Conventional Only)

Channel is busy.

### Blinking yellow

Radio is receiving a secured transmission.

### Solid green

Radio is powering up, or is on a non-priority channel while in the Scan List Programming mode.

### Blinking green

Radio is receiving an individual or telephone call, or is on a Priority-Two channel while in the Scan List Programming mode.

### Rapidly blinking green

Radio is on a Priority-One channel while in the Scan List Programming mode.

### Solid green and short blinking blue with long interval

Radio is reading or upgrading by CPS.

### Blinking blue 3 times

Bluetooth is powering on or off.

**Slow blinking blue**

Radio is waiting to be paired when no device is connected with radio in Bluetooth.

**Blinking blue at heartbeat pace**

Radio is connected with at least a device in Bluetooth link.

**Solid blue for 2 seconds**

Bluetooth device is connected.

Bluetooth device is disconnected.

**Blinking blue**

Radio is clearing Bluetooth pairing information.

**Rapid blinking blue for 2 seconds**

Radio fails to connect or disconnect from a device.

**Solid blue**

Radio is powering up with Option Board error.



**NOTICE:** No LED indication when the radio receives a clear (non-secured) transmission in trunking Mode. LED indication can be preprogrammed by qualified technician to be permanently disabled. Consult your dealer for further details if you want to disable it.

## Intelligent Lighting Indicators

This feature temporarily changes the backlight of the top display screen to help signal that a radio event has occurred.



**NOTICE:** This feature must be preprogrammed by a qualified radio technician.

Backlight and Bar Color	Notification	When
Orange	Emergency Alerts	The radio initiates an emergency alarm or call.
		The radio receives an emergency alarm or call.
Red	Critical Alerts	The radio battery is low.
		The radio is out of range.
		The radio enters Failsoft mode.
		The radio is unable to establish a full connection with the system.
Red	Critical Alerts	The radio is unable to authenticate or register with the system.
		The radio is out of range.
		The radio enters Failsoft mode.
		The radio is unable to establish a full connection with the system.
Green	Call Alerts	The radio is unable to authenticate or register with the system.
		The radio receives a private call.
		The radio receives a phone call.
		The radio receives a call alert.

Backlight and Bar Color	Notification	When
		The radio receives a selective call.
		The radio enters Geofence.

## Alert Tones

Your radio uses alert tones to inform you of the condition of your radio. The following table lists these tones and when they occur.

You Hear	Tone Name	Heard
<b>Short, Low-Pitched Tone</b>	<b>Radio Self Test Fail</b>	When radio fails its power-up self test.
	<b>Reject</b>	When an unauthorized request is made.
	<b>Time-Out Timer Warning</b>	Four seconds before time out.
	<b>No ACK Received</b>	When radio fails to receive an acknowledgment.
	<b>Individual Call Warning Tone</b>	When radio is in an individual call for greater than six seconds without any activity.
	<b>Man Down Entry</b>	When radio initiates Man Down mode.
<b>Long, Low-Pitched Tone</b>	<b>Time-Out Timer Timed Out</b>	After time out.
	<b>Talk Prohibit/PTT Inhibit</b>	(When <b>PTT</b> button is pressed) transmissions are not allowed.
	<b>Lack of Voice PTT Time out</b>	When the radio ends your call after it detected there are lack of voice for five seconds after the PTT is pressed and hold. Your radio ends the call to enable your radio to receive calls from other radio users.
	<b>Out of Range</b>	(When <b>PTT</b> button is pressed) the radio is out of range of the system.
	<b>Invalid Mode</b>	When radio is on an unpreprogrammed channel.
<b>A Group of Low-Pitched Tones</b>	<b>Busy</b>	When system is busy.
<b>Short, Medium-Pitched Tone</b>	<b>Valid Key-Press</b>	When a correct key is pressed.
	<b>Radio Self Test Pass</b>	When radio passes its power-up self test.
	<b>Clear Voice</b>	At beginning of a non-coded communication.
	<b>Priority Channel Received</b>	When activity on a priority channel is received.
	<b>Emergency Alarm/Call Entry</b>	When entering the emergency state.
	<b>Central Echo</b>	When central controller has received a request from a radio.

<b>You Hear</b>	<b>Tone Name</b>	<b>Heard</b>
<b>Long, Medium-Pitched Tone</b>	<b>Volume Set</b>	When volume is changed on a quiet channel.
	<b>Emergency Exit</b>	When exiting the emergency state.
<b>A Group of Medium-Pitched Tones</b>	<b>Failsoft</b>	When the trunking system fails.
	<b>Automatic Call Back</b>	When voice channel is available from previous request.
	<b>Keyfail</b>	When encryption key has been lost.
	<b>Console Acknowledge</b>	When status, emergency alarm, or reprogram request ACK is received.
	<b>Received Individual Call</b>	When Call Alert or Private Call is received.
	<b>Site Trunking</b>	When a SmartZone trunking system fails.
<b>Short, High-Pitched Tone (Chirp)</b>	<b>Low-Battery Chirp</b>	When battery is below preset threshold value.
<b>Two High-Pitched Tones</b>	<b>GPS Fails</b>	When the GPS fails or loses signal.
<b>Ringing</b>	<b>Phone Call Received</b>	When a land-to-mobile phone call is received.
<b>Gurgle</b>	<b>Dynamic Regrouping</b>	(When <b>PTT</b> button is pressed) a dynamic ID has been received.
	<b>Talk Permit</b>	(When <b>PTT</b> button is pressed) is verifying with the system for accepting its transmissions.
<b>Unique, Low-Pitched Chirp</b>	<b>New Message</b>	When a new message is received.
<b>Unique, High-Pitched Chirp</b>	<b>Priority Status</b>	When a priority message is received.
<b>Incremental-Pitched Tone</b>	<b>Bluetooth Paired</b>	When Bluetooth accessory is paired with the radio.
	<b>Bluetooth Connected</b>	When Bluetooth accessory is connected to the radio.
<b>Decremental-Pitched Tone</b>	<b>Bluetooth Unpaired</b>	When Bluetooth accessory is unpaired from the radio.
	<b>Bluetooth Disconnected</b>	When Bluetooth accessory is disconnected from the radio.
<b>A Group of Very High-Pitched Tones</b>	<b>Man Down Continuous Tone</b>	When radio is in Man Down mode and prepares to transmit Emergency Alarm when the timer of this alarm ends.
	<b>Critical Man Down Continuous Tone</b>	When radio is in Man Down Enhanced mode and prepares to transmit Emergency Alarm when the timer of this alarm ends.
<b>Unique Low-High Tone</b>	<b>Enhanced Zone Bank Up</b>	When <b>EZB Up</b> button is pressed to scroll the Enhance Zone Bank up.

You Hear	Tone Name	Heard
Unique High-Low Tone	Enhanced Zone Bank Down	When <b>EZB Down</b> button is pressed to scroll the Enhance Zone Bank down.

## Display Color Change On Channel

This feature provides visual channel identification where users are able to have a quick visual recognition of being on a particular channel.

Your radio must be preprogrammed to allow you to use this feature.

When changing channels, the radio backlight on top display and accessories (DRSM) changes to the preprogrammed color.

The backlight on top display changes to white and if connected to DRSM, the DRSM backlight changes to white for the following scenarios:

- When changing to or powering up on an invalid channels such as unprogrammed channels, receiver frequency error channel and blank channels

For hard key zeroize, key loading, and scan list programming, the backlight follows the home channel backlight color.

## HAZLOC Battery Type Detection

This feature alerts the user when there is a HAZLOC certification mismatch between the radio and the battery. This feature supports IMPRES batteries only.

During power up, if there is a mismatch, the following scenarios occurs:

- The radio repetitively displays *Wrong Battery* with red intelligent backlight
- The radio Voice Announcement announces the preprogrammed Wrong Battery
- The Battery icon blinks continuously
- A repetitive tone sounds
- LED blinks RED continuously



**NOTICE:**

The radio does not display any indication when the radio is connected to the charger, when the radio and battery match, or when the radio certification type is configured as "None" in Customer Programming Software (CPS).

This feature is enabled through CPS configuration. Check with your dealer or system administrator for more information.

# General Radio Operation

This chapter explains the general radio operations of your radio.

## 1.1

### Selecting a Zone

**Prerequisites:** Your radio must be preprogrammed for you to use this feature.

**When and where to use:** A zone is a group of channels.

**Procedure:**

- Select a zone using the preprogrammed **Zone (3-Position A/B/C)** switch:
  - a. Move the preprogrammed **Zone (3-Position A/B/C)** switch to the position of the required zone.  
If the zone number entered is unprogrammed, the display shows `INVALID`. Repeat this step.
  - b. Press the **PTT** button to transmit on the displayed zone channel.

## 1.2

### Selecting a Radio Channel

**When and where to use:** A channel is a group of radio characteristics, such as transmit/receive frequency pairs.

**Procedure:**

- Select a channel using the preprogrammed **16-Position Select Knob** to the desired channel.
  - a. Rotate the preprogrammed **16-Position Select Knob** to the desired channel.
  - b. Press the **PTT** button to transmit on the displayed zone channel.

## 1.3

### Receiving and Responding to a Radio Call

Once you have selected the required channel and/or zone, you can proceed to receive and respond to calls.

The radio shows different indicators based on the system the radio is configured.

- The LED lights up solid red while the radio is transmitting.
- In conventional mode, the LED lights up solid yellow when the radio is receiving a transmission.
- In trunking mode, there is no LED indication when the radio receives a transmission.
- If the radio is receiving a secure transmission, the LED blinks yellow.

#### 1.3.1

### Receiving and Responding to a Talkgroup Call

**Prerequisites:** To receive a call from a group of users, your radio must be configured as part of that talkgroup.

**When and where to use:** When you receive a talkgroup call (while on the Home screen) the radio displays the following depending on the system your radio is configured to:

- For ASTRO Conventional system, the LED lights up solid yellow. The display shows the talkgroup alias or ID, and the caller alias or ID.
- For Trunking system, the display shows the caller alias or ID.

**Procedure:**

- 1 Hold the radio vertically 1 to 2 inches (2.5 to 5.0 cm) from your mouth.
- 2 Press the **PTT** button to respond to the call.  
The LED lights up solid red.
- 3 Release the **PTT** button to listen.

See also [Making a Talkgroup Call on page 41](#) for details on making a Talkgroup Call.

1.3.2

## Receiving and Responding to a Private Call (Trunking Only)

**When and where to use:**

A Private Call is a call from one individual radio to another.

The one-to-one call between the two radios are not heard by the others in the current talkgroup. The calling radio automatically verifies that the receiving radio is active on the system and can display the caller ID.



**NOTICE:** With the inactivity timer enabled (optional), when there is no response from the receiving radio, the calling radio exits the call with Menu Inactive Exit tone after the timer expires.

When you receive a Private Call, you hear two alert tones and the LED blinks green. The display shows `CALL RCV`, alternating with the caller alias (name) or ID (number).

**Procedure:**

- 1 Press the **Call Response** button within 20 seconds after the call indicators begin.
- 2 Press and hold the **PTT** button to talk. Release the **PTT** button to listen.
- 3 Press the **Call Response** button to hang up and return to the Home screen.

1.3.3

## Receiving and Responding to a Telephone Call (Trunking Only)

**When and where to use:**

This feature allows you to receive calls similar to standard phone calls from a landline phone.



**NOTICE:** With the inactivity timer enabled (optional), if there is no response to the call after the timer expires, your radio exits the call with Menu Inactive Exit tone.

When you receive a Telephone Call, you hear a telephone-type ringing and the LED blinks green. The backlight of the screen turns green and the display shows `PHN CALL` and the call received icon blinks.

**Procedure:**

- 1 Press the **Call Response** button within 20 seconds after the call indicators begin.
- 2 Press and hold the **PTT** button to talk. Release the **PTT** button to listen.



- 3 Press the **Call Response** button to hang up and return to the Home screen.

You cannot initiate a Telephone Call.

#### 1.4

### Methods to Make a Radio Call

You can select a zone, channel, subscriber ID, or talkgroup by using:

- The preprogrammed **Zone** switch.
- The **16-Position Select Channel Knob**.
- A preprogrammed **One Touch Call** button.

#### 1.4.1

### Making a Talkgroup Call

**Prerequisites:** To make a call to a group of users, your radio must be configured as part of that talkgroup.

**Procedure:**

- 1 Turn the **16-Position Select Channel Knob** to select the channel with the desired talkgroup.
- 2 Hold the radio vertically 1 to 2 inches (2.5 to 5.0 cm) from your mouth.
- 3 Press the **PTT** button to make the call.

The radio shows different indicators based on the system the radio is configured.

- For ASTRO Conventional system, the LED lights up solid red. The display shows the talkgroup alias or ID.
- For Trunking system, the LED lights up solid red.

- 4 Speak clearly into the microphone.
- 5 Release the **PTT** button to listen.

#### 1.4.2

### Making a Private Call (Trunking Only)

**Prerequisites:** Your radio must be preprogrammed for you to use this feature.

**Procedure:**

- 1 Press the preprogrammed **Quick Access (One-Touch) Private Call** button to dial the preprogrammed ID.

The display shows the preprogrammed ID.

- 2 Press the **PTT** button to initiate the Private Call.

- 3 Hold the radio vertically 1 to 2 inches (2.5 to 5.0 cm) from your mouth.

When you are connected, the display shows the ID of the target radio. If no acknowledgment is received, the display shows **NO ACK**.

- 4 Press and hold the **PTT** button to talk. Release the **PTT** button to listen.

- 5 Press the preprogrammed **Quick Access (One-Touch) Private Call** button to return to the home screen.

### 1.4.3

## Making an Enhanced Private Call (Trunking Only)

**Prerequisites:** Your radio must be preprogrammed to allow you to use this feature.

**Procedure:**

- 1 Press the preprogrammed **Quick Access (One-Touch) Private Call** button to dial the preprogrammed ID and initiate the Enhanced Private Call.

The display shows the preprogrammed ID and a ringing tone sounds.

- 2 Hold the radio vertically 1 to 2 inches (2.5 to 5.0 cm) from your mouth.

When you are connected, the display shows the ID of the target radio and the ringing tone stops.

If no acknowledgment is received, the display shows **NO ACK**.

If the target radio does not respond before the time out, the display shows **NO ANSR**.

- 3 Press and hold the **PTT** button to talk. Release the **PTT** button to listen.
- 4 Press the preprogrammed **Quick Access (One-Touch) Private Call** button to return to the home screen.

### 1.5

## Switching Between Repeater or Direct Operation Button

**When and where to use:**

The Repeater Operation increases the radio coverage area by connecting with other radios through a repeater. The transmit and receive frequencies are different.

The Direct or “talkaround operation” allows you to bypass the repeater and connect directly to another radio. The transmit and receive frequencies are the same.

**Procedure:**

Press the preprogrammed **Repeater/Direct** switch to toggle between talkaround and repeater modes.

The display shows **RPTR MOD** if the radio is currently in Repeater mode.

The display shows **DIR MODE** and the Talkaround icon if the radio is currently in Direct mode (during conventional operation only).

### 1.6

## Monitor Feature

The monitor feature is used to make sure that a channel is clear before transmitting.

The lack of static on a digital channel when the users switch from analog to digital radios is not an indication that the radio is malfunctioning.

Digital technology quiets the transmission by removing the noise from the signal and allows only the clear voice or data information to be heard.

### 1.6.1

## Monitoring a Channel

### Procedure:

- Monitoring a Channel using the **Monitor** and **Volume Set** button.
  - a. Press the preprogrammed **Monitor** button.

The Carrier Squelch indicator appears on the display when you monitor a channel using the preprogrammed Monitor button.
  - b. Press and hold the **Volume Set** button to hear the volume set tone.
  - c. Adjust the **Volume Control Knob** if necessary.
  - d. Release the **Volume Set** button.
  - e. Press and hold the **PTT** button to transmit.

The LED lights up solid red.
  - f. Release the **PTT** button to receive (listen).

### 1.6.2

## Monitoring Conventional Mode

### When and where to use:

Your radio may be preprogrammed to receive Private-Line® (PL) calls.

### Procedure:

- 1** Momentarily press the **Monitor** button to listen for activity.

The Carrier Squelch indicator appears on the display.
- 2** Press and hold the **Monitor** button to set continuous monitor operation.

The duration of the button press is programmable.
- 3** Press the **Monitor** button again, or the **PTT** button, to return to the original squelch setting.

If you try to transmit on a receive-only channel, you hear an invalid tone until you release the **PTT** button.

# Advanced Features

This chapter explains the operations of the features available in your radio.

## 2.1

### ViQi

ViQi is a virtual assistant that helps you manage your radio and perform information lookups using voice commands. This feature is purpose-built for public safety and is active when you press the assigned **ViQi** button on the radio, Remote Speaker Microphone (RSM), or compatible mobile microphone.



**NOTICE:** This feature is a selling feature.

To perform queries you are required to login to CommandCentral. See [Logging In to CommandCentral](#).

### ViQi Virtual Partner

ViQi Virtual Partner helps you to look up information such as license plate, driver's license, and Vehicle ID Number (VIN), and she responds with a result to your query.

Table 1: ViQi Virtual Partner Queries

The following table shows the queries supported by the ViQi Virtual Partner feature and their respective commands. Use the following commands followed by the supported query instructions to initiate ViQi Virtual Partner:

- "Look up..."
- "Check..."
- "Run a..."

Query	Examples
License plate	"Run a <i>&lt;State&gt;</i> license plate <i>&lt;Alphanumeric String&gt;</i> " "Check a <i>&lt;State&gt;</i> license plate" "Look up <i>&lt;State&gt;</i> license plate <i>&lt;Alphanumeric String&gt;</i> "
Driver's license	"Run a <i>&lt;State&gt;</i> driver's license <i>&lt;Alphanumeric String&gt;</i> " "Check the state of <i>&lt;State&gt;</i> driver's license <i>&lt;Alphanumeric String&gt;</i> " "Look up <i>&lt;State&gt;</i> driver's license <i>&lt;Alphanumeric String&gt;</i> "
Vehicle Identification Number	"Check Vehicle Identification Number <i>&lt;Alphanumeric String&gt;</i> " "VIN check <i>&lt;Alphanumeric String&gt;</i> " "Run a VIN"  <b>NOTICE:</b> You can use variations such as <i>&lt;Vehicle Identification Number&gt;</i> , <i>&lt;VIN&gt;</i> , and <i>&lt;Vehicle Number&gt;</i> .

### 2.1.1

## Using ViQi Virtual Partner

**Prerequisites:** See [ViQi on page 44](#) for the queries supported by this feature.

**Procedure:**

- 1 Press and hold the assigned **ViQi** button.
- 2 After you hear a tone, clearly speak your request into the microphone.
- 3 Release the assigned programmable button and wait for ViQi to respond.
- 4 Throughout your session, repeat steps [step 1](#) through [step 3](#) when responding to ViQi. Depending on your query, you can also say the following requests:
  - To play the available results, say "Play results".
  - To request for more details, say "More details".
  - To complete the Virtual Partner session, say "Complete".

### 2.2

## Advanced Call Features

This chapter explains the operations of the call features available in your radio.

### 2.2.1

## Selective Call (ASTRO Conventional Only)

This feature allows you to receive a call from a specific individual with privacy.

#### 2.2.1.1

### Receiving a Selective Call

**When and where to use:** When you receive a Selective Call, you hear two alert tones and the LED lights up solid yellow. The backlight of the screen turns green momentarily, the display briefly shows `CALL RCV`, and the speaker unmutes.

**Procedure:**

- 1 Hold the radio vertically 1 to 2 inches (2.5 to 5.0 cm) from your mouth.
- 2 Press and hold the **PTT** button to talk. Release the **PTT** button to listen.

#### 2.2.1.2

### Making a Selective Call

**Prerequisites:** Your radio must be preprogrammed for you to use this feature.

**Procedure:**

- 1 Press the preprogrammed **Quick Access (One-Touch) Selective Call** button to dial the preprogrammed ID.
- 2 Hold the radio vertically 1 to 2 inches (2.5 to 5.0 cm) from your mouth.
- 3 Press and hold the **PTT** button to start the Selective Call.

The display shows the current zone and channel name.

- 4 Release the **PTT** button to listen.

The radio returns to home screen. Repeat [step 1](#) to [step 3](#) to start the Selective Call.

### 2.2.2

## Making a Priority Dispatch Calls

If a talkgroup is congested, the Priority Dispatch feature allows you to call the dispatcher on a different talkgroup. This talkgroup is called the Priority Talkgroup. Each trunking talkgroup can have its own assigned Priority Talkgroup. Priority Dispatch is not available during Emergency operations. Scan feature is suspended when Priority Dispatch is initiated.

**Prerequisites:** Dispatch console that supports this feature must be preprogrammed to use this feature. Check with your dealer or system administrator for more information on dispatch console supporting this feature.

### Procedure:

- 1 Press the preprogrammed **Priority Dispatch** button.

A tone sounds and the radio enters Priority Dispatch mode. The radio exits this mode when the Priority Dispatch Time Out Timer expires.

- 2 Before the Priority Dispatch Time Out Timer expires, press and hold the **PTT** button to transmit.

The display shows the Priority Talkgroup alias.

- 3 Release the **PTT** button to listen.

The radio exits Priority Dispatch mode, returns to its original talkgroup, and displays the home channel alias.

### 2.2.3

## Dynamic Regrouping (Trunking Only)

This feature allows the dispatcher to temporarily reassign selected radios to a particular channel where they can communicate with each other. This feature is typically used during special operations.

When your radio is dynamically regrouped, it receives a dynamic regrouping command and automatically switches to the dynamically regrouped channel. You hear a gurgle tone and the display shows the name of the dynamically regrouped channel.

When the dispatcher cancels dynamic regrouping, the radio automatically returns to the previous zone and channel that you were using.

If you access a zone or channel that has been reserved as a dynamically regrouped mode for other users, you hear an invalid tone.

### 2.2.3.1

## Requesting a Reprogram (Trunking Only)

**When and where to use:** This feature allows you to notify the dispatcher when you want a new dynamic regrouping assignment.

### Procedure:

Press the preprogrammed **Reprogram Request** button to send reprogram request to the dispatcher.

The display shows `RPGM` and `PLS WAIT`.

If you hear five beeps, the dispatcher has acknowledged the reprogram request. The display shows `ACK RCVD` and the radio returns to the **Home** screen.

If the dispatcher does not acknowledge the reprogram request within six seconds, you hear a low-pitched alert tone and the display shows `NO ACK`.

### 2.2.3.2

## Classification of Regrouped Radios

The dispatcher can classify regrouped radios into Select Enabled or Select Disabled categories.

### Select Enabled

Select-enabled radios are free to change to any available channel, including the dynamic-regrouping channel, once you have selected the dynamic-regrouping position.

### Select Disabled

Select-disabled radios cannot change channels while dynamically regrouped. The radio is forced to remain on the dynamic-regrouping channel.

The Scan and Private Call features are unavailable when your radio is Select Disabled.

## 2.3

## Scan Lists

Scan lists are created and assigned to individual channels/groups. Your radio scans for voice activity by cycling through the channel/group sequence specified in the scan list for the current channel/group.

Your radio supports different types of Scan Lists:

- Trunking Priority Monitor Scan List
- Conventional Scan List
- Talkgroup Scan List

Refer to a qualified radio technician for the maximum number of Scan Lists can be preprogrammed in your radio.

### 2.3.1

## Intelligent Priority Scan

Intelligent Priority Scan feature allows you to add or delete conventional channels and trunking talkgroups from multiple system into the priority scan lists.

You can add or delete priority scan list members and assign priorities using the preprogrammed **Scan List Programming** button. Radio displays the priority level of the scanned member.



**NOTICE:** Priority-One channel and Priority-Two channel member may belong to different Talkgroup Scan systems.

When the radio locks onto a channel in the Intelligent Priority Scan list, radio scans for higher priority member within the same Trunking or Conventional system.

### 2.3.2

## Viewing a Scan List

### Procedure:

Turn the **16-Position Select Knob** to view the members on the list.

### 2.3.3

## Viewing and Changing the Priority Status

### Procedure:

Press the **Top Side (Select)** button to change the priority status of the currently displayed channel or the scan list status icon of the currently displayed channel.

The radio shows one of following priority status icons and scenarios:

- A **Scan** icon indicates that the current channel is in the scan list as a non-priority channel. The LED lights up solid green.
- A **Priority-One Channel Scan** icon indicates that the current channel is in the scan list as the Priority-One channel. The LED rapidly blinks green. You hear all traffic on the Priority-One channel, regardless of traffic on non-priority channels.
- A **Priority-Two Channel Scan** icon indicates that the current channel is in the scan list as the Priority-Two channel. The LED blinks green.
- No icon indicates that the current channel is deleted from the scan list.

## 2.4

## Scan

This feature allows you to monitor traffic on different channels by scanning a preprogrammed list of channels.

### 2.4.1

## Turning Scan On or Off

### Procedure:

Press the preprogrammed **Scan** button to toggle **SCAN ON** or **SCAN OFF** to initiate or stop scan.

If the scan is enabled, the display shows **SCAN ON** and the scan status icon.

If the scan is disabled, the display shows **SCAN OFF**.

### 2.4.2

## Making a Dynamic Priority Change (Conventional Scan Only)

### When and where to use:

While the radio is scanning, the dynamic priority change feature allows you to temporarily change any channel in a scan list (except for the Priority-One channel) to the Priority-Two channel.



This change remains in effect until scan is turned off. Scan then reverts to the default setting.

**Procedure:**

- Making a Dynamic Priority Change using the preprogrammed **Dynamic Priority** button:
  - a. When the radio locks onto the channel designated as the new Priority-Two channel, press the preprogrammed **Dynamic Priority** button.

The radio continues scanning the remaining channels in the list.

### 2.4.3

## Deleting a Nuisance Channel

**When and where to use:**

If a channel continually generates unwanted calls or noise (termed “nuisance” channel), you can temporarily remove the unwanted channel from the scan list.

This capability does not apply to priority channels or the designated transmit channel.



**NOTICE:** Deleting a nuisance channel is **only** possible through the preprogrammed **Nuisance Channel Delete** button.

**Procedure:**

When the radio is locked onto the channel to be deleted, press the preprogrammed **Nuisance Delete** button.

The radio continues scanning the remaining channels in the list.

### 2.4.4

## Restoring a Nuisance Channel

**Procedure:**

To restore the deleted nuisance channel, perform one of the following actions:

- Stop and restart a scan.
- Mode change to another channel and back to the original channel.
- Turn off the radio and then turn it on again.

Nuisance mode delete can be disabled by the system administrator.

### 2.5

## Call Alert Paging

This feature allows your radio to work like a pager.

The radio which you missed its call can send a Call Alert page to your radio. The sender can also verify if your radio is active.



**NOTICE:** This feature must be preprogrammed by a qualified radio technician.

### 2.5.1

## Receiving a Call Alert Page

**When and where to use:** When you receive a Call Alert page, you hear four repeating alert tones and the LED blinks green. The call received icons blinks and the display shows PAGE RCV.

**Procedure:**

Press any button to clear the Call Alert page.

### 2.5.2

## Sending a Call Alert Page

**When and where to use:**

Your radio must be preprogrammed for you to use this feature.

**Procedure:**

- Press the preprogrammed **Quick Access (One-Touch) Call Alert Paging** button to send a page to the preprogrammed ID.

If the call alert page is sent successfully, a tone sounds and the display shows the current zone and channel name.

If the call alert page is not acknowledged, a tone sounds and the display shows the current zone and channel name.

## 2.6

## Emergency Operation

The Emergency feature is used to indicate a critical situation. If the **Orange** button is preprogrammed to send an emergency signal, this signal overrides any other communication over the selected channel.

Your radio supports the following Emergency modes:

- Emergency Alarm
- Emergency Call (Trunking Only)
- Emergency Alarm with Emergency Call
- Silent Emergency Alarm

Check with your dealer or system administrator for more information on the programming of this feature.

Only **one** of the Emergency modes can be assigned to the preprogrammed **Emergency** button.

The radio operates in the normal dispatch manner while in Emergency Call, except if enabled, it returns to one of the following:

**Tactical/Non-Revert**

The radio sends an emergency alarm and/or makes an emergency call on the current channel.

**Non-Tactical/Revert for Conventional System**

The radio reverts to the preprogrammed emergency channel to send an alarm and/or make an emergency call.

**Non-Tactical/Revert for Trunking System**

The radio reverts to the preprogrammed emergency talkgroup (trunking system) or channel (conventional system) to send an alarm and/or make an emergency call.

Man Down is an alternate way to activate the Emergency feature on the condition the Emergency must be set up for this feature to operate.

The receiving radio distinguishes the two types of emergency by displaying the following:

- When receiving an Emergency, the radio displays `EA received`.
- When receiving a Man Down alarm, the radio displays `MDown received`.

The receiving radio mutes any incoming voice, then sounds an emergency receiving tone. The radio unmutes the voice after two seconds.

Distinguishing Emergency and Man Down feature is enabled through CPS configuration. Check with your dealer or system administrator for more information.

See [Man Down on page 58](#) for details.

### 2.6.1

## Exiting Emergency

The dispatch console that supports this feature can be programmed to clear the emergency state of the radio. Check with your dealer or system administrator for more information on dispatch console supporting this feature.

#### Procedure:

To exit emergency, press and hold the preprogrammed **Emergency** button for about a second.

### 2.6.2

## Exiting Emergency as Supervisor (Trunking Only)

Radios configured as Supervisor are able to cancel emergency mode of other radios. The dispatch console must be preprogrammed to use this feature. Check with your dealer or system administrator for more information on dispatch console supporting this feature.

#### Procedure:

- 1 Perform one of the following actions.

If...	Then...
<b>If the emergency mode is initiated by other radios,</b>	press and hold the <b>Side Button 1</b> and press the <b>Emergency</b> button.
<b>If the emergency mode is initiated by the Supervisor,</b>	Perform one of the following actions. <ul style="list-style-type: none"> <li>• Press and hold the <b>Emergency</b> button.</li> <li>• Press and hold the <b>Side Button 1</b> and press the <b>Emergency</b> button.</li> <li>• Wait for console to clear emergency.</li> </ul>



**NOTICE:** The following buttons combinations are supported:

- Radio **Side Button 1** and **Top (Orange)** button.
- Radio **Side Button 1** and accessory **Orange** button.
- Accessory **1-Dot Button** and radio **Top (Orange)** button.
- Accessory **1-Dot Button** and accessory **Orange** button.

### 2.6.3

## Sending an Emergency Alarm

**When and where to use:** This feature allows you to send a data transmission, which identifies the radio sending the emergency, to the dispatcher.



**NOTICE:** The default timer of **Emergency** button press to activate Emergency is 50 milliseconds. This timer is programmable from 50–6200 milliseconds by a qualified technician.

### Procedure:

Press the preprogrammed **Emergency** button.

One of the following scenarios occurs:

- The display shows `EMERGENCY` and the current zone or channel. You hear a short medium-pitched tone and the LED blinks red momentarily.
- The radio sounds a short low-pitched tone to indicate that the selected channel does not support emergency and rejects to launch emergency mode.

When you receive the dispatcher's acknowledgment, the display shows `ACK RCVD`. Four tones sound, the alarm ends, and the radio exits the Emergency Alarm mode.

If no acknowledgment is received, the display shows `NO ACK`. The alarm ends and the radio exits the Emergency Alarm mode.

### 2.6.4

## Sending an Emergency Call (Trunking Only)

**When and where to use:** This feature gives your radio priority access to a talkgroup.

### Procedure:

- 1 Press the preprogrammed **Emergency** button.

One of the following scenarios occurs:

- The display shows `EMERGENCY` and the current zone or channel. You hear a short medium-pitched tone and the LED blinks red momentarily.
- You hear the radio sounds a short low-pitched tone to indicate the selected channel does not support emergency and rejects to launch emergency mode.

- 2 Hold the radio vertically 1 to 2 inches (2.5 to 5.0 cm) from your mouth.

- 3 Press and hold the **PTT** button. Speak clearly into the microphone.

- 4 Release the **PTT** button to end the transmission and wait for a response from the dispatcher.

- 5 To exit Emergency Call, press and hold the preprogrammed **Emergency** button for about a second.

### 2.6.5

## Sending An Emergency Call With Hot Mic (Trunking Only)

This feature allows you to send an Emergency Call with hot mic to a group of radios.

### When and where to use:

Your radio must be programmed for this type of operation.

Your radio microphone is automatically activated, allowing you to communicate with the group of radios without pressing the **PTT** button. This activated microphone state is also known as hot mic. The hot mic applies to the first voice transmission from your radio during the Emergency call. For subsequent transmissions in the same Emergency call, you must press the **PTT** button.

Follow the procedure to send Emergency Call with hot mic on your radio.

**Procedure:**

- 1 Press the preprogrammed **Emergency** button.

One of the following scenarios occurs:

- The display shows `EMERGENCY` and the current zone or channel. A tone sounds and the LED blinks red momentarily.
- A tone sounds to indicate the selected channel does not support emergency and rejects to launch emergency mode.

- 2 Hold the radio vertically 1 to 2 inches (2.5 to 5.0 cm) from your mouth.
- 3 The microphone remains active for the hot mic time specified in the radio's codeplug programming.
- 4 To exit Emergency Call, press and hold the preprogrammed **Emergency** button.

### 2.6.6

## Sending an Emergency Alarm with Emergency Call

**When and where to use:**

This feature gives your radio priority access on a channel for conventional system, and to a talkgroup for trunking system.

**Procedure:**

- 1 Press the preprogrammed **Emergency** button.

If successful, the display shows `EMERGENCY` on the current zone and channel. You hear a short, medium-pitched tone and the LED blinks red momentarily.

The radio exits Emergency Alarm and enters the Emergency Call state when one of the following scenarios occur:

- You receive the dispatcher acknowledgment. The display shows `ACK RCVD`.
- You receive no acknowledgment. The display shows `NO ACK`.
- You press the **PTT** button while in the Emergency Alarm mode.

If unsuccessful, you hear the radio sounds a short low-pitched tone to indicate the selected channel does not support emergency and rejects to launch emergency mode.

- 2 Hold the radio vertically 1 to 2 inches (2.5 to 5.0 cm) from your mouth.
- 3 Press and hold the **PTT** button. Speak clearly into the microphone.
- 4 Release the **PTT** button to end the transmission and wait for a response from the dispatcher.
- 5 To exit Emergency Call, press and hold the preprogrammed **Emergency** button for about a second.

Turning off the radio also cancels the emergency state.

### 2.6.7

## Sending An Emergency Alarm and Call with Hot Mic

This feature allows you to send an Emergency Alarm and Call with hot mic to a group of radios.

**When and where to use:** Your radio must be programmed for this type of operation. Follow the procedure to send Emergency Alarms and Call with hot mic on your radio.

#### Procedure:

- 1 Press the preprogrammed **Emergency** button.

If successful, the display shows `EMERGENCY` on the current zone and channel. A tone sounds and the LED blinks red momentarily.

The radio exits Emergency Alarm and enters the Emergency Call state when one of the following scenarios occur:

- You receive the dispatcher acknowledgment. The display shows `ACK RCVD`.
- You receive no acknowledgment. The display shows `NO ACK`.

If unsuccessful, a tone sounds to indicate the selected channel does not support emergency and rejects to launch emergency mode.

- 2 Hold the radio vertically 1 to 2 inches (2.5 to 5.0 cm) from your mouth.
- 3 The microphone remains active for the hot mic time specified in your radio's codeplug programming.
- 4 To exit Emergency Call, press and hold the preprogrammed **Emergency** button.  
Turning off the radio also cancels the emergency state.

### 2.6.8

## Sending a Silent Emergency Alarm

**When and where to use:** This feature allows you to send an Emergency Alarm to the system without triggering any audio or visual indicators.

#### Procedure:

- 1 Press the preprogrammed **Emergency** button.

The display shows no changes, the LED does not light up, and you hear no tones. The silent emergency state continues until you perform the next step.

- 2 Perform one of the following actions.
  - Press and hold the preprogrammed **Emergency** button for about a second to exit the Silent Emergency Alarm mode.
  - Press and release the **PTT** button to exit the Silent Emergency Alarm mode and enter regular dispatch or Emergency Call mode.

## 2.6.9

## Special Considerations for Emergencies

The following scenarios apply during Emergency mode:

Table 2: Emergency Operations Scenarios

If...	Then...
If you press the <b>Emergency</b> button while in a channel that has no Emergency capability,	a low-pitched tone sounds.
If you change to a channel/mode with Emergency capability while in Emergency operation,	the Emergency Alarm and/or Emergency Call continues on the new channel/mode.
If you change to a channel/mode with no Emergency capability while in Emergency operation,	the following occurs: <ul style="list-style-type: none"> <li>• The display shows NO EMERG.</li> <li>• A continuous low-pitched tone sounds until you select a valid Emergency channel/mode or until you disable the Emergency operation.</li> </ul>
If the radio is out-of-range of the system or the emergency alarm is not acknowledged,	a tone sounds and the display shows No ac-knowledge.

## 2.6.10

## Emergency Keep-Alive

This feature prevents the radio from being turned off when it is in Emergency mode. If this feature is enabled and you want to turn off your radio, exit Emergency mode before turning it off.

## 2.7

## Fireground

The portable Fireground Communications System is designed for deployment at an incident scene. It consists of central components that provide on-scene and inbuilding radio coverage, and enhanced personnel accountability and monitoring:

- Your APX portable radios
- Incident Management Software
- Command Terminal
- Radio Frequency (RF) Modem (Conventional Only)
- Control Channel Radio (Trunking)
- Optional Data Radio (Trunking)
- Accountability Server (Trunking)
- DVRS (Optional)

If you have a critical situation, you can press the Emergency button which activates an alarm on the Incident Management Software at the command terminal.

The command terminal receives the following status updates from your radio:

- Turning the radio on and off
- Automatic response to Polling

- Response to Evacuation commands
- Pressing the **PTT** button to make voice transmission
- Sending an Emergency Alarm and Call
- Entering or Exiting a Trunking Talkgroup

### 2.7.1

## Entering Fireground Zone Channel (Conventional)

### Procedure:

- 1 Upon powering up, one of the following scenarios occurs:
  - If the Fireground Zone Channel is set as default, you hear the gurgle tone and the radio displays the home screen. You are in Fireground zone channel.
  - If the Fireground Zone Channel is set as default, but you hear a short, low-pitched tone, the display shows `REG FAIL` to indicate that the command terminal does not respond to Fireground Zone Channel. Get a qualified technician for assistance.
  - If your home channel is not Fireground Zone Channel, toggle or change the radio zone channel to Fireground Zone Channel.

If you are entering Fireground Trunking Talkgroup, upon powering up, ensure that the Fireground Trunking Talkgroup is selected. The subscriber unit automatically appears on the Incident Commander's terminal.

- 2 Listen for a transmission. Adjust the **Volume Control Knob** if necessary.
- 3 Perform one of the following actions.
  - Press and hold the preprogrammed **Volume Set** button to hear the volume set tone. Adjust the **Volume Control Knob** if necessary. Release the **Volume Set** button.
  - At the desired Fireground zone and channel, press the preprogrammed **Monitor** button and listen for activity. Adjust the **Volume Control Knob** if necessary.
  - If your radio is working in Fireground Zone Channel, proceed to next step.
- 4 Press and hold the **PTT** button to transmit. The LED lights up solid red while transmitting. Talk into the microphone clearly if needed.
- 5 Release the **PTT** button to receive.  
You hear a Transmit End Tone.

### 2.7.2

## Sending Evacuation Tone

This feature enables the evacuation tone to be heard on the transmitting radio and on any radio that is able to receive the tone instruction.

### Procedure:

Press and hold the **PTT** button and then short press the **Top (Orange)** button.

Once the tone begins to sound, if the orange button is released the tone continues to alarm on all radios within the talkgroup, until the **PTT** button is released.



**NOTICE:** Radio does not transmit evacuation tone if the radio is in secure mode.



### 2.7.3

## Responding to Evacuation Indicator

**When and where to use:** The Incident Commander can trigger one of sixteen Tactical Alerts from the Command Terminal. These alerts can target individuals or groups of users within the Fireground Communication System. The ergonomic (visual and audible) response for the Tactical Alerts can be customized.

Your radio sounds the audible response at the profile maximum alert tone volume level. The display shows the configurable programmed alert text and intelligent lighting.

### Procedure:

- 1 Perform one of the following actions:
  - Press the radio **Top Side** button.
  - Press the RSM **Side Button 1** if the radio is connected to RSM.
  - Press the **PTT** button. **PTT** button must be configured in CPS to enable this function.

The radio cancels the indications, a tone sounds and the radio sends an acknowledgment to the command terminal.



**NOTICE:** Move the **Volume Control Knob** to adjust the volume of the audible alert from full volume.

### 2.8

## Tactical Public Safety (TPS) (Conventional Only)

TPS enables the user of a group to identify the start and the end of a transmission by displaying the caller name or ID on the radio display.

### 2.8.1

## Using TPS Normal Transmission

### Procedure:

At TPS Zone Channel, perform one of the following actions:

- Press **PTT** button to transmit. Talk clearly into the microphone. Release **PTT** button to listen.
- Receive and listen to call, the radio displays the caller's name or ID.

### 2.8.2

## Using TPS Emergency Transmission

### When and where to use:

The following are two important alert tones designed for this feature.

### Emergency Beacon

During Emergency if the TPS radio user pushes the **Emergency** button, the radio sounds a Beacon at the maximum volume of the radio at radio's internal speaker and it is not adjustable. This beacon goes to silent when user presses the **PTT** button for voice transmission.

### Emergency Call De-Key Sidetone

The radio sounds an alert tone to remind radio user that the Emergency Mode is still active after user releases the **PTT** button for an Emergency call transmission. The volume of loudness depends on the maximum tone at your radio profile.

#### Procedure:

- 1 Press the **Emergency** button to enter Emergency Mode.  
You hear the Emergency Beacon.
- 2 Press **PTT** button to make an Emergency Call.
- 3 Release to listen.  
You hear Emergency Call De-Key Sidetone. After a short pause, you hear Emergency Beacon.
- 4 Long press **Emergency** button to exit Emergency mode and cancel Emergency Beacon.

## 2.9

### Man Down

Man Down condition is determined based upon the radio tilt angle or a combination of radio tilt angle and the lack of radio motion.

Man Down feature is an alternate way to activate the Emergency feature if Emergency has been programmed in your radio.



**NOTICE:** This feature could be preprogrammed for all channels that support Emergency feature or could be preprogrammed specifically to a zone and channel which has Emergency feature. Consult your agent or qualified technician for more details.

Your radio automatically activates Emergency Alarm or Call when the radio achieves or passes a tilt angle threshold or a combination of the angle threshold and radio motion below the motion sensitivity level, depending upon how the radio is programmed. The radio must stay in this condition for a preprogrammed amount of time before the Emergency Alarm or Call is activated.



**NOTICE:** It is recommended that an Emergency button is preprogrammed in order to allow the user to exit the emergency condition.

The Man Down feature provides a **Clear** function to the user. After a Man Down condition has been detected, the user can press a preprogrammed **Clear** button to cancel the Man Down condition. The radio remains in the Man Down state without triggering an emergency condition until the radio is moved out of the Man Down state, at which point Man Down functionality resumes.

The Man Down feature has three phases:

- 1 The radio senses the Man Down condition and Pre-Alert Timer is initiated.
- 2 Man Down condition continues for the time duration defined in the Pre-Alert Timer field. At the end of this time, the radio alerts the user on the Man Down status with an audible alert tone and **MAN-DOWN** text on the screen. The Post-Alert Timer also initiates at this point.
- 3 Man Down condition continues for the time duration defined in the Post-Alert Timer field. Once the timer expires, the Emergency alarm is transmitted. The Man Down Clear function is used in this phase to cancel the Man Down condition.

The following scenarios affect the timers:

- Pressing the **PTT** button suspends the Man Down timers; releasing the **PTT** button re-initiates the Pre-Alert Timer.
- Pressing other buttons on the radio does not impact these timers.
- Repositioning the radio exits the Man Down feature, which stops and resets the timers.

- Pressing a preprogrammed **Clear** button or pressing a **Menu Select** button preprogrammed for **Clear** stops and resets the timers. The timers do not restart until the radio is repositioned.



**NOTICE:** Emergency must be set up for this feature to operate. For details on operating the Emergency alerts, please see [Emergency Operation on page 50](#).

If the radio is preprogrammed to horizontal only, it must be worn in a vertical position otherwise the Man Down alert may be inadvertently triggered.

When the radio is programmed with Man Down feature, special care is required when charging the radio with a wall mounted charger. See [Radio Care on page 16](#) for details.

### 2.9.1

## Pre-Alert Timer

This timer sets the amount of time that a Man Down condition must be present before the radio-user is warned of the Man Down condition.

When the radio detects that it has returned to the vertical position or when the radio detects motion, the Pre-Alert timer stops and is reset.

The Pre-Alert timer reinitiates when the radio detects it is in the horizontal position or motionless again.

### 2.9.2

## Post-Alert Timer

This timer sets the amount of time the radio needs to remain in the Man Down condition before the Emergency alarm is transmitted. When the Post-Alert Timer is initiated, the radio alerts the user with an audible tone and displays the “MAN-DOWN” text.

See [Exiting Man Down Feature on page 60](#) to exit Man Down feature.

### 2.9.3

## Radio Alerts When Man Down Feature is Triggered

The Man Down alert tone volume is directly related to the radio speaker volume. Ensure that the radio speaker volume is loud enough so that the user does not miss the Post-Alert tone.



**NOTICE:** If the radio is programmed with Silent Emergency, the radio inhibits the alert tone and visual alert associated with the emergency feature.

If the radio is programmed in Surveillance Mode, the radio inhibits all tones and lights on the radio including the Man Down tones.

### 2.9.4

## Triggering Emergency

When the user does not clear the Man Down condition and the Post-Alert Timer comes to an end, Emergency Alarm or call is triggered. The radio sends emergency message to units within the same Talkgroup. The radio also sends ID number and GPS coordinates to dispatcher if these features are enabled. User can exit Emergency following the Emergency procedure. See [Emergency Operation on page 50](#) for details.



**NOTICE:** At this point the Man Down features is complete. Use normal Emergency procedures to cancel Emergency transmissions.

### 2.9.5

## Radio Alerts When Man Down Enhanced is Triggered



**NOTICE:** This feature is to be preprogrammed specifically to a zone and channel which supports Emergency feature.

The volume and repetition duration of Man Down Enhanced alert tone could be customized and preprogrammed to suite the required situation.

Consult your agent or qualified technician for more details.

When the radio initiates Man Down Enhanced, you hear the Critical Man Down Continuous alert tone from the radio speaker. The volume of this tone is set to the louder of the preprogrammed minimum level or the current radio speaker level. This acts as a beacon to find the radio.



**NOTICE:** If the radio is programmed with Silent Emergency, the radio inhibits the alert tone and visual alert associated with the emergency feature.

If the radio is programmed in Surveillance Mode, the alert tone can be heard from the radio speaker.

Once the alert tone is active, changing to another channel with different setup triggers a different response from the radio as described next.

- The alert tone is inhibited when you change to a channel without Emergency feature.
- The alert tone is inhibited when you change to a channel with Emergency but no Man Down feature.
- The current alert tone is inhibited and is replaced with a different alert tone when you change to a channel with Emergency and different Man Down configuration.
- The alert tone continues when you change to a channel with Emergency and similar Man Down configuration.

### 2.9.6

## Exiting Man Down Feature

**When and where to use:** If you are not in a real Man Down situation, you should exit the Man Down feature and prevent emergency from going off with the following operation.

### Procedure:

Perform one of the following actions:

- Repositioning the radio or shaking the radio (when motion sensitivity is enabled).
- Press the preprogrammed **Man Down Clear** button to exit.

### 2.9.7

## Re-Initiating Man Down

**Prerequisites:** After exiting the Emergency Operation when the radio is still in Man Down condition (tilted achieving threshold angle or motionless), user must first exit Man Down condition to then reinitiate the Man Down feature.

### Procedure:

Return the radio to the vertical position or shake the radio (when motion sensitivity is enabled).

### 2.9.8

## Testing the Man Down Feature

**Prerequisites:** Enable the Emergency feature with Silent Alarm disabled, but not in Surveillance Mode before running this test on the radio.

**Procedure:**

- 1 Turn the radio on and place in the vertical position, for at least 5 seconds.
- 2 Lay the radio down in the horizontal position.
- 3 Wait for alert tone.

One of the following scenarios occurs:

- The radio alerts with audible tone and displays `MAN-DOWN`.
- If no tone is heard, make sure that the Man Down feature is enabled on your radio. If Man Down feature was not enabled, please enable it and repeat [step 1](#) to [step 3](#).
- If the Man Down feature is enabled and no tone is heard, send the radio to a qualified technician.

### 2.10

## Secure Operations

Secure radio operation provides the highest commercially available level of voice security on both trunked and conventional channels.

By default, the radio automatically enters the encrypted environment without having to manually select or clear the secure transmission.

### 2.10.1

## Selecting Secure Transmissions

**Procedure:**

Turn the preprogrammed **Secure/Clear** switch to the secure position.

- If the selected channel is preprogrammed for clear-only operation, when you press the **PTT** button, you hear an invalid mode tone and the display shows `CLR TX`.
- The radio does not transmit until you set the **Secure/Clear** switch to the clear position.
- If the “Ignore **Secure/Clear** Switch when Strapped” programming option is enabled, the radio transmits without displaying any messages in the strapped mode of operation, regardless of the **Secure/Clear** switch setting. This option must be preprogrammed by a qualified radio technician.
- The **Secure/Clear** switch only applies when the radio is transmitting.

### 2.10.2

## Selecting Clear Transmissions

**Procedure:**

Turn the preprogrammed **Secure/Clear** switch to the clear position.

- If the selected channel is preprogrammed for secure-only operation, when you press the **PTT** button, you hear an invalid mode tone and the display shows `SEC TX`.
- The radio does not transmit until you set the **Secure/ Clear** switch to the secure position.

- You can request to configure the radio to ignore the clear voice or insecure transmission when the radio is in secured transmission. Check with your agent for details.
- If the “Ignore **Secure/Clear** Switch when Strapped” programming option is enabled, the radio transmits without displaying any messages in the strapped mode of operation, regardless of the **Secure/Clear** switch setting. This option must be preprogrammed by a qualified radio technician.
- The **Secure/Clear** switch only applies when the radio is transmitting.

### 2.10.3

## Managing Encryption

This chapter explains the encryption feature on your radio.

### 2.10.3.1

## Loading Encryption Keys

### Prerequisites:

- Refer to the *Key Variable Loader (KVL) manual* for equipment connections and setup.

### Procedure:

- 1 Attach the KVL to your radio.

The display shows `KEYLOAD` and all other radio functions, except for power down, backlight, and volume, are locked out.



### NOTICE:

If the Multi-system Over-the-Air Rekeying feature is in use, the ASTRO profile name is displayed below `KEYLOAD`.

- 2 Select the required keys and press **Load** on the KVL.

The KVL indicates that keyload is successful.

### 2.10.3.2

## Multikey Feature

This feature allows the radio to be equipped with different encryption keys and supports the DES-OFB algorithm.

There are two types of encryption keys:

### Conventional Multikey

The encryption keys are strapped on a one-per-channel basis, through CPS. In addition, you can have operator-selectable keys, operator-selectable keysets, and operator-selectable key erasure. If talkgroups are enabled in conventional, then the encryption keys are strapped to the talkgroups.

### Trunked Multikey

If the radio is used for both conventional and trunked applications, strap the encryption keys for trunking on a per-talkgroup or announcement-group basis. In addition, a different key can be strapped to other features, such as dynamic regrouping, failsoft, or emergency talkgroup. You can have operator-selectable key erasure.

### 2.10.3.3

## Erasing Encryption Keys

If the Multi-system Over-the-Air Rekeying feature is in use, the keys erased are only for the current secure profile of the selected channel. The erase all menu operates as configured by the dealer or system administrator. Erasing all keys using the Top (Orange) button and the Top Side (Select) button erases all keys in all keylists in the radio.

### Procedure:

- Erasing the single key in radios with the single-key option and erasing all keys in radios with the multikey option by using the preprogrammed **Top Side (Select)** button and **Top (Orange)** button:
  - a. Press and hold the **Top Side (Select)** button.
  - b. While holding **Top Side (Select)** button down, press the **Top (Orange)** button.

The display shows `PLS WAIT`. When all the encryption keys have been erased, the display shows `ALL ERASED`.



**NOTICE:** Do **not** press the **Top (Orange)** button before pressing the **Top Side (Select)** button, unless you are in an emergency situation as this sends an emergency alarm.

### 2.10.3.4

## Requesting an Over-the-Air Rekey

If the Multi-system Over-the-Air Rekeying feature is in use, the rekey request is only for the current selected secure profile.

**Prerequisites:** Ensure that the Unique Key Encryption Key (UKEK) or Unique Shadow Key (USK) is loaded into the radio with the Key Variable Loader (KVL) before the rekey request can be sent. Refer to your local key management supervisor for more information.

### Procedure:

- 1 Press and hold the preprogrammed **Rekey Request** button to send the rekey request.  
If the rekey operation fails, a bad-key tone sounds and the display shows `RKY FAIL`.



**NOTICE:** The rekey operation failure indicates that your radio does not contain the UKEK or USK.

### 2.10.3.5

## MDC Over-the-Air Rekeying Page (Conventional Only)

This feature allows you to view or define MDC Over-the-Air Rekeying (OTAR) features. It is applied only when operating in secure encrypted mode. In addition to Rekey Requests, OTAR transmissions include Delayed Acknowledgments, and Power-up Acknowledgments.

Some of the selected options require configuration at the Key Management Controller (KMC) site to work properly.



**NOTICE:** This feature must be preprogrammed by a qualified radio technician. Check with your dealer or system administrator for more information.

### 2.10.3.6

## Infinite UKEK Retention

This feature enables Unique Key Encryption Key (UKEK) to be permanently stored in the radio even when all the encryption keys are erased. Without this UKEK key, the radio cannot be rekeyed over the air. The Infinite UKEK Retention settings can be different for each secure profile.



**NOTICE:** This feature must be preprogrammed by a qualified radio technician. Check with your dealer or system administrator for more information.

### 2.10.3.7

## Hear Clear



**NOTICE:** This feature must be preprogrammed by a qualified radio technician. Check with your dealer or system administrator for more information.

There are two components of Hear Clear.

### Companing

Reduces the channel noise, such as OTA transmission that is predominantly present in UHF2 and 900 MHz channel with the following features.

#### Compressor

Reduces the background noise flow and the speech signal at transmitting radio.

#### Expander

Expands the speech while the noise flow remains the same at receiving radio.

### Random FM Noise Canceller (Flutter Fighter)

Reduces the unwanted effects of random FM noise pulses caused by channel fading under high Signal-to-Noise (S/N) conditions such as in a moving transportation. The fading effects, heard as audio pops and clicks, are canceled without affecting the desired audio signal.

The Random FM Noise Canceller operates only in receive mode.

## 2.11

## Radio Inhibit

This feature allows the system administrator to put a radio into a non-functional state when the radio is missing or in an unknown hand. The radio stays in this state regardless of its power changes.



### NOTICE:

If the radio has Inter-system roaming capability, the system administrator is able to put the radio into a non-functional state when missing radio roamed to another system.

The radio can only be uninhibited by receiving an uninhibited command from the system administrator.

## 2.12

## Global Positioning System/Global Navigation Satellite System

The Global Navigation Satellite System (GNSS) in the radio uses information from the Global Positioning System (GPS) to determine the approximate geographical location of your radio.



**NOTICE:** This feature is addressed as GPS across the manual as the naming convention of the buttons and strings remain the same as the legacy feature of GPS.

The availability and accuracy of this location information (and the amount of time that it takes to calculate it) varies depending on the environment in which you are using the GPS feature.

For example, GPS location fixes are difficult to obtain indoors, in covered locations, between high buildings, or in situations where you have not established a clear broad view of the sky.



Once GPS is enabled, the radio displays the GPS icon on the screen. The dispatcher can always request the system to determine the real-time location coordinates of the radio.

### 2.12.1

## GPS Operation

The GPS technology uses radio signals from earth orbiting satellites to establish location coordinates. Therefore, maximizing your view of unobstructed sky is essential for optimum performance.

Where adequate signals from multiple satellites are not available (usually because you cannot establish a view of a wide area of the sky), the GPS feature of your radio will not work. Such situations include but are not limited to:

- Underground locations
- Inside buildings, trains, or covered vehicles
- Under any metal, or concrete roof, or structure
- Between tall buildings or under dense tree-cover
- In temperature extremes outside the operating limits of your radio

Even where location information can be calculated in such situations, it may take longer to do so, and your location estimate may not be as accurate. Therefore, in any emergency situation, always report your location to your dispatcher.

Keep in mind that the accuracy of the location information and the time it takes to obtain it varies depending upon circumstances, particularly the ability to receive signals from an adequate number of satellites.



**NOTICE:** Even where adequate signals from multiple satellites are available, your GPS feature only provides an approximate location, usually within 10 meters from your actual location, but sometimes farther away.

The satellites used by the GPS feature are controlled by the U.S. government and are subject to changes implemented in accordance with the Department of Defense GPS user policy and the Federal Radio Navigation Plan. These changes may affect the performance of the GPS feature on your radio.

### 2.12.2

## GPS Performance Enhancement

Sometimes, the GPS feature may be unable to complete a location calculation successfully. You then see a message indicating that your radio cannot connect to enough visible satellites.

To maximize the ability of your radio to determine a fix, take note of the following guidelines:

- For your initial fix, hold the radio in the face position.
- Stay in the open. The GPS feature works best where there is nothing between your radio and the open sky.

### 2.12.3

## Location Format

This feature allows you to select different display formats of GPS location.

The following GPS location formats are available:

- Lat/Long(DD)
- Lat/Long(DDM)
- Lat/Long(DMS)
- UTM/UCS

- SLD99
- MGRS



**NOTICE:** When you send your location to another radio, the receiving radio displays the location in its selected format.

#### 2.12.4

### Peer-Location on the Display (ASTRO Conventional only)

This feature is only available for radio-to-radio voice transmissions, dispatch call and selective call in conventional ASTRO system. For radio-to-radio transmission, in order to allow the radio to show peer-location, the voice should be directly sent from one radio to another radio without passing through any infrastructure facility such as repeaters, phone, or DVRS system. Both the transmitting radio and receiving radio must be configured to enable them to send and/or receive the GPS coordinates. You can check with your nearest qualified technician for more details.



**NOTICE:** If the receiving radio is operating in a Mixed Mode channel, and the voice transmission is through the conventional ASTRO system then the radio can receive the location coordinates of its peers.

This feature is also operable in a Scan Active channel or Scan Talkback channel.

Upon receiving a voice transmission with GPS coordinates enabled on the receiving radio, the display shows the coordinates available in full or in short coordinates. There are two different formats available. Refer to the following list for the details shown in the Peer-Location quick text. Consult your agent to pick the best format to configure to your radio.

#### Full location coordinates

- PTT ID (This is optional.)
- Longitude and latitude
- Relative distance or direction

#### Short location coordinates

- PTT ID (This is optional.)
- Longitude and latitude



**NOTICE:** If the transmitting radio is stale at its location after a period of time, the receiving radio display shows `ID:<PTT ID> LKL: <Coordinates> <distance>`. If the radio is not configured to show PTT ID, you see `LAST KNWN LOC: <Coordinates> <distance>`.

If the transmitting radio does not have GPS or the receiving radio could not decode the GPS signal of the received signal, the receiving radio display shows `ID:<PTT ID> UNK LOC`. The PTT ID seen here is optional to be shown on the display per requirement of usage.

#### 2.13

### Trunking System Controls

This chapters explains the trunking system control features in your radio.

#### 2.13.1

### Operating in Failsoft System

#### When and where to use:

The failsoft system ensures continuous radio communication during a trunked system failure. If a trunking system fails completely, the radio goes into failsoft operation and automatically switches to its failsoft channel.

During failsoft operation, your radio transmits and receives in conventional operation on a predetermined frequency. You hear a medium-pitched tone and the display shows `FAILSOFT`.

When the trunking system returns to normal operation, your radio automatically leaves failsoft operation and returns to trunked operation.

To continue in Failsoft and to communicate with other talkgroups, refer to the following procedure.

**Procedure:**

- 1 Rotate the **16-Position Select Knob** to change to a different repeater frequency.
- 2 Press the **PTT** button to talk, and release the button to listen.

### 2.13.2

## Out-of-Range Radio

When your radio goes out of the range of the system, it can no longer lock onto a control channel.

You hear a low-pitched tone and/or the display shows the currently selected zone/channel combination and `OUT RNG`. Your radio remains in this out-of-range condition until it locks onto a control channel or failsoft channel, or if it is turned off.

### 2.13.3

## Site Trunking Feature

If the zone controller loses communication with any site, that site reverts to site trunking. When this occurs, you can communicate only with the radios within your trunking site.

The display shows the currently selected zone/channel combination and `STE TRNK`.

### 2.13.4

## Locking and Unlocking a Site

**When and where to use:** This feature allows your radio to lock onto a specific site and not roam among wide-area talkgroup sites. This feature should be used with caution, since it inhibits roaming to another site in a wide-area system.

**Procedure:**

Use the preprogrammed **Site Lock/Unlock** button to toggle the lock state between locked and unlocked.

The radio saves the new site lock state and returns to the Home screen.

### 2.13.5

## Site Display and Search Button

The **Site Display** and **Site Search** button allows you to view the name of the current site or force your radio to change to a new one.

#### 2.13.5.1

### Viewing the Current Site

**Procedure:**

Press the preprogrammed **Site Displ/Srch** button.

The display shows momentarily the name of the current site and its corresponding received RSSI.

### 2.13.5.2

## Changing the Current Site

### Procedure:

Press and hold down the preprogrammed **Site Displ/Srch** button.

You hear a tone and the display shows momentary `SCANNING`.

When the radio finds a new site, it returns to the Home screen.

### 2.14

## Mission Critical Wireless - Bluetooth®

This feature allows your radio to extend its functionality by connecting to external proprietary Motorola Solutions accessories.

It is recommended to use Motorola Solutions proprietary Mission Critical Wireless (MCW) devices with APX radios during Mission Critical operations as other Bluetooth devices may or may not meet the mission critical standard.

By default, Bluetooth is activated on your radio. Your radio supports the following Bluetooth devices or profiles:

- Headset (HSP)
- Dial Up Networking (DUN)
- Personal Area Networking (PAN)
- Serial Port (SPP)
- General Attribute Profile (GATT)

### 2.14.1

## Turning On Bluetooth

### When and where to use:

### Procedure:

- Turning on the Bluetooth using the preprogrammed button:
  - a. Press the preprogrammed button to turn on the Bluetooth.

You hear a short, medium-pitched tone. The display shows momentarily `BT ON`, and  appears.

If Bluetooth fails to launch, the display shows `BT ON FL`.

### 2.14.2

## Turning Off the Bluetooth

### Procedure:

- Turning off the Bluetooth using the preprogrammed button:
  - a. Press the preprogrammed button to turn off the Bluetooth.

You hear a short, medium-pitched tone. The display shows momentary `BT OFF` and  disappears.

### 2.14.3

## Re-Pair Timer

There are two options for configuring the Bluetooth pairing type of the radio. The type defines the duration the radio and the accessory retain the pairing information.

### Immediate

For MCW accessories only: When the radio and/or device is turned off after pairing, the keys are lost. Due to this, when your radio and your device are turned on again, they are unable to re-connect. The user must re-pair the devices to re-establish a new set of pairing keys. See [Pairing with Low Frequency-Motorola Proximity Pairing \(LF-MPP\) Feature on page 70](#) and [Standard Pairing Feature on page 71](#).

### Infinite

For all Bluetooth devices: When the radio and/or device are turned off after pairing, keys are **not** lost. When the radio and the device are turned on again, they can resume the Bluetooth connection without user intervention.

Re-Pair Timer Options	Re-Pair Timer Scenarios
Immediate (For MCW Accessories only)	<ul style="list-style-type: none"> <li>When the radio is powered off, pairing key is lost immediately, and accessory attempts to pair again. If pairing is unsuccessful within the Drop Timer value, the accessory automatically powers off.</li> <li>When the accessory is powered off, all keys are lost immediately, and the user must re-pair the devices.</li> <li>When the device loses Bluetooth connection, the device will attempt to re-establish Bluetooth Connection within the Drop Timer value.</li> </ul>
Infinite (For all Bluetooth devices)	<ul style="list-style-type: none"> <li>When the radio is powered off, the accessory attempts to re-establish the Bluetooth Connection for a period of time depending upon the Drop Timer value. If the device fails to reconnect within the period, the accessory then powers off.</li> </ul>

### 2.14.4

## Bluetooth Drop Timer

The Bluetooth Drop Timer has two different settings and functions, depending upon the selection of the Re-Pair Timer.

Re-Pair Timer Options	Description
Immediate (For MCW Accessories only)	0–15 minutes programmable buffer time to re-establish the Bluetooth Connection when the Bluetooth signal is out of range. If either device powers <b>off</b> , the pairing keys are immediately cleared from both devices and the devices must re-pair.
Infinite (For all Bluetooth devices)	<p>This Timer only applies to the accessory. The programmable timer choices are: 0–15 minutes, 2 hours, 4 hours, or 8 hours. Do note there are exceptions for Operation Critical Wireless (OCW) headset and <b>PTT</b> which are preprogrammed to 8 hours.</p> <p>This timer is a "stay alive" timer where the accessory remains <b>on</b> without the device reconnecting before powering off. The radio remains <b>on</b> until the user powers <b>off</b> the radio. The radio and acces-</p>

Re-Pair Timer Options	Description
	sory remains paired indefinitely. Once the device re-connect, the timer is reset.

The radio could not control the Drop Timer of Personal Area Networking (PAN), Dial-Up Networking (DUN), Commercial Off- The-Shelf (COTS), and data services. It depends on the specifications of these external devices.

Check with your dealer or system administrator for more information about these timers.

To establish the Bluetooth Connection, see [Pairing with Low Frequency-Motorola Proximity Pairing \(LF-MPP\) Feature on page 70](#) or [Standard Pairing Feature on page 71](#).

#### 2.14.5

### Pairing with Low Frequency-Motorola Proximity Pairing (LF-MPP) Feature

#### Prerequisites:

Ensure that Bluetooth feature of your radio is on and the Bluetooth tones are enabled.

Bluetooth tones, Bluetooth menu and preprogrammed buttons must be preprogrammed by a qualified radio technician. Check with your dealer or system administrator for more information.

**When and where to use:** The range of Bluetooth operation when using a MCW accessory is 10 meters line-of-sight communication. This is an unobstructed path between the location of the signal transmitter (your radio) and the location of the receiver (your device or accessory).

Obstacles that can cause an obstruction in the line-of-sight include trees, buildings, mountains, cars, and others.

For high degree of reliability, Motorola Solutions recommends to **NOT** separate the radio and the accessory.

At the fringe areas of reception, both voice and tone quality will start to sound "garbled" or "broken". To correct this problem, simply position the accessory and radio closer to each other (within the 10 meter defined range) to re-establish clear audio reception.



**NOTICE:** Once a COTS headset is paired to your radio, it is always connected. Therefore the battery life of the accessory is aligned with the Talk Time power consumption, not the Standby Time consumption.

#### Procedure:

Turn on the accessory. Then, place it close to the radio aligning the Bluetooth Pairing Location (a blue dot) on the radio to the Bluetooth Pairing Location (a blue dot) on the accessory.



If the pairing process is successful, you hear an incremental-pitched tone. The radio begins to connect to the device.

If the pairing process fails, you hear a short, low-pitched tone. The display shows `PAIRFAIL`. Repeat this step.

The radio tries to establish connection with the device once paired.



**NOTICE:** If the connection fails within 6 seconds, you hear a decremental-pitched tone to indicate that the device is unpaired. The display shows `<Device Type> UNPAIRED`. Repeat this step to re-initiate the pairing process.

If the connection is successful, you hear an incremental-pitched tone. The display shows <Device Type> CONNECTED and the Bluetooth icon turns from  to .



If the radio has the pairing record of the device and the connection fails, you hear a short, low-pitched tone. The display shows <Device Type> CON FAIL.

#### 2.14.6

### Radio Indications of Lost Bluetooth Connection

The radio shows  when the device has a Bluetooth connection. Below are the radio indications when the connection is interrupted.

The  starts blinking for up to 10 seconds. You hear a decremental-pitched tone. The display shows <Device Type> alternating with CON LOST.

If the Bluetooth device successfully re-connects before the Bluetooth Drop Timer expires, the display shows momentary <Device Type> CONNECTED, and  shows persistently, or if the Bluetooth device fails to re-connect within 10 seconds, the blinking  is replaced by a persistent .

#### 2.14.7

### Standard Pairing Feature



**NOTICE:** Bluetooth tones, Bluetooth menu, and preprogrammed buttons must be preprogrammed by a qualified radio technician. Check with your dealer or system administrator for more information.

Once a COTS headset is paired to your radio, it is always connected. Therefore the battery life of the accessory is aligned with the Talk time power consumption and not the Standby time consumption.

The Bluetooth Standard Pairing feature enables your Bluetooth enabled radio to search for other Bluetooth enabled and discoverable devices. Once the device is discovered, your radio automatically pairs with the device.

This feature also enables your Bluetooth enabled radio to be visible to other Bluetooth enabled devices and receive request to pair from other devices.

#### 2.14.7.1

### Searching and Pairing the Bluetooth Device

**Prerequisites:** Ensure the Bluetooth on your device is turned **on** and is set to **Discoverable** in order to enable your radio to detect your device in Bluetooth.

**When and where to use:** Bluetooth Search in Bluetooth Standard Pairing method is used to scan for other Bluetooth devices nearby. It is set to turn off by default.

The radio only search for HSP devices and Motorola Solutions MCW & OCW accessories. Radio filters out other profiles.

#### **Procedure:**

Press the preprogrammed **Bluetooth Inquiry On/Off** button, to enable the **Bluetooth Search** feature.

One of the following scenarios occurs:

- If successful, the display shows `SRCH ON` followed by `SRCH END` when the radio is pairing with a device found. The display shows `<Device Name> PAIRED` to indicate pairing is complete.
- If the feature fails to initiate or the radio fails to pair with any device, the display shows `SRCH END` when the search timer expires without pairing with any device. Repeat this step.

One of the following scenarios occurs:

- The radio continues to connect to the device. If the connecting process is successful, the radio sounds an incremental-pitched tone. The display shows `<Device Type>CONNECTED`, and the Bluetooth icon turns from `b` to `a`.
- If the device already has pairing records and the connecting process fails, the radio sounds a short, low-pitched tone. The display shows `<Device Type> CON FAIL`.
- If the connection fails within 6 seconds, you hear a decremental-pitched tone to indicate that the device is unpaired. The display shows `<Device Type> UNPAIRED`.

#### 2.14.7.2

### Turning On Bluetooth Visibility

**When and where to use:** Turning Bluetooth visibility on enables other Bluetooth devices to search for your radio. The visibility of the Bluetooth is set to turn off by default.

#### Procedure:

- a. Press and hold the preprogrammed **Bluetooth Inquiry On/ Off** button for three seconds to enable the Bluetooth visibility feature.

One of the following scenarios occurs:

- Keep holding the button although you hear a short, medium-pitched tone with the display shows momentary `VISIBLE`. This indicates the visibility is turned on successfully.<sup>2</sup>
- If the visibility fails to turn on, the display shows `VISIBLTYFAILED`.
- When the timer expires, the display shows `VISI OFF`.

#### 2.14.7.3

### Receiving Pairing Request from other Devices

**When and where to use:**

#### Procedure:

Turn on your radio Bluetooth Visible mode.

Your radio automatically accept the request and pair with any request received from other device.

#### 2.14.8

### Turning On the Bluetooth Audio

#### Procedure:

- Turning on the Bluetooth audio using the preprogrammed button:

---

<sup>2</sup> Releasing the preprogrammed button turns off the Visibility mode.



- a. Press the preprogrammed **Bluetooth Audio Reroute** button to route the audio from the radio to the headset.

You hear a short, medium-pitched tone. The display shows `HDSET ON`.

BT audio routing can be configured in CPS to route the audio to RSM or radio's internal speaker. The audio routes to the radio's speaker if RSM is not connected. Check with your dealer or system administrator for more information on the programming of this feature.



**NOTICE:** For BT PTT press, the active microphone can be configured in CPS to transmit from either the RSM, the radio microphone, or the BT headset. If the configured device is not available, audio transmission reverts to BT headset.

#### 2.14.9

### Turning Off the Bluetooth Audio

#### Procedure:

- Turning off the Bluetooth audio using the preprogrammed button:
  - a. Press the preprogrammed **Bluetooth Audio Reroute** button to route the audio from the headset to the radio.

You hear a short, medium-pitched tone. The display shows `SPKR ON`.

#### 2.14.10

### Adjusting the Volume of the Radio from Bluetooth Audio Device

**Prerequisites:** Ensure that the Bluetooth audio device is connected to the radio.

#### When and where to use:

Your radio can only control the volume of MCW and OCW Bluetooth enabled audio device. If the radio is paired with other Bluetooth enabled audio device, its volume is independent from the APX radio. In this case, the volume is only adjustable on the device.

#### Procedure:

Adjust volume up/down on the Bluetooth audio device.

The radio display shows `VOL XX` and sounds a short, medium-pitched tone.

#### 2.14.11

### Clearing All Bluetooth Devices Information

#### Procedure:

- Clearing all Bluetooth devices information using the preprogrammed **Bluetooth On/Off** button:
  - a. Long press the preprogrammed **Bluetooth On/Off** button.

You hear a short, medium-pitched tone. The display shows `PLS WAIT` to indicate clearing is in progress.

If successful, the display shows `ALL CLR`.

If unsuccessful, the radio sounds a short, low-pitched tone. The display shows `CLR FAIL`.

#### Postrequisites:



**NOTICE:** If Re-Pair Timer is set to infinite and you clear keys on the radio, you must clear keys on all previously paired devices as well. (Please see your accessories manual for further details.)

#### 2.14.12



### Pairing with LEX Handheld

**Prerequisites:** Ensure that Bluetooth feature of your radio is on and the Bluetooth tones are enabled.

**Procedure:**

- 1 Turn on the handheld and activate the Bluetooth feature.
- 2 Place the handheld close to the radio aligning the Bluetooth Pairing Location on the handheld with the Bluetooth Pairing Location on the radio.

If the pairing process is successful, you hear an incremental-pitched tone from the radio. The radio begins to connect to the handheld. If the connecting process is successful, you hear an incremental-pitched tone. The display shows `<Device Friendly Name> connected`, and

the Bluetooth icon turns from  to .

If unsuccessful, one of the following scenarios occur:

- You hear a short, low-pitched tone and the display shows `Bluetooth pairing failed` (if pairing fails).
- You hear a decremental-pitched tone and the display shows `<Device Friendly Name> unpaired` (if the connection fails within 6 seconds).
- You hear a short, low-pitched tone and the display shows `<Device Friendly Name> connect failed` (if the radio has the pairing record of the handheld and the connection fails).

Repeat this step to re-initiate the pairing process.



**NOTICE:** To unpair the handheld after a successful connection, follow the steps in [Viewing and Clearing the Bluetooth Device Information](#).

#### 2.14.13

### Responder Alert Sensors

Responder alert sensors allow the radio to send over-the-air (OTA) notification when the radio receives the holster sensor event.

To enable the feature, ensure that the GPS, Enhanced Data, and Bluetooth feature of your radio is on and the radio supports Bluetooth Low Energy (BT-LE).

You can disable the holster sensor temporarily or permanently. This feature allows you to prevent one or all events from being reported OTA.

This feature is enabled through Customer Programming Software (CPS) configuration. Check with your dealer or system administrator for more information on the programming of this feature.

#### 2.14.13.1

### Holster Sensor

Holster sensor monitors the state of the holster and allows the radio to send an over-the-air (OTA) notification whenever a gun or a taser is pulled out of the holster or put in the holster.

#### 2.14.13.2

### Disabling the Sensor

This feature gives you an option to avoid sending the sensor events to the system by disabling the sensors temporarily or permanently.



**NOTICE:** The feature is only applicable to holster sensor and weapon fired sensor. Vest pierced sensor cannot be disabled.

#### 2.14.13.2.1

### Disabling the Sensor Temporarily

#### Procedure:

- 1 Short-press the preprogrammed **Sensor** button to activate the sensor timer.

The following scenarios affect the sensor state:

- If a gun or taser is removed from the holster within the timer duration, the timer stops and switches the sensor to disabled state. A tone sounds and the radio displays `Sensor Disable`.



**NOTICE:** The radio enables the sensor only when all the guns or tasers are placed into the holster. A tone sounds and the radio displays `Sensor On` temporarily.

- If the timer expires without an event, a tone sounds, the radio switches the sensor to enabled state, and clears the sensor status from the display.
- If the preprogrammed **Sensor** button is long-pressed, the OTA sensor notification is enabled.

#### 2.14.13.2.2

### Disabling the Sensor Permanently

#### Procedure:

- 1 Long-press the preprogrammed **Sensor** button to permanently disable the sensors.

A tone sounds and the radio displays `Sensor Off`. While in this state, no events is reported over-the-air (OTA), regardless of how many times the gun is drawn, re-inserted or weapon is fired.

The radio generates a bad key tone if the sensor is not allowed to be disabled or there is no sensor connected to the radio when the preprogrammed button or menu select button is pressed.

- 2 Long-press the preprogrammed **Sensor** button again to enable the OTA Sensor notification. A tone sounds, and the radio displays `SNSR OFF`.

#### 2.15

### Over-the-Air Programming (POP 25, ASTRO 25, and ASTRO Conventional)

This feature enables configuration data and firmware to be upgraded to your radio over-the-air. Full use of the radio is retained during the data transfer without interrupting communication. For ASTRO 25

and ASTRO Conventional, the upgrade pauses to give priorities to voice call, and continues after the voice call ended. For Wi-Fi, the upgrade process runs concurrently with voice calls.

Once a configuration upgrade is downloaded to your radio, you can install new changes immediately or delay changes to be installed on the radio when it is being powered up.



**NOTICE:** This feature must be preprogrammed by a qualified radio technician. Check with your dealer or system administrator for more information.

## 2.16

### Voice Announcement

This feature enables the radio to audibly indicate the current feature mode, zone, or channel the user has just been assigned to. This feature is useful when you have difficulty reading the content on the display.

If preprogrammed by a qualified radio technician, the following occurs:

- Channel Announcement is played in the following scenarios:
  - When the radio powers up.
  - When you change to a new zone.
  - When you change to a new channel.
  - When you press a preprogrammed button or switch.
- Feature Voice Announcement is played when you change the state of a feature. Various features can have Voice Announcement assigned to indicate the on/off state of the features.

The available voice announcement priority options are:

#### High

Voice announcement is enabled even when the radio is receiving calls.

#### Low

Voice announcement is disabled when the radio is receiving calls.

## 2.17

### Site Selectable Alerts (ASTRO 25)

A Site Selectable Alert (SSA) is an Intelligent Lighting indicator together with audio alert sent to radios at a site or a few sites to notify the users when there is a special situation that they need to be aware of.

Your radio supports up to 250 site aliases. Only authorized radios are enabled to send SSA. Upon the activation of a SSA, the receiving radios display the alert alias and generate the periodic alert tone.



**NOTICE:** Alert alias, alert tone, and alert period can be preprogrammed. Alert period is the duration for the radio to repeat the alert tone. An interval of 5 seconds might impact the battery life of the radio. Check with your dealer or system administrator for more details.

When mixing SSA with received voice audio, the SSA alert is reduced in volume to ensure that the voice message is still heard clearly. Therefore, it is important that the SSA audio files are created with clear loud audio to ensure they can still be heard clearly when played at reduced levels.

## 2.18

### Utilities

This chapter explains the operations of the utility functions available in your radio.

#### 2.18.1

### Using the Flip Display

**When and where to use:** This feature allows you to flip the content of the top display upside down. It is particularly useful when you would like to read the top display while the radio is still in the carry holder attached to your belt.

**Procedure:**

To flip the display, press and hold the preprogrammed **Light/Flip** button.

#### 2.18.2

### Selecting a Basic Zone Bank

**Prerequisites:** The Basic Zone Select feature must to be preprogrammed to the **3-position A-B-C** switch, while the Basic Zone Bank feature must be preprogrammed to any **side** button or **Top (Orange)** button before you can use this feature.

**When and where to use:** This feature allows twice as many zones to be accessed from a switch, doubling the amount of switch positions.

**Procedure:**

- 1 Use the preprogrammed **Basic Zone Bank** button to toggle the position between Bank 1 and Bank 2.

The top display shows the status icons (A, B, C, D, E, or F) or the zone name based on the bank and switch position selected.



**NOTICE:** See the [Basic Zone Bank 1](#) and [Basic Zone Bank 2](#) icons for more information on the status icons.

#### 2.18.3

### Selecting the Power Level

**Prerequisites:**



**NOTICE:** This feature must be preprogrammed by a qualified radio technician.

**When and where to use:** This feature enables you to reduce the transmit power level for specific case that requires a lower power level. You can select the power level at which your radio transmits. The radio always turns on to the default setting. These reduced transmit power level settings do not affect the receiving performance of your radio, nor diminish the overall quality of the audio and data functionality of the radio given the following conditions.

Power level **Low** enables a shorter transmitting distance and to conserve power. Power level **High** enables a longer transmitting distance.

**Procedure:**

- Use the preprogrammed **Transmit Power Level** switch to toggle the power level between low and high power.

The display shows **LOW PWR** and the low power icon or the display shows **HIGH PWR** and the high power icon.

#### 2.18.4

### Controlling the Display Backlight

**When and where to use:** You can enable or disable the radio display backlight as needed, if poor light conditions make the display difficult to read.



**NOTICE:**

The backlight remains on for a preprogrammed time before it automatically turns off completely or returns to the minimum backlight level.

**Procedure:**

Perform one of the following actions.

- To toggle the backlight on or off, press the preprogrammed **Light/Flip** button.
- To turn the backlight on, press any programmable radio controls or buttons.

#### 2.18.5

### Locking and Unlocking the Controls

**When and where to use:** You can lock the programmable buttons, switches, and rotary knobs of your radio to avoid inadvertent entry. Check with your dealer or qualified technician for best selection to suit your usage.

**Procedure:**

- 1 Toggle the preprogrammed **Keypad/Control Lock** button or switch to on.  
The display shows **CTRL LCK**.
- 2 Toggle again to unlock the controls.

#### 2.18.6

### Turning Voice Mute On or Off

**When and where to use:** You can enable and disable voice transmission, if needed.

**Procedure:**

- Turning Voice Mute off or on using the preprogrammed **Voice Mute** button:
  - a. To turn the feature off or on, press the preprogrammed **Voice Mute** button.

The display shows momentary **VMUT OFF**, and you hear a short tone, indicating that the feature is disabled or the display shows momentary **VMUT ON**, and you hear a short tone, indicating that the feature is enabled.

### 2.18.7

## Using the Time-Out Timer

**When and where to use:** This feature turns off the transmitter of your radio. You cannot transmit longer than the preset timer setting.

If you attempt to do so, the radio automatically stops your transmission, and you hear a talk-prohibit tone.

The timer is defaulted at 60 seconds, but it can be preprogrammed from 15 to 465 seconds, in 15-second intervals, or it can be disabled entirely for each radio mode, by a qualified radio technician.



**NOTICE:** You hear a brief, low-pitched, warning tone four seconds before the transmission times out.

### Procedure:

- 1 Hold down the **PTT** button longer than the preprogrammed time.  
You hear a continuous talk prohibit tone. After four seconds, the transmission is cut-off and the LED goes out.
- 2 Release the **PTT** button.  
The timer resets.
- 3 To re-transmit, press the **PTT** button.  
The time-out timer restarts and the LED lights up solid red.

### 2.18.8

## Using Conventional Squelch Operation Features

This feature filters out unwanted calls with low signal strength or channels that have a higher than normal background noise.

### 2.18.8.1

## Analog Options

Tone Private Line, Digital Private-Line, and carrier squelch can be available (preprogrammed) per channel.

Option	Result
Carrier squelch	You hear all traffic on a channel.
Tone Private Line or Digital Private-Line	The radio responds only to your messages.

### 2.18.8.2

## Digital Options

One or more of the following options may be preprogrammed in your radio. Check with your dealer or system administrator for more information.

Option	Result
Digital Carrier-Operated Squelch	You hear all digital traffic.
Normal Squelch	You hear any digital traffic having the correct network access code.

Option	Result
Selective Switch	You hear any digital traffic having the correct network access code and correct talkgroup.

### 2.18.9

## Using the PL Defeat Feature

This feature allows you to override any coded squelch that preprogrammed to a channel. The radio also unmutes to any digital activity on a digital channel. When this feature is active, the Carrier Squelch status indicator is displayed.

### Procedure:

Place the preprogrammed **PL Defeat** switch in the PL Defeat position.

One of the following occurs:

- The radio plays the active transmission on the channel.
- The radio is muted if no activity is present.

### 2.18.10

## Digital PTT ID Support

This feature allows you to see the radio ID (number) of the radio from whom you are currently receiving a transmission. This ID, consisting up to a maximum of eight characters, can be viewed by both the receiving radio and the dispatcher.

The ID number of your radio is also automatically sent every time the **PTT** button is pressed. This is a per-channel feature. For digital voice transmissions, the ID of your radio is sent continuously during the voice message.

### 2.18.11

## Smart PTT (Conventional Only)

Smart PTT is a per-personality, programmable feature used to keep radio users from talking over other radio conversations. When Smart PTT is enabled in your radio, you cannot transmit on an active channel.

The following table shows the variations of Smart PTT.

Mode	Description
Transmit Inhibit on Busy Channel with Carrier	You cannot transmit if traffic is detected on the channel.
Transmit Inhibit on Busy Channel with Wrong Squelch Code	You cannot transmit on an active channel with a squelch code or (if secure-equipped) encryption key other than your own. If the PL code is the same as yours, the transmission is not prevented.
Quick-Key Override	Your radio must be preprogrammed to allow you to use Quick-Key Override. This feature works with either one of the two above variations. You can override the transmit-inhibit state



Mode	Description
	by quick-keying the radio (press <b>PTT</b> button twice within the preprogrammed time limit).

### 2.18.12

## Transmit Inhibit

This feature is available for APCO 25 trunking, Type II trunking and Conventional operations for all APX radios.

When Transmit Inhibit feature is enabled, the radio stops all transmission including voice and data. The radio can receive messages but is not able to reply the acknowledgment request of the received message.

User can physically control the transmission of the radio especially during operation in hazardous environments with this feature. An environment is considered hazardous when the power emitted by the radio power amplifier could initiate an explosion or other dangerous reactions.

When the Transmit Inhibit feature is disabled, the radio functions according to its normal operations.

The radio sounds alert tone when user enters or exits this feature and also when **PTT** is pressed.



**NOTICE:** Acknowledgment of any messages required from the radio is not transmitted if the Transmit Inhibition is enabled.

### 2.18.12.1

## Enabling Transmit Inhibition

### Procedure:

- 1 Press the **Transmit Inhibit** programmable button.



**NOTICE:** If the user has disabled TX Inhibit using the menu and then moves the switch to the position where TX Inhibit is enabled, the new value overwrites the menu value.

The display shows `Tx inhibit on`. You hear a sequence of short, low-high tones to indicate transmission is inhibited.

Pressing **PTT** triggers the radio sounds a constant short, low-pitched tone (reject tone).



**NOTICE:** The status of the Transmit Inhibit does not change after the radio powers up.

### 2.18.12.2

## Disabling Transmit Inhibition

### Procedure:

- 1 Press the Transmit Inhibit programmable button.



**NOTICE:** If the user has disabled TX Inhibit using the softkey and then moves the switch to the position where TX Inhibit is enabled, the new value overwrites the menu value.

The display shows `Tx inhibit off`. You hear a sequence of short, high-low tone (Transmit Inhibit Off tone) to indicate transmission is back to normal operation.

### 2.18.13

## Instant Recall

This feature allows the user to save the last received call and playback the recorded call.

The feature buffers all incoming audio over the air and stored when the audio is saved.

### 2.18.13.1

## Saving and Playback Calls

### When and where to use:

#### Procedure:

- Saving the recorded calls using the preprogrammed **Record Playback** button:
  - a. Long press the preprogrammed **Record Playback** button to save the recorded calls.

Radio displays `Audio Saved` momentarily.

Radio plays the saved call automatically if call saving is successful.

A tone sounds if call saving is not successful.

- Playback the saved calls using the preprogrammed **Record Playback** button:
  - a. Short press the preprogrammed **Record Playback** button to playback the saved calls.
  - b. Short press the preprogrammed **Record Playback** button again to skip to the next saved call. If there is only a single saved call, the playback skips to the end of the call.

Radio auto playback the most recent incoming call followed by saved calls in chronological order.

Radio displays the playback status.



#### **NOTICE:**

Received call overwrites the ongoing record playback. User can short press the programmable button within three seconds to continue the playback and ignore the receiving call.

User can short press the programmable button to trigger playback when the radio is receiving call to overwrite the receiving call.

Playback can be halted by any tone and button press except for specific buttons. Check with your dealer or system administrator for more information.

## Accessories

Not all accessories are FCC certified to operate with all radio models and/or bandsplits. Refer to the radio price pages for a list of FCC certified accessories or contact your sales representative for accessory compatibility.

Visit <http://www.motorolasolutions.com> to know more about the accessories supported by this radio.



**NOTICE:** GPS only antenna is used in either a single band UHF or 700/800 application where the Public Safety Microphone (PSM) is used with the corresponding PSM antenna. This antenna is only for GPS reception and cannot be used for receive/transmit operation at UHF, VHF, or 700/800. This antenna is never to be used on the PSM.

# Maritime Radio Use in the VHF Frequency Range

## 4.1 Special Channel Assignments

### 4.1.1 Emergency Channel

If you are in imminent and grave danger at sea and require emergency assistance, use VHF Channel 16 to send a distress call to nearby vessels and the United States Coast Guard. Transmit the following information, in this order:

- 1 "MAYDAY, MAYDAY, MAYDAY."
- 2 "THIS IS \_\_\_\_\_, CALL SIGN \_\_\_\_\_." State the name of the vessel in distress 3 times, followed by the call sign or other identification of the vessel, stated 3 times.
- 3 Repeat "MAYDAY" and the name of the vessel.
- 4 "WE ARE LOCATED AT \_\_\_\_\_." State the position of the vessel in distress, using any information that will help responders to locate you, e.g.:
  - latitude and longitude
  - bearing (state whether you are using true or magnetic north)
  - distance to a well-known landmark
  - vessel course, speed or destination
- 5 State the nature of the distress.
- 6 Specify what kind of assistance you need.
- 7 State the number of persons on board and the number needing medical attention, if any.
- 8 Mention any other information that would be helpful to responders, such as type of vessel, vessel length and/or tonnage, hull color, etc.
- 9 "OVER."
- 10 Wait for a response.
- 11 If you do not receive an immediate response, remain by the radio and repeat the transmission at intervals until you receive a response. Be prepared to follow any instructions given to you.

### 4.1.2 Non-Commercial Call Channel

For non-commercial transmissions, such as fishing reports, rendezvous arrangements, repair scheduling, or berthing information, use **VHF Channel 9**.

## 4.2 Operating Frequency Requirements

A radio designated for shipboard use must comply with Federal Communications Commission Rule Part 80 as follows:

- on ships subject to Part II of Title III of the Communications Act, the radio must be capable of operating on the 156.800 MHz frequency.
- on ships subject to the Safety Convention, the radio must be capable of operating:
  - in the simplex mode on the ship station transmitting frequencies specified in the 156.025–157.425 MHz frequency band, and
  - in the semiduplex mode on the two frequency channels specified in the table below.



**NOTICE:**

Simplex channels 3, 21, 23, 61, 64, 81, 82, and 83 cannot be lawfully used by the general public in US waters.

Additional information about operating requirements in the Maritime Services can be obtained from the full text of FCC Rule Part 80 and from the US Coast Guard.

Table 3: VHF Marine Channel List

Channel Number	Frequency (MHz)	
	Transmit	Receive
1	156.050	160.650
2	156.100	160.700
*	156.150	160.750
4	156.200	160.800
5	156.250	160.850
6	156.300	–
7	156.350	160.950
8	156.400	–
9	156.450	156.450
10	156.500	156.500
11	156.550	156.550
12	156.600	156.600
13**	156.650	156.650
14	156.700	156.700
15**	156.750	156.750
16	156.800	156.800
17**	156.850	156.850
18	156.900	161.500
19	156.950	161.550
20	157.000	161.600
*	157.050	161.650
22	157.100	161.700
*	157.150	161.750
24	157.200	161.800
25	157.250	161.850

68012002071-KK  
 Maritime Radio Use in the VHF Frequency Range

26	157.300	161.900
27	157.350	161.950
28	157.400	162.000
60	156.025	160.625
*	156.075	160.675
62	156.125	160.725
63	156.175	160.775
*	156.225	160.825
65	156.275	160.875
66	156.325	160.925
67**	156.375	156.375
68	156.425	156.425
69	156.475	156.475
71	156.575	156.575
72	156.625	—
73	156.675	156.675
74	156.725	156.725
75	***	***
76	***	***
77**	156.875	—
78	156.925	161.525
79	156.975	161.575
80	157.025	161.625
*	157.075	161.675
*	157.125	161.725
*	157.175	161.775
84	157.225	161.825
85	157.275	161.875
86	157.325	161.925
87	157.375	161.975
88	157.425	162.025



**NOTICE:**

\* Simplex channels 3, 21, 23, 61, 64, 81, 82, and 83 cannot be **lawfully used** by the general public in US waters.

\*\* Low power (1 W) only.

\*\*\* Guard band.



**NOTICE:** A – in the Receive column indicates that the channel is transmit only.

4.3

## Declaration of Compliance for the Use of Distress and Safety Frequencies

The radio equipment does not employ a modulation other than the internationally adopted modulation for maritime use when it operates on the distress and safety frequencies specified in RSS-182 Section 7.3.

4.4

## Technical Parameters for Interfacing External Data Sources

	<b>RS232</b>	<b>USB</b>	<b>SB9600</b>
<b>Input Voltage (Volts Peak-to-peak)</b>	18 V	3.6 V	5 V
<b>Max Data Rate</b>	115 Kbps	12 Mbps	9.6 Kbps
<b>Impedance</b>	5000 $\Omega$	90 $\Omega$	120 $\Omega$

# Glossary

This glossary contains an alphabetical listing of terms and their definitions that are applicable to portable and mobile subscriber radio products.

## **ACK**

Acknowledgment of communication.

## **Active Channel**

A channel that has traffic on it.

## **Analog Signal**

An RF signal that has a continuous nature rather than a pulsed or discrete nature.

## **ARS**

Automatic Registration Service

## **ASTRO 25**

Motorola Solutions standard for wireless digital trunked communications.

## **ASTRO conventional**

Motorola Solutions standard for wireless analog or digital conventional communications.

## **Autoscan**

A feature that allows the radio to automatically scan the members of a scan list.

## **Bluetooth**

Bluetooth is an open wireless technology standard for exchanging data over short distances from fixed and mobile devices with high levels of security.

## **Bluetooth Pairing**

Bluetooth pairing occurs when two bluetooth devices exchanged a passkey to form a paired Bluetooth wireless connection.

## **Call Alert**

Privately paging an individual by sending an audible tone.

## **Carrier Squelch**

Feature that responds to the presence of an RF carrier by opening or unmuting (turning on) a receiver audio circuit. A squelch circuit silences the radio when no signal is being received so that the user does not have to listen to “noise.”

## **Central Controller**



A software-controlled, computer-driven device that receives and generates data for the trunked radios assigned to it. It Monitors and directs the operations of the trunked repeaters.

### **Channel**

A group of characteristics, such as transmit/receive frequency pairs, radio parameters, and encryption encoding.

### **Control Channel**

In a trunking system, one of the channels that is used to provide a continuous, two-way/data-communications path between the central controller and all radios on the system.

### **Conventional**

Typically refers to radio-to-radio communications, sometimes through a repeater. Frequencies are shared with other users without the aid of a central controller to assign communications channels.

### **Conventional Scan List**

A scan list that includes only conventional channels.

### **COTS**

Commercial Off-The-Shelf.

### **Cursor**

A visual tracking marker (a blinking line) that indicates a location on a display.

### **Digital Private Line**

A type of digital communications that utilizes privacy call, as well as memory channel and busy channel lock out to enhance communication efficiency.

### **Digital Signal**

An RF signal that has a pulsed, or discrete, nature, rather than a continuous nature.

### **Dispatcher**

An individual who has radio-system management duties and responsibilities.

### **Digital Signal Processor**

A microcontroller specifically designed for performing the mathematics involved in manipulating analog information, such as sound, that has been converted into a digital form. DSP also implies the use of a data compression technique.

### **Dynamic Regrouping**

A feature that allows the dispatcher to temporarily reassign selected radios to a single special channel so they can communicate with each other.

### **Failsoft**

A backup system that allows communication in a non-trunked, conventional mode if the trunked system fails.

### **FCC**

Federal Communications Commission.

## **Hang up**

Disconnect.

## **IV&D**

Integrated Voice and Data.

**Key Variable Loader (KVL)** A portable, handheld, rugged device used to transfer encryption keys to a target device. Encryption keys can be entered manually by the KVL user, auto-generated by the KVL, obtained from or shared with another KVL, or downloaded from a Key Management Facility (KMF).

## **Liquid-Crystal Display (LCD)**

An LCD uses two sheets of polarizing material with a liquid-crystal solution between them. An electric current passed through the liquid causes the crystals to align so that light cannot pass through them.

## **Light Emitting Diode (LED)**

An electronic device that lights up when electricity is passed through it.

## **Li-Ion**

Lithium ion.

## **Man Down**

A life-saving feature that senses the radio user may be in trouble by monitoring the whether the radio is in a vertical or horizontal position or whether the radio is motionless. When this feature is triggered, the radio alerts the user with audio and visual alerts. It can also trigger Emergency Alarm the Post-Alert Timer is not cancelled.

## **MCW**

Mission Critical Wireless.

## **MDC**

Motorola Solutions Digital Communications.

## **Monitor**

Check channel activity by pressing the Monitor button. If the channel is clear, you hear static. If the channel is in use, you hear conversation. It also serves as a way to check the volume level of the radio, since the radio "opens the squelch" when the monitor button is pressed.

## **Multi-System Talkgroup Scan List**

A scan list that can include both talkgroups (trunked) and channels (conventional).

## **Network Access Code**

Network Access Code (NAC) operates on digital channels to reduce voice channel interference between adjacent systems and sites.

## **NiMH**

Nickel-metal-hydride.

### **Non-tactical/revert**

The user will talk on a preprogrammed emergency channel. The emergency alarm is sent out on this same channel.

### **OCW**

Operation Critical Wireless.

### **Over-The-Air Rekeying**

Allows the dispatcher to remotely reprogram the encryption keys in the radio.

### **Page**

A one-way alert with audio and/or display messages.

### **Personality**

A set of unique features specific to a radio.

### **Preprogrammed**

A software feature that has been activated by a qualified radio technician.

### **Private (Conversation) Call**

A feature that lets you have a private conversation with another radio user in the group.

### **Private Line (PL)**

A sub-audible tone that is transmitted such that only receivers decoding the tone receives it.

### **Programmable**

A radio control that can have a radio feature assigned to it.

### **Push-to-Talk**

PTT-The switch or button usually located on the left side of the radio which, when pressed, causes the radio to transmit. When the PTT is released, the unit returns to receive operation.

### **Radio Frequency**

RF-The portion of the electromagnetic spectrum between audio sound and infrared light (approximately 10 kHz to 10 GHz).

### **Repeater**

Remote transmit/receive facility that re-transmits received signals in order to improve communications range and coverage (conventional operation).

### **selective switch**

Any digital P25 traffic having the correct Network Access Code and the correct talkgroup.

### **Squelch**

Muting of audio circuits when received signal levels fall below a pre-determined value. With carrier squelch, all channel activity that exceeds the preset squelch level can be heard.

### **Synchronous Serial Interface (SSI)**

DSP interface to peripherals that consists of a clock signal line, a frame synchronization signal line, and a data line.

### **Standby**

An operating condition whereby the radio's speaker is muted but still continues to receive data.

### **Status Calls**

Pre-defined text messages that allow the user to send a conditional message without talking.

### **Tactical/non-revert**

The user will talk on the channel that was selected before the radio entered the emergency state.

### **TalkAround**

Bypassing a repeater and talking directly to another unit for local unit-to-unit communications.

### **Talkgroup**

An organization or group of radio users who communicate with each other using the same communications path.

### **Trunking**

The automatic sharing of communications paths between a large number of users. Allows users to share a smaller number of frequencies because a repeater or communications path is assigned to a talkgroup for the duration of a conversation.

### **Trunking Priority Monitor scan list**

A scan list that includes talkgroups that are all from the same trunking system.

### **USK**

Unique shadow key.

### **VRS**

Vehicular Repeater System.

### **Zone**

A grouping of channels.

# Limited Warranty

## 6.1

### MOTOROLA SOLUTIONS COMMUNICATION PRODUCTS

## 6.2

### I. WHAT THIS WARRANTY COVERS AND FOR HOW LONG:

MOTOROLA SOLUTIONS, INC. (“MOTOROLA”) warrants the MOTOROLA SOLUTIONS manufactured Communication Products listed below (“Product”) against defects in material and workmanship under normal use and service for a period of time from the date of purchase as scheduled below:

ASTRO Portable Units	One (1) Year
Product Accessories	One (1) Year

For LACR region:

ASTRO APX 7000XE Portable Units	Three (3) Years
Product Accessories	One (1) Year

MOTOROLA SOLUTIONS, at its option, will at no charge either repair the Product (with new or reconditioned parts), replace it (with a new or reconditioned Product), or refund the purchase price of the Product during the warranty period provided it is returned in accordance with the terms of this warranty. Replaced parts or boards are warranted for the balance of the original applicable warranty period. All replaced parts of Product shall become the property of MOTOROLA SOLUTIONS.

This express limited warranty is extended by MOTOROLA SOLUTIONS to the original end user purchaser only and is not assignable or transferable to any other party. This is the complete warranty for the Product manufactured by MOTOROLA SOLUTIONS. MOTOROLA SOLUTIONS assumes no obligations or liability for additions or modifications to this warranty unless made in writing and signed by an officer of MOTOROLA SOLUTIONS.

Unless made in a separate agreement between MOTOROLA SOLUTIONS and the original end user purchaser, MOTOROLA SOLUTIONS does not warrant the installation, maintenance or service of the Product.

MOTOROLA SOLUTIONS cannot be responsible in any way for any ancillary equipment not furnished by MOTOROLA SOLUTIONS which is attached to or used in connection with the Product, or for operation of the Product with any ancillary equipment, and all such equipment is expressly excluded from this warranty. Because each system which may use the Product is unique, MOTOROLA SOLUTIONS disclaims liability for range, coverage, or operation of the system as a whole under this warranty.

MOTOROLA SOLUTIONS offers the following optional extended service contracts.

#### **DEVICE MANAGED SERVICES (DMS) ACCIDENTAL DAMAGE**

Provides for extended hardware repair coverage INCLUDING CHEMICAL, LIQUID, FIRE, AND OTHER PHYSICAL DAMAGE. Accidental damage coverage is available in conjunction with MOTOROLA SOLUTIONS'S standard Commercial Warranty and starts from the FIRST DAY the radio is put into use. Service performed under this plan consists of repair or replacement of the covered

equipment as set forth in the terms and conditions. Repairs will be made only at the designated MOTOROLA SOLUTIONS repair depot. Local services are not included. MOTOROLA SOLUTIONS will pay the inbound shipping charges only with use of the MOTOROLA SOLUTIONS designated delivery service. MOTOROLA SOLUTIONS will pay for outbound shipping via MOTOROLA SOLUTIONS'S normal shipping methods.

#### **DEVICE MANAGED SERVICES (DMS) STANDARD HARDWARE**

Provides extended hardware normal wear and tear repair coverage beginning AFTER MOTOROLA SOLUTIONS'S standard Commercial Warranty period expires. Service performed under this plan consists of repair of the covered equipment as set forth in the terms and conditions. Repairs will be made only at the designated MOTOROLA SOLUTIONS repair depot. Local services are not included. MOTOROLA SOLUTIONS will pay for outbound shipping via MOTOROLA SOLUTIONS'S normal shipping methods.

### 6.3

## **II. GENERAL PROVISIONS:**

This warranty sets forth the full extent of MOTOROLA SOLUTIONS'S responsibilities regarding the Product. Repair, replacement or refund of the purchase price, at MOTOROLA SOLUTIONS's option, is the exclusive remedy. THIS WARRANTY IS GIVEN IN LIEU OF ALL OTHER EXPRESS WARRANTIES. IMPLIED WARRANTIES, INCLUDING WITHOUT LIMITATION, IMPLIED WARRANTIES OF MERCHANTABILITY AND FITNESS FOR A PARTICULAR PURPOSE, ARE LIMITED TO THE DURATION OF THIS LIMITED WARRANTY. IN NO EVENT SHALL MOTOROLA SOLUTIONS BE LIABLE FOR DAMAGES IN EXCESS OF THE PURCHASE PRICE OF THE PRODUCT, FOR ANY LOSS OF USE, LOSS OF TIME, INCONVENIENCE, COMMERCIAL LOSS, LOST PROFITS OR SAVINGS OR OTHER INCIDENTAL, SPECIAL OR CONSEQUENTIAL DAMAGES ARISING OUT OF THE USE OR INABILITY TO USE SUCH PRODUCT, TO THE FULL EXTENT SUCH MAY BE DISCLAIMED BY LAW.

### 6.4

## **III. STATE LAW RIGHTS:**

SOME STATES DO NOT ALLOW THE EXCLUSION OR LIMITATION OF INCIDENTAL OR CONSEQUENTIAL DAMAGES OR LIMITATION ON HOW LONG AN IMPLIED WARRANTY LASTS, SO THE ABOVE LIMITATION OR EXCLUSIONS MAY NOT APPLY.

This warranty gives specific legal rights, and there may be other rights which may vary from state to state.

### 6.5

## **IV. HOW TO GET WARRANTY SERVICE:**

You must provide proof of purchase (bearing the date of purchase and Product item serial number) in order to receive warranty service and, also, deliver or send the Product item, transportation and insurance prepaid, to an authorized warranty service location. Warranty service will be provided by MOTOROLA SOLUTIONS through one of its authorized warranty service locations. If you first contact the company which sold you the Product (e.g., dealer or communication service provider), it can facilitate your obtaining warranty service. You can also call MOTOROLA SOLUTIONS at 1-800-927-2744 US/Canada.

### 6.6

## **V. WHAT THIS WARRANTY DOES NOT COVER:**

- 1 Defects or damage resulting from use of the Product in other than its normal and customary manner.

- 2 Defects or damage from misuse, accident, water, or neglect.
- 3 Defects or damage from improper testing, operation, maintenance, installation, alteration, modification, or adjustment.
- 4 Breakage or damage to antennas unless caused directly by defects in material workmanship.
- 5 A Product subjected to unauthorized Product modifications, disassembles or repairs (including, without limitation, the addition to the Product of non-MOTOROLA SOLUTIONS supplied equipment) which adversely affect performance of the Product or interfere with MOTOROLA SOLUTIONS's normal warranty inspection and testing of the Product to verify any warranty claim.
- 6 Product which has had the serial number removed or made illegible.
- 7 Rechargeable batteries if:
  - any of the seals on the battery enclosure of cells are broken or show evidence of tampering.
  - the damage or defect is caused by charging or using the battery in equipment or service other than the Product for which it is specified.
- 8 Freight costs to the repair depot.
- 9 A Product which, due to illegal or unauthorized alteration of the software/firmware in the Product, does not function in accordance with MOTOROLA SOLUTIONS's published specifications or the FCC certification labeling in effect for the Product at the time the Product was initially distributed from MOTOROLA SOLUTIONS.
- 10 Scratches or other cosmetic damage to Product surfaces that does not affect the operation of the Product.
- 11 Normal and customary wear and tear.

#### 6.7

### **VI. PATENT AND SOFTWARE PROVISIONS:**

MOTOROLA SOLUTIONS will defend, at its own expense, any suit brought against the end user purchaser to the extent that it is based on a claim that the Product or parts infringe a United States patent, and MOTOROLA SOLUTIONS will pay those costs and damages finally awarded against the end user purchaser in any such suit which are attributable to any such claim, but such defense and payments are conditioned on the following:

- 1 that MOTOROLA SOLUTIONS will be notified promptly in writing by such purchaser of any notice of such claim,
- 2 that MOTOROLA SOLUTIONS will have sole control of the defense of such suit and all negotiations for its settlement or compromise, and
- 3 should the Product or parts become, or in MOTOROLA SOLUTIONS's opinion be likely to become, the subject of a claim of infringement of a United States patent, that such purchaser will permit MOTOROLA SOLUTIONS, at its option and expense, either to procure for such purchaser the right to continue using the Product or parts or to replace or modify the same so that it becomes non-infringing or to grant such purchaser a credit for the Product or parts as depreciated and accept its return. The depreciation will be an equal amount per year over the lifetime of the Product or parts as established by MOTOROLA SOLUTIONS.

MOTOROLA SOLUTIONS will have no liability with respect to any claim of patent infringement which is based upon the combination of the Product or parts furnished hereunder with software, apparatus or devices not furnished by MOTOROLA SOLUTIONS, nor will MOTOROLA SOLUTIONS have any liability for the use of ancillary equipment or software not furnished by MOTOROLA SOLUTIONS which is attached to or used in connection with the Product. The foregoing states the entire liability of MOTOROLA SOLUTIONS with respect to infringement of patents by the Product or any parts thereof.

Laws in the United States and other countries preserve for MOTOROLA SOLUTIONS certain exclusive rights for copyrighted MOTOROLA SOLUTIONS software such as the exclusive rights to reproduce in

copies and distribute copies of such MOTOROLA SOLUTIONS software. MOTOROLA SOLUTIONS software may be used in only the Product in which the software was originally embodied and such software in such Product may not be replaced, copied, distributed, modified in any way, or used to produce any derivative thereof. No other use including, without limitation, alteration, modification, reproduction, distribution, or reverse engineering of such MOTOROLA SOLUTIONS software or exercise of rights in such MOTOROLA SOLUTIONS software is permitted. No license is granted by implication, estoppel or otherwise under MOTOROLA SOLUTIONS patent rights or copyrights.

6.8

## **VII. GOVERNING LAW:**

This Warranty is governed by the laws of the State of Illinois, U.S.A.

6.9

## **VIII. For Australia Only**

This warranty is given by Motorola Solutions Australia Pty Limited (ABN 16 004 742 312) of Tally Ho Business Park, 10 Wesley Court, Burwood East, Victoria.

Our goods come with guarantees that cannot be excluded under the Australia Consumer Law. You are entitled to a replacement or refund for a major failure and compensation for any other reasonably foreseeable loss or damage. You are also entitled to have the goods repaired or replaced if the goods fail to be of acceptable quality and the failure does not amount to a major failure.

Motorola Solutions Australia's limited warranty above is in addition to any rights and remedies you may have under the Australian Consumer Law. If you have any queries, please call Motorola Solutions Australia at 1800 457 439. You may also visit our website: [http://www.motorolasolutions.com/XA-EN/Pages/Contact\\_Us](http://www.motorolasolutions.com/XA-EN/Pages/Contact_Us) for the most updated warranty terms.