

# ST7500 Feature User Guide

Mobile Release 2023.3

**NOVEMBER 2023**

© 2023 Motorola Solutions, Inc. All Rights Reserved.



MN004519A01-AR

# Contents

<b>List of Figures</b> .....	<b>9</b>
<b>List of Tables</b> .....	<b>10</b>
<b>Safety Information</b> .....	<b>11</b>
<b>Applying for Canadian License</b> .....	<b>12</b>
<b>Intellectual Property and Regulatory Notices</b> .....	<b>13</b>
<b>Chapter 1: General Information</b> .....	<b>14</b>
1.1 Icon Conventions.....	14
1.2 Using this Guide.....	14
1.3 Feature and Service Availability.....	14
<b>Chapter 2: Getting Started</b> .....	<b>15</b>
2.1 Before Power On.....	15
2.1.1 Replacing Antenna.....	15
2.1.2 Removing and Attaching the Battery Cover.....	15
2.1.3 Installing the SIM Card.....	17
2.1.4 Removing the SIM Card.....	19
2.1.5 CRYPTR Micro or Micro HSM Card.....	21
2.1.5.1 Installing the CRYPTR Micro or Micro HSM Card.....	21
2.1.5.2 Removing the CRYPTR Micro or Micro HSM Card.....	23
2.1.6 Installing the Battery.....	23
2.1.7 Removing the Battery.....	24
2.1.8 Charging the Battery.....	24
2.1.9 Battery Charging Indications.....	25
2.1.10 Low Battery Indication.....	26
2.2 ST7500 Controls and Indicators.....	26
2.3 Powering On the Radio.....	28
2.4 Writing Text.....	29
2.4.1 Text Entry Icons.....	29
2.4.2 Keys Usage.....	29
2.5 PIN Code Authentication.....	30
2.5.1 Unlocking Your Radio.....	30
2.5.2 Unblocking Your Radio.....	31
2.6 Display.....	31
2.6.1 Configurable Idle Screen.....	31
2.7 Status Icons.....	32
2.8 Holding Your Radio.....	35

2.9 High or Low Audio Toggle.....	36
2.9.1 Using High Audio.....	36
2.9.2 Using Low Audio.....	36
2.10 During a Call.....	36
2.11 Selecting Talkgroups.....	37
2.12 Entering TMO or DMO Mode.....	37
2.13 Covert Solution.....	37
2.13.1 Sending Mission Critical Communication Tones.....	38
2.14 Over The Air Programming.....	39
2.15 One-Touch Buttons.....	40
<b>Chapter 3: Modes.....</b>	<b>42</b>
3.1 Trunked Mode Operation.....	42
3.1.1 Entering TMO Mode.....	42
3.1.2 Making Group Calls in TMO.....	42
3.1.3 Receiving Group Calls in Idle.....	43
3.1.4 Receiving Group Calls during Ongoing Group Calls.....	43
3.1.5 D-PTT Preempt Group Call.....	43
3.1.5.1 Preempting Group Calls.....	43
3.1.6 Dynamic Group Number Assignment (DGNA).....	44
3.1.6.1 DGNA Reception.....	44
3.1.6.2 DGNA Auto Select Group.....	44
3.1.6.3 DGNA Auto Reselect Group.....	44
3.1.7 Broadcast Call.....	44
3.2 Local Site Trunking.....	45
3.2.1 Entering Local Site Trunking.....	45
3.2.2 Exiting Local Site Trunking.....	45
3.3 Direct Mode Operation.....	46
3.3.1 Entering DMO Mode.....	46
3.3.2 Making Group Calls in DMO.....	46
3.3.3 Receiving Group Calls in Idle.....	47
3.3.4 D-PTT Preempt Group Call.....	47
3.3.4.1 Preempting Group Calls.....	47
3.3.5 Selecting DMO Communications Options.....	47
3.3.6 DMO Private Priority Call.....	48
3.3.7 Talkgroup for Individual Calls.....	48
3.3.8 Communication through Repeaters.....	48
3.3.9 Communication Through Gateways.....	49
3.3.10 Gateway and Repeater Synchronization.....	50
3.4 Transmit Inhibit Mode.....	50

3.5 Emergency Operations.....	51
3.5.1 Emergency Alarm.....	51
3.5.2 Emergency Group Call.....	51
3.5.2.1 Making Emergency Group Calls.....	52
3.5.2.2 Receiving Emergency Group Calls.....	52
3.5.3 Non-Tactical Emergency.....	52
3.5.4 Emergency Individual Calls (Private or MSISDN).....	53
3.5.5 Emergency SDS Status.....	53
3.5.6 Emergency Hot Microphone.....	53
3.5.7 Alternating Hot Microphone.....	53
3.5.8 Invisible Emergency.....	54
3.5.9 Emergency Mode by Dialing.....	54
3.5.10 Emergency Destination in Local Site Trunking.....	54
3.5.11 Exiting Emergency Operations.....	54
<b>Chapter 4: Main Menu.....</b>	<b>55</b>
4.1 Scrolling through the Menu.....	55
4.2 Menu Icons.....	55
4.3 Dialer.....	56
4.3.1 Making Private Calls.....	56
4.3.2 Making Phone or PABX Calls.....	57
4.4 Messages.....	57
4.4.1 New Message.....	58
4.4.1.1 Sending Messages to Private or Phone.....	58
4.4.1.2 Sending Messages to Groups.....	58
4.4.1.3 Sending Store and Forward Messages.....	58
4.4.1.4 Delivery Report.....	59
4.4.2 Inbox.....	61
4.4.2.1 Receiving New Messages.....	61
4.4.2.2 Opening the Inbox.....	61
4.4.2.3 Using Submenus in Inbox and Outbox.....	61
4.4.2.4 Embedded Number.....	63
4.4.2.5 Calling Numbers from Messages.....	63
4.4.2.6 Making Group Calls on the Talkgroup of the Message Sender.....	63
4.4.3 Outbox.....	63
4.4.3.1 Opening the Outbox.....	64
4.4.4 Call-Out (CO) Box.....	64
4.4.4.1 Call-Out Icons.....	65
4.4.4.2 Responding to Call-Out Messages.....	65
4.4.5 Templates.....	65

4.4.5.1	Sending User-Defined Templates.....	66
4.4.5.2	Managing User-Defined Templates.....	66
4.4.6	Predefined Templates.....	66
4.4.6.1	Viewing Predefined Templates.....	66
4.4.6.2	Sending Predefined Templates.....	66
4.4.7	Status Messages.....	67
4.4.7.1	Viewing a Status Message Number.....	67
4.4.7.2	Sending Status Messages.....	67
4.4.7.3	Targeted Status Messages.....	68
4.4.8	Additional Address.....	68
4.4.8.1	Enabling or Disabling Additional Address.....	68
4.4.8.2	Selecting Additional Address.....	69
4.4.9	Call-Out Availability.....	69
4.4.9.1	Setting Call-Out Availability.....	69
4.5	Favorite Contacts.....	69
4.5.1	Dialing through the Favorite Contacts List.....	69
4.6	Contacts.....	70
4.6.1	Dialing through the Contact List.....	70
4.7	Talkgroup.....	71
4.7.1	Selecting Favorite Talkgroup.....	71
4.7.2	Editing Talkgroups in Favorite Folder.....	71
4.7.3	Setting Talkgroup Folders.....	72
4.7.4	Changing the Talkgroup Folders using RCU.....	72
4.7.5	Selecting Extended Folders Talkgroup.....	72
4.7.6	Editing Extended Folders Talkgroup.....	72
4.8	Bluetooth.....	73
4.8.1	Bluetooth Settings.....	73
4.8.1.1	Configuring Bluetooth Settings.....	73
4.8.2	Enabling and Disabling Bluetooth.....	74
4.8.3	Pairing Bluetooth Devices with Your Radio.....	74
4.8.4	Devices.....	75
4.8.4.1	Connecting or Disconnecting Devices.....	75
4.8.4.2	Managing Devices.....	75
4.8.5	Disconnecting All Devices.....	76
4.8.6	Setting Indoor Location.....	76
4.8.6.1	Viewing Detected Beacons.....	76
4.8.7	Connecting Firearms Devices.....	77
4.9	Man Down (Fall Alert).....	77
4.9.1	Setting Man Down (Fall Alert).....	78

4.10 Scan.....	78
4.10.1 Enabling Talkgroup Scanning.....	78
4.10.2 Activating Talkgroup Scanning.....	78
4.10.3 Viewing Scan Lists.....	79
4.10.4 Renaming Scan List.....	79
4.10.5 Clearing Scan List.....	79
4.10.6 Adding Group to Scan List.....	79
4.10.7 Editing Talkgroup.....	80
4.11 Security.....	80
4.11.1 PIN Protect.....	80
4.11.1.1 Protecting the Radio with a PIN Code.....	81
4.11.1.2 Changing PIN Codes.....	81
4.11.2 Setting Keypad Lock.....	81
4.11.3 Air Encryption.....	82
4.11.3.1 Viewing Air Encryption State.....	82
4.11.3.2 Deleting User Keys.....	82
4.11.4 K Validity.....	82
4.11.4.1 Verifying K Validity.....	82
4.11.5 SCK (Air Interface Encryption Class 2).....	83
4.11.5.1 TMO SCK.....	83
4.11.5.2 DMO SCK.....	83
4.11.5.3 Viewing the Status of DMO SCK.....	84
4.12 Setup.....	84
4.12.1 Vibrate.....	84
4.12.1.1 Setting Default Vibrate.....	84
4.12.2 Location.....	85
4.12.2.1 Enabling or Disabling Location.....	85
4.12.3 Language.....	85
4.12.3.1 Setting Language.....	85
4.12.4 Tones.....	85
4.12.4.1 All Tones.....	85
4.12.4.2 D-PTT Tones.....	86
4.12.5 Time and Date.....	86
4.12.5.1 Setting the Time Manually.....	86
4.12.5.2 Setting the Date Manually.....	87
4.12.5.3 Setting Time Offset.....	87
4.12.5.4 Setting Automatic Updates for the Time and Date .....	87
4.12.6 Accessory (Accry) Setup.....	87
4.12.7 Default Setting.....	88

4.12.7.1 Selecting Default Setting.....	88
4.13 My Info.....	88
4.13.1 Viewing Personal Information.....	88
4.13.2 Viewing Talkgroup Subaddresses.....	88
4.14 Recent Calls.....	89
4.14.1 Viewing Recent Calls.....	89
4.14.2 Calling from Recent Calls.....	89
4.14.3 Deleting Recent Calls.....	90
4.15 Networks.....	90
4.15.1 Selecting Network Operation Mode.....	90
4.16 Crypto Menu.....	90
4.16.1 Enabling or Disabling SIM Card End-to-End Encryption.....	91
4.16.2 Enabling or Disabling CRYPTR Micro or Micro HSM End-to-End Encryption.....	91
4.16.3 Setting Clear Call Alarm.....	92
4.16.4 Updating Encryption Keys.....	92
4.16.5 Viewing OPTA.....	92
4.16.6 Starting Crypto Registration.....	92
4.16.7 Configuring Audio Settings.....	93
4.16.8 Setting DMO Encryption Mode.....	93

**Chapter 5: Features..... 94**

5.1 Ambience Listening (AL) Call.....	94
5.2 Bluetooth.....	94
5.2.1 Bluetooth Interactions.....	95
5.2.2 Discoverable Mode.....	95
5.2.3 Add Bluetooth Devices.....	95
5.2.4 Bluetooth Smart Proximity Pairing.....	96
5.2.5 Bluetooth Sensor Data.....	96
5.3 Call-Out.....	96
5.3.1 Types of Call-Out Alerts.....	97
5.3.2 Call-Out Modes Interaction.....	98
5.3.3 Call-Out Service Phases.....	98
5.4 Collaborative Messaging.....	99
5.5 CRYPTR Micro or Micro HSM End-to-End Encryption.....	99
5.6 GNSS Location Service.....	99
5.6.1 Enhance Performance.....	100
5.6.2 Location Report Backlog.....	101
5.6.3 GNSS Accuracy.....	101
5.7 Individual Call.....	102
5.7.1 Private Call.....	102

5.7.2 Phone and PABX Calls.....	102
5.7.3 Receiving Individual Calls.....	103
5.8 SIM Card End-to-End Encryption.....	103
5.9 Terminal Permanent Disable.....	104
5.10 Temporary Disable or Enable.....	104
<b>Appendix A: LED Indications.....</b>	<b>105</b>
<b>Appendix B: Troubleshooting.....</b>	<b>107</b>
<b>Appendix C: Maintenance.....</b>	<b>110</b>
C.1 Extending Battery Life.....	110
C.2 Battery Charging Temperature.....	110
C.3 Additional Battery Warnings/Cautions.....	110
C.4 Looking after Your Radio.....	110
C.4.1 Preventive Maintenance.....	111



# List of Figures

Figure 1: Opening the SIM/microSD Door.....	18
Figure 2: Opening the SIM Connector Door.....	18
Figure 3: Inserting SIM Card.....	18
Figure 4: Closing the SIM Connector Door.....	19
Figure 5: Closing the SIM/microSD Door.....	19
Figure 6: Opening the SIM/microSD Door.....	20
Figure 7: Opening the SIM Connector Door.....	20
Figure 8: Removing the SIM Card.....	20
Figure 9: Closing the SIM Connector Door.....	21
Figure 10: Closing the SIM/microSD Door.....	21
Figure 11: Charger Mode Screen.....	25
Figure 12: ST7500 Controls and Indicators.....	26
Figure 13: Default Home Screen with Icons.....	31
Figure 14: RCU Tone Button.....	39
Figure 15: Trunked Mode Operation.....	42
Figure 16: Direct Mode Operation.....	46
Figure 17: Communication through Repeaters.....	49
Figure 18: Communication Through Gateways.....	49
Figure 19: Areas to Keep Dry.....	111

# List of Tables

Table 1: Special Notations.....	14
Table 2: Battery Icons.....	25
Table 3: ST7500 Controls and Indicators.....	27
Table 4: Text Entry Screen Icons.....	29
Table 5: Keys Usage.....	29
Table 6: PIN Code Authentication Icons.....	30
Table 7: Display.....	31
Table 8: Trunked Mode Operation (TMO) Icons.....	32
Table 9: Direct Mode Operation (DMO) Icons.....	32
Table 10: General Icons.....	33
Table 11: During the Call.....	36
Table 12: One-Touch Button Features.....	40
Table 13: Menu Icons.....	55
Table 14: Description of Delivery Report Notification.....	59
Table 15: Inbox Icons.....	61
Table 16: Outbox Icons.....	63
Table 17: Call-Out Icons.....	65
Table 18: Contact Types.....	70
Table 19: Radio Interactions.....	99
Table 20: Interactions between Radios with and without SIM Cards.....	103
Table 21: LED Status Indications.....	105
Table 22: Battery Charging LED Indications.....	105
Table 23: Displayed Messages.....	107
Table 24: Areas to Keep Dry.....	111

# Safety Information

## RF Energy Exposure and Product Safety Guide for Portable Two-Way Radios

### ATTENTION!

**This radio is restricted to Occupational use only.** Before using the radio, read the RF Energy Exposure and Product Safety Guide for Portable Two-Way Radios that contains important operating instructions for safe usage and RF energy awareness and control for Compliance with applicable standards and Regulations.

For a list of Motorola Solutions-approved antennas, batteries, and other accessories, visit the following website:

<http://www.motorolasolutions.com>

*Under Industry Canada regulations, this radio transmitter may only operate using an antenna of a type and maximum (or lesser) gain approved for the transmitter by Industry Canada. To reduce potential radio interference to other users, the antenna type and its gain should be so chosen that the equivalent isotropically radiated power (e.i.r.p.) is not more than that necessary for successful communication.*

*This radio transmitter has been approved by Industry Canada to operate with Motorola Solutions-approved antenna with the maximum permissible gain and required antenna impedance for each antenna type indicated. Antenna types not included in this list, having a gain greater than the maximum gain indicated for that type, are strictly prohibited for use with this device.*

# Applying for Canadian License

The operation of your Motorola Solutions radio is subject to the Radio communications Act and must comply with rules and regulations of the Federal Government's department of Industry Canada. Industry Canada requires that all operators using Private Land Mobile frequencies obtain a radio license before operating their equipment.

**Prerequisites:** Obtain the latest Canadian License Application form at [http://www.ic.gc.ca/ic\\_wp-pa.htm](http://www.ic.gc.ca/ic_wp-pa.htm).

**Procedure:**

1. Fill in the items as per the instructions. Be sure to print legibly.  
If you need additional space for any item, use the reverse side of the application.
2. Make a copy of your files.
3. Prepare a cheque or money order payable to the "Receiver General for Canada", for an amount for each radio purchased.  
The license is renewed on April 1st each year, and issued for a period of 12 months.
4. Mail your completed application along with your cheque or money order to the closest Industry Canada District office.

# Intellectual Property and Regulatory Notices

## Copyrights

The Motorola Solutions products described in this document may include copyrighted Motorola Solutions computer programs. Laws in the United States and other countries preserve for Motorola Solutions certain exclusive rights for copyrighted computer programs. Accordingly, any copyrighted Motorola Solutions computer programs contained in the Motorola Solutions products described in this document may not be copied or reproduced in any manner without the express written permission of Motorola Solutions.

No part of this document may be reproduced, transmitted, stored in a retrieval system, or translated into any language or computer language, in any form or by any means, without the prior written permission of Motorola Solutions, Inc.

## Trademarks

MOTOROLA, MOTO, MOTOROLA SOLUTIONS, and the Stylized M Logo are trademarks or registered trademarks of Motorola Trademark Holdings, LLC and are used under license. All other trademarks are the property of their respective owners.

## License Rights

The purchase of Motorola Solutions products shall not be deemed to grant either directly or by implication, estoppel or otherwise, any license under the copyrights, patents or patent applications of Motorola Solutions, except for the normal non-exclusive, royalty-free license to use that arises by operation of law in the sale of a product.

## Open Source Content

This product may contain Open Source software used under license. Refer to the product installation media for full Open Source Legal Notices and Attribution content.

## European Union (EU) and United Kingdom (UK) Waste of Electrical and Electronic Equipment (WEEE) Directive



The European Union's WEEE directive and the UK's WEEE regulation require that products sold into EU countries and the UK must have the crossed-out wheeled bin label on the product (or the package in some cases). As defined by the WEEE directive, this crossed-out wheeled bin label means that customers and end-users in EU and UK countries should not dispose of electronic and electrical equipment or accessories in household waste.

Customers or end-users in EU and UK countries should contact their local equipment supplier representative or service centre for information about the waste collection system in their country.

## Disclaimer

Please note that certain features, facilities, and capabilities described in this document may not be applicable to or licensed for use on a specific system, or may be dependent upon the characteristics of a specific mobile subscriber unit or configuration of certain parameters. Please refer to your Motorola Solutions contact for further information.

© 2023 Motorola Solutions, Inc. All Rights Reserved

## Chapter 1

# General Information

### 1.1

## Icon Conventions

The documentation set is designed to give the reader more visual clues. The following graphic icons are used throughout the documentation set.



**DANGER:** The signal word DANGER with the associated safety icon implies information that, if disregarded, will result in death or serious injury.



**WARNING:** The signal word WARNING with the associated safety icon implies information that, if disregarded, could result in death or serious injury, or serious product damage.



**CAUTION:** The signal word CAUTION with the associated safety icon implies information that, if disregarded, may result in minor or moderate injury, or serious product damage.

**CAUTION:** The signal word CAUTION may be used without the safety icon to state potential damage or injury that is not related to the product.



**IMPORTANT:** IMPORTANT statements contain information that is crucial to the discussion at hand, but is not a CAUTION or WARNING. There is no warning level associated with the IMPORTANT statement.



**NOTE:** NOTICE contains information more important than the surrounding text, such as exceptions or preconditions. They also refer the reader elsewhere for additional information, remind the reader how to complete an action (when it is not part of the current procedure, for instance), or tell the reader where something is on the screen. There is no warning level associated with a notice.

### 1.2

## Using this Guide

The following special notations are used throughout the text to highlight certain information or items:

**Table 1: Special Notations**

Example	Description
<b>PTT</b> button	Bold words indicate a name of a key, button, or soft menu item.
<i>Entering TMO</i> tone	Italic words indicate a name of the tone.
Powering Off	Typewriter words indicate the MMI strings or messages displayed on the radio.
<b>Setup</b> → <b>All Tones</b>	Bold words with the arrow between indicate navigation structure in the menu items.

### 1.3

## Feature and Service Availability

This guide describes all available radio features and services. Your service provider may have customized your radio to optimize its use for your individual needs. Check with your service provider to find out the differences from this guide.

## Chapter 2

# Getting Started

Familiarize yourself with basic information on how to use the radio.

## 2.1

### Before Power On

Read this section before you power on your radio for the first time.

#### 2.1.1

### Replacing Antenna

#### Procedure:

1. Remove the antenna by turning anti-clockwise.
2. Replace the new antenna by insert the screw-in base of the antenna into the antenna terminal on the top of the radio.
3. Turn clockwise until tight.

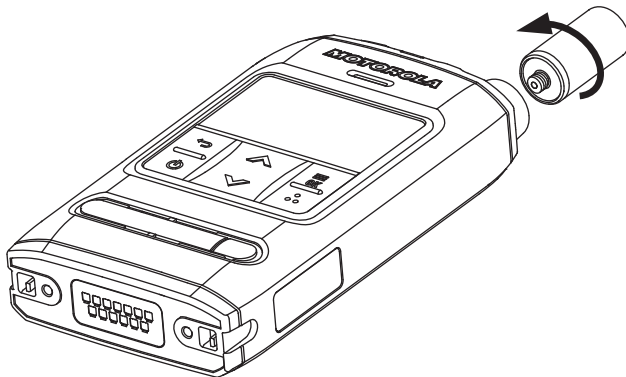

 **IMPORTANT:** Use only the antenna intended for the radio. Use of other antennas can result in significant range loss due to poor RF performance. You can identify the antenna frequency range from the ring at the screw-in base of the antenna.

#### 2.1.2

### Removing and Attaching the Battery Cover



#### NOTE:

To ensure optimum ingress protection of IP65 and IP67, you are recommended to change the battery cover after two years of usage.

#### Procedure:

*To remove the battery cover:*

1. Slide the **Battery Cover Latch** to the right to unlock the battery cover.

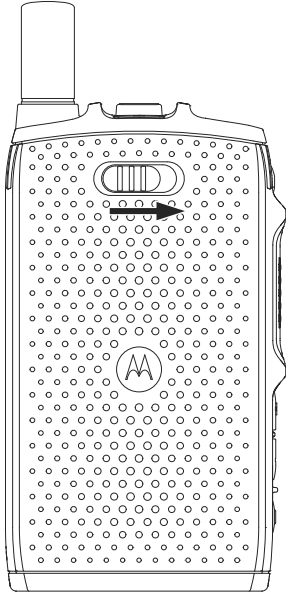

2. Lift the battery cover using the Battery Cover Finger Scoop.

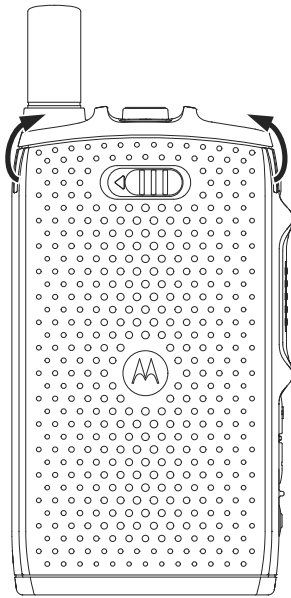

3. Remove the battery cover completely from the radio.

*To attach the battery cover:*

 **NOTE:** Ensure that the **Battery Cover Latch** is at the Unlock position before attaching the battery cover.

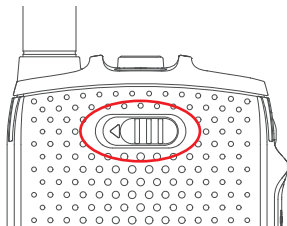

4. Insert the bottom tabs of the battery cover into the slot.



5. Press the top part of the battery cover down followed by the middle part of the battery cover.

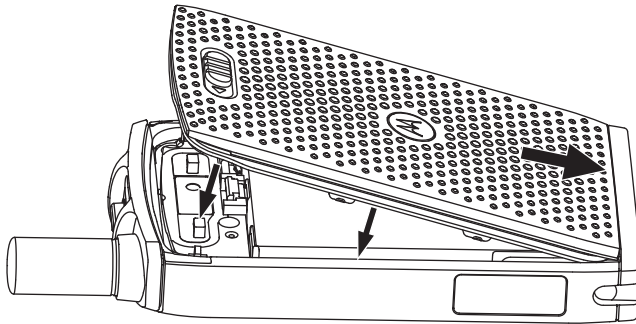

6. Lock the battery cover by sliding the **Battery Cover Latch** to the left.



### 2.1.3

## Installing the SIM Card

### Prerequisites:

Ensure that your radio is either MicroSD card-enabled or SIM card-enabled. The SIM card feature is only available for SIM card-enabled radios.

### Procedure:

1. Remove the battery cover and battery.
2. Flip open the SIM/microSD door of the radio.

**Figure 1: Opening the SIM/microSD Door**

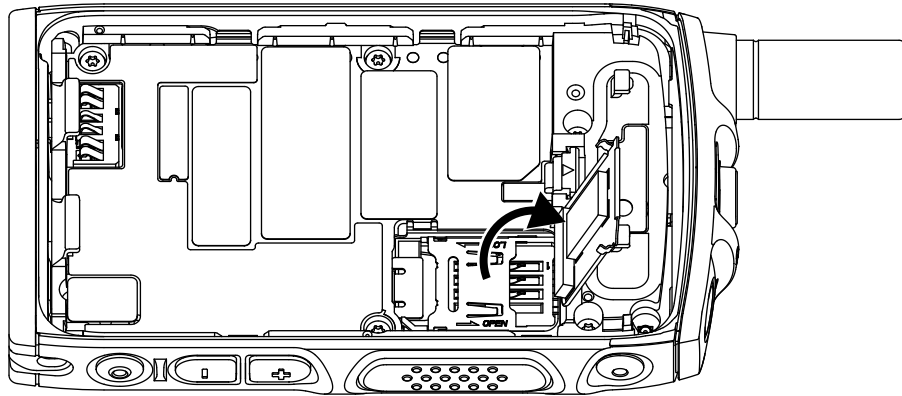

3. Slide up and unlock the SIM connector door (as indicated by the arrow engraved on the SIM connector door).
4. Flip open the SIM connector door.

**Figure 2: Opening the SIM Connector Door**

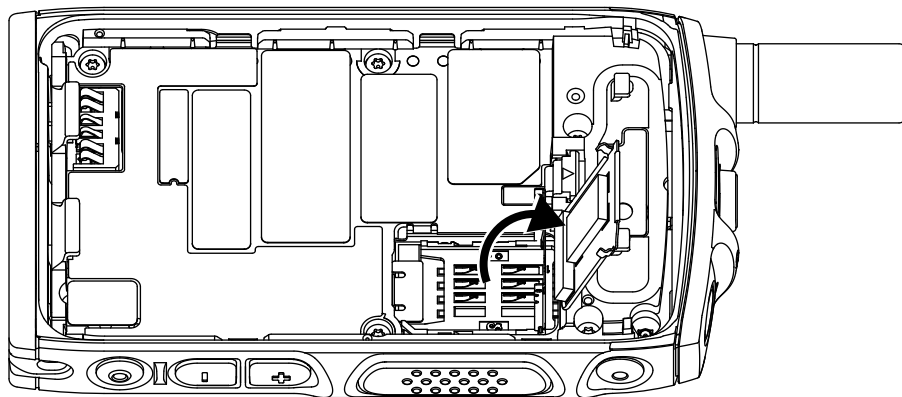

5. Insert the SIM card into the SIM connector slot, ensuring that the gold contact area is facing down.

**Figure 3: Inserting SIM Card**

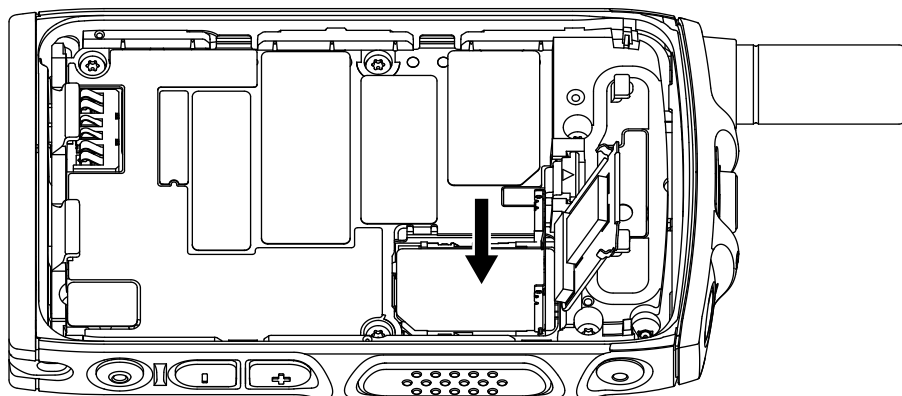

6. Close the SIM connector door and slide it to lock (as indicated by the arrow engraved on the SIM connector door).

**Figure 4: Closing the SIM Connector Door**

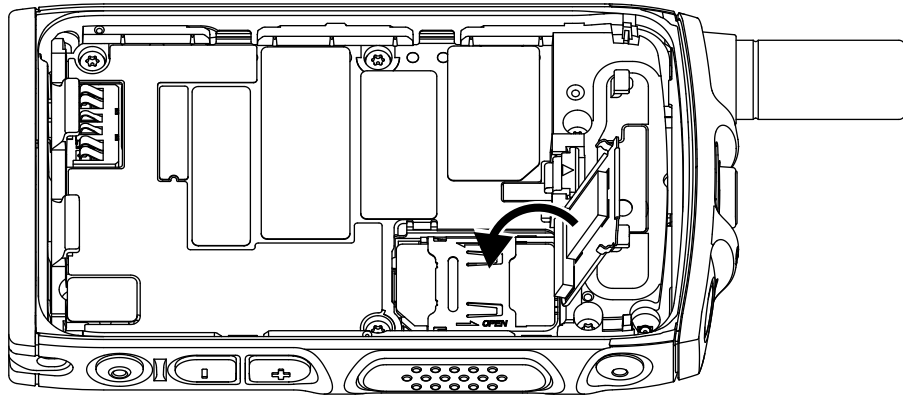

7. Close the SIM/microSD door.

**Figure 5: Closing the SIM/microSD Door**

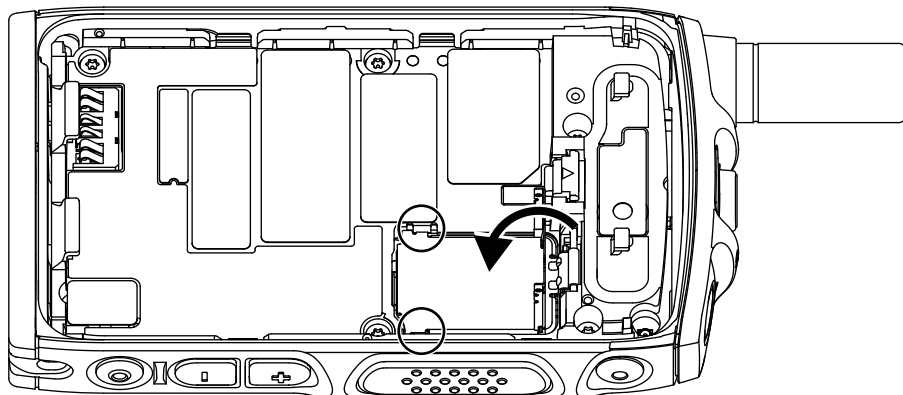

 **IMPORTANT:** Ensure that the latch on the SIM/microSD door is locked in place before placing the battery into the radio.

8. Install the battery and attach the battery cover.

#### 2.1.4

## Removing the SIM Card

### Procedure:

1. Remove the battery cover and battery.
2. Flip open the SIM/microSD door of the radio.

**Figure 6: Opening the SIM/microSD Door**

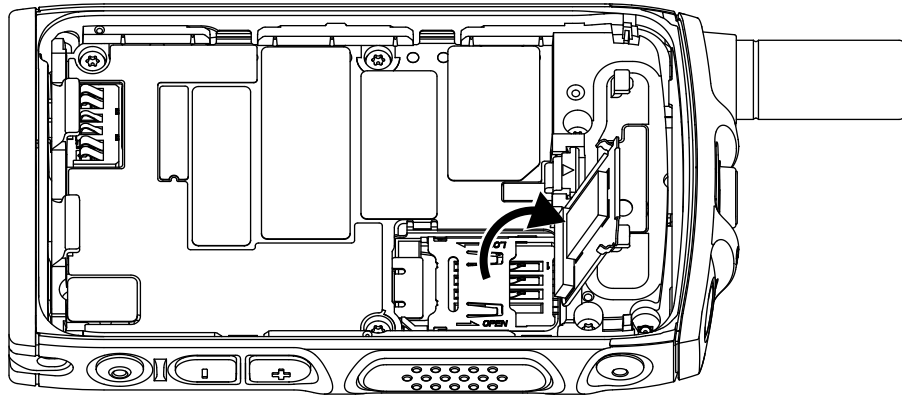

3. Slide up and unlock the SIM connector door (as indicated by the arrow engraved on the SIM connector door).
4. Flip open the SIM connector door.

**Figure 7: Opening the SIM Connector Door**

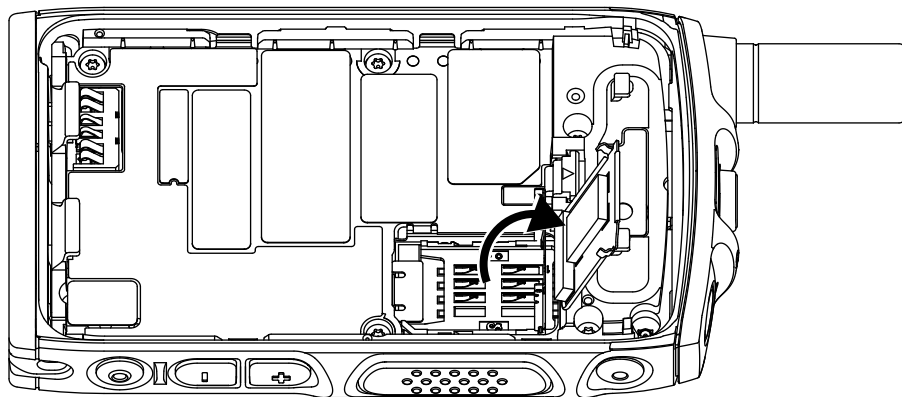

5. Remove the SIM card from the SIM connector slot.

**Figure 8: Removing the SIM Card**

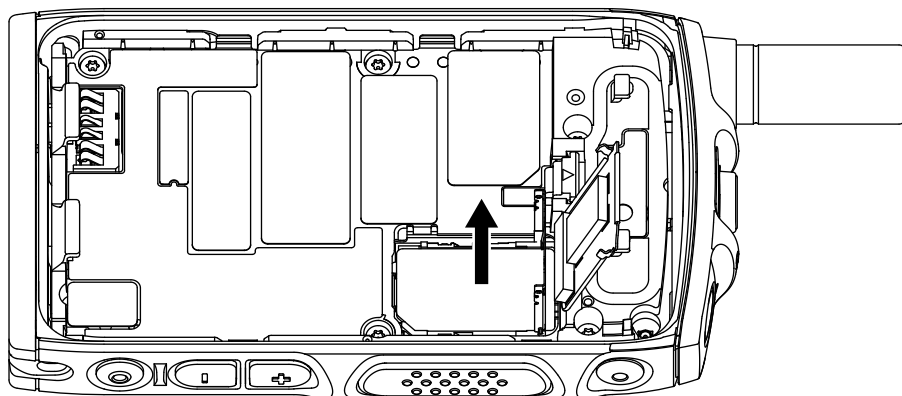

6. Close the SIM connector door and slide it to lock (as indicated by the arrow engraved on the SIM connector door).

**Figure 9: Closing the SIM Connector Door**

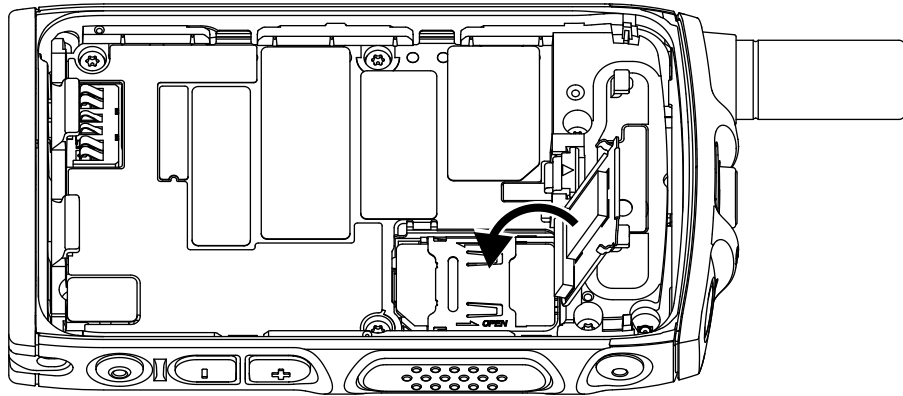

7. Close the SIM/microSD door.

**Figure 10: Closing the SIM/microSD Door**

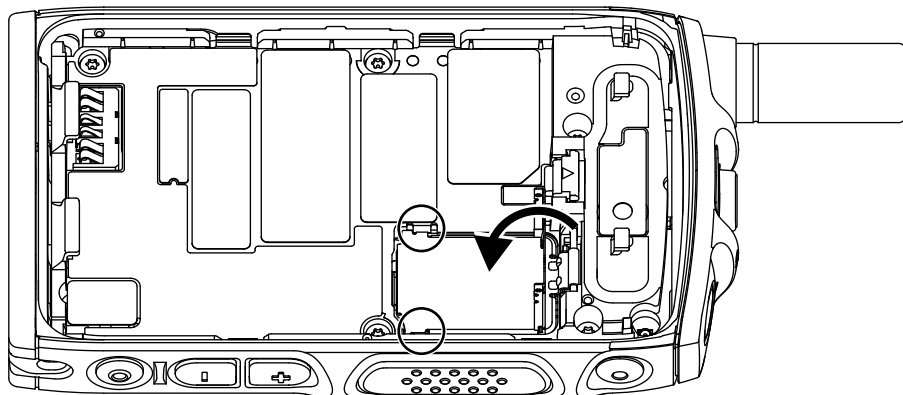

 **IMPORTANT:** Ensure that the latch on the SIM/microSD door is locked in place before placing the battery into the radio.

8. Install the battery and attach the battery cover.

### 2.1.5

## CRYPTR Micro or Micro HSM Card

The CRYPTR Micro or Micro HSM card is supported only by radios equipped with a microSD card slot. The slot is located under the battery at the back of the radio.

### 2.1.5.1

## Installing the CRYPTR Micro or Micro HSM Card

### Procedure:

1. Remove the battery.
2. Flip open the metal cover door of the radio.

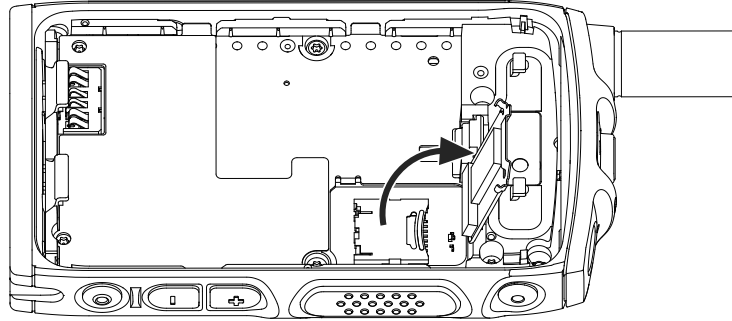

3. Slide to unlock the microSD card holder as indicated by the marking engraved on the microSD card holder.
4. Flip open the microSD card holder.

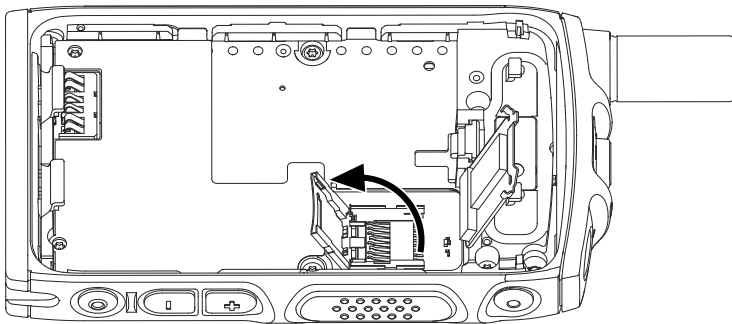

5. Carefully insert the CRYPTR Micro or Micro HSM card into the microSD card holder ensuring that the gold contact area is facing down.

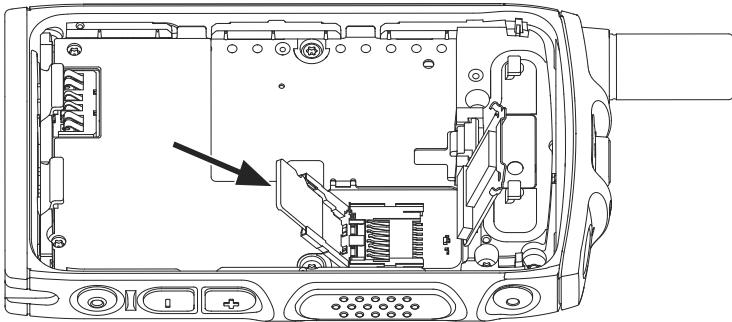

6. Close the microSD card holder and slide it to the lock position.

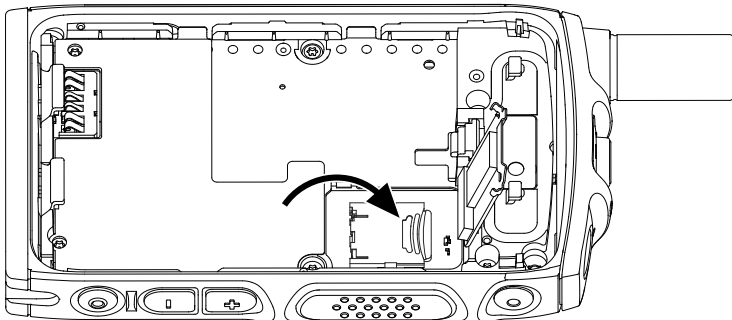

7. Close the metal cover door.

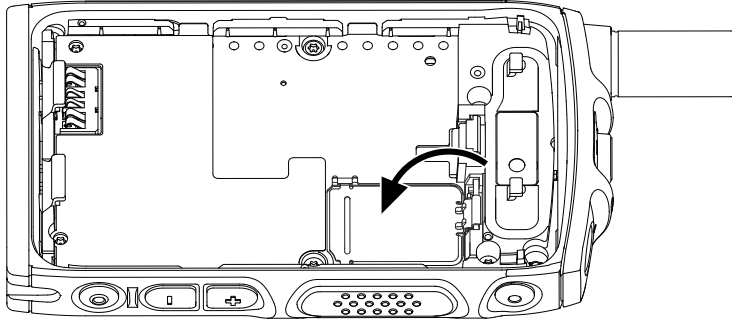

**!** **IMPORTANT:** Please ensure that the latches on the metal cover door is locked in place before placing the battery into the radio.

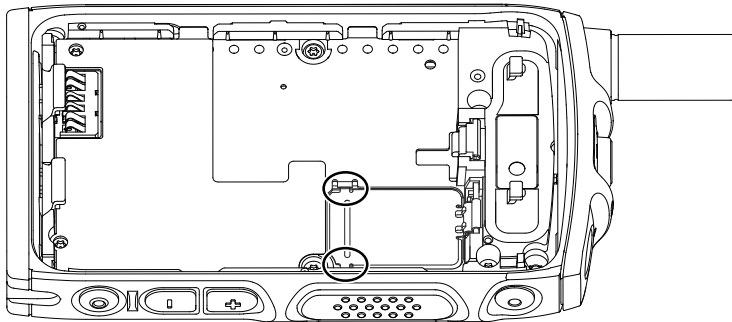

8. Install the battery.

#### 2.1.5.2

### Removing the CRYPTR Micro or Micro HSM Card

#### Procedure:

1. Remove the battery.
2. Flip open the metal cover door of the radio.
3. Slide to unlock the microSD card holder as indicated by the marking engraved on the microSD card holder.
4. Flip open the microSD card holder door.
5. Remove the CRYPTR Micro or Micro HSM card from the microSD card holder
6. Close the microSD card holder and slide it to lock.
7. Close the metal cover door.

**!** **IMPORTANT:** Please ensure that the latches on the metal cover door is locked in place before placing the battery into the radio.

8. Install the battery.

#### 2.1.6

### Installing the Battery

#### Procedure:

1. Insert battery into the compartment as illustrated until the contacts align and the battery hooks in place.

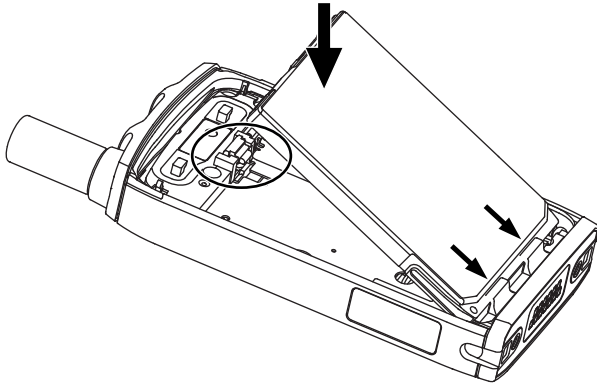

2. Press the battery downward until it clicks.

### 2.1.7

## Removing the Battery

**Prerequisites:** Turn off the radio.

**Procedure:**

1. Pull the clip upwards.

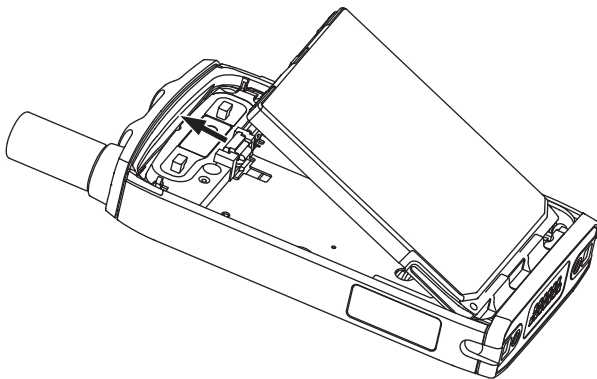

The battery pops up.

2. Lift out the battery.

### 2.1.8

## Charging the Battery



**IMPORTANT:**

Use only Motorola Solutions-approved chargers, which provide optimal performance. Using other chargers may fail to fully charge, or reduce the life of the battery.

Do not charge the battery in a hazardous area.

Do not connect a radio without a battery to the charger.



You can charge a battery separately or attached to your radio.

**Procedure:**

1. Connect the charger to an appropriate power source, according to the specification of the charger.

 **NOTE:** The charger must be connected to a power outlet that is nearby and easily accessed.

2. Perform one of the following actions:

- Desktop chargers – insert the battery or the radio with the battery attached into the appropriate socket of the charger. Ensure that the battery/radio made good connection with the charger. If the battery is inserted, the LED on the charger illuminates indicating that charging is in progress. If the radio with the battery attached is inserted, the Charge Indicator LED on the radio illuminates instead.

 **NOTE:** Vibration is disabled during charging.

If a multi-unit charger LED indicates an error (blinking red light) when the radio is inserted and being charged, reinsert the radio. If the light is still red after several reconnections to MUC, the battery may be damaged or reached its end of life.

**Postrequisites:** The battery may heat up during charging. After charging, make sure that the battery and the radio are within the operating temperature range before using the radio.

2.1.9

## Battery Charging Indications

When the radio is turned off while charging, it displays the Charger Mode screen. The screen displays the charging progress expressed in percentage.















 **NOTE:** The Charger Mode screen does not remain on. The charging condition of a fully depleted battery only has its charging icon displayed after approximately 20–35 minutes. The red LED indicator serves as the primary indicator during the trickle charging state.

To identify the charging status, check the LED Power Indicator. See [LED Indications on page 105](#).

**Figure 11: Charger Mode Screen**



**Table 2: Battery Icons**

Battery Capacity						
						
0%–5%	5%–15%	15%–25%	25%–40%	40%–60%	60%–80%	80%–100%
Battery Charge Progress						
						

### Battery Charge Progress

0%–5%	5%–15%	15%–25%	25%–40%	40%–60%	60%–80%	80%–100%
-------	--------	---------	---------	---------	---------	----------

#### 2.1.10

### Low Battery Indication

The radio indicates low battery level by playing an audible alert when the battery charge falls to a preset level. The default setting is 5 %. The service provider also configures how frequently the alert repeats.

The service provider can also configure the radio to indicate low battery level at 20 %. Every time the battery discharges to the targeted battery level, your radio screen displays `Battery < 20%`. This pop-up message is shown only once. The pop-up message is also shown when the battery level is at 20 % or lower upon radio power-up.

#### 2.2

### ST7500 Controls and Indicators

The simple-to-use controls and indicators of ST7500 allow you to quickly read and respond to alerts received on the radio.

The ST7500 radio specifications are available at <https://www.motorolasolutions.com/st7500>.

**Figure 12: ST7500 Controls and Indicators**

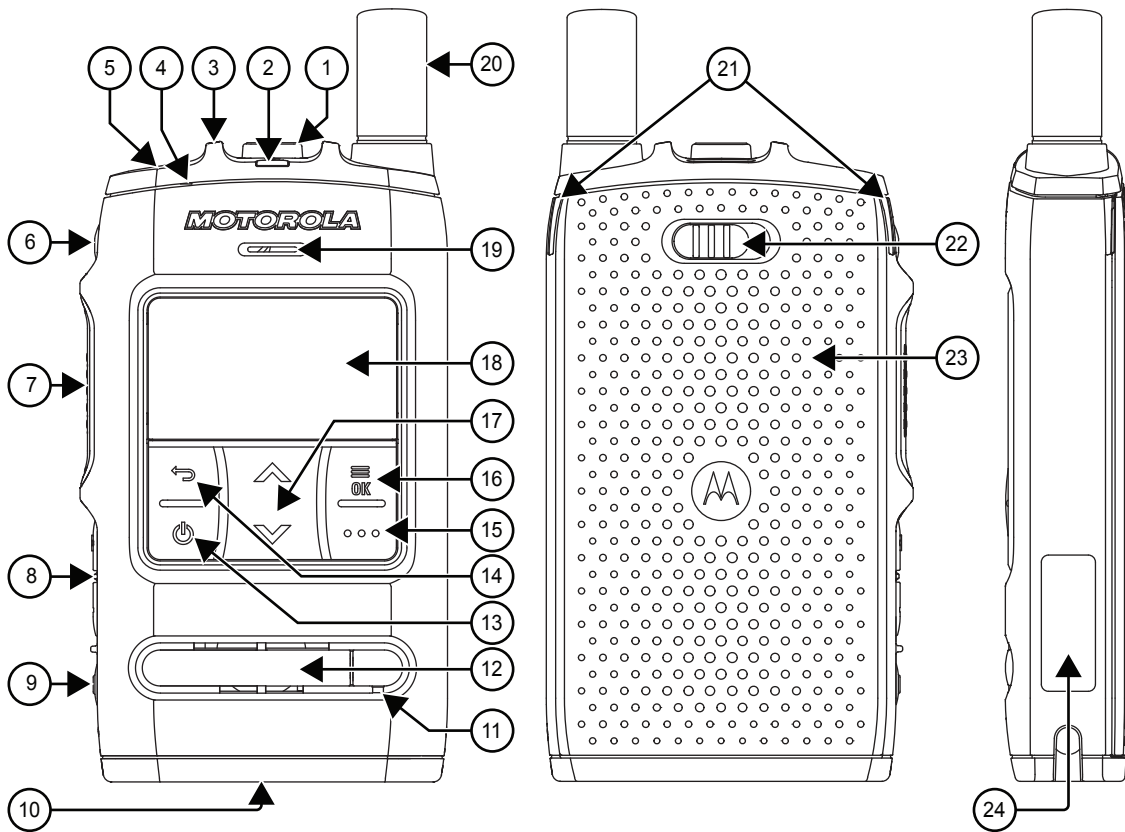

**Table 3: ST7500 Controls and Indicators**

Annotation	Description
1	<p><b>Talkgroup Selector</b>            The <b>Talkgroup Selector</b> has the following functions:</p> <ul style="list-style-type: none"> <li>• Turns on the display when toggled once. Subsequent toggling allows you to scroll through the talkgroups of the current selected folder on the Idle screen.</li> <li>• Scrolls through text in the dialing and messaging editors.</li> </ul>
2	<p><b>LED Coverage Indicator</b>            Shows the coverage status while the radio is transmitting and receiving over the network.</p>
3	<p><b>LED Power Indicator</b></p> <ul style="list-style-type: none"> <li>• Shows the battery status when the radio is charging.</li> <li>• Indicates low battery level when it is blinking red.</li> </ul>
4	<p><b>Top Microphone</b>            The top microphone is activated during high-audio simplex calls.</p>
5	<p><b>Emergency Button</b>            Used to start the Emergency Operations, even when the radio is turned off.</p>
6	<p><b>P1 Programmable Button</b>            Supports the One-Touch Button feature.</p>
7	<p><b>Push-to-Talk (PTT) button</b>            Used to initiate a simplex call.</p> <p> <b>NOTE:</b> Pressing <b>PTT</b> activates the display for three seconds.</p>
8	<p><b>Volume button</b>            Increases or decreases the volume by pressing + or -.</p>
9	<p><b>P2 Programmable Button</b>            Supports the One-Touch Button feature.</p> <p>Changes the input characters to lower or upper case alphabets, numbers, or symbols in the messaging editor.</p>
10	<p><b>Bottom Connector</b>            Used for connecting accessories and programming the radio.</p>
11	<p><b>Bottom Microphone</b>            Activated during low-audio duplex calls.</p>
12	<p><b>Speaker</b>            Provides good quality high audio during simplex calls.</p>
13	<p><b>Power button</b></p> <ul style="list-style-type: none"> <li>• Turns the display on or off.</li> <li>• Turns the radio on or off.</li> </ul>
14	<p><b>Back button</b>            The <b>Back</b> button has the following functions:</p>

Annotation	Description
	<ul style="list-style-type: none"><li>• Returns to the previous menu or deletes the last entered character in the dialing and messaging editors when pressed once.</li><li>• In the dialing and messaging editors, pressing and holding the button clears the entire main text area.</li></ul>
15	<b>P3 Programmable Button</b> Supports the One-Touch Button feature.
16	<b>Menu/OK button</b> The <b>Menu/OK</b> button is used to: <ul style="list-style-type: none"><li>• Select or enter context-sensitive menus.</li><li>• Select the highlighted alphanumeric character in the dialing and messaging editors.</li><li>• Show the dialing menu while in the dialing editor.</li></ul>
17	<b>Navigation buttons</b> The <b>Up</b> or <b>Down</b> button is used to navigate within the menu hierarchy or to edit alphanumeric text in the dialing and messaging editors.
18	<b>PMOLED Display</b> The 1.54-inch screen features a monochrome display with a resolution of 128 x 64 pixels. The screen consists of a two-line display area with the top line showing radio icons and the bottom line showing text.
19	<b>Earpiece</b> The Earpiece is active during low-audio simplex or duplex calls.
20	<b>Hybrid Antenna</b>
21	<b>Battery Cover Finger Scoop</b>
22	<b>Battery Cover Latch</b> Used to lock or unlock the battery cover.
23	<b>Battery Cover</b>
24	<b>Seal Label</b>  <b>IMPORTANT:</b> Do not remove the seal label to avoid compromising the ingress protection of IP67.

### 2.3

## Powering On the Radio

#### Procedure:

Press and hold **On** button until the status LED blink.

**Result:** Your radio performs a self-check and registration routine. After successful registration, your radio is in service.



**NOTE:** Your radio powers on without visible and audible notification if Covert Solution is activated.

2.4

## Writing Text





This section provides information on entering texts on your radio.

2.4.1

### Text Entry Icons

In the text entry screen, icons tell you which text entry mode and method you are using. A character counter displayed on the text entry icon indicates the amount of characters that can be entered.

**Table 4: Text Entry Screen Icons**

Icon	Description
	a–z – No capitals
	Capitalize first letter only
	A–Z – All capitals
	Numbers
	Punctuation and symbols

2.4.2

### Keys Usage

**Table 5: Keys Usage**

Key	Description
<b>Up</b> navigation button	Press to scroll through the letters, numbers, or symbols.
<b>Down</b> navigation button	Press to scroll through the letters, numbers, or symbols.
<b>Back</b> button	<ul style="list-style-type: none"> <li>• Press once to delete the last entered character.</li> <li>• Press and hold to clear the entire main text area.</li> </ul>
<b>Menu/OK</b> button	<ul style="list-style-type: none"> <li>• Press once to select the highlighted alphanumeric character.</li> <li>• Press and hold to show the dialing menu while in the dialing editor.</li> </ul>
<b>Talkgroup Selector</b>	Toggle to scroll through the text in the dialing and messaging editor.

## 2.5

# PIN Code Authentication

If pre-set by your service provider, the radio has active PIN Code Authentication, which helps you increase security and protect your radio against unauthorized use.

The BSI PIN code is read from the TETRA SIM card and cannot be changed or disabled. However, the general PIN code read from the codeplug configuration can be changed and disabled using radio MMI or codeplug.

You are asked to enter the PIN code each time you turn on the radio.



**NOTE:**

If your radio is using BSI PIN authentication, the radio disables the general PIN authentication.

**Table 6: PIN Code Authentication Icons**

Icon	Description
	<b>Radio is Locked</b> Indicates that PIN code authentication is enabled.
	<b>Radio is Blocked</b> Indicates that incorrect PIN code entry exceeded maximum tries.
	<b>Code Entry Field</b> Enter your PIN code to access your radio or the PUK code to unblock your radio.
	<b>Enter Old Code</b> Prompts for old PIN code entry when PIN code change is selected.
	<b>Enter New Code</b> Prompts for new PIN code entry when PIN code change is selected.
	<b>Re-Enter New Code</b> Prompts for a repeat of the new PIN code entry when PIN code change is selected.

### 2.5.1

## Unlocking Your Radio

**Prerequisites:** Radio displays `Unit Locked Enter Code`.

**Procedure:**

Enter the PIN code at the prompt.



**NOTE:**

For radios with general PIN authentication, the PIN length is a fixed 4-digit code. For radios with BSI PIN authentication, the PIN length is configurable by your service provider up to a maximum of 8-digit code.

Your radio enters the default home display.

## 2.5.2

# Unblocking Your Radio

If you have entered the incorrect PIN code for more than three times (by default), use the PIN Unblocking Key (PUK) to unblock your radio.

**Prerequisites:** Radio displays `Unit Blocked Enter PUK`.

### Procedure:

1. Enter the PUK code at the prompt.

 **NOTE:** The PUK is a master code provided by your service provider. For radios with general PUK authentication, the PUK length is a fixed 8-digit code. For radios with BSI PUK authentication, the PUK length is configurable by your service provider up to a maximum of 8-digit code.

When PUK code is successfully entered, radio displays the PIN code prompt.

2. Enter the PIN code at the prompt.

 **NOTE:** If change PIN option is enabled by your service provider, you are able to change your PIN code. Enter your new PIN code twice to change the PIN code.

## 2.6

# Display

This section presents the default home screen elements of the radio.

**Figure 13: Default Home Screen with Icons**

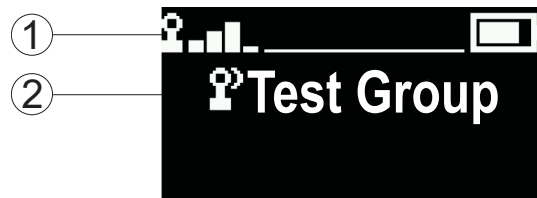

**Table 7: Display**

Annotation	Description
1	Status icon area
2	Text display area

### 2.6.1

# Configurable Idle Screen

Your service provider can configure the information that is displayed on the idle screen below the status icon area. The displayed information depends on the radio configuration and services supported.

- Scan List Alias
- Talkgroup Alias

 **NOTE:**

- If the Favorite Talkgroup is selected, an icon preceding it denotes it as TMO or DMO.
- If the talkgroup alias exceeds the display, press the navigation key to read the remaining text.

- Time and Date





Order and visibility of these items are also subject of the Configurable Idle Screen settings.

## 2.7





# Status Icons

Status icons appear when your radio is engaged in certain activities or when you have activated certain features.

**Table 8: Trunked Mode Operation (TMO) Icons**

Icon	Description
	<b>In Service</b>
	<b>No Service</b>
	<b>Signal Strength</b> The more bars, the stronger the signal.
	<b>Migration</b> Radio is registered to a foreign network.
	<b>Scan</b> Talkgroup scanning is activated in the radio.













**Table 9: Direct Mode Operation (DMO) Icons**















Icon	Description
	<b>Direct Mode Call</b> Radio is receiving a Direct Mode call. The more bars, the stronger the signal.
	<b>Direct Mode</b> Radio is in Direct Mode, radio-to-radio communication.
	<b>DMO Gateway Communication Mode</b> Indicates that the gateway is selected. This icon has the following states: <b>Solid</b> When the radio is synchronized with the gateway. <b>Blinking</b> When the radio is not synchronized or during attachment. <b>No icon</b> During a radio-to-radio and repeater call.
	<b>DMO Repeater Communication Mode</b> Indicates that the <b>Repeater</b> or <b>GW + Rep</b> option in DMO mode is selected. This icon has the following states: <b>Solid</b> When the radio has detected the repeater, for example, when the radio receives a presence signal. <b>Blinking</b> When the radio has not detected the repeater or during attachment.







Icon	Description
	<p><b>No icon</b> During a radio-to-radio and gateway call.</p>

Table 10: General Icons

Icon	Description
	<p><b>Low Audio</b> Audio mode is changed to low.</p>
	<p><b>High Audio</b> Audio mode is changed to high.</p>
	<p><b>Earpiece Connected</b> Earpiece is connected to the radio.</p>
	<p><b>Battery Strength</b> Indicates the charge of the battery.</p>
	<p><b>Battery Charging</b> Indicates that the battery is charging.</p>
	<p><b>Emergency</b> Radio is in Emergency Operation.</p>
	<p><b>Man Down (Fall Alert) Active</b> Indicates that the Man Down (henceforth known as Fall Alert) feature is active.</p>
	<p><b>Man Down (Fall Alert) Alert</b> Indicates that the Man Down (Fall Alert) feature is active. This icon has the following states:  <b>Blinking (Pre-Alert State)</b> Triggered to inform and check on your status to avoid false Man Down (Fall Alert) trigger. To exit the pre-Alert state, change the conditions or press the PTT button.  <b>Solid (Emergency State)</b> Your radio enters Alert mode once pre-alert state timed-out.</p>
	<p><b>Man Down (Fall Alert) Failure</b> Indicates that the Man Down (Fall Alert) device failed.</p>
	<p><b>Bluetooth Connected</b> Bluetooth is enabled and at least one device is connected.</p>
	<p><b>Bluetooth Disconnected</b> This icon has the following states:  <b>Solid</b> Bluetooth is enabled but no device is connected.  <b>Blinking</b> Bluetooth is enabled and the radio is in Discoverable Mode or connection with a remote device is being established.</p>
	<p><b>Indoor Location Enabled</b> Indicates that Indoor Location operation is enabled.</p>

Icon	Description
	<b>Indoor Location Suspended</b> Indicates that Indoor Location operation is temporarily suspended.
	<b>New Message Has Arrived</b> Indicates that a new message has arrived.
	<b>Normal Call-Out Alert</b> Indicates Normal Call-Out alert.
	<b>Normal Call-Out Alert Accepted</b> Indicates that Normal Call-Out alert has been accepted.
	<b>Normal Call-Out Alert on Standby</b> Indicates that Normal Call-Out is on standby.
	<b>Stormplan Call-Out Alert</b> Indicates Stormplan Call-Out alert.
	<b>Stormplan Call-Out Alert Accepted</b> Indicates that Stormplan Call-Out alert has been accepted.
	<b>Test Call-Out Alert</b> Indicates Test Call-Out alert.
	<b>Test Call-Out Alert Accepted</b> Indicates that Test Call-Out alert has been accepted.
	<b>Call-Out Fallback Alert</b> Indicates Call-Out Fallback alert.
	<b>Call-Out Alert Arrived</b> Indicates a receipt of a new Call-Out message.
	<b>Call-Out Alert Unread</b> Indicates unread alert in the <b>CO Box</b> .
	<b>End-to-End Encryption (E2EE)</b> Solid, when E2EE is enabled: <ul style="list-style-type: none"><li>• For the selected talkgroup,</li><li>• For the highlighted private number,</li><li>• For the manually entered private number,</li><li>• When transmitting voice in Group Calls,</li><li>• When transmitting voice in Simplex Private Calls.</li></ul> Blinking, when E2EE is enabled: <ul style="list-style-type: none"><li>• When receiving voice in Group Calls,</li><li>• When receiving voice in Simplex Private Calls,</li><li>• During encrypted Duplex Private Calls.</li></ul>
	<b>Encryption Off</b> Blinking – Indicates that the SIM Card End-to-End Encryption is disabled in DMO and TMO Modes.

Icon	Description
	<b>SIM End-to-End Encryption (E2EE)</b> Solid – Indicates that the SIM Card E2EE is enabled in TMO Mode.
	<b>SIM End-to-End Encryption (E2EE)</b> Solid – Indicates that the SIM Card E2EE is enabled in DMO Mode. Numbers 1 and 2 point to the type of DMO Encryption keys that has been selected.
	<b>Non-Secured Call – Air Encryption Unavailable</b> Blinking – Indicates that Air Encryption is not available when the radio: <ul style="list-style-type: none"> <li>• Is in the Local Site Trunking Mode.</li> <li>• Attempts to connect to a gateway.</li> </ul>
	<b>Non-Secured Call – Air Encryption Unavailable</b> Blinking – Indicates that Air Encryption is not available in DMO Mode. The icon appears after the <b>PTT</b> button is pressed.

## 2.8

# Holding Your Radio

Your radio has two microphones: a top microphone for simplex dispatcher/private calls and a bottom microphone for duplex telephone-like calls.

The radio is also equipped with an internal speaker for high audio (located at the middle of the unit) and an internal earpiece for low audio (located at the top of the unit).

 **NOTE:** For best performance speak directly into the top microphone.

## Simplex Calls

When using high audio, hold your radio a vertical position with its top microphone 5–10 cm away from your mouth. Speak into the top microphone. Listen through the internal speaker. Keep the antenna at least 2.5 cm from your head and body.



## Duplex Calls

When using low audio, hold your radio as you would a telephone. Speak into the bottom microphone. Listen through the earpiece. Keep the antenna at least 2.5 cm from your head and body.



When radio is toggled to high audio during emergency Full Duplex Private Calls (FDPC) mode, hold you radio a vertical position with its top microphone 5–10 cm away from your mouth. Speak into the top microphone. Listen through the internal speaker. Keep the antenna at least 2.5 cm from your head and body.

## Lapel/Shoulder Use

For Group and Private Calls turn your head towards your shoulder/lapel, and speak directly into the top microphone. Listen through the internal speaker.

### 2.9

## High or Low Audio Toggle

Your radio is able to switch from the external earpiece to the main speaker using One-Touch button and is not required to disconnect the external earpiece or PHF.

The states of the routed audio are:

- **Speaker HIGH** – indicates that audio is routed to the main speaker.
- **Speaker LOW** – indicates that audio is routed to the earpiece or PHF earpiece, and not to the main speaker.

### 2.9.1

## Using High Audio

**When and where to use:** Placing or receiving a Phone, PABX, or Duplex Private call.

### Procedure:

1. Hold your radio in a vertical position with its top microphone 5 cm to 10 cm away from your mouth.
2. Speak into the top microphone and listen through the internal speaker.  
Keep the antenna at least 2.5 cm from your head and body.

### 2.9.2

## Using Low Audio

**When and where to use:** Placing or receiving a Phone, PABX, or Duplex Private call.



**NOTE:** It can also be used in group mode when discrete listening is required.

### Procedure:

1. Hold your radio as you would a telephone.
2. Speak into the bottom microphone and listen through the earpiece.  
Keep the antenna at least 2.5 cm from your head and body.

### 2.10

## During a Call

During the call, if the audio is routed to different setting, the following is displayed:

**Table 11: During the Call**

Audio Setting	Displayed Notification
Audio goes to the main speaker	Speaker HIGH

Audio Setting	Displayed Notification
Audio goes to the earpiece	Speaker LOW

 **NOTE:** You can change the High or Low audio setting using the OTB. See [One-Touch Buttons on page 40](#).

## 2.11

# Selecting Talkgroups

Follow these procedures to select talkgroup manually. If the selected talkgroups is an InterSystem Interface (ISI) talkgroup, your radio can migrate to another talkgroup linked network, changing the talkgroup automatically.

**Prerequisites:** Talkgroups are pre-set by your service provider.

### Procedure:

*From the home screen, use one of the following methods:*

- Toggle the **Talkgroup Selector** button until the required talkgroup name is displayed.

 **NOTE:** The **Talkgroup Selector** only list out the talkgroups of the current folder. To view talkgroups from other folders, see [Setting Talkgroup Folders on page 72](#) to change folders.

- Select **Menu/OK** → **Favorite TGs** → **Select TGs**. Select the required talkgroup and press **Menu/OK** to confirm.

## 2.12

# Entering TMO or DMO Mode

**Prerequisites:** Your service provider can enable this mode.

### Procedure:

1. From the home screen, press the **Menu/OK** key.
2. Select **Networks**.
3. Select **Trunked Mode/Direct Mode**.

 **NOTE:** Changing talkgroups using the **Talkgroup Selector** button also changes the network mode accordingly for the selected talkgroup when in favorite folders.

## 2.13

# Covert Solution

 **NOTE:** This is a Software Selling Feature.

Covert Solution enables you to completely shut down all visible and audible alerts and notifications, making the radio unnoticeable even in a silent and dark environment.

The Covert Solution is only available through One-touch button.

All audio activities are suppressed to the built-in speaker and microphone, and the audio is routed to and from the accessory only. If there is no accessory connected, the audio is routed to the small earpiece on the radio.

When the Covert Solution is turned on:

- The screen is disabled.
- All buttons are disabled except for the following buttons:
  - PTT
  - Emergency
  - Covert Solution One-touch button (to exit Covert Solution)
- The LED indicator is disabled.
- Change folder and talkgroup through MMI, over the air, and RCU.

When the Covert Solution is turned off, the following settings remain:

- Volume
- TXI
- Emergency

When paired with a Remote Control Unit (RCU), you are able to communicate using Mission Critical Communication Tones. The RCU is a third-party device that sends out tones as beeps in a group call. Pressing the button for tones on the RCU starts the group call and each press of the button produces beeps which are heard by all recipients and the initiator. To transmit a voice call in Covert Solution on the RCU, press the **PTT** button on the RCU. If an earpiece accessory is not connected to the radio, the voice call is routed to the low audio speaker of the radio.

### 2.13.1

## Sending Mission Critical Communication Tones

### Procedure:

Press the **RCU Tone** button.

Morse code tone pulses is heard from your audio accessory, and transmitted to the receiver.



**NOTE:** You cannot send Morse code during an active voice transmission.

Figure 14: RCU Tone Button

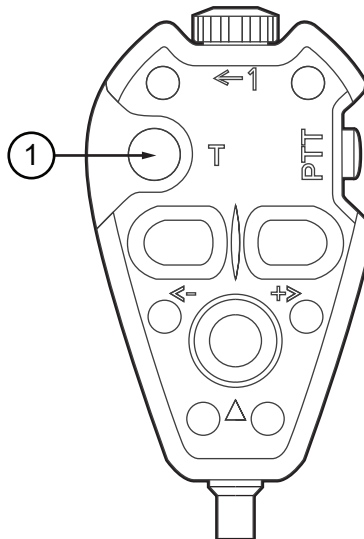

No.	Description
1	RCU Tone Button

 **NOTE:** The RCU is a small third-party device attached to your covert radio over a wire.

## 2.14

# Over The Air Programming

 **NOTE:** This is a Software Selling Feature.

Over The Air Programming (OTAP) enables remote radio reconfiguration over TETRA network.

**Prerequisites:** Your radio display shows an **OTAP** prompt with `Reboot required. Accept new configuration?` text for a new configuration update.

### Procedure:

Select **Yes** to accept or **No** to reject the new configuration update.

 **NOTE:** A timer is set when the prompt is displayed. Request is automatically rejected if there is no user response to the prompt when the timer runs out.

**Result:** When the OTAP installation prompt is accepted, your radio updates with the new configuration as received over OTAP. Visible indication guidance and update status is provided during the update. When the OTAP installation prompt is rejected, your radio returns to idle mode.

2.15

## One-Touch Buttons

The One-Touch Button (OTB) feature allows you to activate a feature by a long key press of the programmable button.

**Table 12: One-Touch Button Features**

Feature	Description
Activation of Covert Solution	Turns Covert Solution on or off.
Bluetooth Smart Proximity Pairing	Activates scanning for Bluetooth Smart Proximity Pairing.
Change Talkgroup	Changes the talkgroup to the one programmed by your service provider.
Change Talkgroup to the Previously Selected Talkgroup	Changes the talkgroup of the radio to the previously selected talkgroup (DMO or TMO).
Default Setting	Resets the radio to its default settings.
Direct Private Number Dialing	Displays the private dialing editor.
Disconnect All Connected Bluetooth Devices	Disconnects all Bluetooth devices connected to the radio.
Display Heart Rate	Displays the heart rate value received from the connected GATT-based heart rate sensor.
Display Time	Displays universal time on the home screen.
Enable/Disable Howling Suppression	Enables or disables Howling Suppression.
Hi/Low Audio	Toggles audio between the external earpiece and the main speaker.
Initiate Call-Out Fallback	Sends a Call-Out Fallback Alert.
Predefined Template	Direct access to predefined templates for messages.
Private Call	Initiates a simplex or duplex private call to a predefined entry in the contact list or to the last group call originator.
Send Status Message	Sends a dedicated status message to a dedicated address.
Sending Targeted Status	Sends a status message to a specific address.
Shortcuts	Enables One-Touch Button for quick access to the menu screen (for example, Predefined).
Timed Talkgroup Change	<p>Makes a predefined talkgroup the selected talkgroup for a specified amount of time. While you are using the predefined talkgroup, the second press of the One-Touch Button results in:</p> <ul style="list-style-type: none"> <li>the radio returning to the original talkgroup.</li> <li>the radio restarting the timer before returning to the previously selected talkgroup.</li> <li>no action on the radio, depending on the configuration.</li> </ul> <p>After the timer expires, the radio returns to the previously selected talkgroup.</p>



Feature	Description
TMO ↔ DMO Switch	Toggles between TMO and DMO modes.
TMO Talkgroup Scan	Turns the Talkgroup Scan feature in TMO Mode on or off.
Toggle Bluetooth Discoverable Mode	Turns Discoverable Mode on or off.
Toggle Hi or Low Audio	Toggles audio between the external earpiece and the main speaker.  <b>NOTE:</b> This feature is supported in emergency Full Duplex Private Calls (FDPC) mode. Press the One-Touch Button to toggle high or low audio state during incoming or outgoing emergency FDPC.
Toggle Man Down (Fall Alert) On or Off	Turns the Man Down (henceforth known as Fall Alert) feature on or off.
Toggle Speaker During Call	Enables or disables the loudspeaker during a call.
Turn On/Off Bluetooth	Turns Bluetooth on or off.
Unassigned	The radio displays <code>Unassigned Button</code> when no feature is assigned to this button.

## Chapter 3

# Modes

This chapter contains information on available modes that the radio can operate in.

### 3.1

## Trunked Mode Operation

Trunked Mode Operation (TMO) requires the switching and management infrastructure.

TMO enables various voice and data communication types such as group calls. TMO also enables access to features related to infrastructure such as packet data.

**Figure 15: Trunked Mode Operation**

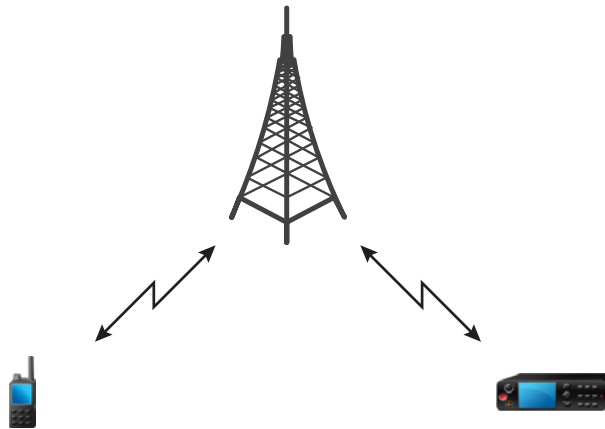

#### 3.1.1

### Entering TMO Mode

**Procedure:**

1. From the home screen, press the **Menu/OK** key.
2. Select **Networks**.
3. Select **Trunked Mode**.

#### 3.1.2

### Making Group Calls in TMO

The Group Call is received by all members of the selected group who have their units turned on and are connected through the network.

**Procedure:**

1. Press and hold the **PTT** button.

2. Wait for the *Talk Permit* tone (if configured) and then speak into the microphone. Release the **PTT** button to listen.

### 3.1.3

## Receiving Group Calls in Idle

### Procedure:

1. Your radio receives a Group Call.

 **NOTE:** The incoming Group Call is signaled by a *Receiving Group Call* tone.

2. To respond, press and hold the **PTT** button.

### 3.1.4

## Receiving Group Calls during Ongoing Group Calls

While in active Group Call, your radio receives a Group Call with a higher priority. Your radio is forced to end the current Group Call and automatically join the incoming one.

### 3.1.5

## D-PTT Preempt Group Call

 **NOTE:** This is a Software Selling Feature.

The D-PTT Preempt Group Call allows superiors to take over and speak in an ongoing group call by making preemptive priority calls.

 **NOTE:** Your radio can only support either the D-PTT Tone feature or D-PTT Preempt Group Call feature at a time.

By pressing the PTT (Push-To-Talk) button twice, you make a preemptive request to temporarily interrupt an ongoing group call and gain permission to speak.

If your group call is preempted and you are still pressing the **PTT** button, your radio displays the **PTT Denied** prompt.

If your service provider enables the visual notification, your radio displays the **PTT Interrupted** prompt throughout the group call preemption, even if you no longer hold the **PTT** button.

If your service provider enables the audio notification, your radio plays the **PTT Denied Tone** until you no longer hold the **PTT** button.

#### 3.1.5.1

### Preempting Group Calls

 **NOTE:** Your radio can only support either the D-PTT Tone feature or D-PTT Preempt Group Call feature at a time.

### Procedure:

1. Your radio receives a Group Call.
2. Press the PTT button twice on the radio or the Remote Control Unit (RCU).  
Call preempt is triggered.

### 3.1.6

## Dynamic Group Number Assignment (DGNA)

DGNA allows the network operator to dynamically manage talkgroups on your radio over the air interface. Using DGNA, the network operator can:

- Add talkgroups.
- Attach or select newly added talkgroups.
- Delete talkgroups.
- Modify parameters of existing talkgroups.

All the above operations are performed by transmitting data to your radio.

### 3.1.6.1

## DGNA Reception

When a DGNA message is received, your radio plays a tone and displays a message `Talkgroup list updated`.

When your service provider deletes (de-assigns) the currently selected talkgroup, depending on the settings, your radio can perform one of the following actions:

- Enters the “No Group” state – your radio does not attach to any talkgroup automatically.
- Attaches to the last selected TMO talkgroup. If the last selected TMO talkgroup is not available (it was deleted), your radio enters the “No Group” state.
- Attaches to a default talkgroup configured by your service provider. If the default talkgroup is not available (it was deleted), your radio enters the “No Group” state.

At each talkgroup change, an appropriate notification is shown on the display.

If the DGNA message is received to delete all talkgroups, your radio displays `All Talkgroups Deleted`.

### 3.1.6.2

## DGNA Auto Select Group

If the DGNA Auto Select is configured, whenever your radio receives a DGNA, it switches to the added talkgroup.

### 3.1.6.3

## DGNA Auto Reselect Group

DGNA Auto Reselect allows your radio to return to the previous selected talkgroup. Your network operator assigns a talkgroup to your radio through DGNA. When the assigned talkgroup is deassigned, your radio automatically returns to the previous talkgroup.

### 3.1.7

## Broadcast Call

Broadcast Group Call (also called Site Wide Call) is a high-priority group call from the console operator (or dispatcher) to all users located at one or more sites. The radios are configured to monitor a Broadcast Call, but you cannot talk back. The call can be received as a normal Broadcast Call or an Emergency Broadcast Call. The Broadcast Call preempts an ongoing Group Call that has the same or lower call priority.

In TMO mode, broadcast call can be forwarded from the Gateway to a DMO open talkgroup or Attached DMO Talkgroup if configured.

 **NOTE:** Your radio is only able to receive Broadcast Calls.

## 3.2

# Local Site Trunking

This mode is also known as Fallback Mode and it allows more than one radio from the same site to communicate when the link between the site and the network central controller fails. Entering and exiting Local Site Trunking (that is, returning to System Wide Services) is done automatically. In this mode, some services are unavailable.

 **NOTE:** Your service provider can disable this mode.

### 3.2.1

## Entering Local Site Trunking

When your radio receives a Local Site Trunking indication from the system, the following occurs:

- Your radio sounds an *Entering Local Site Trunking* tone.
- Display shows the `Local Area Service` message.

 **NOTE:** Noticeable only on the color display.

- Any call in progress is dropped upon entering Local Site Trunking Mode.

If configured by your service provider, this message/alert is periodically repeated to remind you that your radio is still operating in Local Site Trunking Mode. The following features are available:

- Registration
- Attachment
- Group Call
- Emergency Operations

 **NOTE:** Your service provider can turn on/off all visual and audio indications, when you enter Local Site Trunking Mode.

### 3.2.2

## Exiting Local Site Trunking

When the link with the central network controller is reestablished, your radio exits Local Site Trunking, and the following occurs:

- Your radio plays an *Exiting Local Site Trunking* tone.
- Any call in progress during Local Site Trunking is dropped.

 **NOTE:** Your service provider can turn on/off all the visual and audio indications, when you exit Local Site Trunking Mode.

### 3.3

## Direct Mode Operation

Direct Mode Operation (DMO) is a mode of simplex operation where radios communicate directly without the need of a network.



**NOTE:** For those who use DMO mode, you are recommended to apply DMO SCK for data confidentiality.

**Figure 16: Direct Mode Operation**

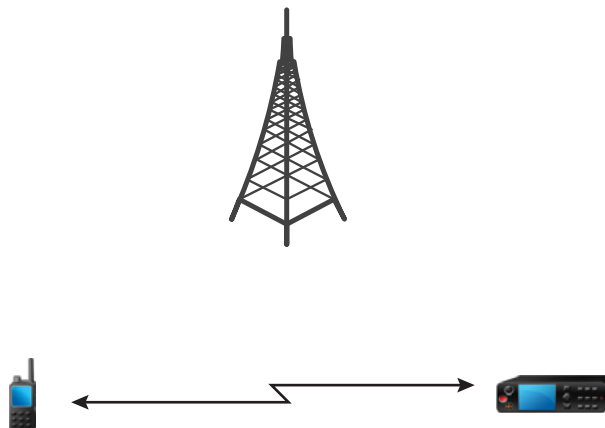

#### 3.3.1

### Entering DMO Mode

**Procedure:**

From the home screen, press the **Menu/OK** key. Select **Networks** → **Direct Mode**.

#### 3.3.2

### Making Group Calls in DMO

The Group Call is received by all members of the selected group who have their units turned on and are in range.

**Procedure:**

1. Press and hold the **PTT** button.
2. Wait for the *Talk Permit* tone (if configured) and then speak into the microphone. Release the **PTT** button to listen.

### 3.3.3

## Receiving Group Calls in Idle

### Procedure:

1. Your radio receives a Group Call.

 **NOTE:** The incoming Group Call is signaled by a *Receiving Group Call* tone.

2. To respond, press and hold the **PTT** button.

### 3.3.4

## D-PTT Preempt Group Call

 **NOTE:** This is a Software Selling Feature.

The D-PTT Preempt Group Call allows superiors to take over and speak in an ongoing group call by making preemptive priority calls.

 **NOTE:** Your radio can only support either the D-PTT Tone feature or D-PTT Preempt Group Call feature at a time.

By pressing the PTT (Push-To-Talk) button twice, you make a preemptive request to temporarily interrupt an ongoing group call and gain permission to speak.

If your group call is preempted and you are still pressing the **PTT** button, your radio displays the **PTT Denied** prompt.

If your service provider enables the visual notification, your radio displays the **PTT Interrupted** prompt throughout the group call preemption, even if you no longer hold the **PTT** button.

If your service provider enables the audio notification, your radio plays the **PTT Denied** Tone until you no longer hold the **PTT** button.

### 3.3.4.1

## Preempting Group Calls

 **NOTE:** Your radio can only support either the D-PTT Tone feature or D-PTT Preempt Group Call feature at a time.

### Procedure:

1. Your radio receives a Group Call.
2. Press the PTT button twice on the radio or the Remote Control Unit (RCU).  
Call preempt is triggered.

### 3.3.5

## Selecting DMO Communications Options

**When and where to use:** Helps to communicate with other radio users on the same talkgroup through the Gateway or Repeater.

### Procedure:

1. From the home screen, press the **Menu/OK** key.
2. Select **Networks** → **DMO Config**.

3. Select one of the following options:

- **MS - MS** – Your radio can communicate only with other radios within its range.
- **Gateway** – Your radio uses a gateway to communicate with the infrastructure.
  - **Automatic** – Your radio uses the first available gateway for that talkgroup.
  - **Specific** – Your radio uses only the Gateway with the specified Gateway address for that talkgroup.
- **Repeater** – Uses the first available repeater for that talkgroup.
- **GW + Rep** – Uses the first available gateway or repeater for that talkgroup.
  - **Automatic** – Uses the first available gateway for that talkgroup.
  - **Specific** – Uses only the Gateway with the specified Gateway address for that talkgroup.



**NOTE:** When the Gateway and the Repeater cannot be communicated even though a talkgroup to use them is configured, the radio attempts the direct MS-MS communication. Your service provider can disable any or all of these options.

**Result:** When your radio detects the appropriate Gateway and/or the Repeater, the Gateway and/or Repeater icons turns solid, respectively.

### 3.3.6

## DMO Private Priority Call

The service provider may assign Pre-emptive Priority to outgoing DMO Private Calls. If this is the case, DMO Private Calls from this radio preempt any ongoing calls (with the exception of emergency calls or ongoing Pre-emptive Priority Private Calls) on the receiving radio, which then displays `Call-preempted`.

### 3.3.7

## Talkgroup for Individual Calls

Talkgroup for Individual Calls is a talkgroup that operates on a separate frequency allocated for individual (private) calls only. Using this talkgroup optimizes frequency resources and helps not to block other talkgroups. The only supported call types are: private calls and emergency calls (both private and group). Use this talkgroup each time you need to make a private call.

When you select a Talkgroup for Individual Calls, your radio is not able to receive or initiate any group or broadcast calls with priority lower than Emergency.

When you have selected a Talkgroup for Individual Calls and press the **PTT** button to start a Group Call, your radio:

- Rejects the call
- Plays a tone
- Displays the `Individual Calls Only` message

### 3.3.8

## Communication through Repeaters

Radios that are out of range and cannot communicate directly with each other in Direct Mode Operation (DMO) can do it through the repeater. The repeater is a radio that repeats all communication on a chosen channel, and as a result increases radios DMO range.



**Figure 17: Communication through Repeaters**

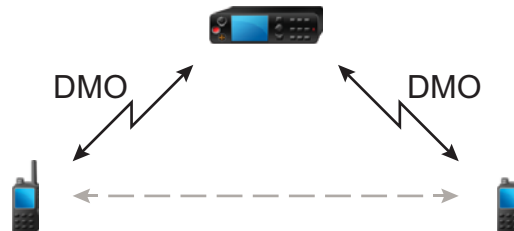

When the radio detects a potential repeater signal or connects to a repeater, it plays a tone, displays the `Repeater available` message, and shows an appropriate icon. When the radio loses connection with the repeater, it plays a tone, displays the `Repeater not available` message, and the repeater icon is blinking.

When the radio is on a Gateway mode, radio switches to Gateway mode from TMO if the radio enters emergency.

Powering off the radio or exiting the Gateway mode is restricted when gateway is forwarding emergency call.

### 3.3.9

## Communication Through Gateways

Gateway provides connectivity between radios operating in Direct Mode Operation (DMO) and the TETRA network, so that the DMO radios can communicate with radios operating in Trunked Mode Operation (TMO).

**Figure 18: Communication Through Gateways**

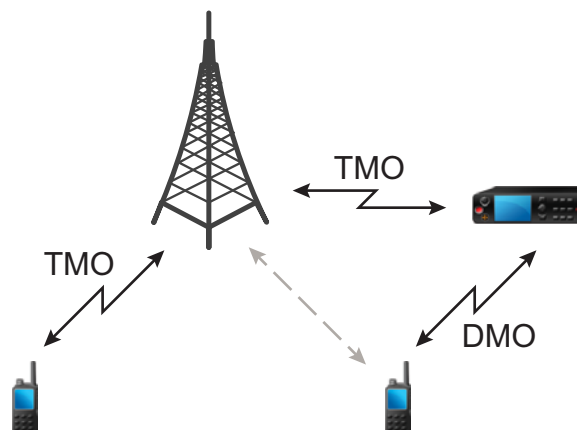

**Radio behavior when radio detects a potential repeater signal or connects to a gateway:**

- Radio sounds a tone sounds.

- Radio displays `Gateway available`.
- Radio displays an appropriate icon.

**Radio behavior when radio loses connection with the gateway:**

- Radio sounds a tone.
- Radio displays `Gateway available`.
- Radio displays an appropriate icon.

**Radio behavior when group call is in queue:**

- Radio displays `Please Wait`.

**Radio behavior when entering Local Site Trunking:**

- Radio sounds a tone.
- Radio displays `Local Area Service`.

### 3.3.10

## Gateway and Repeater Synchronization

To communicate using gateways or repeaters, the radio requires synchronization with a gateway or a repeater.

A gateway or a repeater sends presence signals to radios. If a radio receives presence signals, it stays synchronized with the gateway or the repeater which sends the signals. If a radio fails to receive a presence signal it does not immediately lose synchronization. The radio waits for another successful presence for a time defined by your service provider. This function ensures that communications are not dropped due to temporary reception issues.

If a gateway or a repeater is unavailable or the radio is not synchronized with a gateway or a repeater, depending on the setup configured by your service provider, the following scenarios apply:

- The radio falls back to Direct Mode Operation (DMO).
- After pressing the **PTT** button, a prompt appears warning that the second press overrides the gateway or repeater operation mode.
- No direct DMO communications are permitted.

In the second scenario, while the radio receives individual calls and group calls, and replying to individual calls is possible, replying to group calls is not possible.

### 3.4

## Transmit Inhibit Mode

The Transmit Inhibit (TXI) Mode is a mode in which the radio sends no radio transmissions. Activate this mode in RF sensitive areas, for example hospitals, airplanes, where safety can be jeopardized due to transmission radiation.

To activate, select **Menu/OK** → **Networks** → **TXI Mode** → **Activate**.

In this mode, the radio does not transmit under any circumstances except for the Emergency Calls. All the functions and keys which cause transmission, for example registration to the network, changing talkgroup or folder, or pressing the **PTT** button are disabled. Any transmission trial causes the radio to display `Not Allowed In TXI Mode` notification and to play a tone. Your radio can still receive group calls.

When no danger to safety exists anymore, for example, when you leave the RF sensitive area, you can deactivate the TXI Mode and the radio returns to standard operation.

You can deactivate the mode by selecting **Menu/OK** → **Networks** → **TXI Mode** → **Deactivate**, or implicitly when initiating an Emergency Call.



**NOTE:** RF Transmissions from the radio are prevented under the following conditions:

- TXI Mode is activated.
- Battery is removed.
- The radio is turned off.

On entering or exiting the TXI mode, when the radio is camped on a cell, it sends a specially designated Short Data Service (SDS) status message. This SDS message indicates to the SwMI that the radio is entering or exiting TXI mode.

Mobility procedures that do not require the radio to send an uplink transmission are performed except for cell reselection.

In TXI mode, the radio joins group calls for any group that the radio is monitoring, but the transmitting on that call is still prohibited.

If you initiate an emergency call, the radio immediately leaves TXI mode and attempts to start the emergency call if the radio is in service.

If the radio is turned off in the transmit inhibit mode, on turning on the radio asks whether to exit the transmit inhibit mode. If you press the **Back** touch icon, the radio turns off.

### 3.5

## Emergency Operations

Emergency Operations are used in critical situations.

Pressing and holding the **Emergency** button activates one or more services (depending on your service provider settings).

When starting Emergency Operations, any ongoing voice call is aborted or cleared down.

During Emergency Operations, the radio rejects phone, PABX, and private calls, and does not monitor the talkgroups in the selected scan list.

To terminate Emergency Operations, press and hold the **Back** key.

#### 3.5.1

### Emergency Alarm

The Emergency Alarm is a special status message. Your radio sends the message in either TMO or DMO.

Your radio sends the message each time it enters Emergency Operation. An audible tone sounds for a successfully sent message. To resend the message, press the **Emergency** button.

Emergency Alarm in DMO mode can be configured to send in all DMO modes or when your radio is synced through Gateway.



**NOTE:** During Hot Microphone transmission, your radio is not allowed to resend the message.

#### 3.5.2

### Emergency Group Call

The Emergency Group Call has the highest communication priority and it is a pre-emptive call. Emergency Group Call is available in both TMO and DMO. During Emergency Operations, start Emergency Group Call

by pressing the **Emergency** button. Your radio can also support Hot Microphone operation, which allows the Emergency Call to be conducted without pressing the **PTT** button.

When a radio receives or generates a group call with emergency priority, the display shows the talkgroup ID and the emergency icon is displayed. A special *alert* tone is played.

An emergency group call can be configured as:

- A non-tactical call – initiated on a talkgroup preprogrammed by your service provider. When in non-tactical emergency mode, you cannot switch talkgroups.
- A tactical call – initiated on the currently selected talkgroup.

Pressing the **Emergency** button during an ongoing emergency broadcast call has no effect. No new call is started and no emergency alert is sent.

When the Emergency Group Call you participate in terminates, your radio can behave in several ways, depending on your service provider settings:

- If you are the call initiator, the radio can either stay in the Emergency Mode, or return to TMO.
- If you are not the call initiator, the radio always returns to TMO.

### 3.5.2.1

## Making Emergency Group Calls

**Prerequisites:** Ensure that your radio is in Emergency Mode.

**Procedure:**

1. Press and hold the **PTT** button.
2. Wait for the *talk permit* tone (if configured) and talk.
3. Release the **PTT** button to listen.



**NOTE:** It is possible to cancel making an emergency group call in TMO. To do this, press the **Back** key.

### 3.5.2.2

## Receiving Emergency Group Calls

The radio receives an Emergency Group Call from a selected pre-programmed group. An appropriate tone and status icon indicates an incoming call.

### 3.5.3

## Non-Tactical Emergency

In Non-Tactical Emergency, your radio switches to a designated Emergency talkgroup when starting Emergency Operations. This talkgroup is used for the complete duration of the Emergency Operation. Changing talkgroups is not allowed at this point.

In Trunked Mode Operation (TMO), your radio can make Emergency Non-Tactical Group Calls without sending attachments. If configured, the radio assumes implicit attachments after receiving a temporary address.

In Direct Mode Operation (DMO), the Non-Tactical Emergency proceeds on the same frequency as the previously selected talkgroup. The service provider can designate any Individual TETRA Subscriber Identity (ITSI) address to be used for Emergency Operations. This ITSI can be an Open Group - broadcast address.

After exiting from Non-Tactical Emergency, your radio returns to the previously selected talkgroup.

### 3.5.4

## Emergency Individual Calls (Private or MSISDN)

The Emergency Individual Calls are simplex or duplex calls with emergency priority.

On pressing the **Emergency** button, your radio initiates an individual call to a provisioned private or Mobile Station Integrated Services Digital Network (MSISDN) address.

This feature also supports the direct or hook dialing method on simplex and duplex calls. For full duplex Emergency Individual Calls initiated to an MSISDN address, the default dialing method is configured to hook. This default dialing method cannot be modified.

In Emergency Individual Calls, your radio rejects all incoming individual calls with non emergency priority. These rejected calls are shown as missed calls after the Emergency Individual Calls have ended.

Emergency Full Duplex Private Calls (FDPC) supports high/low audio state. The audio state is configurable. You can select the audio state during incoming or outgoing emergency FDPC by toggling hi or low audio during active Emergency FDPC.

### 3.5.5

## Emergency SDS Status

The radio sends a status message with a preprogrammed value to the destination address set by your service provider. Emergency SDS Status is available in TMO only. If no status acknowledgment or negative acknowledgment is received, the radio retries sending the message. Status is not resent when Emergency Alarm is configured.

### 3.5.6

## Emergency Hot Microphone

The Hot Microphone allows you to talk without pressing the **PTT** button during Emergency Operation. The transmission continues for a provisioned amount of time. If configured, pressing the **PTT** button before the Hot Microphone time expires ends the Hot Microphone operation. Then normal PTT operation in Emergency group call takes over whereby the transmission is ongoing for the time the **PTT** button is held.

Subsequent **Emergency** button presses during the Emergency Operation restart the Hot Microphone transmission.

If a talk permit is granted to another member of the group, the Emergency Call received tone is played. If configured, the radio automatically attempts to get talk permit again.

Pressing the **Back** touch icon ends the Hot Microphone operation.

### 3.5.7

## Alternating Hot Microphone

The Alternating Hot Microphone is an enhancement of the Hot Microphone. After activation, the radio alternately enters transmission phases (your microphone is active) and reception phases (you can only listen) for an amount of time precisely determined by your service provider.

If this feature is enabled, you can initiate the Alternating Hot Microphone by pressing the **Emergency** button. If you want to finish earlier or skip the transmission phase, press the **Back** key.

The Alternating Hot Microphone terminates when one of the following conditions is met:

- The radio exits the Emergency Mode.
- The Alternating Hot Microphone timer expires.

- The **PTT** button is pressed (if configured).



**NOTE:** When the radio goes out of the service, it enters the reception phase and the Alternating Hot Microphone is on hold. When the radio is back to the service, the Hot Microphone transmission and the Alternating Hot Microphone resume.

When you are in the Emergency Mode, pressing the **Emergency** button restarts the Alternating Hot Microphone.

### 3.5.8

## Invisible Emergency

Your service provider can disable visual and audible indications on the radio in Emergency Operation. This feature is called Invisible Emergency. Invisible Emergency provides an extra layer of safety when using Emergency Operation in critical situations. Critical situations are such as a direct attack on the user.

### 3.5.9

## Emergency Mode by Dialing

This feature allows you to trigger Emergency Mode by dialing a predefined number. It initiates the same emergency services as when you use the **Emergency** button. Your radio can store up to eight emergency numbers.



**NOTE:** If Emergency Mode is triggered by dialing an emergency number, you can press the **Back** key to exit Emergency Mode.

### 3.5.10

## Emergency Destination in Local Site Trunking



**NOTE:** This is a Software Selling Feature.

This feature allows the radio to send emergency requests to a different destination. This transmission occurs while in local site trunking mode.

The supported emergency services are:

- Emergency Alarm
- Emergency Call
- Emergency Short Data Service (SDS) Status
- Location Information Protocol reports

### 3.5.11

## Exiting Emergency Operations

**Prerequisites:** Make sure that your radio is engaged in Emergency Operations.

**Procedure:**

Press the **Back** key.

**Result:** Your radio exits Emergency Operations.

## Chapter 4

# Main Menu

This chapter contains information on items in the main menu.



**IMPORTANT:** Ensure the Menu Configuration is enabled on the CPS to allow the menu settings to be visible on the radio MMI.

### 4.1

## Scrolling through the Menu

### Procedure:

1. From the home screen, press the **Menu/OK** key.
2. Scroll to the required item using Navigation keys. Press **Menu/OK** to select.







If the menu item contains a further set of menu items, repeat [step 2](#). Use the **Back** key to return to the previous menu.









### 4.2

## Menu Icons

The following icons make it easy to identify the menu items at first glance.

**Table 13: Menu Icons**

Menu Icon	Description
	<p><b>Main Menu Items/Context Sensitive Menu</b> It is assigned to <b>Menu</b> when the main menu items/context-sensitive menu are active.</p>
	<p><b>Dialer</b> Allows you to dial a number to initiate a private, phone, or Private Automatic Branch Exchange (PABX) call. The default icon shown is the private call icon. This icon changes as you change the call type.</p>
	<p><b>Messages</b> Send status messages.  Send text messages (free text or according to user defined or predefined templates).  Received messages in <b>Inbox</b>.</p>
	<p><b>Talkgroup</b> View and select pre-set talkgroups.</p>
	<p><b>Favorite Talkgroup</b> View and select pre-set favorite talkgroups.</p>
	<p><b>Contacts</b> Search for entries in the contact list.</p>

Menu Icon	Description
	<b>Favorite Contacts</b> Search for pre-set favorite entries in the contact list.
	<b>Bluetooth</b> Allows you to manage Bluetooth settings.
	<b>Bluetooth Devices</b> Allows you to manage Bluetooth devices.
	<b>Scan</b> Allows you to activate/deactivate scanning and view scan list.
	<b>Man Down (henceforth known as Fall Alert)</b> Allows you to activate the Man Down (Fall Alert) feature.
	<b>Security</b> Lets you turn on/off and verify security features, and change passwords.
	<b>Setup</b> Allows you to customize your radio.
	<b>Networks</b> Allows you to select a network.
	<b>Location</b> Allows you to enable or disable GNSS.

### 4.3

## Dialer

This menu item allows you to dial a number to initiate a private, phone, or Private Automatic Branch Exchange (PABX) call. You can also enter the dialing editor by pressing a pre-configured One-Touch Button.

See [ST7500 Controls and Indicators on page 26](#) for the keys' functions to dial a number.

Similar to the icons used in [Contacts on page 70](#), the Private, Phone, or PABX icon indicates the selected type of call.

Pressing and holding the **Menu/OK** key in the dialing editor invokes the dialing menu. Depending on your operating mode and the type of call, the following options are available in the dialing menu:

- **Call** – initiates a duplex call in Trunked Mode Operation (TMO).
- **E2E** – If enabled, this field allows you to enable or disable encryption.
- **Hook Method** – If enabled, this field allows you to select the required call type and hook method for a private call.

#### 4.3.1

## Making Private Calls

### Procedure:

1. From the home screen, press the **Menu/OK** key.
2. Select **Dialer** and enter a number.
3. If **Private** is not the first type of call presented, press the **P2** or **P3** programmable button repeatedly to select it.



- Depending on the mode, perform one of the following actions:

Option	Actions
If you are making simplex calls in TMO or DMO,	<ol style="list-style-type: none"> <li>Press the <b>PTT</b> button.</li> <li>Wait for the Talk Permit tone before talking.</li> </ol>
If you are making duplex calls in TMO,	<ol style="list-style-type: none"> <li>Press and hold the <b>Menu/OK</b> key.</li> <li>Select <b>Call</b>. You hear a ringing tone until the called party answers the call.</li> </ol>

- To end the call, press the **Back** key.

#### 4.3.2

## Making Phone or PABX Calls

**Prerequisites:** This feature is only available in Trunked Mode Operation (TMO).

**Procedure:**

- From the home screen, press the **Menu/OK** key.
- Select **Dialer** and enter a number.
- If **Phone** or **PABX** is not the first type of call presented, press the **P2** or **P3** programmable button repeatedly to select it.
- Depending on the mode, perform one of the following actions:

Option	Actions
If you are making a MSISDN Simplex Call,	<ol style="list-style-type: none"> <li>Press the <b>PTT</b> button.</li> <li>Wait for the Talk Permit tone before talking.</li> </ol>
If you are making a PABX or PSTN Call,	<ol style="list-style-type: none"> <li>Press and hold the <b>Menu/OK</b> key.</li> <li>Select <b>Call</b>. You hear a ringing tone until the called party answers the call.</li> </ol>

- To end the call, press the **Back** key.

#### 4.4

## Messages

The messages feature allows you to send and receive text messages. A message can contain up to 1000 characters, depending on your service provider settings.

Pressing the **PTT** button when a message is highlighted can cause one of the following actions, depending on your service provider settings:

- The radio ignores the **PTT** button request.
- The radio starts a Private Call with the message sender.
- The radio starts a Group Call on a currently selected talkgroup.

#### 4.4.1

## New Message

This menu item allows you to create a new message.

See [Writing Text on page 29](#) for text entry method on your radio.

#### 4.4.1.1

## Sending Messages to Private or Phone

### Procedure:

1. From the home screen, press the **Menu/OK** key.
2. Select **Messages** → **New Message**.
3. Enter your message.
4. Press and hold the **Menu/OK** key, and select **Send**.
5. Select **Send to Private** or **Send to Phone**.
6. Perform one of the following options:

Option	Actions
If the number of the recipient is displayed,	press and hold the <b>Menu/OK</b> button.
If the number of the recipient is not displayed,	perform the following actions: <ol style="list-style-type: none"><li>a. Press and hold the <b>Menu/OK</b> button.</li><li>b. Select a contact from the contact list.  <b>NOTE:</b> The radio displays the number of the contact.</li><li>c. Press and hold the <b>Menu/OK</b> button.</li></ol>

#### 4.4.1.2

## Sending Messages to Groups

### Procedure:

1. From the home screen, press the **Menu/OK** key.
2. Select **Messages** → **New Message**.
3. Enter your message.
4. Press and hold the **Menu/OK** key.
5. Select **Send** → **Send to Group**.
6. Select a group that you want to send the message to.

#### 4.4.1.3

## Sending Store and Forward Messages

**Prerequisites:** Ensure that your service provider enables the Store and Forward feature.

### Procedure:

1. From the home screen, press the **Menu/OK** key.

2. Select **Messages** → **New Message**.
3. Enter your message.
4. Press and hold the **Menu/OK** button.
5. Select **Message Setup** and choose one of the following options.
  - **Online User**
  - **On/Offline Usr**
6. Select **Send**.
7. Select one of the following options:
  - **Send to Private**
  - **Send to Phone**
8. Perform one of the following options:

Option	Actions
If the number of the recipient is displayed,	press and hold the <b>Menu/OK</b> button.
If the number of the recipient is not displayed,	perform the following actions: <ol style="list-style-type: none"> <li>a. Press and hold the <b>Menu/OK</b> button.</li> <li>b. Select a contact from the contact list.</li> <li>  <b>NOTE:</b> The radio displays the number of the contact.               </li> <li>c. Press and hold the <b>Menu/OK</b> button.</li> </ol>

#### 4.4.1.4

### Delivery Report

You can configure the radio to request an acknowledgment (Delivery Report), upon sending a message to an individual recipient. You can define the type of Delivery Report your radio requests, or turn this feature on and off.

If the radio receives the Delivery Report shortly after the message is sent, the radio displays the following results:

- Displays one of the following notifications:

**Table 14: Description of Delivery Report Notification**

Notification	Description
Message Sent	A Delivery Report is not requested and a Store and Forward message is received in the Store and Forward server.
Message Delivered	A Delivery Report is requested and the recipient receives the message.
Message Read	The <b>Consumed</b> Delivery Report is requested and the recipient opens the message.
Message Failed	The Delivery Report is requested and the recipient does not receive the message within the stipulated time.

- Saves the Delivery Report and a copy of the message in the **Outbox**.

If the radio receives the Delivery Report after a longer period, the radio saves the Delivery Report and a copy of the message in the **Outbox**.

If the radio receives the Delivery Report after a longer period and your service provider configures the functionality of the Delivery Report Notifications, the radio displays the following results:

- Saves the Delivery Report and a copy of the message in the **Outbox**.
- Temporarily saves the Delivery Report message in the **Inbox**. The notification disappears after it is read.
- Displays the New Message icon.
- Displays the New Delivery Status notification screen (if possible).

#### 4.4.1.4.1

### Viewing Delivery Reports

**Procedure:**

1. From the home screen, press the **Menu/OK** key.
2. Select **Messages** → **Inbox**.
3. Select the required message and press the **OK** button.
4. Select **Delivery Status**.

#### 4.4.1.4.2

### Configuring Delivery Reports

**Prerequisites:** Ensure that your service provider enables the delivery report configuration.

**Procedure:**

1. From the home screen, press the **Menu/OK** key.
2. Select **Messages** → **New Message**.
3. Enter your message.
4. Press and hold the **Menu/OK** key and select **Delivery Report**.
5. Depending on the report option that you want to use, select one of the following options:









Option	Description
<b>None</b>	No delivery reports are required.
<b>Received</b>	Delivery reports are required when the recipient receives your messages.
<b>Consumed</b>	Delivery reports are required when the recipient reads your messages.
<b>Both</b>	Delivery reports are required when the recipient receives and reads your messages.

#### 4.4.2

## Inbox

The inbox folder contains up to 100 new or old incoming messages, depending on the length of the messages. The **Messages** sub-menu indicates the number of the messages. For example, if the indication is 2/4, it means that two unread and four read messages are in the inbox.

**Table 15: Inbox Icons**

Icon	Description
	Unread (New) Message
	Read (Old) Message
	Unread (New) Protected Message
	Read (Old) Protected Message
	Unread (New) Encrypted Message
	Read (Old) Encrypted Message
	Unread (New) Encrypted and Protected Message
	Read (Old) Encrypted and Protected Message

#### 4.4.2.1

### Receiving New Messages

When you receive a new message, your radio displays the New Message icon. You can view the new message in the Inbox folder.

#### 4.4.2.2

### Opening the Inbox

**Procedure:**

1. From the home screen, press the **Menu/OK** key.
2. Select **Messages** → **Inbox**.

The radio displays the status of the inbox for a few seconds (if any):

- No New or Old Messages
- Inbox Full



#### 4.4.2.3

### Using Submenus in Inbox and Outbox

**Procedure:**

1. From the home screen, press the **Menu/OK** key.

2. Select **Messages** → **Inbox** or **Outbox**.
3. Select the required message and press the **Menu/OK** button.
4. Use the submenus for the following options:

Option	Actions
Deleting messages	<ol style="list-style-type: none"> <li>a. Select <b>Delete</b>.</li> <li>b. To confirm, select <b>Yes</b>.</li> </ol>
Deleting all messages from the inbox or outbox	<ol style="list-style-type: none"> <li>a. Select <b>Delete All</b>.</li> <li>b. To confirm, select <b>Yes</b>.</li> </ol>
Invoking the edit screen with the original message as default text, and the message originator as a recipient	<ol style="list-style-type: none"> <li>a. Select <b>Reply</b> and edit the text.</li> <li>b. To send, press and hold the <b>Menu/OK</b> button and then select <b>Send</b>.</li> </ol> <p> <b>NOTE:</b> This option is only applicable for the inbox.</p>
Invoking the edit screen with previously entered text to the same recipient	<ol style="list-style-type: none"> <li>a. Select <b>Resend</b> and edit the text.</li> <li>b. To send, press and hold the <b>Menu/OK</b> button and then select <b>Send</b>.</li> </ol>
Invoking the edit screen with an old message and sending it to a different recipient	<ol style="list-style-type: none"> <li>a. Select <b>Forward</b> and edit the text.</li> <li>b. To send, press and hold the <b>Menu/OK</b> button and then select <b>Send</b>.</li> </ol>
Displaying the date and time of the message when it is in one of the following status: <ul style="list-style-type: none"> <li>● Sent</li> <li>● Delivered</li> <li>● Read</li> <li>● Expired and undelivered</li> <li>● Expired and unread</li> <li>● Failed due to an unknown error</li> </ul>	Select <b>Delivery Status</b> . <p> <b>NOTE:</b> This option is only applicable for the outbox.</p>
Protecting the message from being deleted or overwritten	Select <b>Protect</b> .
Removing the message protection	Select <b>Unprotect</b> . <p> <b>NOTE:</b> Message protection is enabled in the inbox. You can only delete unprotected messages.</p>
Displaying the status of the Store and Forward feature	Select <b>Msg. Details</b> .

#### 4.4.2.4

### Embedded Number

The Embedded Number feature allows you to call a number embedded in the message in the Inbox or Outbox folder. You can also start a group call with the message sender of a talkgroup.

#### 4.4.2.5

### Calling Numbers from Messages

The Embedded Number feature is enabled by your service provider. You can return a voice call to the sender of a message or to any number that is embedded in the message text.

#### Procedure:

1. From the home screen, press the **Menu/OK** key.
2. Select **Messages** → **Inbox**.
3. Select the required message.
4. Press the **PTT** button.  
The radio displays a list of numbers, including the number of the sender.
5. Scroll to the required number and press the **PTT** button.
6. Press the **P2 Programmable** button to select one of the following type of calls:
  - **Private**
  - **Phone**
  - **PABX**
7. Press the **PTT** button to initiate the call.

#### 4.4.2.6

### Making Group Calls on the Talkgroup of the Message Sender

The Embedded Number feature is enabled by your service provider.

#### Procedure:

1. From the home screen, press the **Menu/OK** key.
2. Select **Messages** → **Inbox**.
3. Select the required message and press the **PTT** button.





#### 4.4.3

### Outbox

The outbox stores up to 100 sent messages that are arranged chronologically.

Table 16: Outbox Icons

Icon	Description
	Delivery in Progress
	Delivery Accomplished

Icon	Description
	Delivery Failed
	Protected Message Delivery In Progress
	Protected Message Delivery Accomplished
	Protected Message Delivery Failed
	Encrypted Message Delivery In Progress
	Encrypted Message Delivery Accomplished
	Encrypted Message Delivery Failed
	Encrypted and Protected Message Delivery In Progress
	Encrypted and Protected Message Delivery Accomplished
	Encrypted and Protected Message Delivery Failed

#### 4.4.3.1

### Opening the Outbox

#### Procedure:

1. From the home screen, press the **Menu** key.
2. Select **Messages** → **Outbox**.

The radio displays the status of the outbox for a few seconds (if any):

- No Messages
- Outbox Full – This status is displayed if it is enabled by your service provider.

#### 4.4.4

### Call-Out (CO) Box

**CO Box** contains incoming and outgoing Call-Out messages.

Clicking **Menu/OK** on a Call-Out message headline displays more detailed information on the item.







When the radio is in normal mode, you are able to browse through all messages in the **CO Box**. However, if the radio is in the Call-Out mode, you can only browse through the information regarding the currently ongoing Call-Out message.



#### 4.4.4.1

## Call-Out Icons

Table 17: Call-Out Icons

Icon	Description
	Read (Old) Call-Out Message in Inbox
	Unread (New) Call-Out Message in Inbox
	Read (Old) Protected Call-Out Message in Inbox
	Unread (New) Protected Call-Out Message in Inbox
	Read (Old) Call-Out Message in Outbox
	Read (Old) Protected Call-Out Message in Outbox

#### 4.4.4.2

## Responding to Call-Out Messages

When a Call-Out message is received and acknowledgment is required, you can respond to the message.

**Prerequisites:** A **Call-Out** prompt with user receipt pops-up on your radio display.

### Procedure:

1. Select one of the following options:

- **Accept**
- **Standby**
- **Reject**
- **Messages**
- **Exit**

 **NOTE:** **Exit** is only available after you have responded to the prompt with **Accept** or **Standby**.

Selecting **Accept**, **Standby**, or **Reject** sends user acknowledgment back to the initiator.

2. To respond to the Call-Out with a predefined message, select **Messages** → **Send Message** → **CO Templates**.

 **NOTE:** Depending on the settings configured by your service provider, you can respond to the Call-Out message with free text by selecting **Messages** → **Send Message** → **Editor**.

3. Select the required template.
4. Press the **Menu/OK** key, and select **Send**.

#### 4.4.5

## Templates

A template box stores user-defined message templates.

#### 4.4.5.1

### Sending User-Defined Templates

**Procedure:**

1. From the home screen, press the **Menu/OK** key.
2. Select **Messages** → **Templates**.
3. Select the required template.
4. Press the **Menu/OK** key and select **Send**.
5. Press and hold the **Menu/OK** key and select a contact.
6. Send the message by pressing the **Menu/OK** key.

#### 4.4.5.2

### Managing User-Defined Templates

**Procedure:**

1. From the home screen, press the **Menu/OK** key.
2. Select **Messages** → **Templates**.
3. Select the required template.
4. Press the **Menu/OK** button and select **Edit**.

#### 4.4.6

### Predefined Templates

Predefined message templates are programmed into your radio.

You are allowed to perform limited edit operations on the predefined template. You can send it, but you cannot store the edited template or erase it from the predefined template list.

#### 4.4.6.1

### Viewing Predefined Templates

**Procedure:**

1. From the home screen, press the **Menu/OK** key.
2. Select **Messages** → **Predefined**.
3. Select the required template.

#### 4.4.6.2

### Sending Predefined Templates

**Procedure:**

1. From the home screen, press the **Menu/OK** key.
2. Select **Messages** → **Predefined**.
3. Select the required template.

4. Perform one of the following actions:

Option	Actions
If you want to send the predefined template,	press the <b>Menu/OK</b> key and select <b>Send</b> .
If you want to edit and send the predefined template,	perform the following actions: <ol style="list-style-type: none"> <li data-bbox="878 394 1406 428">a. Press the <b>Menu/OK</b> key and select <b>Edit</b>.</li> </ol> <div data-bbox="930 443 976 495" style="display: inline-block; vertical-align: middle;">  </div> <div data-bbox="987 443 1401 537" style="display: inline-block; vertical-align: middle;"> <p><b>NOTE:</b> The edit screen opens with the template text. You are only allowed to replace the existing text.</p> </div> <ol style="list-style-type: none"> <li data-bbox="878 548 1417 611">b. Press and hold the <b>Menu/OK</b> key to send the message.</li> </ol>

#### 4.4.7

## Status Messages

The radio allows you to send two types of status messages: statuses and targeted statuses. Your service provider determines which type is enabled on the radio.

Statuses can be sent either to a selected talkgroup or to a private number programmed by your service provider. Targeted statuses can be sent to any talkgroup defined for the radio or to any private number that is from the contact list or entered manually.

#### 4.4.7.1

### Viewing a Status Message Number

#### Procedure:

1. From the home screen, press the **Menu/OK** key.
2. Select **Messages** → **Send Status**.
3. Select the required status message to view the number.

#### 4.4.7.2

### Sending Status Messages

You can send status messages to either a selected talkgroup or a programmed private number. Only one option can be enabled at a time.

#### Prerequisites:

- If sending statuses to talkgroups is enabled, switch to the talkgroup to which you want to send a status message.
- If sending statuses to private numbers is enabled, no action is needed. The private number is set up by your service provider.

#### Procedure:

1. From the home screen, press the **Menu/OK** key.
2. Select **Messages** → **Send Status**.
3. Select the required status message.
4. Press the **Menu/OK** key and select **Send**.

#### 4.4.7.3

## Targeted Status Messages

The Targeted Status Messages feature enables sending status messages to addresses that can be selected by the user.

By default, targeted status messages can be sent to private or talkgroup addresses.

Your service provider can restrict valid addresses to numbers stored in **Contacts**.



**NOTE:** This feature is not supported on Dimetra networks.

#### 4.4.7.3.1

### Sending Targeted Status Messages

#### Procedure:

1. From the home screen, press the **Menu/OK** key.
2. Select **Messages** → **Send Status**.
3. Select the required status message and press the **Menu/OK** key.
4. Do one of the following:
  - Enter the number and press and hold the **Menu/OK** key. Select **Send**.
  - Select the required talkgroup from the **TalkGroup List**.

**Result:** The display shows one of the following delivery reports:

- Status Sent
- Status Failed

#### 4.4.8

## Additional Address

The Additional Address feature allows the radio to send Radio Messaging System (RMS) messages and Local Information Protocol (LIP) reports to additionally defined recipients.

The default addresses for the RMS messages and LIP reports are defined by your service provider. RMS messages and LIP reports are also sent to selected and enabled additional address.

#### 4.4.8.1

### Enabling or Disabling Additional Address

#### Procedure:

1. From the home screen, press the **Menu/OK** key.
2. Select **Messages** → **Add. Address** → **Enable**.
3. Select one of the following options:
  - To activate the feature, select **On**.
  - To deactivate the feature, select **Off**.

#### 4.4.8.2

### Selecting Additional Address

#### Procedure:

1. From the home screen, press the **Menu/OK** key.
2. Select **Messages** → **Add. Address** → **Select Address**.  
The radio displays a list of aliases.
3. Scroll to the required alias and press the **Menu/OK** key.

#### 4.4.9

### Call-Out Availability



**NOTE:** This feature is only available when enabled by your service provider.

This menu item enables or disables the Call-Out availability.

#### 4.4.9.1

### Setting Call-Out Availability

#### Procedure:

1. From the home screen, press the **Menu/OK** key.
2. Select **Messages** → **Call-Out Availability**.
3. Select one of the following options:
  - **Available**
  - **Not available**

#### 4.5

### Favorite Contacts

This menu stores your favorite contacts from the Contacts menu. A contact that has multiple numbers is listed out as multiple entries in the My Contacts menu. Each entry is differentiated by the Contact Type icons (see [Table 18: Contact Types on page 70](#) for the icon types).

#### 4.5.1

### Dialing through the Favorite Contacts List

#### Procedure:

1. From the home screen, press the **Menu/OK** key.
2. Select **My Contacts**.
3. To highlight the required contact, use **Up** and **Down** Navigation keys.



**NOTE:** The type icon in front of the contact denotes the contact number type.

4. To initiate a simplex call, press the **PTT** button. Otherwise use the **Menu/OK** key to initiate a duplex call.

## 4.6

# Contacts

This feature is only available when enabled by your service provider. This menu stores all your contact numbers pre-set by your service provider.

Each contact entry requires the following information:







### Name

Shows the name for a contact pre-set by the service provider.

### Type

Each contact is assigned to one of the following types:

**Table 18: Contact Types**

Contact Icon	Description
	Private
	Mobile
	Home
	Work
	PABX
	Other

### # (number)

Number for the contact pre-set by the service provider.

### Speed #

#### Simplex (Private only)

Shows the hook method for simplex calls.

#### Duplex (Private only)

Shows the hook method for duplex calls.

## 4.6.1

# Dialing through the Contact List

### Procedure:

1. From the home screen, press the **Menu/OK** key.
2. Select **Contacts**.
3. To highlight the required contact, use **Up** and **Down** Navigation keys.
4. If the contact has more than one number, use **Up** and **Down** Navigation keys to select the required number.
5. To initiate a simplex call, press the **PTT** button. Otherwise use the **Menu/OK** key to initiate a duplex call.

## 4.7

# Talkgroup

This menu allows you to view and select active talkgroup.

### 4.7.1

## Selecting Favorite Talkgroup

The Favorite Talkgroup consists of DMO/TMO talkgroups pre-set by the service provider.

#### Procedure:

1. From the home screen, press the **Menu/OK** key.
2. Select **Favorite TGs** → **Select TGs**.  
List of all talkgroups is displayed.
3. Select the required talkgroup and press **Menu/OK**.

**Result:** Your radio displays a notification of the selected talkgroup.

### 4.7.2

## Editing Talkgroups in Favorite Folder

This menu allows you to add or delete the pre-set talkgroups in the Favorite Folder.

**Prerequisites:** Ensure your service provider enables editing folder option.

#### Procedure:

1. From the home screen, press the **Menu/OK** key.
2. Select **Favorite TGs** → **Edit TGs**.
3. Select one of the following options:

Option	Actions
To add talkgroup	<ol style="list-style-type: none"> <li>a. Select <b>Add Item</b>.</li> <li>b. Search for the required talkgroup. Use <b>Menu/OK</b> to confirm selection.</li> </ol>
To delete a talkgroup	<ol style="list-style-type: none"> <li>a. Navigate to the required talkgroup. Press <b>Menu/OK</b>.</li> <li>b. Select <b>Delete</b>.</li> <li>c. Press <b>Menu/OK</b> at the confirmation notification to confirm deletion.</li> </ol>
To delete all talkgroups	<ol style="list-style-type: none"> <li>a. Select any talkgroup. Press <b>Menu/OK</b>.</li> <li>b. Select <b>Delete ALL</b>.</li> <li>c. Press <b>Menu/OK</b> at the confirmation notification to confirm deletion of all talkgroups.</li> </ol>

**Result:** Your radio displays a notification of the added or deleted talkgroup.

### 4.7.3

## Setting Talkgroup Folders

This menu consists of talkgroup folders pre-set by the service provider.

### Procedure:

1. From the home screen, press the **Menu/OK** key.
2. Select **TGs Folders**.
3. Select the required folder and press **Menu/OK** key.



**NOTE:** You can use the **Talkgroup Selector** button to scroll through the talkgroups of selected folder.

4. To change to another folder, press the button on the RCU. Select the required folder and press the button on the RCU.

### 4.7.4

## Changing the Talkgroup Folders using RCU

### Procedure:

1. Press the button on the RCU.
2. Select the required folder and press the button on the RCU.

### 4.7.5

## Selecting Extended Folders Talkgroup

This menu consists of extended talkgroup folders pre-set by the service provider.

### Procedure:

1. From the home screen, press the **Menu/OK** key.
2. Select **Extended Folders** → **Select TGs**.
3. Select the required folder.
4. Select the required Talkground listing and press the **Menu/OK** key.



**NOTE:** Your radio can access up to four levels of the extended folder structure. You can use the **Talkgroup Selector** button to scroll through the talkgroups of selected folder.

**Result:** Your radio displays a notification of the selected talkgroup.

### 4.7.6

## Editing Extended Folders Talkgroup

This menu allows you to add or delete the pre-set talkgroups in Extended Folders.

**Prerequisites:** Ensure your service provider enables editing folder option.

### Procedure:

1. From the home screen, press the **Menu/OK** key.
2. Select **Extended Folders** → **Edit TGs**.



3. Select one of the following options:

Option	Actions
To add talkgroup	<ol style="list-style-type: none"> <li>a. Navigate to the required extended folder.</li> <li>b. Select a talkgroup slot and press <b>Menu/OK</b>.</li> <li>c. Select <b>Set TGs</b>.</li> <li>d. Search for the required talkgroup. Use <b>Menu/OK</b> to confirm selection.</li> </ol> <p> <b>NOTE:</b> The selected talkgroup is added to an empty slot. If the selected slot has an existing talkgroup, the newly selected talkgroup overwrites the old talkgroup.</p>
To delete a talkgroup	<ol style="list-style-type: none"> <li>a. Navigate to the required extended folder.</li> <li>b. Search for the required talkgroup. Press <b>Menu/OK</b>.</li> <li>c. Select <b>Delete</b>.</li> <li>d. Press <b>Menu/OK</b> at the confirmation notification to confirm deletion.</li> </ol>
To delete all talkgroups	<ol style="list-style-type: none"> <li>a. Navigate to the required extended folder.</li> <li>b. Select any talkgroup. Press <b>Menu/OK</b>.</li> <li>c. Select <b>Delete ALL</b>.</li> <li>d. Press <b>Menu/OK</b> at the confirmation notification to confirm deletion of all talkgroups.</li> </ol>

**Result:** Your radio displays a notification of the added or deleted talkgroup.

## 4.8

# Bluetooth

This menu activates the Bluetooth feature. See [Bluetooth on page 94](#) for details.

### 4.8.1

## Bluetooth Settings

Bluetooth Settings allows you to configure radio settings related to Bluetooth activity.

#### 4.8.1.1

### Configuring Bluetooth Settings

**Procedure:**

1. From the home screen, press the **Menu/OK** key.
2. Select **BT Settings**.
3. Select one of the following options:
  - **Bluetooth** – enables/disables Bluetooth.
  - **Discoverable** – enables/disables radio discoverable.

- **Add Device** – search for discoverable devices for pairing.
  - **Disconnect All** – disconnect all connected remote devices.
  - **Audio** – determines the audio connection mode for headsets. You can select one of the following options:
    - **Power Optimized** – the Bluetooth audio link is released when there is no active call. This option increases the battery life time, but causes a delay in the call setup time for group calls. This delay may result in lost audio on some headsets.
    - **GC Optimized** – the Bluetooth audio link is kept open all the time. This option ensures that audio during group calls is heard without any delay and the audio link is never lost, but shortens the battery life time.
-  **NOTE:** This setting does not affect the Motorola Solutions headset with PTT (NNTN8143\_ or NNTN8191\_) as it is always in the **GC Optimized** mode.
- **Indoor Loc.** – toggle on/off Bluetooth location mode.
  - **Sensor Alert** – toggle on/off sensor alert.

#### 4.8.2

## Enabling and Disabling Bluetooth

### Procedure:

1. From the home screen, press the **Menu/OK** key.
2. Select **BT Settings** → **Bluetooth**
3. Select **On** to enable, or **Off** to disable Bluetooth.

 **NOTE:** Bluetooth is enabled automatically when you access **Add Device** sub-menu (see [Add Bluetooth Devices on page 95](#)). You can also enable Bluetooth using the One Touch Button.

When Bluetooth is enabled, the Bluetooth icon appears in the status icon area on the display. However, the Bluetooth icon may not be visible at times, due to other icons with higher priority being displayed in the same icon slot.

 **NOTE:** Your service provider may configure the radio to automatically disable Bluetooth after entering the home mode. The home mode is a state in which all the following conditions are met: the radio is not in the Discoverable Mode, all active remote devices are disconnected (including file transfer), and scanning for remote devices is not performed.

#### 4.8.3

## Pairing Bluetooth Devices with Your Radio

Pairing is a process that creates a link between two Bluetooth-enabled devices. Once paired, devices remember each other and every subsequent connection between them is authenticated automatically.

**When and where to use:** To scan for available Bluetooth-enabled devices and to connect with them.

### Procedure:

1. From the home screen, press the **Menu/OK** key.
2. Select **BT Settings** → **Add Device**. Ensure that the device you want to connect with is in pairing mode.

The radio lists available devices that can be paired with your radio.

3. Highlight the required device and press **Menu/OK**.



**NOTE:** Press accessory **PTT** button to improve the connection between the accessory and radio.

#### 4.8.4

## Devices

This menu item lists all devices paired with your radio and allows you to perform the following operations:

- Connect a device.
- View and change device details.
- Disconnect a device.
- Delete a device.

#### 4.8.4.1

## Connecting or Disconnecting Devices

**Prerequisites:** Only pre-approved sensor devices can be used. The service provider is responsible for configuring the radio to work with specific devices. See [Add Bluetooth Devices on page 95](#).

### Procedure:

1. From the home screen, press the **Menu/OK** key.
2. Select **BT Devices**
3. Highlight the required device and press **Menu/OK**. Select **Connect/Disconnect**.



**NOTE:**

Depending on languages installed on the radio, some characters in names of devices might not be displayed properly.

Radio-initiated automatic reconnection with several remote Bluetooth devices at the same time cannot be guaranteed to be successful in 100%, due to the fundamental nature of Bluetooth. In case the reconnection fails after a power cycle (power off and power on of the radio), reconnect the device manually.

#### 4.8.4.2

## Managing Devices

### Procedure:

1. From the home screen, press the **Menu/OK** key.
2. Select **BT Devices**.
3. Highlight the required device and press the **Menu/OK** key.
  - **Connect/Disconnect** – connect or disconnect the device.
  - **Access** – defines how the radio behaves during a reconnection attempt after losing connection to this device:
    - **Automatic** – the radio connects with the device automatically.
    - **Ask** – the radio asks you for confirmation before connecting with the device.
    - **Manual** – the radio connects with the device manually.
    - **Never** – the radio never connects with the device.

- **Battery Level** – display the battery level received from the device.  
 **NOTE:** Only apply to low energy devices that supports battery service.
- **Delete** – deletes the device from the paired devices lists.

#### 4.8.5

## Disconnecting All Devices

**When and where to use:** To disconnect all remote devices connected to your radio.

**Procedure:**

1. From the home screen, press the **Menu/OK** key.
2. Select **BT Settings** → **Disconnect All**.

**Result:** All devices are disconnected.

 **NOTE:** To disconnect only one device, from the home screen, select **Menu/OK** → **BT Devices**, highlight the required device, and press **Menu/OK**. Select **Disconnect**.

#### 4.8.6

## Setting Indoor Location

 **NOTE:** Your service provider can enable this feature.

Indoor Location is used to track radio location while the radio is indoors. When Indoor Location is activated, your radio receives beacon information from various dedicated beacons within the range of the radio. The radio then sends the information within a Location Information Protocol message to the Switching and Management Infrastructure, and a mapping application decodes the information to calculate the location of the radio.

**Procedure:**

1. From the home screen, press the **Menu/OK** key.
2. Select **BT Settings** → **Indoor Loc**.
3. Select **On** or **Off** to activate or deactivate Indoor Location.

**Result:** Your radio is now able to detect Bluetooth location beacons when Indoor Location is activated.

 **NOTE:** The use of the Indoor Location feature may have a negligible impact on other Bluetooth functions on your radio.

#### 4.8.6.1

## Viewing Detected Beacons

**Prerequisites:** Turn on Indoor Location. If Indoor Location is turned off, the screen displays *Service Restricted*.

**Procedure:**

1. From the home screen, press the **Menu/OK** key.
2. Select **BT Settings** → **Indoor Loc**.
3. Select **Beacons Found**.

4. Select the preferred beacon.  
The screen displays details of the beacon.

#### 4.8.7

## Connecting Firearms Devices

**Prerequisites:** Only pre-approved firearms devices can be used. The service provider is responsible for configuring the radio to work with specific devices. See [Add Bluetooth Devices on page 95](#).

**When and where to use:** To select a firearm sensor device for Bluetooth connection.

### Procedure:

1. From the home screen, press the **Menu/OK** key.
2. Select **BT Settings** → **Firearms**.
3. Highlight your firearm sensor device and press **Menu/OK** to connect.



**NOTE:**

Activation code must be sent to the device by third-party application.

Radio-initiated automatic reconnection with several remote Bluetooth devices at the same time cannot be guaranteed to be successful in 100%, due to the fundamental nature of Bluetooth. In case the reconnection fails after a power cycle (power off and power on of the radio), reconnect the device manually.

The radio is now able to notify the dispatcher when the status of the firearm device changes. If configured, the location (using GNSS) of the radio is reported as well. Once a firearm sensor device is connected, it can be managed from the Devices menu.

4. To disconnect a firearm sensor device, go to the Devices menu and follow the normal device management procedure.

#### 4.9

## Man Down (Fall Alert)



**NOTE:** This is a Software Selling Feature.

Man Down (henceforth known as Fall Alert) alerts when no movement occurs for a set time or the radio stays at an angle of tilt below a defined value. The radio alerts you when:

- Its tilt exceeds a predefined angle value.
- No movement is detected in a predefined time interval.

In case any of the conditions are met, the radio alerts you with a Man Down (Fall Alert) pre-alert. If you do not disable the pre-alert condition, the radio switches to the Emergency Operation.

For easier localization of the radio, visual and audible indications are started until they are deactivated. If the Emergency Hot Microphone is on, the additional audio indication is not played.

To exit Man Down (Fall Alert), exit the Emergency Mode by pressing and holding the **Exit Soft** key, or press the **PTT** button.

#### 4.9.1

## Setting Man Down (Fall Alert)

### Procedure:

1. From the home screen, press the **Menu/OK** key.
2. Select **Man Down** (henceforth known as Fall Alert).
3. Select one of the following options:
  - **On** – Activates the feature.
  - **Off** – Deactivates the feature.

#### 4.10

## Scan

This menu item allows you to activate/deactivate scanning and view the active scan list. This feature is available only for the TMO Mode. Your radio joins any group call as long as this group is defined in the scan list and scan is turned on.

#### 4.10.1

## Enabling Talkgroup Scanning

**When and where to use:** If you want to monitor any TMO Group Call in the defined talkgroup list.

### Procedure:

1. From the home screen, press the **Menu/OK** key.
2. Select **Scanning**.
3. Select one of the following options:
  - **On** – to activate scanning.
  - **Off** – to deactivate scanning.

#### 4.10.2

## Activating Talkgroup Scanning

**Prerequisites:** Talkgroup scanning must be enabled.

**When and where to use:** If you want to monitor any TMO Group Call in the defined talkgroup list.

### Procedure:

1. From the home screen, press the **Menu/OK** key.
2. Select **Scanning** → **Select List**.
3. Select the required Scan List and press **Menu/OK**.
4. Select **Select** and press **Menu/OK**.

**Result:** Your radio is scanning on the predefined scan list.

#### 4.10.3

## Viewing Scan Lists

**When and where to use:** Viewing information on a selected talkgroup in the selected scan list.

**Procedure:**

1. From the home screen, press the **Menu/OK** key.
2. Select **Scanning** → **Select List** → *<Scan List>*.
3. Select one of the following options:
  - **View** → *<Talkgroup>* – Displays information on the selected talkgroup in the selected scan list.
  - **Capacity** – Displays the number of talkgroups in the selected scan list.

#### 4.10.4

## Renaming Scan List

**When and where to use:** Entering a new name for the selected Scan List.

**Procedure:**

1. From the home screen, press the **Menu/OK** key.
2. Select **Scanning** → **Select List** → *<Scan List>* → **Rename**.
3. Edit the name of the selected Scan List and long press **Menu/OK** to confirm.

**Result:** Selected Scan List is renamed accordingly.

#### 4.10.5

## Clearing Scan List

**When and where to use:** Deleting all talkgroups assigned to the selected Scan List.

**Procedure:**

1. From the home screen, press the **Menu/OK** key.
2. Select **Scanning** → **Select List** → *<Scan List>* → **Clear**.
3. Press **Menu/OK** to confirm.

**Result:** Your radio displays confirmation of the cleared Scan List.

#### 4.10.6

## Adding Group to Scan List

**When and where to use:** Adding a talkgroup to the Scan List.

**Procedure:**

1. From the home screen, press the **Menu/OK** key.
2. Select **Scanning** → **Select List** → *<Scan List>* → **Add Group**.  
Your radio displays talkgroup folders.
3. Select the required folder and press **Menu/OK** to view the talkgroups available.
4. Select the required talkgroup and press **Menu/OK** to select scan priority.

5. Select one of the following options:

- **Low**
- **Medium**
- **High**

6. Press **Menu/OK**.

**Result:** Selected talkgroup with the selected scanning priority is added to the Scan List.

#### 4.10.7

## Editing Talkgroup

**When and where to use:** Changing the priority of the required talkgroup or deleting it.

**Procedure:**

1. From the home screen, press the **Menu/OK** key.
2. Select **Scanning** → **Select List** → *<Scan List>* → **Edit**.
3. Select the required talkgroup and press **Menu/OK**.
4. Perform one of the following actions:
  - To delete the talkgroup from the scanning list, select **Delete** and press **Menu/OK**. Press **Menu/OK** to confirm deletion.
  - To change the scan priority, select **Priority** and press **Menu/OK**. Select one of the following option and press **Menu/OK** to change the priority:
    - **Low**
    - **Medium**
    - **High**

**Result:** Your radio display confirmation of the action you selected.

#### 4.11

## Security

Security menu stores all your security settings.

#### 4.11.1

### PIN Protect

This feature allows you to enable/disable PIN code authentication at the next power on. This code protects your radio against unauthorized use.



**NOTE:** Customers are strongly advised to change the default PIN code in order to protect devices from unauthorized access.



**NOTE:**

If the radio uses a BSI PIN code and you are unable to unlock the radio, you cannot take any action.



#### 4.11.1.1

### Protecting the Radio with a PIN Code

#### Procedure:

1. From the home screen, press the **Menu/OK** key.
2. Select **Security** → **PIN Protect**.
3. Select **On**.
4. Enter the PIN code.



#### NOTE:

To increase security, set your own PIN code. By default the PIN code are all zeros (depending on the length of the PIN code). For radios with general PIN authentication, the PIN length is a fixed 4-digit code. For radios with BSI PIN authentication, the PIN length is configurable by your service provider up to a maximum of 8-digit code.

**Postrequisites:** Each time you turn on the terminal, PIN code is required.

#### 4.11.1.2

### Changing PIN Codes



**NOTE:** This feature is only available when enabled by your service provider.

#### Procedure:

1. From the home screen, press the **Menu/OK** key.
2. Select **Security** → **Change Code**.
3. Radio prompts for the `Old Code`.



#### NOTE:

To increase security, set your own PIN code. By default the PIN code are all zeros (depending on the length of the PIN code). For radios with general PIN authentication, the PIN length is a fixed 4-digit code. For radios with BSI PIN authentication, the PIN length is configurable by your service provider up to a maximum of 8-digit code.

4. If the entered code matches the old code, radio prompts for the new code twice.

**Result:** Your radio displays `Code Accepted`.

#### 4.11.2

### Setting Keypad Lock

By default, the **Power** and **Emergency** buttons are always operative when the keypad is locked.

#### Procedure:

1. To lock, press **Menu/OK** and select **Security** → **Keylock Setup** → **Lock Keypad**.
2. To unlock, perform one of the following actions:
  - If the display is turned on and the buttons are active, press **Back** → **Up** → **Menu/OK**.
  - If the display is turned off, press the **Power** button to wake the display, press the **Menu/OK** button to activate the buttons, and press **Back** → **Up** → **Menu/OK**.



**NOTE:** If Auto Lock is turned on, the keypad automatically locks when the timer expires.

### 4.11.3

## Air Encryption



**NOTE:** This is a Software Selling Feature.

This menu item allows you only to view air encryption state.

Air Encryption is a feature that enables encryption of entire communication between the radio and infrastructure, which results in increased security of calls, messages, and data.

If configured by your service provider, the radio plays a sound and displays `Call & Data Not Encrypted` when encryption is on and you receive a clear call (unencrypted). This feature provides service confidentiality between you and the system.

#### 4.11.3.1

### Viewing Air Encryption State

#### Procedure:

1. From the home screen, press the **Menu/OK** key.
2. Select **Security** → **AirEncrypt**.

Your radio displays:

- `Air Encryption Is Off` – The Air Encryption is not activated.
- `Air Encryption Is On` – The Air Encryption is activated.

#### 4.11.3.2

### Deleting User Keys



**IMPORTANT:** The key deletion takes up to 30 seconds.

**Prerequisites:** Ensure that the user key deletion is enabled in the codeplug.

#### Procedure:

Press **OK** → **Power** → **Power** → **Down** → **Down** → **Power** → **Power** → **Up** → **Up**.

**Result:** Encryption and/or Authentication keys are deleted. The radio enters Temporary Disable state and the service provider must manually restore it.

#### 4.11.4

## K Validity

Key (K) is a secret key the infrastructure uses to authenticate the radio in the system. It is part of the authentication that provides service confidentiality between your radio and the system.

#### 4.11.4.1

### Verifying K Validity

#### Procedure:

1. From the home screen, press the **Menu/OK** key.

2. Select **Security** → **K Validity**.

Your radio displays:

- **K is Valid** – The infrastructure can authenticate your radio.
- **K is Invalid** – The infrastructure is unable to authenticate your radio. Please call your service provider to restore the key to your radio.

#### 4.11.5

## SCK (Air Interface Encryption Class 2)

Static Cipher Key (SCK) is a secret key used for the Air Interface Encryption Class 2. It may be used to encrypt calls and data in TMO and DMO.

The SCK air interface encryption provides service confidentiality between radios and infrastructure when in TMO, and between radios when in DMO. A radio is capable of being loaded with up to 32 SCKs. Specific keys are used for encrypting the air interface.

Any mismatch between radios and/or infrastructure impacts communication – only those using the same key as the transmitting party are able to decode and hear the communication.

#### 4.11.5.1

### TMO SCK

Your service provider can enable SCKs in TMO. The SCKs used in TMO are called TMSCKs.

#### 4.11.5.1.1

### Verifying TMSCK Validity

**When and where to use:** To ensure that the TMSCKs in the radio are valid and can be used for the air interface encryption.

**Procedure:**

1. From the home screen, press the **Menu/OK** key.
2. Select **Security** → **TMSCK Validity**.

The radio displays:

- **TMSCK is Valid** – The radio can work encrypted in TMO.
- **TMSCK is Invalid** – The radio cannot work encrypted in TMO. Please contact your service provider to restore SCKs to your radio.

#### 4.11.5.2

### DMO SCK

Your service provider can enable SCKs in DMO. The SCKs used in DMO are called DMSCKs.

#### 4.11.5.2.1

### Verifying DMSCK Validity

**When and where to use:** To ensure that the DMSCKs in the radio are valid and can be used for the air interface encryption.

**Procedure:**

1. From the home screen, press the **Menu/OK** key.
2. Select **Security** → **DMSCK Validity**.

The radio displays:

- **DMSCK is Valid** – The radio can work encrypted in DMO.
- **DMSCK is Invalid** – The radio cannot work encrypted in DMO. Please contact your service provider to restore SCKs to your radio.

#### 4.11.5.3

### Viewing the Status of DMO SCK

**Procedure:**

1. From the home screen, press the **Menu** key.
2. Select **Security** → **DMO SCK**.

**Result:** The screen displays the status of the DMO Static Cipher Key.

#### 4.12

### Setup

The Setup menu allows you to change the general configuration on your radio.

#### 4.12.1

### Vibrate

This sub-menu allows you to determine if your radio vibrates, or rings, or vibrates and then rings when receiving a call.



**NOTE:** The vibration when pressing the capacitive Touch User Interface, known as Haptic Feedback, is enabled by default and not controlled by this menu.

#### 4.12.1.1

### Setting Default Vibrate

**Procedure:**

1. From the home screen, press the **Menu/OK** key.
2. Select **Setup** → **Vibrate**.
3. Select one of the following options:
  - **Vibe then Ring**
  - **Vibe Only**
  - **Ring Only**

#### 4.12.2

## Location

 **NOTE:** This is a Software Selling Feature.

This sub-menu allows you to enable the GNSS.

See [GNSS Location Service on page 99](#).

#### 4.12.2.1

### Enabling or Disabling Location

#### Procedure:

1. From the home screen, press the **Menu/OK** key.
2. Select **Setup** → **Location**.
3. Select **On** or **Off**.

#### 4.12.3

## Language

This sub-menu allows you to change the language of the radio.

#### 4.12.3.1

### Setting Language

**Prerequisites:** The list of available languages is set by service provider.

#### Procedure:

1. From the home screen, press the **Menu/OK** key.
2. Select **Setup** → **Language**.
3. Select desired language.

#### 4.12.4

## Tones

This field allows you to activate or deactivate the tones set.

 **NOTE:** The radio has two tone packs: Classic Tones (default) and New Tones. Your service provider decides which tone pack is enabled.

#### 4.12.4.1

### All Tones

You can activate/deactivate all tones.

#### 4.12.4.1.1

### Setting All Tones

#### Procedure:

1. From the home screen, press the **Menu/OK** key.
2. Select **Setup** → **All Tones**.
3. Select one of the following options:
  - **On** – Activates all the tones.
  - **Off** – Deactivate all the tones.

#### 4.12.4.2

### D-PTT Tones

This menu item contains the settings for the Double PTT feature.

The Double PTT feature allows you to send a tone pattern (single, double, or triple) when the radio is in idle or the Group Call mode by pressing the **PTT** button twice.

After the D-PTT tone is played, you can press and hold the **PTT** button once again to get the permission to talk. Otherwise, if you press the **PTT** button while the D-PTT tone is played, it is ignored.

After the D-PTT tone is sent, keeping the **PTT** button pressed results in permission to talk.

The D-PTT tone is sent over the air but is not audible on the sending radio.

#### 4.12.4.2.1

### Setting D-PTT Tones

#### Procedure:

1. From the home screen, press the **Menu/OK** key.
2. Select **Setup** → **Tones** → **D-PTT Tones**.
3. Select one of the following options:
  - **D-PTT Mode** – Activates/deactivates D-PTT tone.
  - **Tone Style**– Indicates how many times the D-PTT tone is played.

#### 4.12.5

### Time and Date

This sub-menu controls the displayed time and date on the home screen.



**NOTE:** Infrastructure synchronizes the time and date. When not within the infrastructure signal range you can set the values manually.

#### 4.12.5.1

### Setting the Time Manually

**When and where to use:** If the time cannot update automatically through the infrastructure.

#### Procedure:

1. From the home screen, press the **Menu/OK** key.
2. Select **Setup** → **Time & Date** → **Set Time**.

3. Enter current time using Navigation keys.

To set the next value, press **Menu/OK**. To go back to the previous value, press **Back**.

#### 4.12.5.2

### Setting the Date Manually

**When and where to use:** If the date cannot update automatically through the infrastructure.

**Procedure:**

1. From the home screen, press the **Menu/OK** key.
2. Select **Setup** → **Time & Date** → **Set Date**.
3. Enter current date using Navigation keys.

To set the next value, press **Menu/OK**. To go back to the previous value, press **Back**.

#### 4.12.5.3

### Setting Time Offset

**Procedure:**

1. From the home screen, press the **Menu/OK** key.
2. Select **Setup** → **Time & Date** → **Set Offset**.
3. Enter time offset using Navigation keys.

To set the next value, press **Menu/OK**. To go back to the previous value, press **Back**.



**NOTE:** You can adjust the offset value, with 15 minute steps, up to 14 hours ahead or behind.

#### 4.12.5.4

### Setting Automatic Updates for the Time and Date

**Procedure:**

1. From the home screen, press the **Menu/OK** key.
2. Select **Setup** → **Time & Date** → **System Update**.
3. Select one of the following options:
  - **Off** – All the infrastructure information are ignored. The radio uses internal time and offset.
  - **Time Only** – Time displayed is calculated from the offset programmed by your service provider added or subtracted from the infrastructure time.
  - **Time & Offset** – Time and offset are updated after receiving from the infrastructure.

#### 4.12.6

### Accessory (Accry) Setup

You can connect accessories to the audio connector at the bottom of the radio.

If you connect an accessory, the radio detects the connection and selects the IMPRES accessory automatically.

The **Accry Setup** menu contains the supported accessories, represented by their Model Number as defined by the related Audio Device Descriptor (ADD). ADD is a set of parameters in the radio that defines the audio settings, such as gains and filters settings, for each accessory.



**NOTE:** To ensure proper connection of the audio accessory, fully insert the audio connector into the bottom connector of the radio. Ensure that the thumbscrews are fully fastened before powering on the radio. To resolve connection issues caused by partial insertion, remove and reinsert the audio connector.

#### 4.12.7

## Default Setting

This sub-menu item resets the radio back to default settings.

#### 4.12.7.1

### Selecting Default Setting

#### Procedure:

1. From the home screen, press the **Menu/OK** key.
2. Select **Setup** → **Def. Settings**  
Your radio display `Reset to def. settings?`. Press **Menu/OK** to confirm.

#### 4.13

## My Info

This sub-menu allows you to view your own private, phone, and radio info.

#### 4.13.1

### Viewing Personal Information

#### Procedure:

1. From the home screen, press the **Menu/OK** key.
2. Select **My Info**.
3. Select one of the following options:
  - **My Private Num** – displays your radio private number.
  - **My Phone Num** – displays your radio phone number.
  - **Radio Info** – displays radio information: manufacturer, product type, ISSI, TEI, and Serial Number.
  - **Battery Info** – displays battery charge in %.

#### 4.13.2

### Viewing Talkgroup Subaddresses

#### Procedure:

1. From the home screen, press the **Menu** key.
2. Select **My Info** → **Talkgroup Info** → **Talkgroup List** → **View Talkgroup sub-addresses**.



#### 4.14

## Recent Calls

You can view the history of all calls:

- **Dialed** – Calls you initiated.
- **Received** – Calls you answered.
- **Missed** – Calls you received but not answered or rejected.

Each list of calls may contain up to 50 numbers, the most recent call being at the top of the list. If the number of a recent call is stored in the contact list, the name associated with the number appears in the recent calls list. A number dialed more than once, appears only once in the list.



**NOTE:** Calls missed in TXI mode are stored and can be viewed.

#### 4.14.1

## Viewing Recent Calls

### Procedure:

1. From the home screen, press the **Menu/OK** key.
2. Select **Recent Calls**.
3. Select one of the following options:
  - **Dialed**
  - **Received**
  - **Missed**
4. Select a required call from the list.
5. press the **Menu/OK** key.  
Your radio display a detailed view of the call event.

#### 4.14.2

## Calling from Recent Calls

### Procedure:

1. From the home screen, press the **Menu/OK** key.
2. Select **Recent Calls**.
3. Select one of the following options:
  - **Dialed** (from the home screen press **Send** key to access **Dialed Calls** list)
  - **Received**
  - **Missed**
4. Highlight the required call and press **Menu/OK**.
5. Highlight **Call** and press **PTT** button for private calls or press **Send** key for phone call.



**NOTE:** Phone calls are only available in TMO Mode.

### 4.14.3

## Deleting Recent Calls

### Procedure:

1. From the home screen, press the **Menu/OK** key.
2. Select **Recent Calls**.
3. Select one of the following options:
  - **Dialed**
  - **Received**
  - **Missed**
4. Highlight the required call and press **Menu/OK**.
5. Select **Delete**.



**NOTE:** To erase all the calls, select **Delete All**.

### 4.15

## Networks

This menu item allows you to switch between the radio operation modes.

### 4.15.1

## Selecting Network Operation Mode

### Procedure:

1. From the home screen, press the **Menu/OK** key.
2. Select **Networks**.
3. Select one of the following options:
  - **Network Sel** – Selects the network to which the radio is allowed to register.
  - **Trunked Mode** – Switches to the mode using infrastructure.
  - **Direct Mode** – Switches to the mode without using infrastructure.
  - **DMO Config** – Only available in Direct Mode. See [Selecting DMO Communications Options on page 47](#).
  - **TXI Mode** – Select **Activate** to stop sending any radio transmission.



**NOTE:** If the radio is in **TXI Mode**, it is not possible to switch from **Direct Mode** to **Trunked Mode**.

### 4.16

## Crypto Menu

This sub-menu allows you to manage SIM card based End-to-End Encryption.

The End-to-End Encryption is used for:

- Encryption of messages transmission in the TMO Mode.
- Encryption of position data (GPS) transmission in the TMO and DMO Modes.

- Management of encryption keys in the TMO Mode.

#### 4.16.1

## Enabling or Disabling SIM Card End-to-End Encryption

### Prerequisites:

Ensure that:

- The SIM card is inserted in the radio.
- The radio is not in an active call.
- You cannot press the **PTT** button.

### Procedure:

To enable or disable the SIM card End-to-End Encryption, use one of the following options:

Option	Actions
Operating the configured One-Touch Button	Press the One-Touch button.
Operating from the menu	<ol style="list-style-type: none"> <li>a. Press <b>Menu</b> → <b>Crypto Menu</b> → <b>Crypto Function</b>.</li> <li>b. Select <b>Encryption On</b> to enable or <b>Encryption Off</b> to disable encryption.</li> </ol>

Your radio displays prompts indicating your current encryption state: an appropriate status icon and the `Encryption On` or `Encryption Off` message.

#### 4.16.2

## Enabling or Disabling CRYPTR Micro or Micro HSM End-to-End Encryption

### Prerequisites:



**NOTE:** Your radio is either MicroSD card-enabled or SIM card-enabled. This feature is only available for MicroSD card-enabled radio.

- Ensure that the CRYPTR Micro or Micro HSM card is inserted in the radio.
- The radio is not in an active call.
- You cannot press the **PTT** button.

See [CRYPTR Micro or Micro HSM End-to-End Encryption on page 99](#).

### Procedure:

1. From the home screen, press **Menu** → **Crypto Menu** → **Crypto Function**.
2. Select **Encryption On** to enable or **Encryption Off** to disable encryption.

**Result:** Your radio displays a status icon and the `Encryption On` or `Encryption Off` message to indicate your current encryption state.

### 4.16.3

## Setting Clear Call Alarm

**When and where to use:** The **Clear Call Alarm** menu is used to configure an alarm tone to notify on any clear transmission.

**Procedure:**

1. From the home screen, press the **Menu/OK** key.
2. Select **Crypto Menu** → **Clear Call Alarm**.
3. Select **Simplex Calls** or **Duplex Calls**.
4. Select one of the following options:
  - To disable the alarm, select **Off**.
  - To enable the alarm to ring once at the beginning of a clear call, select **Single**.
  - To enable the alarm to ring periodically throughout a clear call, select **Continuous**.

### 4.16.4

## Updating Encryption Keys

**When and where to use:** The Updating Encryption Keys menu is used to update old or incorrect encryption keys.

**Procedure:**

1. From the home screen, press the **Menu/OK** key.
2. Select **Crypto Menu** → **Upd Encr Keys**.
3. Select **Upd Group Key** to start the update.



**NOTE:** You can update the encryption keys if the End-to-End Encryption is enabled. The keys cannot be updated when the radio is in a call or in Direct Mode Operation (DMO).

### 4.16.5

## Viewing OPTA

**When and where to use:** The **Show OPTA** menu is used to view Operational Tactical Address (OPTA) that provides supplementary information about the organization and operational role of a radio.

**Procedure:**

1. From the home screen, press the **Menu/OK** key.
2. Select **Crypto Menu** → **Show OPTA**.

### 4.16.6

## Starting Crypto Registration

**Prerequisites:** Ensure that your radio is not in an active call or in Direct Mode Operation (DMO).

**Procedure:**

1. From the home screen, press the **Menu/OK** key.
2. Select **Crypto Menu** → **Crypto Registr**.
3. Select **Start Registr** to start the registration.

#### 4.16.7

## Configuring Audio Settings

The **Audio Settings** menu is used to change the audio output for a group call when the call is encrypted but the End-to-End Encryption is disabled.

### Procedure:

1. From the home screen, press the **Menu/OK** key.
2. Select **Crypto Menu** → **Audio Settings**.
3. Select **Encr On** to enable or **Encr Off** to mute the encrypted audio for clear mode.

#### 4.16.8

## Setting DMO Encryption Mode

### Procedure:

1. From the home screen, press the **Menu/OK** key.
2. Select **Crypto Menu** → **DMO Encr Mode**.
3. Enable the required mode by selecting one of the following options:
  - For crypto mode bit 1, select **DMO 1**.
  - For crypto mode bit 2, select **DMO 2**.

## Chapter 5

# Features

### 5.1

## Ambience Listening (AL) Call

Ambience Listening Call allows a dispatcher to make a special call that allows listening to the conversations and background noises within the range of the microphone of a particular radio.

The call is set up without any indication to the affected radio, and any lower priority ongoing voice call may be preempted.

After accepting the call, the radio transmits in a simplex call without any action from or indication to the user. The Ambience Listening Call automatically ends when you initiate any voice call, switch to Emergency or TXI Mode, or send Emergency Alarm.

### 5.2

## Bluetooth

Bluetooth is a wireless technology used to create personal networks operating in the 2.4 GHz unlicensed band with a range of up to 10 m.

The radio supports Bluetooth 2.1 + EDR, 4.1, and Bluetooth Smart (BTLE). The Secure Simple Pairing feature ensures a high level of security while pairing devices, thus protecting you against recording and passive eavesdropping.

One radio can be connected with up to seven devices at the same time.

The usable range may be reduced when you connect the radio with devices that support more limited ranges or if physical obstacles such as walls appear between devices. Five separate Bluetooth features available:

- Bluetooth Audio – includes Bluetooth Audio and Fast Push-to-Talk (PTT)
- Bluetooth Connectivity – includes Bluetooth Dial Up Networking (DUN) and Bluetooth Serial Port Profile (SPP)
- Bluetooth Radio Control – includes Bluetooth Radio Control using AT commands and Bluetooth Generic Attribute Profiles (GATT) Sensors
- Bluetooth Smart Proximity Pairing
- Bluetooth Smart Ready includes:
  - Bluetooth Low Energy Indoor Location,
  - Bluetooth Low Energy Heart Rate Profile
  - Bluetooth Generic Attribute Profiles (GATT) Sensors



**NOTE:** Bluetooth Audio, Bluetooth Connectivity, Bluetooth Radio Control, Bluetooth Smart Proximity Pairing, and Bluetooth Smart Ready are Software Selling Features.

You can use Bluetooth to:

- Connect the radio with wireless accessories, for example a headset, which gives you a greater freedom of movement and increases your work comfort. Also, wireless accessories allow performing the same activities in several ways. For example, you can change the volume level either in the headset or on the radio.
- Allow your radio to detect BTLE iBeacons.

- Allow radio collaboration with various Bluetooth sensors or data capture devices, for example biometric sensors, bar code scanners, or firearm devices.
- Allow radio collaboration with a body worn camera for photo and video capturing purposes.
- Increase connectivity with secure packet data services between the radio and a data device or a smartphone running appropriate applications.
- Enable radio control through a data device.

### 5.2.1

## Bluetooth Interactions

The Bluetooth feature interacts differently with other features and situations of the radio.

The following features and situations limit the use of Bluetooth:

### Covert Solution

The radio cannot enter Discoverable Mode while in the Covert Solution as Covert Solution has a higher priority.

### Transmit Inhibit Mode (TXI)

Bluetooth does not work in the Transmit Inhibit Mode. When the radio enters the TXI while Bluetooth is enabled, all remote devices are disconnected and Bluetooth is disabled. After leaving the TXI, Bluetooth is enabled again (if it was previously turned on).

### Wired Audio Accessories

Wired audio accessories have a higher priority than Bluetooth audio accessories. If both types of devices are connected to the radio, it disconnects the Bluetooth audio device. When a wired audio device is already connected to the radio, scanning for Bluetooth audio devices is disabled.

### 5.2.2

## Discoverable Mode

When the radio is in the Discoverable Mode, it is visible to other Bluetooth-enabled devices.

Also, it accepts connection requests from other devices attempting;

- to establish a DUN connection,
- or to start a remote control or AT Command session.

If enabled, the following item appears in the radio menu: **Discoverable** . The radio remains discoverable for the amount of time configured.

### 5.2.3

## Add Bluetooth Devices

Audio devices, such as headsets, body worn camera, or PTT pods are added (and connected) by selecting **Add Device** from the BT Settings menu.

Sensor devices, such as barcode scanners or firearms devices, and devices used for radio control must be added to the radio codeplug by the service provider before they can be used. Once the radio is configured to use specific sensor devices, they can then be added in the same manner as audio devices, for example; by selecting **Add Device** from the BT Settings menu.

See [Devices on page 75](#).

#### 5.2.4

## Bluetooth Smart Proximity Pairing

With the use of Proximity Pairing, you can instantly connect your radio with Bluetooth Low Energy (BTLE) devices.

BTLE devices are various types of sensors the radio can be paired with using Bluetooth, for example gas or heart rate sensors.

To pair the radio with a sensor, move the radio close to a sensor and press and hold the One-Touch Button. A tone indicates successful pairing and connection. After the connection, the radio collects information from the sensor.

#### 5.2.5

## Bluetooth Sensor Data

Your service provider can configure the details of the sensor information the radio displays.

Depending on the type of sensor connected to the radio and the setup configured by your service provider, various types of information are displayed. The following sections contain information on the most significant, pre-determined data the radio displays.

### Sensor Battery Information

The radio displays the percentage of the remaining battery power of the connected sensors.

### Heart Rate Sensor

If a heart rate sensor with the Energy Expended feature is paired and connected to the radio, two values are displayed:

- Heart Rate in bpm
- Energy Expended in kJ

### Sensor Alarm

A radio paired with appropriate sensors increases the security of the radio user by making the user more aware of their surroundings. If the collected values exceed limits set by your service provider, the radio plays an alarm tone, light the LED, and display a warning message. The alarm concerns, for example, low battery, high toxicity, or low/high heart rate.

The alarm is active for a pre-defined time or until you discard it.

### 5.3

## Call-Out



**NOTE:** This is a Software Selling Feature.

For those who use DMO mode, you are recommended to apply DMO SCK for data confidentiality.

This feature allows you to receive Call-Out alerts. On receiving the Call-Out messages, the radio interrupts current services and attends to the Call-Out alert without any further delay. After the Call-Out is cleared by the dispatcher, the radio exits Call-Out mode and reverts to normal mode.

Your radio plays a Call-Out tone according to the configured indication profile. The indication profile is configured based on the severity level of a matching Group Short Subscriber Identity (GSSI) and Sub-Address Group Call-Out.

During Call-Out mode, you are only able to receive Emergency calls. However, if your service provider configures Emergency Calls to be ignored during Call-Out mode, the radio rejects them with no notification.

If your service provider temporarily blocked the use of PTT in the Call-Out, pressing **PTT** in the Call-Out mode is considered an invalid key press until the timer expires.



The time-stamp on the Call-Out alert indicates the time and date when the Call-Out is received.

To read an entire Call-Out message, scroll down the screen by pressing the **Down** Navigation key. The length of the message is indicated by the vertical bar on the left of the screen.



**NOTE:** Message protection functionality is enabled in the Inbox and Call Out Inbox. Users can only delete unprotected messages.

### 5.3.1

## Types of Call-Out Alerts

There are five types of the Call-Out alerts:

### Normal Call-Out

An alert message that is sent by a dispatcher either to a single radio or to a group of radios. There are two types of Normal Call-Out:

#### With user receipt

The radio gets to the Accepted phase when you:

- select **Accept**, **Reject**, or **Standby**.
- the acknowledgment timer runs out.

#### Without user receipt

The radio gets to the Accepted phase when you:

- press **Menu/OK**.
- the acknowledgment timer runs out.

The Normal Call-Out mode is ended when the validity timer runs out.

### Storm Plan

An alert message that is sent by a dispatcher to a group of radios. To raise its reliability, it is sent several times. You are not able to respond to the Call-Out alert and any key press takes you to the information phase.

### Simple Call-Out

An alert with the functionality similar to full Call-Out but without the information phase. There are two types of Simple Call-Out:

#### With user receipt

The Call-Out mode is ended when the acknowledgment timer runs out, or when you select **Accept**, **Reject**, **Standby**, or reply with a text message.

#### Without user receipt

The Call-Out mode is ended when the acknowledgment timer runs out, or when you press **Menu/OK** to enter **CO Menu** and select **Exit**.

### Fallback Mode

An alert message that is limited only to voice communication. To initiate this type of Call-Out, press a One-Touch key predefined by your service provider. It can be cleared manually.



**NOTE:** Fallback is only possible when the radio is in Local Site Trunking.

### Test Call-Out

A special Call-Out alert sent by the dispatcher to test this feature. On receiving the Test Call-Out, the radio plays a tone and displays **Test Call-Out**. To respond and clear the alert, enter Call-Out menu and select **Test OK** or **Send Message**.

### 5.3.2

## Call-Out Modes Interaction

Call-Out feature operation is different in other modes:

### **TXI Mode**

You can receive Call-Out messages. The Call-Out alert message is displayed on the screen. You have the option to exit TXI Mode or exit the Call-Out prompt.

- Exit TXI - Your radio exits TXI mode and prompts you to accept or reject the Call-Out message.
- Exit Call-Out - Your radio exits the Call-Out message and returns to TXI mode.

### **TMO**

Call-Out is supported.

### **DMO**

Call-Out is supported.

### **Emergency Mode**

All Call-out alerts are ignored.

### 5.3.3

## Call-Out Service Phases

In the Call-Out mode there are following phases:

### **Alerting Phase**

Alerting users by using the LED pattern, vibration pattern, alert tone and volume level configured for the first matching sub address that contain the indication profile setting.

The radio receives a Call-Out message. An alarm tone indicates the message. When the text is displayed, you have the following options:

- **Accept**
- **Standby**
- **Reject**
- **Messages**



**NOTE:** If your service provider allowed it, you can stop the alert tone by pressing any key.

### **Information Phase**

You are still in the Call-Out mode and you can receive more detailed information about the incident that occurred through subsequent text or a voice message. You can query for more information using voice group call or Call-Out text function which enables you to send a text message.

Depending on the settings configured by your service provider, you are able to respond to a Call-Out by:

### **Dependent on text control**

Free text or Call-Out templates.

### **Free text**

Type a response.

### **Pre-coded message**

Select from a list of predefined replies.

## 5.4

# Collaborative Messaging

This feature allows external device to send/receive message when the radio application is enabled. The external device can be connected to the radio using either Bluetooth connection or wired cable connection.

It includes the following functions:

- Inbox/Outbox synchronization.
- Notification on message status, or user action synchronization between the external device and the radio.



**NOTE:** This feature does not support Call Out/RMS/Home Display.

## 5.5

# CRYPTR Micro or Micro HSM End-to-End Encryption

The table presents interactions occurring between radios with and without the CRYPTR Micro or Micro HSM Encryption Unit. CRYPTR Micro or Micro HSM provides End-to-End Encryption.

**Table 19: Radio Interactions**

Transmission Type	Transmitting Radio	Receiving Radio	Result
Private Call	CRYPTR Micro or Micro HSM	No CRYPTR Micro or Micro HSM	Call is not visible for the receiving radio. The transmitting radio displays Called Party Clear Only message.
Private Call	No CRYPTR Micro or Micro HSM	CRYPTR Micro or Micro HSM	Warning: clear call message appears and the call is received.
Group Call	CRYPTR Micro or Micro HSM	No CRYPTR Micro or Micro HSM	Call is not visible for the receiving radio.
Group Call	No CRYPTR Micro or Micro HSM	CRYPTR Micro or Micro HSM	Warning: clear call message appears and the call is received.



**NOTE:** To call a non-CRYPTR Micro/Micro HSM radio, turn off the CRYPTR Micro/Micro HSM End-to-End Encryption.

## 5.6

# GNSS Location Service



**NOTE:** This is a Software Selling Feature.

The Global Navigation Satellite System (GNSS) Location Service feature uses information from GNSS satellites orbiting the Earth to determine the approximate geographical location of your radio.

The GNSS Location Service availability, accuracy, and the position calculation time vary depending on the environment in which you use the radio. The GNSS Location Service can assist your dispatcher or colleagues in many ways. For example, deploying of resources more efficiently or locating your radio when you trigger your emergency service.

The radio can send the location information over-the-air to your dispatcher to display it in the control center. Check your radio configuration details with your service provider.

The radio supports the following system combinations:

- GPS
- GLONASS
- GPS + GLONASS



**IMPORTANT:**

Where the signals from satellites are not available, the GNSS Location Service does not work. This usually happens when your radio cannot establish a view of a wide area of open sky. An example would be when the GNSS antenna is covered or facing the ground. Such situations include being:

- In underground locations
- Inside buildings, trains, or other covered vehicles
- Under any other metal or concrete roof or structure
- Near a powerful radio or television tower
- In extreme temperature outside the operating limits of your radio

Even if your location information can be calculated in such situations, it may take longer to do so. Therefore, in any emergency situation, always report your location to your dispatcher. Where adequate signals from multiple satellites are available, your GNSS Location Service feature provides a location, most probably near to your actual location.

The radio can be triggered to send Location Reports in various circumstances, for example:

- Upon a request
- Entering Emergency Mode
- At specified time intervals
- At specified distance intervals



**NOTE:** LIP Triggers can be configured for TMO only, DMO only, or both modes at the same time.

The Location Reports can be sent both in Trunked Mode Operation (TMO) and Direct Mode Operation (DMO) by using:

- Short Data Service (SDS) messages
- Packet Data (in TMO mode only, with Packet Data enabled on the network by the service provider)

The radio can be configured to give audio-visual notifications upon sending the Location Reports.

### 5.6.1

## Enhance Performance

Sometimes the GNSS feature is unable to complete a location calculation successfully.

To maximize the ability of your radio to determine a location fix please note the following guidelines:

- Stay in the open – The GNSS feature works best where there is nothing between your radio and a large amount of open sky. If possible, go outside, away from tall buildings and foliage. While the performance in a building is improved by moving closer to windows, glass with certain sun shielding films may block satellite signals.
- Position your radio to enhance reception – Signals from GNSS satellites are transmitted to your GNSS antenna, which is in your radio antenna. Hold your radio away from your body, giving the antenna clear access to satellite signals. Do not cover the antenna area with your fingers or anything else.
- Stand still – If possible, stand still until your radio is finished determining your location. Moving your radio at a walking pace while your radio is calculating your approximate location may substantially decrease GNSS performance.

This feature works best where there is nothing between your radio and a large amount of open sky. To maximize the ability of your radio to determine a location fix, avoid closed space, tall buildings, and foliage. If possible, do not use this feature in underground parking lots, tunnels, under bridges, and close to high buildings.

### 5.6.2

## Location Report Backlog

Your radio can record location track when it is out of service, when in DMO, or when in TXI mode.

The location reports generated during this time are stored, and all location report backlog recordings are uploaded once your radio is back in service. Your radio can save up to a maximum of 180 location reports. The location report backlog function differently when in different mode:

#### **Location Backlog Recording in Trunked Mode Operation (TMO)**

Your radio starts recording location reports when radio is out of service in TMO Mode.

Your radio resumes the latest location reporting when TMO coverage is regained.

#### **Location Backlog Recording in Direct Mode Operation (DMO)**

Your radio starts recording location reports in DMO Mode.

Your radio resumes the latest location reporting when it switches back to TMO mode.



**NOTE:** This feature is only available when enabled by your service provider.

#### **Location Backlog Recording in Transmit Inhibit Mode (TXI)**

When your radio is in TXI mode, location reports are generated and recorded but not sent out.

Once your radio exits TXI mode and is within TMO coverage, the location reports are uploaded to the server.

### 5.6.3

## GNSS Accuracy

The GNSS Location Service accuracy depends on the GNSS coverage and the selected accuracy mode.

In good GNSS coverage (at least -137 dBm or in open sky), the location accuracy presents as follows:

- In high accuracy mode, the accuracy is:
  - 5 m for 50% of location reports.
  - 10 m for 95% of location reports.
- In power optimized or normal mode, the accuracy is:
  - 20 m for 50% of location reports.

- 50 m for 95% of location reports.



**NOTE:**

The presented values depend on variety of factors, for example the view on the sky. To optimize the GNSS performance the radio should have the clearest possible view of the open sky.

## 5.7

# Individual Call

Individual call is a point-to-point call between two TETRA radios.

The available individual calls are:

- Private Call
- Phone Call
- Private Automatic Branch Exchange (PABX) Call

### 5.7.1

## Private Call

Private call, also called point-to-point call, enables communication between two individuals. No other radio can hear the conversation.

This call type can be carried out in two ways:

### Duplex Call

This call type is only allowed in Trunked Mode Operation (TMO). During this call, both parties can speak at the same time.

### Simplex Call

Available in TMO or Direct Mode Operation (DMO). Only one party can speak at a time.

If configured, your radio can block outgoing private calls. The following are private calls that needs to be blocked in TMO:

- Half Duplex
- Full Duplex
- PSTN (Telephony)
- PABX

The following are private calls that needs to be blocked in DMO:

- Calls between Motorola Solutions radios
- Calls using Repeater
- Calls using Gateway

### 5.7.2

## Phone and PABX Calls

Phone Calls allow you to call a landline telephone number or a cellular mobile phone number. Private Automatic Branch Exchange (PABX) Calls allow you to call local (office) extension numbers.



**NOTE:** This feature is available only in Trunked Mode Operation (TMO).

The Phone/PABX Speed Dial feature allows you to dial a shortened number of up to three digits instead of the full number. The Phone/PABX **Speed #** number is assigned when the dialed number is added in the contact list.

If configured, your radio can block outgoing private calls. The following are private calls that needs to be blocked in TMO:

- Half Duplex
- Full Duplex
- PSTN (Telephony)
- PABX

The following are private calls that needs to be blocked in DMO:

- Calls between Motorola Solutions radios
- Calls using Repeater
- Calls using Gateway

### 5.7.3

## Receiving Individual Calls

#### Procedure:

1. Use one of the following methods to answer a private, phone, or Private Automatic Branch Exchange (PABX) call.
  - Press the **PTT** button.
  - Press the **Menu/OK** key.
2. To end the call, press the **Back** key.

### 5.8

## SIM Card End-to-End Encryption

The following table presents interactions occurring between radios with and without SIM cards. SIM cards provide End-to-End Encryption.



**NOTE:** SIM card End-to-End Encryption supports the Federal Office for Information Security of Germany (BSI) feature only.

**Table 20: Interactions between Radios with and without SIM Cards**

Transmission Type	Transmitting Radio	Receiving Radio	Result
Private Call	SIM card	No SIM card	The call is not visible for the receiving radio. The transmitting radio displays <code>Called Party Clear Only</code> .
Private Call	No SIM card	SIM card	The <code>Warning: clear call</code> notification appears and the call is received.
Group Call	SIM card	No SIM card	The call is not visible for the receiving radio.

Transmission Type	Transmitting Radio	Receiving Radio	Result
Group Call	No SIM card	SIM card	The warning: clear call notification appears and the call is received.



**NOTE:**

- To send a message or call a non-SIM card radio, turn off the SIM card End-to-End Encryption.

## 5.9

# Terminal Permanent Disable



**NOTE:** This is a Software Selling Feature.

Your radio is provided with a feature that allows your service provider to disable it permanently in case it is stolen or lost. When your radio is disabled permanently, it becomes inoperable.

After a Permanent Disable, your service provider cannot enable your radio. It is recommended to Permanent Disable your radio only when you do not expect to recover it. If it is recovered then a Permanent Disable radio can be reactivated by returning it to Motorola Solutions.

## 5.10

# Temporary Disable or Enable

Your radio is provided with a feature that allows your service provider to disable it temporarily in case it is stolen. When your radio is disabled or is powered up in disabled state, it looks and acts like it is turned off.

If your radio is found, your service provider can enable it again over the air. After your radio is enabled, you may resume normal operation.



## Appendix A

# LED Indications

 **NOTE:** LED Coverage Indicator and LED Power Indicator are differentiated on the radio. See [ST7500 Controls and Indicators on page 26](#) for the positions of the two LEDs.

**Table 21: LED Status Indications**

Indication	Status
Solid green	<ul style="list-style-type: none"> <li>• In use.</li> <li>• Repeating call.</li> </ul>
Blinking green	<ul style="list-style-type: none"> <li>• In service or idle.</li> <li>• Switching modes from TMO to DMO.</li> </ul>
Solid red	<ul style="list-style-type: none"> <li>• Out of service.</li> </ul>
Blinking red	<ul style="list-style-type: none"> <li>• Connecting to the network.</li> <li>• Switching modes from DMO to TMO.</li> </ul>
Solid orange	<ul style="list-style-type: none"> <li>• Radio is powering up.</li> <li>• Transmit inhibit in service.</li> <li>• Channel busy in DMO.</li> <li>• Radio interference in DMO.</li> <li>• Incoming Short Data Service (SDS) that is unread.</li> </ul>
Blinking orange	Incoming call.
No indication	<ul style="list-style-type: none"> <li>• Radio powered down.</li> <li>• Radio in Covert Solution.</li> </ul>

**Table 22: Battery Charging LED Indications**

Indication	Status
Solid green	Battery fully charged.
Blinking green	Battery charged at 90%.
Solid red	Rapid or trickle charge.
Blinking red	Faulty or invalid battery.

---

Indication	Status
Blinking orange	Battery is waiting to charge.

---



**NOTE:**

When you charge your radio in a multi-unit charger, the LED Power Indicator of the radio indicates the charge status of the battery.

If you insert a radio with a deeply discharged battery into the multi-unit charger, the LED on the radio shows blinking red, indicating a charging error. Resolve this error by reinserting the radio.

## Appendix B

# Troubleshooting

Your radio displays the following messages:

**Table 23: Displayed Messages**

Message	Message Description
Attachment Failed	Your radio could not perform talkgroup attachment. It keeps on trying. If it does not succeed, try another talkgroup.
Authenticate Failure	Your radio could not register on an authenticated system (for example, the Authentication Key is incorrect, or authentication is disabled).
Call Barred	The call is barred due to Barred Incoming Call or Barred Outgoing Call Profile.
Call Cancelled	You have canceled the call.
Call Ended	<ul style="list-style-type: none"> <li>Faulty channel. Please try later.</li> <li>You have ended the call.</li> </ul>
Call Forwarding	The radio you are trying to call is not available and the call is being forwarded to another radio.
Call Modified	The call you are participating in has been modified.
Call Preempted	Channel being used for priority.
Decryption Failed:	An error occurred while decrypting a message.
Emergency In Use Wait For Mic	The Hot Microphone feature is active, but the channel transmit grant has been given to another Emergency call on the same talkgroup. Your radio microphone is not active during this time, but it automatically tries to regain talk permit after a predetermined time.
Emgcy Mic Ended	The Hot Microphone timer automatically expired, or you pressed the <b>PTT</b> button to cancel the Hot Microphone feature.
Emergency Mic On	The Hot Microphone feature is active, and your radio is automatically transmitting hands free emergency audio.
Faulty Unit Error	Self-test failed. An operational fault has been detected with your radio. Record the error number. Turn your radio off and contact service.
Gateway available	Your radio has connected to a gateway.
Gateway not available	Your radio cannot connect to a gateway, or connection has been lost.
Individual Calls Only	You can make only individual (private) calls.
Invalid ID	The entered number is not valid.

Message	Message Description
Limited Service	Emergency Calls, Emergency Alarms, and mobility operations (for example, group attachment) are allowed. All other incoming and outgoing call and data services are blocked.
List Empty	There are no programmed entries in the scrolling list. Type the entry.
List Not Attached	All talkgroups in the scan list are not attached.
List Partially Attached	The scan list is active, but not all talkgroups are attached to it.
My Groups Is Empty	You cannot view/delete groups when the <b>My Groups</b> folder is empty.
Network Trouble	Network problems. Please try again later.
No Service	Your radio is outside coverage. Return to coverage.
No Answer	The called party does not answer.
No Entries	This message is displayed when accessing an empty list.
No Group	<ul style="list-style-type: none"> <li>● Attachment failed. Your radio detached from current talkgroup. Please wait until it attaches again to the current talkgroup.</li> <li>● Displayed when you are out of the normal coverage area of your selected talkgroup. Please select a new talkgroup that is valid for your working location.</li> <li>● Indicates a favorite group was removed from the <b>My Groups</b> folder.</li> </ul>
No List	The network list is empty.
No Selected Scan List	You selected an empty network list.
No Service	Your radio is out of coverage.
Not allowed in repeater mode	The service or feature is not available in the Repeater Mode..
Not Allowed To Initiate Call	You are not allowed to dial a number which is not in the address book.
Not Allowed To Transmit	Release the <b>PTT</b> button and try again later. You are not allowed to send a text message or a status message to a number which is not in the address book.
Overheating, Please Turn Radio Off	Your radio turns off. Keep it turned off for 5 minutes.
Party Busy	Called radio is busy.
Party Not Available	Called radio is out-of-range or turned off. Please try again later.
Please Try Again	You could not call.
Please Wait Connecting	A message during startup.
Radio Disabled	Check with your service provider.
Registration Failure	Your radio could not register within the system. Please try again later.
Repeater available	Your radio has connected to a repeater.

<b>Message</b>	<b>Message Description</b>
Repeater not available	Your radio cannot connect to a repeater, or connection has been lost.
Service Denied	Invalid number. Call your service provider.
Service Not Available	This service is not available on the current network.
Service Restricted	This service or feature is restricted by your service provider, it has not been purchased, or it is not available.
Single TalkGroup Only	There is only one programmed entry in the scrolling list.
Try Again Later	The requested service is temporarily unavailable.
Unit is OK Warn:	Self-test error. A minor fault has been detected. Your radio is still fully operative. If this error recur, note the error code and contact service.
Unit Not Attached	Your radio could not attach to the system. The talkgroup may not be defined in the system. Please try another group.

## Appendix C

# Maintenance



### TIP:

- Insert a fully charged battery before using your radio for the first time.
- Battery charging must occur only in non-hazardous areas.

### C.1

## Extending Battery Life

A battery is an expendable part and may need replacing during the life of the radio. To ensure maximum service life of your radio, always replace the battery with a genuine Motorola Solutions replacement.

### C.2

## Battery Charging Temperature

If, during charging, the temperature is out of range, the battery might not be fully charged since the charging is temporarily stopped until the temperature becomes suitable. The temperature range of battery operation is from 0 °C to +45 °C in charger mode.

### C.3

## Additional Battery Warnings/Cautions

- To prevent injury, do not allow metal objects to touch the battery contacts.
- Do not disassemble.
- Do not throw in fire.
- Do not dispose of battery in household waste.

### C.4

## Looking after Your Radio



**IMPORTANT:** To avoid compromising the ingress protection of IP67, do not remove the seal label at the side of the radio. See [ST7500 Controls and Indicators on page 26](#).



### NOTE:

To ensure optimum ingress protection of IP65 and IP67, you are recommended to change the battery cover after two years of usage.

The radio is submersible (compliant with the IP67 standard) – but only with the battery cover and the antenna attached.

To clean your radio and ensure that it is dust-free, use a moistened or antistatic/lint-free cloth to clean the battery cover seal and housing sealing surface.

C.4.1

## Preventive Maintenance

### Keeping Your Radio Dry

If your radio is submerged in water, shake off excess water and dry the radio with a towel. Take extra care when removing water trapped in the crevices and battery cover latch area of the radio, especially areas highlighted in [Figure 19: Areas to Keep Dry on page 111](#).

**IMPORTANT:** To avoid compromising the ingress protection of IP67, do not remove the seal label at the side of the radio. See [ST7500 Controls and Indicators on page 26](#).

Figure 19: Areas to Keep Dry

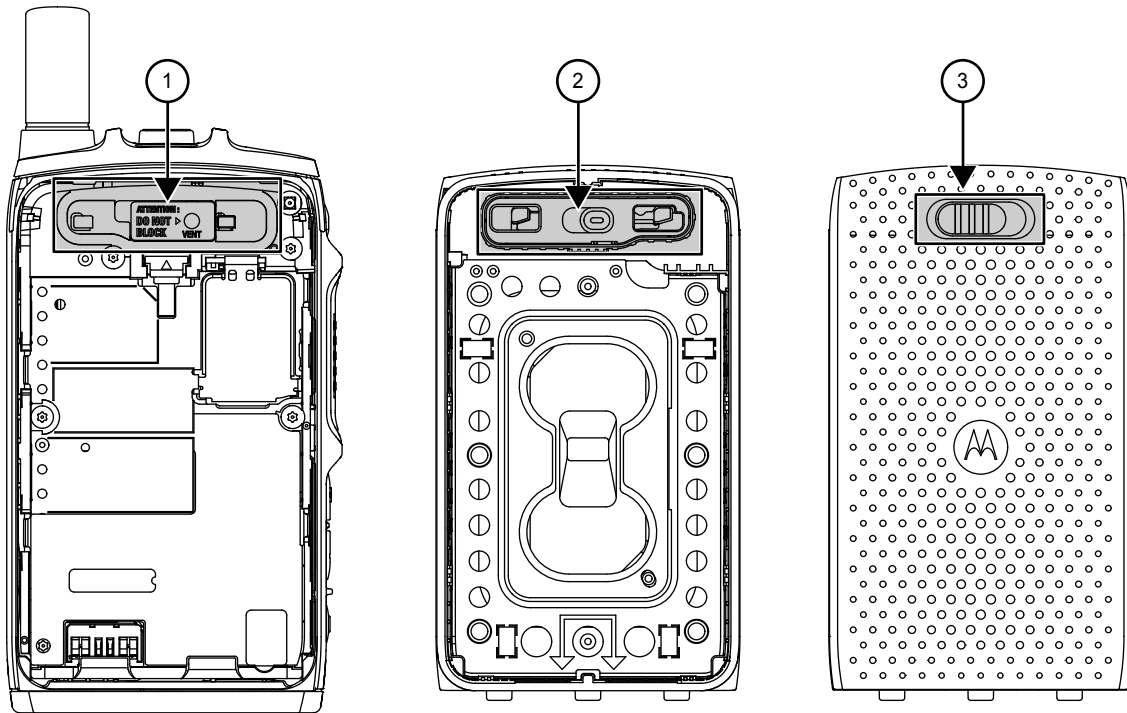

Table 24: Areas to Keep Dry

Annotation	Radio Section	Description
1	Radio Back View	Wipe dry after removing radio from water immersion.
2	Battery Cover Internal View	
3	Battery Cover External View	Wipe dry the Battery Cover Latch as water may penetrate into latch area.

### Cleaning Bottom Connector Contacts

**IMPORTANT:** For reliable performance, it is important to ensure that the electrical contact interface remains clean and free of foreign material.

The contact material technologies used in the radio are engineered to provide a reliable interconnection.

To maintain optimal performance of the contact interface, Motorola Solutions recommends inspecting and cleaning the contacts every six months or before radio programming. Use a lint-free swab applied with isopropyl alcohol (100% by volume) to wipe or remove any dirt or foreign material from the contact pads.

You can also clean and protect the contacts with a CAIG DeoxIT® GOLD G100P Pen Applicator<sup>1</sup>. Motorola Solutions recommends the pen-based package for better cleaning action and access to contacts.

Before applying the lubricant/cleaner, wipe the contacts with lint-free swabs to remove any dirt or foreign material. Then, clean the bottom connector contact as per the instructions from the DeoxIT GOLD manufacturer.

---

<sup>1</sup> The CAIG DeoxIT GOLD G100P Pen Applicator is available at numerous electronics suppliers and directly from the manufacturer.