

Mobile Release 17M



MTP850 FuG Product Information Manual

MARCH 2018

© 2018 Motorola Solutions, Inc. All rights reserved



68015000878-HC

Copyrights

The Motorola Solutions products described in this document may include copyrighted Motorola Solutions computer programs. Laws in the United States and other countries preserve for Motorola Solutions certain exclusive rights for copyrighted computer programs. Accordingly, any copyrighted Motorola Solutions computer programs contained in the Motorola Solutions products described in this document may not be copied or reproduced in any manner without the express written permission of Motorola Solutions.

© 2018 Motorola Solutions, Inc. All Rights Reserved

No part of this document may be reproduced, transmitted, stored in a retrieval system, or translated into any language or computer language, in any form or by any means, without the prior written permission of Motorola Solutions, Inc.

Furthermore, the purchase of Motorola Solutions products shall not be deemed to grant either directly or by implication, estoppel or otherwise, any license under the copyrights, patents or patent applications of Motorola Solutions, except for the normal non-exclusive, royalty-free license to use that arises by operation of law in the sale of a product.

Disclaimer

Please note that certain features, facilities, and capabilities described in this document may not be applicable to or licensed for use on a particular system, or may be dependent upon the characteristics of a particular mobile subscriber unit or configuration of certain parameters. Please refer to your Motorola Solutions contact for further information.

Trademarks

MOTOROLA, MOTO, MOTOROLA SOLUTIONS, and the Stylized M Logo are trademarks or registered trademarks of Motorola Trademark Holdings, LLC and are used under license. All other trademarks are the property of their respective owners.

European Union (EU) Waste of Electrical and Electronic Equipment (WEEE) directive



The European Union's WEEE directive requires that products sold into EU countries must have the crossed out trash bin label on the product (or the package in some cases).

As defined by the WEEE directive, this cross-out trash bin label means that customers and end-users in EU countries should not dispose of electronic and electrical equipment or accessories in household waste.

Customers or end-users in EU countries should contact their local equipment supplier representative or service centre for information about the waste collection system in their country.

This page intentionally left blank.

Contents

Copyrights.....	3
List of Figures.....	11
List of Tables.....	13
Icon Conventions.....	15
Chapter 1: Product Overview.....	17
1.1 MTP850 FuG Overview.....	17
1.1.1 MTP850 FuG Specifications.....	18
1.2 Ordering Options for Radios and Features.....	19
1.3 Radio Ordering.....	19
1.4 Customer Programming Software.....	20
Chapter 2: Services and Features.....	21
2.1 System Support.....	21
2.2 Trunked Mode Operation.....	21
2.3 Direct Mode Operation.....	22
2.4 Numbering and Addressing.....	22
2.5 Dialing Methods.....	23
2.5.1 Talkgroup Dialing by Index.....	23
2.5.2 Individual Dialing.....	24
2.6 Unified Address Book.....	24
2.7 Call History.....	25
2.8 Group Call.....	25
2.8.1 Programmable Talkgroups.....	25
2.8.2 Talkgroup Folders.....	26
2.8.3 Talkgroup Selection.....	27
2.8.4 Favorite Folders.....	27
2.8.5 Talkgroup Blind Operation.....	27
2.8.6 Receive-only Talkgroups.....	27
2.8.7 Non-Selectable Talkgroups.....	27
2.8.8 Transmission Timeout Timer.....	28
2.8.9 Group Call Reception.....	28
2.8.10 Talkgroup Scanning.....	28
2.8.11 Priority Monitor.....	29
2.8.12 Announcement Talkgroups.....	29
2.8.13 Broadcast Call Initiated by User.....	29
2.8.14 Timed Talkgroup Change.....	30

2.8.15 Broadcast Call.....	30
2.8.16 Announcement Call.....	30
2.8.17 PTT Double Push.....	31
2.8.18 PTT Queue.....	31
2.8.19 Talking Party Identification.....	31
2.8.20 Call Ownership.....	31
2.8.21 Transmission During Group Call.....	32
2.8.22 Call Restoration.....	32
2.8.23 Temporary Group Address.....	32
2.8.24 Late Entry.....	32
2.8.25 User Initiated Group Attachment.....	32
2.9 Private Call.....	33
2.9.1 Simplex Private Call.....	33
2.9.2 Duplex Private Call.....	34
2.9.3 Transmission Timeout Timer.....	34
2.9.4 Call Restoration in Private Call.....	34
2.9.5 Assistance Call.....	34
2.9.6 DMO Individual Call Presence Check.....	34
2.9.7 DMO Individual Only Talkgroups.....	35
2.9.8 Private Calls through DMO Gateway.....	35
2.10 Phone Call.....	35
2.10.1 Phone Call Initiation.....	35
2.10.2 Phone Call Reception.....	36
2.10.3 Call Restoration in Phone Call.....	36
2.11 Emergency Operations.....	36
2.11.1 Emergency Group Call.....	36
2.11.2 Non-Tactical Emergency.....	37
2.11.3 Emergency Individual Calls (Private or MSISDN).....	37
2.11.4 Emergency Alarm.....	37
2.11.5 Emergency SDS Status.....	38
2.11.6 Emergency Hot Microphone.....	38
2.11.7 Alternating Hot Microphone.....	38
2.11.8 Silent Emergency Mode.....	39
2.11.9 Invisible Emergency.....	39
2.11.10 Disaster Alert.....	39
2.12 Short Data Services.....	40
2.12.1 Status Messages.....	40
2.12.2 Shadow Groups (Address Bundle).....	41
2.12.3 Text Messages.....	42

2.12.3.1 Buffer Full Overwrite Policy.....	43
2.12.3.2 SDS Messages Concatenation.....	43
2.12.4 Immediate Text Messages.....	44
2.12.5 Home Display Text Message.....	44
2.12.6 Predefined Templates (ATS Entry Prompt).....	44
2.12.7 SDS Air Interface Aspects.....	44
2.12.8 SDS Encryption.....	45
2.12.8.1 SDS End-to-End Encryption.....	45
2.12.9 Store and Forward.....	47
2.12.10 SDS Receive Failure Notification.....	47
2.13 Security Services.....	47
2.13.1 Terminal Equipment Identity.....	47
2.13.2 PIN/PUK User Authentication.....	48
2.13.3 Authentication.....	48
2.13.4 Air Interface Encryption.....	48
2.13.4.1 Clear Radios (Class 1).....	49
2.13.4.2 Static Cipher Key Encryption (Class 2).....	49
2.13.4.3 Derived Cipher Key and Common Cipher Keys Encryption (Class 3).....	49
2.13.4.4 Group Cipher Keys Encryption (Class 3G).....	50
2.13.4.5 Over-the-Air-Rekeying.....	50
2.13.4.6 Encryption Mobility.....	51
2.13.4.7 Encryption MMI.....	51
2.13.4.8 AIE Key Storage.....	52
2.13.4.9 Deleting User Keys.....	52
2.13.5 Secure DMO.....	52
2.13.6 End-to-End Encryption.....	53
2.13.7 SIM Security.....	53
2.13.8 Radio Disable or Enable.....	54
2.13.9 Radio Permanent Disable.....	54
2.13.10 Radio Permanent Disable v2.....	55
2.13.11 High Assurance Boot.....	55
2.14 Packet Data.....	56
2.14.1 Voice and Data Support.....	57
2.14.2 Packet Data IP Addressing.....	58
2.14.3 Packet Data User Authentication.....	58
2.15 TETRA Network Protocol 1.....	58
2.15.1 TETRA Network Protocol 1 IP Addressing.....	59
2.16 Mobility Services.....	59
2.16.1 Main Control Channel Frequencies.....	59

2.16.2 Control Channel Selection.....	60
2.16.3 Registration.....	60
2.16.4 Call Roaming.....	61
2.16.5 Seamless Handover.....	62
2.16.6 Networks.....	62
2.16.6.1 Migration.....	63
2.16.6.2 Network Selection.....	63
2.16.7 Congested Cell Handling.....	64
2.16.8 Subscriber Class.....	64
2.16.9 Subscriber Class by Talkgroup.....	64
2.16.10 RF Power Class Toggle.....	65
2.16.11 Local Site Trunking.....	65
2.17 Supplementary Services.....	66
2.17.1 Dynamic Group Number Assignment.....	66
2.17.2 Ambience Listening.....	67
2.17.3 Pseudo Power-Off.....	68
2.17.4 Auto Power-On.....	68
2.17.5 Preemptive Priority Call.....	68
2.17.6 Transmit Inhibit Mode.....	68
2.17.7 Calling Line Identification Presentation.....	69
2.17.8 DTMF Overdial.....	69
2.17.9 Universal Time Display.....	70
2.18 Man Down.....	70
2.18.1 Man Down (Operation).....	70
2.19 Vibrate Alert.....	71
2.20 Repeater Mode.....	71
2.21 DMO Gateway and Repeater Communication.....	72
2.21.1 Communication through Repeaters.....	72
2.21.2 Communication through Gateways.....	73
2.21.3 SDS through DMO Gateways or Repeaters.....	74
2.21.4 Gateway and Repeater Synchronization.....	74
2.22 SDS Remote Control.....	74
2.23 Status Remote Control.....	76
2.24 Call-Out.....	76
2.24.1 Call-Out Interactions.....	78
2.25 Radio Messaging System.....	78
2.26 Global Navigation Satellite System (GNSS) Location Service.....	79
2.26.1 Military Grid Reference System.....	82
2.26.2 Different Location Displays.....	83

2.26.3 Global Navigation Satellite System (GNSS) Accuracy.....	83
2.27 Wireless Application Protocol (WAP).....	84
2.27.1 WAP Browser.....	84
2.27.2 WAP Push.....	84
2.28 Radio User Assignment and Radio User Identity.....	84
2.28.1 RUA/RUI Log On	85
2.28.2 RUA/RUI Radio Behavior.....	85
2.28.3 RUA/RUI Interactions.....	85
Chapter 3: Man-Machine Interface.....	87
3.1 LED Indications.....	87
3.2 Battery Charging Indications.....	87
3.3 Controls and Indicators.....	88
3.4 Keypad Lock.....	90
3.5 Automatic Keypad Lock.....	91
3.6 One-Touch Buttons.....	91
3.7 Display.....	93
3.7.1 Status Icons.....	94
3.7.2 Idle Display.....	98
3.7.3 Configurable Idle Screen.....	98
3.7.4 Display Features.....	99
3.7.5 Languages Supported.....	99
3.8 Tones.....	100
3.9 Dual Microphones.....	102
3.10 Audio Toggle.....	102
3.11 Volume Adjustment Mode.....	102
3.12 Accessory Setup.....	102
3.13 Audio Features.....	103
3.13.1 Audio Profiles.....	103
3.13.2 Audio Templates Names and Availability.....	103
3.13.3 Transmit Automatic Gain Control.....	104
3.13.4 Howling Suppression.....	104
3.14 Test Page.....	105
3.15 Radio Info.....	106
3.16 Hardware Test.....	106
Appendix A: Service Information – EIA.....	109
Appendix B: Service Information – AME.....	111
Appendix C: Service Information – Americas.....	115

This page intentionally left blank.

List of Figures

Figure 1: MTP850 FuG.....	17
Figure 2: Trunked Mode Operation.....	22
Figure 3: Direct Mode Operation.....	22
Figure 4: Talkgroup Tree.....	26
Figure 5: SDS End-to-End Encryption.....	46
Figure 6: Voice and Data End to End Encryption.....	53
Figure 7: Repeater Mode Operation.....	71
Figure 8: Communication through Repeaters.....	73
Figure 9: Communication through Gateways.....	73
Figure 10: SDS Remote Control Overview.....	75
Figure 11: RMS Flow Model with SDS TL.....	78
Figure 12: RMS Flow Model with STS TL.....	79
Figure 13: Default Home Screen with Icons.....	93

This page intentionally left blank.

List of Tables

Table 1: General Technical Specification.....	18
Table 2: RF Specification.....	19
Table 3: GPS Specification.....	19
Table 4: Maximum SDS Lengths with Encryptions.....	42
Table 5: Security Features Required Per Security Class.....	48
Table 6: Packet Data IP Addressing.....	58
Table 7: TETRA Network Protocol 1 (TNP1) IP Addressing.....	59
Table 8: GNSS Triggers.....	81
Table 9: Different Location Displays.....	83
Table 10: LED Status Indications.....	87
Table 11: Battery Icons.....	87
Table 12: Controls and Indicators.....	89
Table 13: One-Touch Button Features	91
Table 14: Display.....	93
Table 15: Colors of the Soft Key Area.....	94
Table 16: Status Icons.....	94
Table 17: Languages Supported.....	99
Table 18: Radio Tones.....	100
Table 19: Available Audio Templates.....	103
Table 20: Service Information — Telephone Numbers to EIA Integrated Call Center.....	109
Table 21: Service Information – Telephone Numbers and Addresses of the Asia and Pacific Motorola Solutions Centers.....	111
Table 22: Service Information – Telephone Numbers and Addresses of Latin America Radio Support Centers.....	115
Table 23: Service Information – Telephone Numbers and Addresses of Latin America Motorola Solutions Centers.....	115

This page intentionally left blank.

Icon Conventions

The documentation set is designed to give the reader more visual clues. The following graphic icons are used throughout the documentation set.



DANGER: The signal word DANGER with the associated safety icon implies information that, if disregarded, will result in death or serious injury.



WARNING: The signal word WARNING with the associated safety icon implies information that, if disregarded, could result in death or serious injury, or serious product damage.



CAUTION: The signal word CAUTION with the associated safety icon implies information that, if disregarded, may result in minor or moderate injury, or serious product damage.

CAUTION: The signal word CAUTION may be used without the safety icon to state potential damage or injury that is not related to the product.



IMPORTANT: IMPORTANT statements contain information that is crucial to the discussion at hand, but is not CAUTION or WARNING. There is no warning level associated with the IMPORTANT statement.



NOTICE: NOTICE contains information more important than the surrounding text, such as exceptions or preconditions. They also refer the reader elsewhere for additional information, remind the reader how to complete an action (when it is not part of the current procedure, for instance), or tell the reader where something is on the screen. There is no warning level associated with a notice.

This page intentionally left blank.

Chapter 1

Product Overview

1.1

MTP850 FuG Overview

The MTP850 FuG is Motorola Solutions TETRA portable radio for mission critical communications. Incorporating all features of the MTP850, this radio includes an advanced Man Down sensor for exceptional user safety together with a new side connector for increased ruggedness.

Figure 1: MTP850 FuG



Providing higher power increases range and in-building performance, and so Motorola Solutions has added Class 3L (1.8 W) power output option. Taken together with high receive sensitivity, the MTP850 FuG maintains communications in the most demanding situations.

The MTP850 FuG has improved operational effectiveness through:

- Access to information databases through integrated WAP browser - decide based on the latest information.
- Update your availability and situation using Status Messaging - monitor the progress of job assignments, or call for support when needed.
- Integrated GPS. Knowing where your resources are enables you to allocate tasks based on up-to-date information.

The MTP850 FuG has improved safety features through:

- Improved coverage in DMO operation, ensuring that users can communicate over a wider area or in buildings or built-up areas.
- If the radio does not move in a specific time period, the Man Down feature sends an alert to the console operator.
- If the radio tilts more than the programmed angle, the Man Down feature sends an alert to the console operator.
- Silent emergency, hitting the emergency button alerts colleagues to critical situations but sends and updates your location, without showing any indication on the radio screen.

- Rugged side connector. This new side connector with the range of available accessories ensures that connection is maintained even in the most violent of situations.

1.1.1

MTP850 FuG Specifications

Table 1: General Technical Specification

Parameter	Value
Dimensions H x W x D mm	125 x 59 x 36 (with standard 1850 mAh battery)
Weight g	174, radio only 234, with 1850 mAh battery
Battery Operating Life (Time Expected)	Class 4 (1 W) > 23 hr Class 3L (1.8 W for 380–430 MHz only) > 20.5 hr
05/05/90	> 17 hr
05/35/60	3.5 hr
Talk Time	2.5 hr
Color Display	130 x 130 pixel screen size with 65536 vivid colors flip screen and large text options
TMO Talkgroups	4,000 Entries (up to 2,048 entries in one folder) 10,000 Unique TMO Talkgroup
DMO Talkgroups	2,000 Unique DMO Talkgroups
TMO Folders	256
DMO Folders	128
Favorite Groups	384 (3 Favorite Groups folders containing up to 128 entries each)
Contact List	1,000 Contacts Up to six entries (numbers) per contact Maximum 2,000 entries
Text Message List	100 Short and 20 Long Messages for Outbox 100 Short and 10 Long Messages for Inbox
Status List	400 Entries
Country Code/Network Code List	100 Entries
Scan List	40 Lists of 20 Groups
Operating Temperature °C	-30 to +60
Storage Temperature °C	-40 to +85
Humidity	ETSI 300 019-1-7 class 7.3E
Dust and Water	IP55 per IEC 60529
Shock (Mechanical), Drop, and Vibration	ETSI 300-019 1-7 class 5M3 (Shock: Type I, 18 shocks total)

Table 2: RF Specification

Parameter	Value
Frequency Bands MHz	380–430
RF Channel Bandwidth kHz	25
Transmitter RF Output Power W	1 (Class 4) and 1.8 (Class 3L)
RF Power Control	3 Steps of 5 dB
RF Power Level Accuracy +/-dB	2
Adaptive Power Control	A and B
Receiver Class	A and B
Receiver Static Sensitivity dBm	-112 minimum (-115 typical)
Receiver Dynamic Sensitivity dBm	-103 minimum (-107 typical)

Table 3: GPS Specification

Parameter	Value
Simultaneous Satellites	12
GPS Antenna	Helical - integrated into TETRA Antenna
Sensitivity	-152 dBm / -182 dBW
Accuracy (Measured at -137 dBm)	5 meters - 50% probable 10 meters - 95% probable
Protocols	ETSI LIP & Motorola LRRP



NOTICE: This specification may be subject to change without further notice. All product features are subject to infrastructure support. Selected features are subject to optional software upgrade.

1.2

Ordering Options for Radios and Features

TETRA terminals are sold directly to users by Motorola Solutions or are available through accredited channel partners.

Software options can be ordered and enabled in two ways:

- Enabled at the Distribution Center (DC).
- Enabled with a license in the Integrated Terminal Management (iTM) or Customer Programming Software (CPS).

1.3

Radio Ordering

Procedure:

- 1 Order the main radio model.
- 2 Order options from each of the following categories:
 - Software Selling Features

- Customer Programming Software
- Integrated Terminal Management
- Accessories



NOTICE: Export controls apply when ordering encryption.

1.4

Customer Programming Software

For information about Customer Programming Software, see the *TETRA Terminals CPS Plus Start-up User Guide*.

Chapter 2

Services and Features

2.1

System Support

The radio operates on the Dimetra IP 5.x, 6.x, 7.x and 8.x releases and Dimetra IP Compact. It also operates on previous versions of Dimetra; from Release 3.8 and on.

The radio is designed to operate optimally on the Dimetra IP system. The radio operates properly on all SwMIs that comply with the below list of IOP features defined by the TETRA And Critical Communications Association (TANDCCA). Official IOP certificates can be downloaded from the TANDCCA web page at <http://www.tandcca.com/interoperability/interoperability-certificates-and-test-reports/>.

TMO TIP:

- TIP Core TTR 001-01, TIP – Part 1: Core
- TIP SDS TTR 001-02, TIP – Part 2: Short Data Service
- TIP DGNA TTR 001-03, TIP – Part 3: Dynamic Group Number Assignment
- TIP Auth TTR 001-04, TIP – Part 4: Authentication
- TIP PD TTR 001-05, TIP – Part 5: Packet Data
- TIP AI Migration TTR 001-06, TIP – Part 6: Air Interface Migration
- TIP FSSN TTR 001-07, TIP – Part 7: Fleet Specific Short Number
- TIP SS-AL TTR 001-09 TIP – Part 9: Ambience Listening
- TIP E2EE TTR 001-10, TIP – Part 10: End to End Encryption (Selling option)
- TIP AIE TTR 001-11 TIP – Part 11: Air Interface Encryption
- TIP SI TTR 001-12, TIP – Part 12: Service Interaction
- TIP Disable TTR 001-13 TIP – Part 13: Enable or Disable
- TIP LIP TTR 001-19, TIP – Part 19: Location Information Protocol
- TIP CF TTR 001-20, TIP – Part 20: Call Forwarding
- TIP Callout TTR 001-21, TIP – Part 21: Call Out

DMO TIP:

- TIP DCore TTR 002-01, DMO TIP – Part 1: DMO Core
- TIP DGate TTR 002-02, DMO TIP – Part 2: DMO Gateway
- TIP DRep TTR 002-03, DMO TIP – Part 3: DMO Repeater Type 1
- TIP DE2EE TTR 002-04, DMO TIP – Part 4: DMO End to End Encryption
- TIP DAIE TTR 002-05, DMO TIP – Part 5: DMO Air Interface Encryption

2.2

Trunked Mode Operation

Trunked Mode Operation (TMO) requires the switching and management infrastructure.

This operation mode enables various voice and data communication types, such as group calls and short data service messages, as well as access to the infrastructure-related features such as packet data.

Figure 2: Trunked Mode Operation

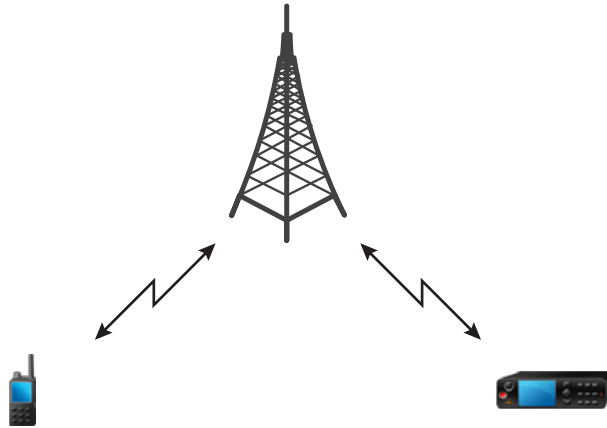

2.3

Direct Mode Operation

Direct Mode Operation (DMO) is a mode of simplex operation where radios communicate directly without the need of a network.

Figure 3: Direct Mode Operation

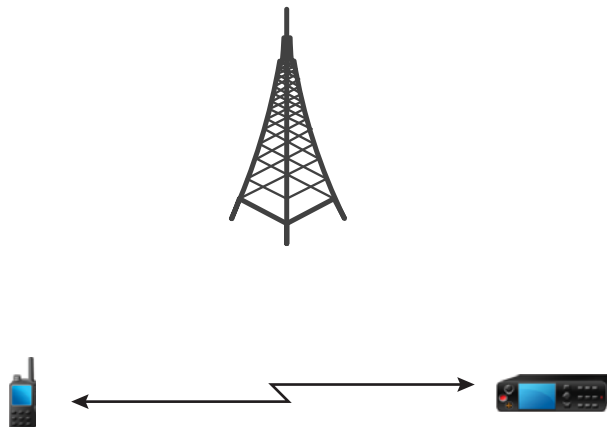

2.4

Numbering and Addressing

Each radio has an Individual TETRA Subscriber Identity (ITSI) used for addressing the radio over the air interface.

However, it is undesirable to require you to enter a long number to address another radio. To this end, a set of short number schemes can be used. Alternatively, the radio can be provisioned to treat a short

number as a Short Subscriber Identity (SSI). This scheme can be refined to allow short dialing within a fleet by combining the ID entered with the radio own SSI.

If the radio is provisioned to treat a short number as a TETRA SSI, and the number entered is fewer than seven digits, the identity of the radio is combined with the number entered to produce the actual Individual Short Subscriber Identity (ISSI). Using this scheme, an ISSI can comprise of a fleet number part and a member part.

The ISSI of the radio is used to determine the leading digits for the digits omitted as in the following scenario:

- 1 The radio has the following ID: 1234567
- 2 You enter: 890
- 3 The SSI sent is: 1234890

The following services can use the short SSI for identification of both the called and the calling parties:

- Duplex private call
- Simplex private call
- Group call
- Mobile status
- Short data bearer service
- Text message service

If you are provisioned with the capability of entering a real TETRA ISSI and you enter an ID of seven digits, the number is interpreted as a real TETRA ISSI regardless of the short addressing scheme used.

2.5

Dialing Methods

The radio supports multiple methods of selecting a number for an outgoing call.

- Using predefined One-Touch Buttons.
- Dialing from the favorite folders.
- Dialing from the address book.
- Dialing from the Recent Calls list.
- Direct dialing.
- Dialing from the embedded numbers in SDS messages.
- Speed dialing.
- Talkgroup dialing by index.

2.5.1

Talkgroup Dialing by Index

Talkgroup dialing by index allows a radio to make group calls using the talkgroup speed dial number, or in other words, the Talkgroup ID, or Index.

With the talkgroup dialing by index option enabled, you can use the keypad and enter the talkgroup speed dial number followed by the * key. For example, to call a talkgroup whose ID is 19, enter **1, 9,** and * from the keypad and then select the **Attach** soft key when viewing the offered talkgroup information. To start the group call, press the **PTT** button.

2.5.2

Individual Dialing

The Individual Call feature consists of Telephone Interconnect feature and the Private Call feature.

The Phone or PABX feature allows you to make a Phone or PABX call by a shortened number of up to three digits instead of the full number. The Phone or PABX speed dial number is assigned when the dialed number is added in the contact list.

You can re-dial numbers from the call history list by pressing the down scroll key.

The private ID number is a number with up to 16 digits. If you enter fewer than 16 digits, the Individual Short Subscriber Identity (ISSI) part is padded to full Individual TETRA Subscriber Identity (ITSI) with leading zeros. The private ID number consists of the following items with their respective dialing scheme:

- Mobile Country Code (MCC) 15-13
- Mobile Network Code (MNC) 12-9
- Individual Short Subscriber Identity (ISSI) 8-1



NOTICE: For the MNC of a private ID (digits 12-9), values from 0000 to 9999 are accepted.

The Migration mode supports three types of relative dialing and which Mobile Network Identity (MNI) is assumed when the radio dials an ISSI:

- Relative to Switching and Management Infrastructure (SwMI) - the radio uses the MNI of the current SwMI.
- Relative to radio MNI - the radio uses its home MNI.
- Relative to current MNI - the radio uses its home MNI when it migrates to another network or the MNI of the SwMI when the radio has ITSI attached to another network.

Two options are given to the user:

Fixed

Provides up to 16 digits which include the MCC, MNC, and ISSI numbers. If you enter fewer than 16 digits, then the rest is filled with the digits that are set in the codeplug.

Automatic

Provides up to eight digits. If you provide more, it switches to fixed mode. If you enter fewer than 16 digits, the radio fills the rest of the number with its own ITSI.

If you try to enter more than 16 digits, you receive a prompt informing about an incorrect input.

If the One-Touch Button is provisioned, you can call an individual by pressing and holding down one of the programmable buttons.

2.6

Unified Address Book

The radio offers an address book facility, where multiple numbers are associated with a single name tag. This facility presents an interface to the address book and provides a natural way to call an individual who can be contacted in different ways.

Each individual can have up to six associated numbers:

- Private (a TETRA ISSI or ITSI)
- Home (phone number)
- Mobile (phone number)
- Work (phone number)

- PABX (local short number)
- Other (phone number)

The Contact List has a maximum capacity of 2,000 Contacts, with up to 1,000 associated Private and up to 1,000 associated either Phone or PABX numbers distributed among the contacts.

The radio provides editing capabilities to the address book to allow adding or deleting entries. It also provides the possibility to view the number of used and free address book entries.

The address book is also accessible through PEI. Using the PEI enables you to read, write, and modify contact list entries using AT commands.

2.7

Call History

A call history list consists of the following items:

- Last dialed numbers
- Missed call numbers
- Answered (Received) call numbers

Additionally, the time a call is established and all call duration are available. To view call history, press the down scroll key.

The Call History stack holds private TETRA IDs as well as phone and PABX numbers.

Numbers from the stack may be viewed, selected, and called. However, outgoing duplex calls from Recent Calls list display in DMO are not allowed. When you scroll through the lists, the entries appear in the opposite order (the most recent entry is shown first).

When a call is made to a number that exists in the last dialed list, this number is not duplicated in the list and is moved to the beginning of the list. However, a missed call and received entries are duplicated in the corresponding call list.

The call history lists are available after next power-up.

You can save a number from the call history stack to the address book.

2.8

Group Call

The group call service enables the radio to communicate with a group of other TETRA radios using point to multi-point operation.

This service is available in both TMO and DMO. You can initiate a new group call to the selected talkgroup or talk back to the existing group call by pressing the PTT button.

2.8.1

Programmable Talkgroups

The radio offers a talkgroup list facility. Each talkgroup entry contains a TETRA group address and may be associated with a name tag. The talkgroups can be defined in the codeplug as per the radio capabilities.

Talkgroups are configured separately for TMO and DMO modes. To program a talkgroup in TMO define its name and Group Short Subscriber Identity (GSSI). To program a talkgroup in DMO define its name, Group TETRA Subscriber Identity (GTSI) and frequency. The radio operator can select a talkgroup which has an associated TMO or DMO frequency depending on the mode selected. When switching between the TMO and DMO modes the last active talkgroup is selected. However the required talkgroup can be mapped in CPS. In such a case a corresponding talkgroup is automatically selected during mode switching, regardless of the previously selected talkgroup.

 **NOTICE:** Neither the group name nor the corresponding group address can be edited using the radio MMI.

A talkgroup linked to several networks produces as many new unique talkgroups as the networks it associates with. For example, if the talkgroup has the same GSSI and network in several talkgroup folders, one unique talkgroup is created. Alternatively, if the talkgroup has the same GSSI but with different networks in several talkgroup folders, several unique talkgroups are created for each network.

The GTSI indicates the talkgroup uniqueness. It is a combination of the GSSI and the network associated to the talkgroup in the given talkgroup folder. The talkgroup folders do not determine the uniqueness of the new talkgroups.

2.8.2

Talkgroup Folders

The talkgroups are organized in folders. You can select a talkgroup by first choosing a folder and then the talkgroup in the folder. The size of each folder is flexible and can be defined through provisioning.

The talkgroup folders are organized in a tree-structure:

- Level 1 Folders
 - Placed at the root of the folder structure.
 - Can contain both level 2 folders and talkgroups at the same time.
 - Can contain any number of level 2 folders.
- Level 2 Folders
 - Placed in level 1 folders.
 - Any given level 2 folder can only be sub-folder to one level 1 folder.



 **NOTICE:** The radio supports up to three levels of folders.

Figure 4: Talkgroup Tree

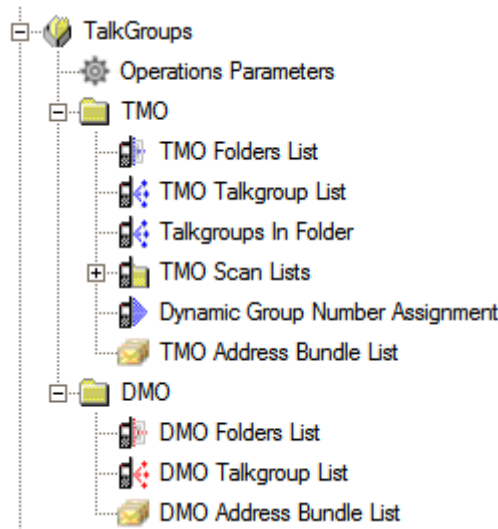

A maximum of 256 folders is allowed, regardless of their level.

 **NOTICE:** The folder definitions cannot be changed using the radio MMI. Any talkgroup folder or sub-folder which is either empty or does not contain any programmed talkgroups is hidden in the MMI.

2.8.3

Talkgroup Selection

Talkgroup selection from the stored talkgroups list in the idle mode can be performed by scrolling through the list using the scroll keys.

You can also scroll using the **rotary knob**. Talkgroup scrolling can be provisioned to scroll in a folder only, or continuously through the folders acting as one continuous list of groups. The radio does not allow directly dialing a group Short Subscriber Identity (SSI).

2.8.4

Favorite Folders

You can add frequently used talkgroups and phone book contacts to the Favorite folder. You can add items from Favorites or Talkgroups and Contacts menu levels respectively.

This feature allows quick access to frequently used talkgroups by including the groups in up to three favorite talkgroups ranges. These ranges are separately stored in the data storage. The feature operates in both Trunked Mode Operation (TMO) and Direct Mode Operation (DMO) modes. The favorite talkgroups ranges are shared for TMO and DMO talkgroups. Press the **Up** scroll key to select, view, and edit **My Groups** ranges. Once a group from the **My Groups** range is selected, you can select any of the favorite talkgroups in that range using normal procedure.

A favorite talkgroup range name replaces a talkgroup range name on the radio display whenever a favorite talkgroup is selected, or is in use for appropriate operation. The ranges of favorite talkgroups with their talkgroup assignments are kept through the radio power cycle.

2.8.5

Talkgroup Blind Operation

The radio can be provisioned with a virtual scrolling end-stop option for use in blind operation.

When you have scrolled to the beginning or the end of the list, the first or the last talkgroup is displayed even if you continue to scroll. A tone is emitted when the upper or lower virtual end-stop is reached. To change this setting for the **Rotary Knob**, you can select **Wrap around Rotary Knob Group Scrolling** option in the Customer Programming Software (CPS).

2.8.6

Receive-only Talkgroups

Talkgroups can be provisioned as receive-only talkgroups. This setting depends on the settings of the folder the talkgroup is in. Any talkgroup from the receive-only folder can be selected. The radio allows you to receive calls, however, no call can be initiated to this talkgroup.

2.8.7

Non-Selectable Talkgroups

A talkgroup can be provisioned as a non-selectable talkgroup. Such talkgroups are not visible when scrolling through the talkgroup list, and thus cannot be selected.

The group name is displayed only upon receiving a call for the group, for instance, if it is an announcement talkgroup associated with the selected group, or if it is a scanned one. The radio user is not allowed to edit the scan list.

2.8.8

Transmission Timeout Timer

The radio limits the time you can continuously talk in a group call without interruption, according to a provisioned value. You are warned a short time before the talk time expires. The timer is provisioned per talkgroup folder.

2.8.9

Group Call Reception

In most situations, the radio receives group calls without any intervention. When the radio receives an incoming group call, you are alerted with a short alert tone. Depending on the configuration, the tone can be disabled. Then the speech follows.

To clear a call ended by the call owner, normally by the SwMI, you do not need to do anything. However, you can leave a group call. Then the call continues for other radios, even though your radio does not participate in the call anymore.

2.8.10

Talkgroup Scanning

Talkgroup scanning allows the radio to monitor signaling of a few talkgroups at the same time. In addition to monitoring signaling addressed to the selected talkgroup, the radio can monitor signaling addressed to multiple talkgroups.

To use the multiple group monitoring, define a scan list which is a user-activated scan list. The radio can allow creating and editing the scan list using MMI. This list holds up to 20 talkgroups, which you monitor in addition to the selected group.

You can choose only one user-activated scan list at a time. When this list is activated, the radio begins to monitor traffic for these groups in addition to the traffic for the selected group. Up to 40 scan lists can be defined.

If the SwMI instructs a radio to detach one of the scanned groups, the radio stops monitoring the group, but the group remains in the scan list. Subsequent attachment of a group by the SwMI causes the radio to begin monitoring the group again.

The SwMI may also instruct a radio to attach groups from out of the scan list. If the group attachment is accepted, the radio monitors the group.

If talkgroups have been attached or are always attached, the radio may passively monitor the following talkgroups:

- Selected talkgroup.
- Announcement Talkgroup (ATG) associated with the selected talkgroup (if this talkgroup is not set as **Permanently detach**).
- Talkgroups associated with the selected ATG (if this talkgroup is not set as **Permanently detach**).
- Talkgroups in the user-activated scan list (if scanning is enabled and the SwMI-initiated detachment has not been performed on these groups).
- Talkgroups in the SwMI-controlled scan list (if scanning is enabled).
- Talkgroups with the class of usage set to **Always Scanned** (if supported).

2.8.11

Priority Monitor

While the radio is active in a group call, it may receive a group call setup for a different group. The radio decides whether to ignore the new call or accept it basing on the call priority. If the new call has the higher priority than the current one, the new call may be joined and the current call is dropped.

The following priority types are applicable to calls:

- Call priority indicated in the call setup signaling.
- Priority of the group indicated by the Class of Usage (CoU) negotiated upon attachment.

If the old call and new call have different call priorities, the radio follows the call with the higher call priority. If the calls have the same call priority, the CoU priority of the group decides.

If a radio is in a group call, but is not currently the talking party, and detects a call setup for a different group with the same priority, it joins the call if a CoU priority is higher.

The radio can be set up not to immediately join the new higher priority call but to present the new call to the user before joining it. If so provisioned, you are given a choice of following the new higher priority call or staying with the present call.

The radio can be set up to treat a selected group call as a higher priority than a scan group call. This behavior occurs regardless of the priority of the calls or the groups.

2.8.12

Announcement Talkgroups

The radio supports a group hierarchy concept. An Announcement Talkgroup (ATG) is a talkgroup consisting of up to 20 talkgroups. One of the talkgroups is a master group. Only the master group can monitor the traffic of the ATG. Users of a subgroup cannot monitor the traffic of other subgroups.

Once you select an ATG, the radio monitors signals addressed to the ATG in addition to signals addressed to its selected talkgroup. The radio does not support active scan list while attached to an ATG.

Depending on the codeplug settings, the radio can be provisioned to initiate an announcement call. If it is not provisioned to do so, the radio can still initiate an emergency call to the ATG.

A talkgroup can be associated to only one ATG. An ATG cannot be associated to another ATG. An ATG has a higher priority than other group calls within the same call priority.

2.8.13

Broadcast Call Initiated by User

This feature allows you to make a Broadcast Call from the radio initiated on the predefined talkgroup. The alias (message) displayed during Broadcast Call, as well as the call priority and destination address (talkgroup), can be configured in codeplug. This feature can only be used in TMO mode.

During Broadcast Call, other features are impacted:

- No other services except emergency are allowed (same as in emergency mode).
- Hot Mic functionality cannot be used.
- When Broadcast Call begins, any other ongoing services are terminated.



NOTICE:

If the BSI feature (radio with a SIM Card) defines the type of encryption, the Broadcast Call is always clear. Otherwise if the radio uses other encryption service the type of the encryption used for that Call is up to the encryption settings of that service.

Not all infrastructures support this feature. Consult with your service provider before enabling this feature.

2.8.14

Timed Talkgroup Change

This feature allows switching between the original and the predefined Trunked Mode Operation (TMO) or Direct Mode Operation (DMO) talkgroup by using the One-Touch Button.

The radio attaches to the selected, predefined talkgroup only for a specified amount of time (**Functional Timer**). After the timer expires, the radio returns to the previously attached, original talkgroup. Returning to the original talkgroup can also be assigned to the second press action of the button.

Example: A campus university combines four buildings: A, B, C, and D. A security procedure is to raise an internal alarm for the building and then notify the entire campus. The staff in each campus building configures radios with three types of talkgroups.

- 1 Internal Communication Talkgroups – regular talkgroups for the entire campus and individual buildings to communicate between staff members.
- 2 Internal Alarm Talkgroups – emergency talkgroups, individual for each building.
- 3 External Alarm Talkgroup – an emergency talkgroup to alert the entire campus.

The staff in individual buildings uses the dedicated Internal Communication Talkgroups for daily routines and the Internal Alarm Talkgroup for safety procedures. The campus staff in every building also scans the External Alarm Talkgroup.

The campus IT administrator assigned in Customer Programming Software (CPS) the **Timed Talkgroup Change** function to a One-Touch Button to switch between the original Internal Communication Talkgroup, and the Internal Alarm Talkgroup. This way the radio users can immediately switch to the emergency talkgroup and start an internal emergency call.

One of the staff members in building A is in an emergency situation. The person presses the One-Touch Button to switch to the Internal Alarm Talkgroup and starts the emergency call. The other staff members in building A hear the voice communication on the Internal Alarm Talkgroup. It turns out that the emergency is serious and one of the building administrators starts the global alarm for all campus buildings.

2.8.15

Broadcast Call

Broadcast Call enables the dispatcher to transmit to all radios in the specific area. This call is only available on GMOI network.

The radio joins calls received with a communication type broadcast and displays a notification that this call is a broadcast call. Typically, this call type is addressed to the broadcast address (ISSI).

A broadcast call takes precedence over any other call that has the same or lower call priority.



NOTICE: The radio cannot initiate a broadcast call, however, the radio is able to initiate the "broadcast-type" call restricted to the particular talkgroup using the Announcement Call feature.

2.8.16

Announcement Call

This feature allows you to make a Broadcast Call from the radio initiated on the predefined talkgroup. The alias (message) displayed during Broadcast Call, as well as the call priority and destination address (talkgroup), can be configured in codeplug. This feature can only be used in TMO mode and on the GMOI network.

During Announcement Call, other features are impacted:

- No other services except emergency are allowed (same as in emergency mode)

- Hot Mic functionality cannot be used.
- When Announcement Call begins, any other ongoing services are terminated.

If the BSI feature (radio with a SIM Card) defines the type of encryption, the Broadcast Call is always clear. Otherwise if the radio uses other encryption service the type of the encryption used for that call is up to the encryption settings of that service.

Not all infrastructures support this feature. Consult your service provider before enabling it.

2.8.17

PTT Double Push

The PTT double push (D-PTT) feature enables the radio to generate a specific tone sent to other radios in the talkgroup. You can send the tone by pressing **PTT** twice, or pressing the preconfigured One-Touch Button once.

After the D-PTT tone is played, you can press and hold the **PTT** once again to get the permission to talk. Otherwise if you press the **PTT** while the D-PTT tone is played, it is ignored. D-PTT tone is not audible on sending radio.

To send the tone, you press the **PTT** twice in a period defined in Customer Programming Software (CPS). The D-PTT is triggered only when the radio is in idle or group call mode. The D-PTT tone is not played on the sending radio.

If the **PTT** is kept pressed after second press and the radio finishes sending the D-PTT tone it allows starting group call. You are notified of the behavior by the permission to talk tone after D-PTT tone ends. If **PTT** is released after the second press, only the D-PTT tone is sent.



NOTICE: The D-PTT tone is sent as voice, hence the receiving radio plays the sound no matter whether the feature is enabled on it.

You can adjust the D-PTT tone volume level in the speaker or earpiece of the sourcing radio. Disabling all the tones does not affect the sent tone volume. From the MMI, you can change the D-PTT tone to be single, double, or triple. The tone type can also be changed in the codeplug.

2.8.18

PTT Queue

PTT Queue allows you to configure the response to releasing **PTT** of the call originating radio. This feature also determines how to cancel waiting for the call when the infrastructure is busy and your call is queued.

2.8.19

Talking Party Identification

Radios engaged in a group call receives an ID of the transmitting party. The identification presentation functionality is supported mostly using the information found in the call setup messages.

2.8.20

Call Ownership

The radio can be given the call ownership of a talkgroup call. When the radio is the call owner, it sends an appropriate TETRA signaling to end the call.



NOTICE: The SwMI decides about the ownership of a call.

2.8.21

Transmission During Group Call

While receiving a group call, and the **PTT during received Group Call** is enabled, you may request to transmit by pressing and holding the **PTT**. The system registers this action and informs you that the request has been queued.

If you release the **PTT**, the radio sends a message to the system withdrawing the request.

2.8.22

Call Restoration

If the radio roams to a new cell during a call, it attempts to continue the call on the new cell. Cell reselection and call restoration procedures are employed for this attempt.

If the radio roams while being the transmitting party in the call, an announced cell reselection, if possible, is carried out in the new cell.

If the radio is not the transmitting party, it employs an unannounced cell reselection, followed by the call restoration procedures.

2.8.23

Temporary Group Address

The radio supports the temporary group address assigned by the SwMI. The address is valid only for the lifetime of the call.

The radio monitors signaling addressed to the temporary group, when the radio initiates a group call on the selected group, and the SwMI assigns the call to a temporary group.

The radio supports assignment of an incoming group call to a temporary group address.

2.8.24

Late Entry

A radio can join a group call even if it does not participate in it from the beginning.

For example, if you turn on your TETRA terminal and select a talkgroup with an ongoing group call, the radio automatically joins the call. Similarly, if the radio has been outside of the radio coverage, for example in a tunnel, the control channel continues to divert the terminal to a talkgroup call, assuming a call is already in progress.



NOTICE: For Trunked Mode Operation (TMO), this feature must be configured on SwMI. Acknowledged late entry and late entry paging are not supported.

2.8.25

User Initiated Group Attachment

A radio must attach itself to a talkgroup to participate in a group call.

The radio initiates a group attachment request to the SwMI during the following conditions:

- Radio powers up.
- Radio registers on a new site.
- User initiates a group change.
- User activates a scan list.

When a group change is requested, the radio initiates an attachment to the SwMI, detaching the old group and attaching to the new one.

All group attachments sent by the radio are sent with attachment mode of **Amendment** or **Detach all...** depending on which form causes sending fewer bits over the air interface.

When you turn on scanning and then select the scan list, the radio sends a group attachment request to attach the scan groups in addition to the selected group. Similarly, when you select an Announcement Talkgroup (ATG), the radio sends an attachment of the ATG as the selected group along with the attachment of the associated groups as scan groups. If a group associated with an ATG is selected, the radio sends an attachment of the ATG as the selected group and as a scan group.

The TETRA TIP provides a facility by which the radio can send a status message to the SwMI to turn scanning off and on to save air interface signaling.

If the radio is provisioned with this option, when you turn scanning off, the radio sends an appropriate TETRA signaling. In this state, the radio does not monitor any groups other than the selected group. If you then turn scanning on, the radio sends an appropriate TETRA signaling and begins monitoring all scanned groups again.

If the radio is not provisioned with this option, you can only deselect the active scan list. However, you cannot turn off the scanning. Deselection of the user scan list causes a group detachment of the scan list groups sent to the SwMI. However, the radio continues to scan all other groups, such as ATG associations.

2.9

Private Call

The Private Call, also called point-to-point, or individual call, enables calling between two individuals. No other radio can hear the conversation.

This call type can be carried out in two ways:

- Duplex call (if the system allows), in Trunked Mode Operation (TMO) Mode. Both parties can speak at the same time.
- Simplex call, in TMO or Direct Mode Operation (DMO) Mode. Only one party can speak at a time.

From your radio, a Private Call can be started using one of the following methods:

- By pressing predefined One-Touch Button.
- By selecting a contact from the address book.
- Dialing the Individual Short Subscriber Identity (ISSI) or Individual TETRA Subscriber Identity (ITSI) number on the idle screen.
- By selecting the ISSI or ITSI number from the recent call list.
- Using Remote Control feature.
- Other.

When a DMO Private Call takes place, radios not involved in this call receive the channel busy indication. The radios are identified using their radio numbers.

2.9.1

Simplex Private Call

The radio is able to make and receive private calls to and from other TETRA radios with simplex speech capability. This call type uses TETRA individual call signaling.

All private calls are initiated using the on-off hook method. For incoming calls, the radio accepts both direct and on-off hook setup.

2.9.2

Duplex Private Call

The radio allows making and receiving private calls to and from other TETRA radios with duplex speech capability. Depending on the configuration, the radio may prohibit you from initiating duplex private calls.

The radio always initiates duplex private calls using on-off hook signaling with the traffic channel allocated by the SwMI only after the called party has answered the call. Therefore, the radio generates all progress tones during the call setup. In addition, the radio allows the SwMI to modify the call setup to direct. This modification enables the infrastructure to generate the progress tones.

2.9.3

Transmission Timeout Timer

In a simplex call, the radio limits the time you can continuously talk in a group call without interruption, according to a provisioned value. You are warned a short time before the talk time expires. The timer is provisioned per talkgroup folder.

2.9.4

Call Restoration in Private Call

If the radio roams while you are the transmitting party in a private call, the announced cell reselection is employed (if possible). Call restoration procedures are performed in the new cell.

If you are not the transmitting party, the radio employs an unannounced cell reselection, followed by the call restoration procedures.

2.9.5

Assistance Call

Assistance Call feature helps you to call for assistance during normal and non-critical situations. Starting an Assistance Call means starting a private call on a configured ISSI number. Assistance Call destination address and priority can be configured in the codeplug. This feature is only supported in TMO mode and on GMOI network.

Assistance Call can be a simplex or duplex call depending upon your service provider settings. An Assistance Call is full-duplex when you start the call using radio menu. When you type the number and press PTT, then your radio starts a half-duplex call, but if you type the number and press SEND, then the call is duplex.

2.9.6

DMO Individual Call Presence Check

If the other party is listening, the Presence Check feature allows the user making a Direct Mode Operation (DMO) private call to have a confirmation. This confirmation is important in situations where it is crucial that the message gets through.

If the other party does not answer the call, a radio with Presence Check enabled displays the `Party not available` message. Both radios must support this feature to use it.

In addition, radios can be configured to Accept DMO Individual Calls with Presence Check. If enabled, the radio accepts incoming calls with or without the presence check. If disabled, the radio only accepts private calls without the presence check.

2.9.7

DMO Individual Only Talkgroups

It is possible to configure some or all Direct Mode Operation (DMO) talkgroups to allow only individual calls. This configuration helps optimize frequency allocation in DMO.

2.9.8

Private Calls through DMO Gateway

Private Calls through Direct Mode Operation (DMO) Gateway is a paid feature.

The DMO Gateway can relay clear and non-BSI encrypted private calls from a radio in Trunked Mode Operation (TMO) to another radio in DMO, and the other way around.

A DMO radio can directly establish a private call with another TMO radio through its Individual Short Subscriber Identity (ISSI).

A TMO radio initiating a private call with another DMO radio first establishes a private call with a DMO Gateway. Then the DMO Gateway establishes a private call with the target address of the DMO radio, which is already predefined in the Gateway. The DMO forwarding address is configurable using Customer Programming Software (CPS), Integrated Terminal Management (iTM), Gateway MMI, or remotely using AT commands or TMO SDS Remote Control.

2.10

Phone Call

The phone call service enables a radio in Trunked Mode Operation (TMO) to communicate in a one-on-one simplex or duplex conversation with a phone (for example, a phone call-enabled TETRA radio or landline number) using a telephone switch. The radio supports individual call service to an external identity.

Two phone call types are available:

- a full phone number Public Switched Telephone Network (PSTN) call is addressed to the defined PSTN gateway address.
- an internal Private Automatic Branch Exchange (PABX) call is addressed to the defined PABX gateway address.



NOTICE: The PSTN phone call is supported when PSTN/PABX feature is enabled in the codeplug and the SwMI supports this functionality. The PSTN/PABX gateway must be configured properly.

No more than one PSTN/PABX gateway ID and one PABX/PABX gateway ID are available in the radio.

2.10.1

Phone Call Initiation

The radio is able to initiate phone calls to a Public Switched Telephone Network (PSTN) or Private Automatic Branch Exchange (PABX) with duplex speech capability. This call type uses TETRA individual call signaling using single stage dialing and hook setup for outgoing calls.

Using the hook signaling for phone calls, implies that until a traffic channel is allocated, the radio generates all feedback tones internally. In addition, the radio accepts SwMI modification of the call setup to direct, enabling the infrastructure to generate the progress tones.

Phone calls can also be made between TETRA radios using the Mobile Station International Subscriber Directory Number (MSISDN) number as the called party number. MSISDN calls share the same gateway as phone calls, that is, PSTN gateway configured in the codeplug. If an MSISDN call is placed, two radios can have a simplex or duplex call based on the assigned ISDN number.



NOTICE: The Dimetra Infrastructure does not support private calls and Short Data Service (SDS) through MSISDN.

2.10.2

Phone Call Reception

Incoming phone calls, from the land gateway to mobile, use on-off hook signaling. The radio extracts the gateway ID from the call setup signaling, to determine whether to start phone or Private Automatic Branch Exchange (PABX) call.

2.10.3

Call Restoration in Phone Call

If the radio roams while being in an active phone call, and the announced cell reselection is possible, then the announced cell reselection is employed. Also the call restoration procedures are performed.

2.11

Emergency Operations

Emergency Operations are used in critical situations.

Pressing the **Emergency** button or entering Emergency number and pressing the **Send** key, activates one or more services, depending on the service provider setting:

- Sending Emergency Alarm
- Sending Short Data Service (SDS) Status
- Starting Hot Microphone operation
- Starting Silent Emergency
- Starting Emergency Individual Call (Private or MSISDN)
- Sending the GPS/GNSS location information



NOTICE: It is possible to power up the radio by pressing the Emergency Button. Depending on the service provider settings, the radio can start Emergency Operations automatically. If the radio is PIN-protected, except for SIM PIN, Emergency Operations bypass the PIN lock during the Emergency Operations.

During Emergency Operations, the radio automatically rejects phone, Private Automatic Branch Exchange (PABX), and private calls, and does not monitor the talkgroups in the selected scan list. However, if an Announcement Talkgroup (ATG) is the selected group, the radio monitors the sub-groups associated with the ATG.

When entering Emergency Operation, any ongoing voice call is aborted or cleared down. Any packet data transfer in progress is aborted. However, the session is kept open.

2.11.1

Emergency Group Call

The Emergency Group Call has the highest communication priority that means it is the pre-emptive call. Emergency Group Call is available in both Trunked Mode Operation (TMO) and Direct Mode Operation (DMO) modes.

During Emergency Operations, Emergency Group Call can be started by pressing **PTT**. The radio may also support Hot Microphone operation, which allows the Emergency Call to be conducted without pressing **PTT**. If a radio receives an incoming group call with emergency priority, the display shows that an emergency call has been received, and a special audio alert is played.

The Emergency Group Call Termination feature allows the radio user to attempt terminating an Emergency Group Call by pressing the **End** key. The ownership status of the radio determines the following termination conditions:

Call Owner

The radio sends a disconnection PDU to the SwMI. The SwMI responds by sending a release PDU response with an indication that the call has been disconnected.

Non-Call Owner

If a radio is programmed to terminate a call, the termination procedure is the same as for the call owner in an Emergency Group Call. Otherwise, the radio leaves the group call without informing the SwMI.

The SwMI may reject the termination request, in which case the radio stays in the group call.

An emergency group call can be configured as non-tactical or tactical:

- A non-tactical call is initiated on a talkgroup designated by the codeplug setting. When in non-tactical emergency mode, you cannot switch talkgroups.
- A tactical call is initiated on the currently selected talkgroup.

In TMO, if the radio enters emergency operations while the emergency broadcast call is active the radio continues on the call without initiating any calls and sends an emergency alarm.

2.11.2

Non-Tactical Emergency

In Non-Tactical Emergency, the radio switches to a designated Emergency talkgroup when starting Emergency Operations. This talkgroup is used for the complete duration of the Emergency Operations and changing talkgroup is not allowed.

In Trunked Mode Operation (TMO), it is possible to configure the radio to make Emergency Non-Tactical Group Calls without sending attachment. If set, the radio assumes implicit attachment after receiving a temporary address.

In Direct Mode Operation (DMO), the Non-Tactical Emergency proceeds on the same frequency as the previously selected talkgroup. The service provider can designate any Individual TETRA Subscriber Identity (ITSI) address to be used for Emergency Operations and this ITSI can be an Open Group - broadcast address.

After exiting from Non-Tactical Emergency, the radio goes back to the previously selected talkgroup.

2.11.3

Emergency Individual Calls (Private or MSISDN)

The Emergency Individual Calls are Simplex or Duplex Calls with emergency priority. On pressing the **Emergency** button, the radio initiates an Individual Call to the provisioned address (private or MSISDN). During this kind of call, all user indications are unavailable and all other services are rejected. Emergency Operation ends when the Emergency Individual Call is ended.

2.11.4

Emergency Alarm

The emergency alarm is a special status message sent to the infrastructure while starting the Emergency Operations. The radio may wait for infrastructure acknowledgment for this alarm and attempts retries.

Each time the radio enters the Emergency Operation, it sends an emergency alarm. When an emergency alarm is sent successfully, the respective audible tone sounds.

In addition, once the radio is in Emergency Operation and on pressing the **Emergency** button, an extra emergency alarm is sent. The only exception of this condition is during Hot Microphone transmission.

The message can be dispatched both in Trunked Mode Operation (TMO) and Direct Mode Operation (DMO).

2.11.5

Emergency SDS Status

Emergency Short Data Service (SDS) Status allows the radio to send a status message with a pre-programmed value to the destination address set up in the codeplug.

This feature is available in Trunked Mode Operation (TMO) only. If no status acknowledgment or negative acknowledgment is received, the radio retries sending the message. If Emergency Alarm or Hot Microphone is configured, status is not sent.

2.11.6

Emergency Hot Microphone

The Hot Microphone allows you to talk without pressing the **PTT** button during Emergency Operation. The transmission continues for a provisioned amount of time. Pressing the **PTT** button before the Hot Microphone time expires ends the Hot Microphone operation. Then normal PTT operation in Emergency group call takes over whereby the transmission is ongoing for the time the **PTT** button is held.

Subsequent **Emergency** button presses during the Emergency Operation restart the Hot Microphone transmission.

If a talk permit is granted to another member of the group, the Emergency Call received tone is played. If configured, the radio automatically attempts to get talk permit again.

Pressing **End** soft key or **End** key ends the Hot Microphone operation.

2.11.7

Alternating Hot Microphone

The Alternating Hot Microphone is an enhancement of the Hot Microphone feature. It allows you to have the Hot Microphone switched on and off alternately.

If this feature is enabled, you can initiate the Alternating Hot Microphone by pressing the **Emergency** button.

The Alternating Hot Microphone terminates when one of the following conditions is met:

- The radio exits the Emergency Mode.
- The Alternating Hot Microphone timer expires.
- The **PTT** button is pressed.
- The right **Soft** key is pressed (only during the transmission timeslot).

To skip your transmission timeslot and jump to a receiving timeslot, press the **End** key.



NOTICE:

When the radio goes out of the service, it enters the receiving mode and the Alternating Hot Microphone is on hold. When the radio is back to the service, the Hot Microphone transmission and the Alternating Hot Microphone resume.

When the radio is in the Emergency Mode, pressing the **Emergency** button restarts the Alternating Hot Microphone.

2.11.8

Silent Emergency Mode

The Silent Emergency Mode is a type of emergency services that provides no audible indications nor keypad tones at the entrance. All the display indications are as in the home mode. However, the radio cannot use any services except for:

- Receiving Ambience Listening
- Sending Silent Emergency Alarms
- Sending GPS location reports



NOTICE: If you try to activate any other feature, it is blocked.

If the Silent Emergency feature is enabled, the radio enters Silent Emergency Mode on pressing the **Emergency** button. After entering this Mode the radio stays in TMO or switches to it, depending on the actual state. Once in TMO, the radio sends Silent Emergency Alarm.



NOTICE: If the radio is in a private or group call, the radio waits until the call ends and then enters the Silent Emergency Mode.

The radio keeps re-sending the alarm until successful sending is confirmed. After the alarm is successfully delivered, the radio stays in Silent Emergency Mode and waits for the Ambience Listening.

Your radio exits the Silent Emergency Mode, under the following conditions:

- Press **Menu** and then **#** key within 3 seconds.
- No success in sending the Silent Emergency Alarm and the maximum number of retries has been reached.
- The control room terminates the Silent Ambience Listening.
- The Ambience Listening is disconnected due to another reason.

If you turn off the radio in the Silent Emergency Mode, the radio switches to pseudo power off state. In this state, the radio appears to be turned off. However, the radio is still on and in the Silent Emergency Mode. On turning the radio on during the pseudo power off state, the radio acts as during turning on and still is in the Silent Emergency Mode.

2.11.9

Invisible Emergency

It is possible for the service provider to disable visual and audible indications when performing Emergency Operation on the radio, known as Invisible Emergency. Invisible Emergency provides an extra layer of safety when using Emergency Operation in a critical situation, for example during a direct attack on the user.

2.11.10

Disaster Alert

Disaster Alert call is a broadcast emergency call initiated by the radio, with emergency pre-emptive priority that everyone in a broadcast area can hear. This feature is designed for catastrophic situations, such as earthquakes, and has the highest priority over other calls. All radios under Disaster Alert display emergency notification on their screens. The alert message, its duration, and destination talkgroup can be configured in the codeplug.

To initiate Disaster Alert, switch the radio to Disaster Alert mode and press **PTT** button. When the call ends, the radio exits the Disaster Alert state.

During Disaster Alert, other functionality is impacted:

- When Disaster Alert begins, any other ongoing services are terminated.
- No other services can interrupt this type of call.
- Hot Mic functionality cannot be used.
- Speech can only be in Clear mode, even if any of the encryption services are enabled. The only exception is E2E Encryption.



NOTICE: Not all infrastructures support this feature. Consult service provider before enabling this feature.

2.12

Short Data Services

The radio supports the following Short Data Service (SDS) message types:

- SDS Status.
- SDS User Defined Data Types 1, 2, 3.
- SDS User Defined Data Type 4 with or without SDS Transport Layer (SDS - TL).

The feature supports the following addressing modes:

- Radio to radio.
- Radio to talkgroup.
- Radio to external subscriber number (gateway address).



NOTICE: For SDS - TL, the message can be sent through the service center.

The radio provides a short data bearer service for both internal and external applications.

The radio supports SDS - TL services which provide end-to-end acknowledgments, delivery report requests, and message numbering for SDS user-defined data type 4 messages. The TL also provides SDS access for applications that do not request these transport layer services, however, use a Protocol Identifier (PI). The radio can send the delivery report by using an appropriate TETRA signaling, even if the originator requested a short report. The radio can support the old SDS - TL standard for operation on legacy systems, or for operation on other SwMIs.

An externally connected device may access the SDS services in the radio using AT commands and TNP1 protocol. An external application may use this service to send and receive SDS statuses, SDS user-defined data types 1, 2, 3, and 4.

Downlink SDS messages type 4 are presumed to contain a PI for identifying the target application. If an external application has registered with the radio for that PI, the radio delivers the message to the target application. The radio may receive downlink SDS messages that are successive retransmissions of a message already received and acknowledged by the radio. The radio does not display these messages, nor store in them in the inbox, nor send them to an external application.

2.12.1

Status Messages

You can select from a list of up to 400 preprogrammed alphanumeric aliases each of which corresponds to a status value. The valid range of uplink status values is a set of provisioned parameters. If the radio is not enabled with targeted status, the status value is sent over the air interface to the address of the selected group. The radio recognizes the general status acknowledgment sent from the Switching and Management Infrastructure (SwMI) and the negative acknowledgment. In Trunked Mode Operation (TMO), if no status acknowledgment or negative acknowledgment is received, the radio retries sending the message. The number of retries and time to wait before retrying are provisioned parameters. You are notified of the delivery status. As there is no

acknowledgment for Direct Mode Operation (DMO) status messages, you are notified only of sending the status message. The radio does not initiate sending of status messages on a traffic channel.

If the radio is provisioned with the targeted status, the status value is sent over the air interface by default to the last sent target. You have also an option to specify a different individual or group to send the message to. In other words, you can send a Short Data Service (SDS) status message to a directly entered ID (for example, ISSI, GSSI, MSISDN). If the radio is not provisioned with the targeted status and you want to send an SDS status message, the following possible actions apply:

- When the default address type of the targeted SDS status is set to **Private** or **Phone**, the default address is used as ISSI, ITSI, GSSI, or ISDN, depending on the configuration.
- When the default address type of the targeted SDS status is set to group, the selected talkgroup address is used.
- When the targeted SDS status is set to **Dynamic**, the status message is sent to the address configured for the Dynamic statuses, or defined by a dispatcher (by SDS Remote Control).

The radio accepts status messages from addresses it is monitoring. The radio can be preprogrammed with an appropriate text associated with each status value. The radio notifies when a new status message has been received. Upon receiving an incoming status message, the stored text corresponding to the status value is extracted and placed in the text message buffer as a text message. Receiving a status causes the radio to display the message mail screen, which allows you quick access to read the message. A received status can be stored in the radio text message buffer.

The PEI provides access for external applications to send and receive status messages.



NOTICE: The Dimetra Infrastructure does not support the targeted status feature.

2.12.2

Shadow Groups (Address Bundle)

Shadow Groups (Address Bundle) is a paid feature and it is not available on Gateway mode.

The Shadow Groups feature offers a way of sending statuses to multiple destinations or recipients simultaneously. Each radio can store up to 255 Address Bundles.

Four types of Address Bundles are supported:

- Status Addressing (including emergency alarm)
- GNSS/GPS LIP Addressing
- RMS/FMS Addressing
- Bluetooth Sensor Addressing

Shadow Groups in TMO

Each Address Bundle may contain up to four target addresses (ISSI or GSSI). Each talkgroup may be configured to send statuses, GNSS/GPS LIP reports or RMS/FMS messages to a specific Address Bundle.

Additional Address

The Additional Address feature allows the radio to send RMS messages, and Local Information Protocol (LIP) reports to additionally defined recipients.

Your service provider defines the default addresses where the radio sends RMS messages and LIP reports. If an Additional Address is selected and enabled, RMS messages and LIP reports are also sent to the recipient defined in the Additional Address.

You can create, edit, and delete Additional Addresses using the radio menu. If your service provider configures an Additional Address, the service provider can disable edition and deletion of the address using the radio menu.

You can define up to 30 Additional Addresses.

Shadow Groups in DMO

In DMO the Address Bundle contains one target address (ISSI or GSSI). Each talk group may be configured to send statuses or GNSS/GPS LIP reports to a specific Address Bundle.

The Shadow Groups feature may affect Emergency Calls setup time to be slightly elongated.

2.12.3

Text Messages

The radio supports an internal text messaging application using the TETRA Short Data Service Transport Layer (SDS - TL). The maximum lengths allowed for encoded messages are 160 characters for a 7-bit encoding scheme, 140 characters for an 8-bit encoding scheme, and 70 characters for a 16-bit encoding scheme.

Table 4: Maximum SDS Lengths with Encryptions

Encoding Scheme	Without OPTA and E2EE	With OPTA and without E2EE	Without OPTA and with E2EE ¹	With OPTA and E2EE ¹
7-bit	160	136	124 (121)	100 (97)
8-bit	140	116	109 (106)	85 (82)
16-bit	70	46	54 (53)	30 (29)

Depending on radio settings, for each message in the **Inbox**, the following options are available:

- **Store** – used to save the message as a template.
- **Delete** – used to remove the message from the list.
- **Delete All** – used to remove all the messages from the list.
- **Reply** – used to send a reply to the message originator with the option to edit the text (where available).
- **Forward** – used to send the current message to another recipient with the option to edit the text.
- **Refresh** – used to reorder the messages list and see the newest at the top. When you are in the **Inbox** and the new message comes, refresh the list to see the new message.

The radio provides an edit facility for composing and editing a text message. The message can be sent to a target TETRA radio using Short Subscriber Identity (SSI) addressing, and is sent with a request for a received delivery report.

All the outgoing text messages (short or long) are stored in **Outbox**, when the store and forward mechanism is not in place. When the store and forward feature is enabled and the messages go through the store and forward server, the short messages are stored regardless the delivery status. Whereas, long messages are stored only if delivered (even if only to the store and forward server). Depending on radio settings, for each **Outbox** message the following options are available.

- **Store** – used to save the message as a template.
- **Delete** – used to remove the message from the list.
- **Delete All** – used to remove all the messages from the list.
- **Resend** – used to edit the text and resend the message to the same recipients.
- **Forward** – used to send the message to the other recipient with the option to edit the text.

¹ In E2EE SDS, a timestamp reduces the maximum size of the user data. See values in parentheses.

- **Refresh** – used to reorder the messages list and see the newest at the top.
- **Delivery Status** – used to check the time and the date when a message was sent, delivered, read, expired, or not delivered. Every status change is communicated.

Delivery report is saved in the **Inbox** and in the associated message in **Outbox**. However, the report is deleted from the **Inbox** after viewing it.

Outbox and **Inbox** share memory area, hence their capacity depends on the combination of stored short and long messages in each of these folders. If **Inbox** is empty, **Outbox** may store up to 100 short messages or at least 20 full-size long messages. If **Outbox** is empty, **Inbox** may store up to 100 short messages or at least 10 full-size long messages. When you enter the **Messages** sub-menu, the number on the right side of **Inbox** and **Outbox** is indicating the number of the messages stored. If the **Outbox** is empty, then the radio displays **No Messages** notification.

2.12.3.1

Buffer Full Overwrite Policy

Upon receiving a text message, the radio places the text into a circular buffer. You are notified when a new text message is received and a quick access to read the message is provided. If a delivery report is requested, the radio sends it upon receipt of the message by SDSTL. If a consumed report is requested, the radio sends it when you read the message.



NOTICE: If you read the message when the radio is out of service, the report may not be sent.

You can save incoming or edited (outgoing) text messages. These messages can be edited and sent.

For each message, you can verify its timestamp. The timestamp displayed is extracted from the SDS TL PDU. The timestamp is generated and inserted to the message by the SwMI.

2.12.3.2

SDS Messages Concatenation

This feature allows sending long text messages up to 1000 characters. All the messages that are longer than 140 characters are divided and sent separately one after another. When a recipient receives all the parts of the message, it displays as one on the screen.

When the radio receives an SDS message and the **Inbox/Outbox** is full, the radio acts according to the **Buffer Full, Overwrite Policy** codeplug field settings.

When the text or status message is received and accepted, the radio retrieves actual time information from its internal clock.

The radio can reconstruct a long text message consisting of up to ten short messages. The maximum length of the message is 141-1000, what can be defined in the codeplug. The radio recombines the text segments independently of the order they have been received to the correct order of the original message. The message can be combined only if all their message reference number are correct and the segmented receiver timer is still valid.

You can send long text messages to an individual destination. However, sending long text messages to groups is not possible:

- Receiving the message during a group or broadcast call — radio allows receipt of the text message during ongoing group call and broadcast call. The group/broadcast call is displayed with the **New mail arrived** icon and tone for mail received played.
- Emergency Mode — you can receive SDS messages. To read the SDS messages the radio have to leave the emergency mode. Sending the SDS messages in the emergency mode is prohibited.

2.12.4

Immediate Text Messages

Immediate Text Messaging is a paid feature.

The Immediate Text Messaging feature enables the radio to receive and display text messages immediately. This feature is used for sending high important information from the console to radios.

The following occurs when the radio receives an immediate text message:

- the immediate text message is stored in the **Inbox**.
- the content of the immediate text message is displayed.
- the relevant audio tone is played.
- also, if the periodic alert feature is enabled, the periodic alerting is active until you press the **Soft** key.



NOTICE: If this feature is disabled, the immediate text messages are processed as normal text messages.

When you reply or forward an immediate text message, the message is sent as a normal text message.

When the radio receives more than one immediate text message, the latest received immediate text message is displayed. All previous immediate text messages in the **Inbox** are not prompted.

2.12.5

Home Display Text Message

Your radio is provided with a feature that allows your service provider to send special text messages to the display. The message stays on the home screen until a new message is received. Power cycle your radio to replace the Home Display message to the predefined one.

2.12.6

Predefined Templates (ATS Entry Prompt)

This feature assists the radio in sending formatted messages with a predefined destination address (MSISDN, SSI, or TSI) for computer applications.

You can select a predefined entry prompt which defines a message format to help with the construction of a Short Data Service (SDS) message. The prompt definition is set in the codeplug. The definition sets areas that are read-only, areas that can be edited, and the type of characters that can be entered (numeric, alpha-numeric, or phone digits). Along with the message definition, the address to send the message is provided.

When you send the message, it is sent using SDS Transport Layer with the PI that is provisioned in the codeplug. A receipt report is requested.

The radio chains multiple predefined templates with the same Prompt ID into a single multifield template. The Predefined menu can store predefined and multifield templates. There is no indication to distinguish between the two, although an alternative solution is to define the template name which is displayed as the title of the template. However, this solution is subject to user configuration.

2.12.7

SDS Air Interface Aspects

The types of delivery reports available are standard report and short form report. The radio can be provisioned to send a short-form SDS - TL receive report when the originator of the message allows short-form report. The short form report uses a specially designated 16-bit SDS status value instead of

SDS-REPORT. The radio can respond to a delivery response request automatically or manually although selection of report types through radio MMI is available only in manual response.

The radio supports SwMIs that employ store and forward service as indicated in the cell broadcast information. The radio supports use of a service center, which address is set in the radio. The store and forward operation is supported. However, the radio notifies you only on successful sending of the message. The radio does not wait for the report from the service center.

Downlink SDS messages types 1, 2, and 3 are always routed to the PEI when an AT application is registered. If no external application is registered, the message is discarded.



NOTICE: The DMO SDS does not support type 1,2, and 3 user-defined short messages.

2.12.8

SDS Encryption

Short data messages stored in a radio are protected against any unauthorized access. The stored data includes messages in the **Inbox**, **Outbox**, and stored call out messages.

The required protection against any unauthorized access through the MMI, PEI, or unintentional access by other means is carried out through the special mechanisms. The encryption of stored messages preventing from accessing the memory directly and the user authentication protect SDS messages. Protected messages cannot be read on the radio MMI unless valid authentication occurs. For the user authentication, the existing radio PIN is used.

SDS messages received by the radio are encrypted before being stored in the **Inbox**. Store and Forward messages are encrypted before being saved in the **Outbox**.

Received call out messages are encrypted before being stored in the **CO Box**.

If the feature is enabled, then the radio prompts you to enter the PIN if any of the following menu items are selected from the MMI.

- **Messages** → **Inbox**.
- **Messages** → **Outbox**.
- **Messages** → **CO Box**.

Following successful PIN entry and access to the required messages, the radio does not require further PIN entries to access messages unless one of the following conditions has been met.

- Exiting from the radio menu.
- Turning off the radio.
- Changing the PIN from the MMI.

If you disable the PIN lock through the MMI or change the PIN, the protected messages are deleted. Before deleting the messages, you are prompted to ensure that the operation should proceed. If the PIN lock is changed through the PEI, all the protected messages stored in the **Inbox**, **Outbox**, and **CO Box** are deleted. On enabling the radio permanent disable, the access to the protected messages is lost.

2.12.8.1

SDS End-to-End Encryption

End-to-end Encryption (E2EE) is a paid feature which provides customers with a higher degree of confidentiality than existing TETRA air interface data encryption.

The TETRA standard supports the air interface security that provides protection of the air interface. The information flow inside the infrastructure is not secured. When you require data protection for your data going through the infrastructure, you need your entire transport path to be encrypted.

This entire path encryption is called E2EE. The source and the destinations are supplied with the mechanism for encrypting and decrypting.

 **NOTICE:** The 260–275 MHz radios do not support the SDS end-to-end encryption.

In air interface encryption, the receiving Base Station decrypts data which travels clear within the system domain. For E2EE, the transmitting radio encrypts the data and the receiving radio or an E2E terminator located in the infrastructure decrypts the data.

E2EE protects the SDS/SDS-TL data services both in TMO and DMO. The following TETRA data types are protected.

- SDS type 4 with SDS - TL.
- SDS type 4 without TL.

For short data applications, the source data may come from an external application or from a task internal to the radio, such as text messages or GPS. The radio passes only the internal text messages and GPS data for encryption by its crypto-engine.

The encrypted short data service is established between two end points. One end point is terminated in the radio, and the other end point is terminated in a Short Data Encryption Gateway (SDEG) or another radio. The destination address specifies the encryption type, that is, whether the packets are transmitted as encrypted, clear or dropped.

Figure 5: SDS End-to-End Encryption

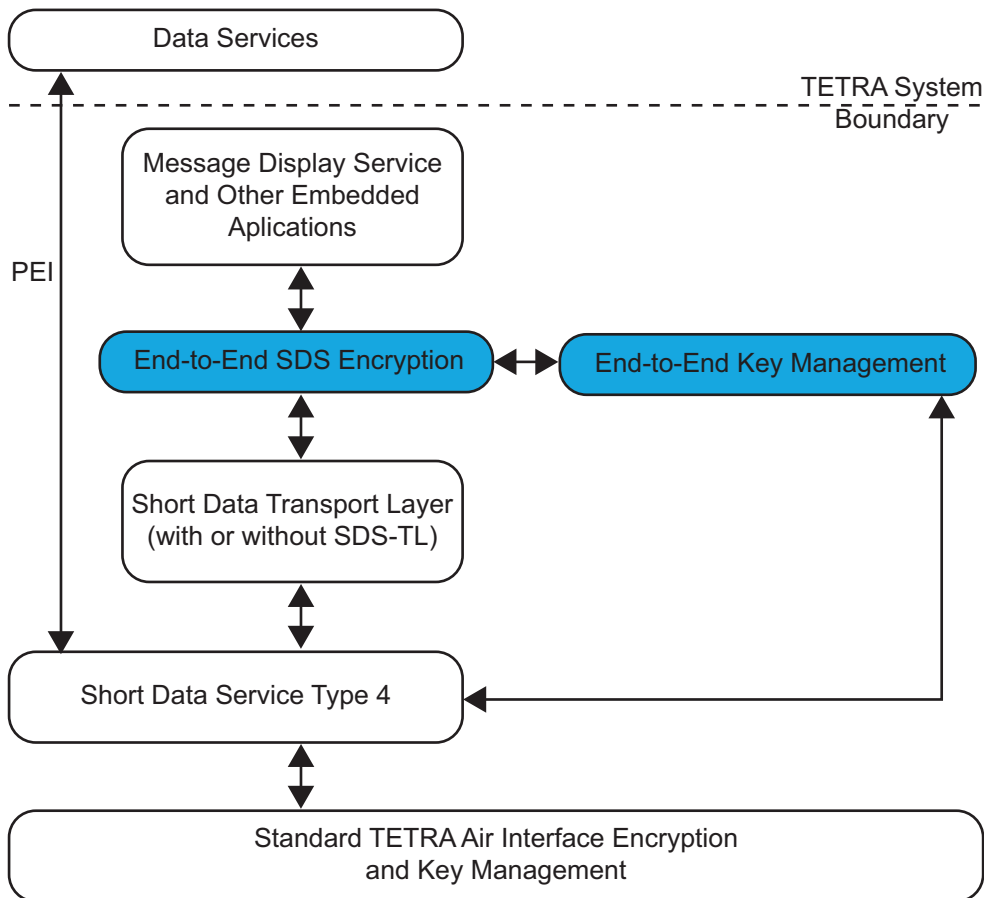

 **NOTICE:** Key Management Facility (KMF) can manage and support only one short data association and a key at the same time.

The radio selects the E2EE mode for the outgoing text message in accordance to the address association and requirements for the E2EE High Security Mode. Depending on codeplug settings, you can override the address association and select using the MMI menu whether an SDS is sent to clear or encrypted contact (Group or Private Number).

The radios support the high security mode configurable using the CPS. In this mode, the association that binds the address to a given cryptogroup is always mandatory.

If no cryptogroup associations exist, this condition means that the keys are not loaded. In such situation, the radio discards any outgoing or incoming message that is encrypted. You are alerted when this situation occurs.

This feature can only be disabled using the KVL.

2.12.9

Store and Forward

This feature allows communicating with each other without being available at the same time. If the destination is not reachable, the message is stored in the system (if supported) until it is available or the expiration time is exceeded. The system is configured to delete the message after a preconfigured time and this time cannot be configured using the radio.

You can send the store and forward messages to an individual address or a group. Depending on the codeplug settings, if you choose to send it to the group, the message status is switched from **Store and Forward** to **Immediate**.

When the **Sending group message to Store and Forward Server** is enabled, an SDS message sent to a group is conveyed with assistance of the store and forward service. The radio sends Store and Forward SDS to group only with Delivery Report Request set to **None** by the service provider. For Store and Forward SDS to an individual address, the radio can send SDS with any Delivery Report Request (None, Received, Consumed, Received and Consumed) the user set (via MMI or via codeplug settings). The radio does not request a delivery report, thus you are not notified of the delivery status.



NOTICE: Verify whether the infrastructure system supports this functionality.

2.12.10

SDS Receive Failure Notification

When a radio fails to decrypt a received SDS message, it displays a notification including the ISSI of sender and reason for failure.

2.13

Security Services

The radio provides TETRA security features as described in the TETRA Security ETS 300 392-7 standard, TTR 001-11 TIP, and TTR 001-13 TIP.

2.13.1

Terminal Equipment Identity

The Terminal Equipment Identity (TEI) is unique identification number programmed in the radio at the factory and cannot be later modified.

2.13.2

PIN/PUK User Authentication

In order to authenticate yourself, the radio supports a Personal Identification Number (PIN) and PIN Unblocking Key (PUK) mechanisms. These mechanisms prevent unauthorized access to the radio. The PIN/PUK operations are available from both MMI and PEI (using AT commands).

For the authentication purpose, the radio prompts you to enter a valid 4-digit PIN, before the radio allows you to access all the available services. The PIN is defined in the codeplug.

If the maximum number of consecutive failed attempts is reached, the radio is blocked and remains in this state until it is unblocked. The permissible number of consecutive failed attempts is defined in the codeplug. The blocked status is sustained regardless of turning off or battery removal.

When the radio is PIN locked, you have no or limited access to the radio services. The PIN is defined in the codeplug. The radio is unblocked either by entering the PUK or by using the CPS. The PUK can be entered through the MMI or through the PEI. The PUK is defined in the codeplug.

2.13.3

Authentication

Authentication establishes a level of a trust between a radio and SwMI. It is a challenge-response result protocol between two parties based on their common knowledge of a secret key (K) to verify the identity of each party.

The SwMI Authentication Centre (AuC) provides a single K for authentication, which is shared only with the radio. The SwMI always initiates Authentication. If set by the service provider, the radio can also authenticate the SwMI.

2.13.4

Air Interface Encryption

Enhanced Security, which consists of Trunked Mode Operation (TMO) Air Interface Encryption class 3G and DMO class 2, is a paid feature.

The radio supports TETRA Air Interface Encryption (AIE) using the standard TETRA public encryption algorithms, as defined in TETRA Security ETS 300 392-7, TEA1, TEA2, and TEA3. The focus of cryptography in TETRA is the encryption key. TETRA AIE provides 12 000 000 000 000 000 000 000 key combinations.

TETRA TMO has three classes of encryption:

- Class 1 – clear (none).
- Class 2 – static key encryption (SCK).
- Class 3 – derived key encryption (DCK, sometimes called the dynamic key), the Common Cipher Key (CCK), and the Group Cipher Key (GCK).

TETRA Direct Mode Operation (DMO) has two classes of encryption: Class 1 and Class 2.

The security features supported in the radio depend on the security mode.

Table 5: Security Features Required Per Security Class

Security Feature	Mode			
	Security Class 1	Security Class 2	Security Class 3	Security Class 3G
Radio Initiated Authentication	Not Allowed	Not Allowed	Not Allowed	Not Allowed
SwMI Initiated Authentication	Optional	Optional	Mandatory	Mandatory

Security Feature	Mode			
	Security Class 1	Security Class 2	Security Class 3	Security Class 3G
Mutual Authentication	Optional	Optional	Optional	Optional
Over-the-Air Rekeying (OTAR)	N/A	Optional	Mandatory	Mandatory
SCK AIE	N/A	Mandatory	N/A	N/A
DCK AIE	N/A	N/A	Mandatory	Mandatory
GCK AIE	N/A	N/A	N/A	Mandatory



NOTICE: In the current release, the radio does not support the following security features:

- Radio initiated authentication.
- Support for TEA4.
- Explicit authentication during Dynamic Group Number Assignment (DGNA).
- OTAR in foreign network.
- GCK AIE in foreign network.

2.13.4.1

Clear Radios (Class 1)

A radio can be configured as a clear radio. In such case, the radio identifies itself in registration as a Security Class 1 radio and does not support encryption. A Security Class 1 radio does not contain any encryption algorithms in its software.

2.13.4.2

Static Cipher Key Encryption (Class 2)

The radio supports static AIE using a set of up to 32 static cipher keys (SCK) shared by the SwMI and all authorized radios. The radio then determines which static keys to use based on the SCK Number (SCKN) and SCK version number (SCK-VN) broadcast by the SwMI.

A radio can be configured to support static key encryption. In such case, it identifies itself in registration as a Security Class 2 radio, and attempts to negotiate Security Class 2 encryption. Each radio then uses either the TEA1 or the TEA2 (TEA 3 — for Asia and Pacific) Key Stream Generator (KSG) algorithm. Each radio contains only one of those algorithms in its software.

When Security Class 2 Encryption has been negotiated, encrypted PDUs are encrypted using SCK.

In DMO, the system manager may choose the SCK and the key may be distributed from the TMO SwMI using the OTAR mechanism or provided manually using KVL.

2.13.4.3

Derived Cipher Key and Common Cipher Keys Encryption (Class 3)

DCK/CCK are required to prevent over-exposure of key material. Existing encryption systems use Static Cipher Keys (SCK), where one key is used for all radios and all calls. Key material is often exposed and SCK logistics of changing keys consist in programming all radios and Base Stations.

DCK is used for individually addressed TM-SDU (Service Data Unit). DCK/CCK encryption provides Derived Cipher Key (DCK) for uplink (from the radio to the BTS) communication and Common Cipher Key (CCK) for downlink (from the BTS to the radios) group communication. The DCK is derived from either the one way or mutual authentication process and the CCK is received during registry.

The radios supporting the dynamic key encryption identify themselves to the system as Class 3 radios during registry and attempt to negotiate Class 3 encryption. A Class 3 radio supports group addressed signaling and group call traffic encryption using CCKs as well as encryption of uplink and down link individually addressed signaling messages and individual call traffic (private or phone) using its DCKs. The radios support Over-the-Air-Rekeying (OTAR) of the CCK by the system.

A clear radio can set up calls to and receive calls from encrypted radios. The system informs the encrypted radios that the call is with a clear radio and they switch to clear operation. Class 2 and 3 radios can only act as described if they are allowed to operate in a lower class.

2.13.4.4

Group Cipher Keys Encryption (Class 3G)

For the Security Class 3G the system allows grouping addressed signaling and dedicated group call traffic encryption using GCKs to cryptographically isolate talkgroups. The downlink signaling is encrypted using MGCK that is cryptographically derived from the CCK associated with the serving cell and the GCK associated with a given talkgroup. The SwMI does not change GCK and CCK simultaneously. Whenever a GCK change occurs, CCK changes are frozen for this time period.

The DCK is derived from either the one way or mutual authentication process and the CCK is received during registry, whereas the GCK is received through OTAR mechanism only.

The radio supports over-the-air and manual provisioning of key associations that link a GCK to one or more TMO talkgroups, and manual provisionings of KAG to one or more DMO talkgroups.

The system can provide the ability for the operator to group contiguous ranges of TMO SSI. This case occurs where any talkgroup residing within the address range is assigned using the same GCK association. These ranges, referred to as Key Association Ranges (KAR), are used to convey the TMO talkgroup and GCK relationships to the relevant SwMI and radios responsible for GCK functions.

2.13.4.5

Over-the-Air-Rekeying

TETRA systems support GCK encryption for specific talkgroups:

- Group Over-the-Air-Rekeying (OTAR) of GCK.
- Group OTAR of fallback TM-SCK.
- Group OTAR of DM-SCK, including management of the cryptographic schedule of DM-SCKs.

The group OTAR mechanisms require a use of the group session key for OTAR (GSKO). The GSKO is delivered to the radio only by using individual OTAR and the session key for OTAR (KSO).

For the systems utilizing group OTAR, the fundamental system operation (regarding SCK/GCK OTAR) relies on the sites regular transmission. In other words, the sites are regularly broadcasting information regarding which security class and associated keys are in use. The sites transmit future versions of the respective keys to groups of radios belonging to the same cryptographic management group (CMG). The radios acquire the keys before the SwMI activates them. Then the air interface encryption service uses the keys. The sites also broadcast the current key that is in use which can be sent using OTAR mechanism to the radio on request.



NOTICE: When a radio has not received a new key before activation by the SwMI, the radio requests the missing keys.

Some systems adopt only individual OTAR methods for delivery of SCK and GCK to the radio. In such cases GSKO is not used. Some systems employ a mix of individual and group OTAR methods. The radio supports the complement to functionality required for supporting the superset of different SwMI behaviors, for example:

- Individual OTAR (using KSO) of SCK and GCK.
- Group OTAR (using GSKO) of SCK and GCK.

- Individual OTAR (using KSO) of GSKO.
- Secure DMO Key Management (via SwMI).
- Crypto Management Group.
- Storage of 10 KAG (equivalent to 30 DM-SCK).
- Storage of 16 GCK (includes current/future versions).
- Storage of 2 TM-SCK.
- Storage of Group Association attribute per Talkgroup.
- GCK Air Interface Encryption.
- Seamless key changes of GCK.
- Seamless security class changes to SC3G.

The SwMI can support the group OTAR feature. Where supported, the SwMI groups radios that share the same set of cryptographic key material into a specific crypto management group (CMG). Any radio belonging to the same CMG is addressed using a CMG GTSI. The primary purpose of the addressing is to transmit group OTAR messages conveying TM-SCK, DM-SCK and/or GCK. Any radio that supports TM-SCK group OTAR, DM-SCK group OTAR, or GCK group OTAR is assigned to a specific CMG.

Each CMG has a designated specific GSKO. The system deploys over the air a CMG GSKO (and CMG GTSI) to each radio belonging to the CMG. The GSKO is used as the sealing key for TM-SCK, DM-SCK, and GCK, when sent across the air interface. The SwMI can perform scheduled transmissions of the future TM-SCK addressed to each CMG. The radio requesting a TM-SCK triggers the site to schedule additional transmissions of the requested TM-SCKs. These transmissions are addressed to either the CMG GTSI that the radio belongs to or its ITSI.

The SwMI can perform scheduled background transmissions of the future GCKs addressed to each CMG. The radio requesting for a given GCK triggers the site to schedule additional transmissions of the current and the future versions associated of the requested GCK. These transmissions are addressed to either the CMG GTSI that the radio belongs to or its ITSI.

The SwMI can perform scheduled background transmissions of the current and the future DM-SCK addressed to each CMG. The radio requesting for a DM-SCK triggers the site to schedule additional transmissions of the requested DM-SCK. These transmissions are addressed to either the CMG GTSI that the radio belongs to or its ITSI.

2.13.4.6

Encryption Mobility

A Class 2 or Class 3 radio can operate on a lower class SwMI (depending on configuration). A radio that is provisioned not to allow operation on a lower class SwMI, does not register on such a cell.

A Class 2 or Class 3 radio moves to a cell that supports an SCK/CCK/GCK that the radio possesses, applies AIE to the registration PDU. If no acknowledgment is received, the radio sends the registration in clear.

2.13.4.7

Encryption MMI

A Class 2 or Class 3 radio that is involved in a clear call provides a visual and an audible indication informing that the call is not encrypted (if enabled by the service provider).

2.13.4.8

AIE Key Storage

The radio stores all the keys, SCK/CCK/DCK/GCK, in a sealed manner in non-volatile memory of the radio. However, they are not stored in the codeplug.

The radio supports loading of the SCK keys manually using the Key Variable Loader (KVL).

By using a special key combination, you can delete the cipher keys in the radio. Depending on configuration, you may erase either all keys or only the short-term keys.

2.13.4.9

Deleting User Keys

Prerequisites: The user key deletion is enabled in the codeplug.

Procedure:

- 1 Verify that the radio is turned on.
- 2 Press the following key sequence: *, *, 0, 0, #, #.



IMPORTANT: The key deletion takes up to 30 seconds. During the period, the battery must not be removed. Removing the battery during that period may lead to radio malfunction.

Encryption and/or Authentication keys are deleted. The radio enters Temporary Disable state and the service provider must manually restore it.

2.13.5

Secure DMO

The Secure Direct Mode Operation (DMO) feature guarantees key ciphered transmission in the DMO.

When DM-SCKs are provided by OTAR, you are informed in case the radio does not contain the complete set of SDMO keys. Whenever the radio enters DMO and the radio does not possess past and present DM-SCKs for all provisioned KAG and/or it has not yet successfully received SCK Subset Grouping Type, SCK Subset Number and SCK-VN information from the SwMI, then the radio:

- plays a special reject tone.
- prompts a message indicating **OTAR incomplete**.

The radio provides SDMO status information to the user via the MMI **DMOSCK Validity** submenu inside the **Security** menu (present only when configured in the codeplug):

- **DMO SCK is Valid** — DMO SCK OTAR is disabled and all DM-SCKs are provided using the KVL.
- **DMO SCK is Valid** — DMO SCK OTAR is enabled and the radio knows the current SCK information and has all the corresponding past and present DM-SCKs.
- **DMO SCK is Invalid** in all other cases.

The radio supports system management of SDMO keys. The radio using system managed SDMO requires the structure of DM-SCKs used for SDMO, the current active SCK Subset Number, and Version Number information to coordinate key schedules. The radio considers the last received variant of this information PDU as the most accurate indication of SDMO key configuration.

DMO SCK can only be used if Enhanced Security feature is purchased.

2.13.6

End-to-End Encryption

The TETRA standard supports air encryption. The radio creates the PDU (Protocol Data Unit) and the PDU is encrypted before transmission. The Base Station receives this PDU and must decrypt it, to know what to do with it and where to send it. Thus, if a PDU contains voice information, the voice part of the message has been decrypted and is now unprotected, until it is transmitted out to the caller.

Figure 6: Voice and Data End to End Encryption

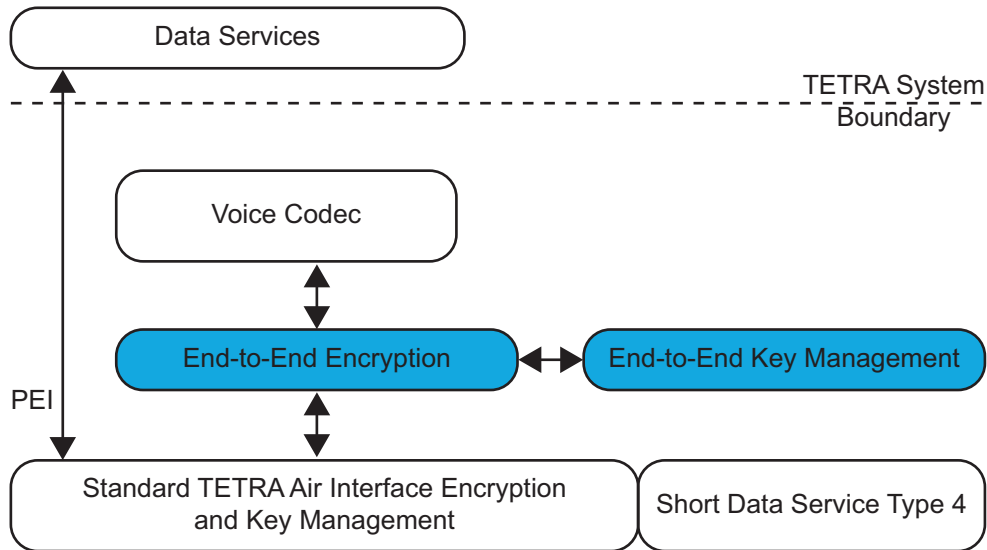

The End-to-End Encryption (E2EE) feature resolves this issue by encrypting the voice information before it is packed into the PDU. This message is also encrypted according to the over-the-air encryption of the TETRA standard. Thus, when the Base Station decrypts the PDU containing voice information, the voice part remains protected by encryption until the called radio receives the voice and decrypts it.

In the end-to-end encryption feature, the radio notifies and informs whether the call, being made or received, is voice-encrypted.

The radio supports BSI encryption in full duplex calls.

This feature is relevant for group calls and private calls in TMO and DMO.

2.13.7

SIM Security

The SIM security consists of the following security functionality groups:

- Voice E2EE and related key management.
- Network access parameters and authentication.
- Key management for AIE.
- OPTA, modification, encryption, and transfer.
- AES for E2EE of SIM Interface and SIM-Terminal Authentication.

The SIM security feature is only available on the GMOI network.

The SIM is an integrated circuit card, which holds a file system and an application. The application performs the following actions:

- Generation of key stream segments (KSS).

- Synchronization for E2EE.
- TETRA authentication algorithm based on K key on the SIM.
- Key management for E2EE keys.
- SIM interface encryption and authentication using the AES.

The file system holds the following.

- Network access parameters as ITSI.
- Security class definition and authentication definition.
- Integrated circuit card identifier.
- SIM version number.
- Operative Tactical Address (OPTA).

The E2EE keys are also kept on the SIM. However, they are accessible for the SIM application only, thus E2EE key management is transparent to the radio.

The keys for AIE remain on the radio. The SIM application handles AIE key management.

2.13.8

Radio Disable or Enable

A dispatcher can disable or enable the radio remotely.

When disabled, the radio does not participate in any voice call, Short Data Service (SDS), or packet data activity and ignores all supplementary services sent on the downlink. All visible and audible indications are disabled, and the radio appears to be turned off. All user inputs, such as key presses, are ignored, and the PEI interface is closed.

The radio continues to perform mobility management functions, such as roaming, to facilitate subsequent enabling or further disabling.

The radio stores the disabled or enabled state in the codeplug, so the unit remains in that state after turning on.

If the radio is in the disabled state, and receives an appropriate TETRA signaling for subscription enablement with the correct Short Subscriber Identity (SSI) and Mobile Network Identity (MNI), it restores to its normal operative state.

The TEI Query feature provides TEI information to the infrastructure during registration. This CONDI allows the dispatcher to disable radio by sending an appropriate TETRA signaling for equipment disable with the correct TEI for this radio. Replacing the SIM card does not activate the radio. TEI Query feature is only available on GMOI network.

If the radio is in the equipment disabled state, and receives an appropriate TETRA signaling with the correct TEI, the radio restores to its normal operative state (if the subscription is also in the enabled state).

2.13.9

Radio Permanent Disable

Radio Permanent Disable and Radio Permanent Disable v2 are paid features that are mutually exclusive.

Permanent disabling is intended to protect a network from attack from a compromised or faulty radio. It can be used when the radio has been compromised, or has been suspected of compromise for a long time. It is a one-way function and no equivalent enable is available. Then the radio should be recovered and reprogrammed before being used again by the service provider.

When the radio is permanently disabled, it becomes inoperable.

- All its MMI interfaces on the radio are disabled.
- All its security key material, that is GCK, GSKO, DMO SCKs, Ks, DCK, CCK, TMO SCKs are deleted.
- All its codeplug is deleted.
- All its software is deleted.

The permanent disable should be invoked when it has been determined that a radio is unrecoverable. When a radio has been lost or stolen, the first step always is to stun the radio using temporary disable.

The permanent disable should be used with the deletion of the user radio record in the User Configuration Server and the deletion of the K-REF association of the disabled radio in the Provisioning Center and the Authentication Center. This deletion ensures that subscriber information is not downloaded into the Home Location Register if a restore of the UCS is performed.

The system operator has to also ensure that the radio K-REF association is also removed from the other Authentication Centers in the network, in cases where the K-REF pairs are duplicated across the network.

If this association is not removed, the radio could be assigned a new home zone that lies in a cluster where the K-REF association has not been deleted.

2.13.10

Radio Permanent Disable v2

Radio Permanent Disable and Radio Permanent Disable v2 are paid features that are mutually exclusive.

Similar to permanent disable, once the radio is disabled using the permanent disable v2, it cannot be recovered over the air. When the radio accepts the permanent disable command, and if the permanent disable v2 flag is enabled in the codeplug, the radio appears to be inoperable.

- All its MMI interfaces on the radio appear to be disabled.
- All its security key material that is GCK, GSKO, DMO SCKs, Ks, DCK, CCK, TMO SCKs, and End-to-End key material are deleted.
- The radio automatically enters programming mode upon powering attempts.
- The permanent disable flag is set in the codeplug.

Unlike in the permanent disable, a permanent disabled v2 radio can be re-enabled using the software selling dongle. If you have the software selling dongle, you can read the codeplug and clear the permanent disable flag.



NOTICE: To restore a radio that is disabled using the permanent disable v2, see *TETRA Terminals CPS Start-up User Guide* (Motorola Solutions Part Number: 6802974C10).

2.13.11

High Assurance Boot

The radio has a facility that ensures that the code and data flashed in the radio is authentic and has not been altered.

The hardware forces the High Assurance Boot (HAB) module to run at boot time. The module checks if all software comes from a trusted source. The radio is checking the signature of the code and data segments present in the radio using a public/private key mechanism.

If the HAB authentication of the flashed software fails, it does not allow the radio software to run.

2.14

Packet Data

In Trunked Mode Operation (TMO), the radio provides a TETRA bearer service for applications that use the IP protocol. This service is available to external applications by connecting using the PEI.

The radio operates on the single-slot packet data channel by default or the multi-slot packet data channel. The multi-slot packet data channel is a paid feature.

The radio supports TETRA standard multi-slot packet data using the IP network layer protocol through Point-to-Point Protocol (PPP), and TETRA SMDCP protocol. The IP connection is established between Terminal Equipment and Mobile Terminal, allowing external applications to communicate with Terminal Equipment using predefined IP addresses.



NOTICE: This IP connection is referred as the local link. The link between the radio and the SwMI is referred as the wide link. When a wide link is established, the radio is in the wide mode.

Packet data applications reside internally, over UDP, or in an externally connected device, connected using an 8-wire RS232 data port in the radio.

Communication to external radio is initialized using AT commands. Once connection is established, the external application requests and operates in Point-to-Point Protocol (PPP) mode until data connection terminates.

The system provides Point-to-Point IP connectivity allowing the following datagram exchanges.

- Radio \longleftrightarrow External Equipment (Terminal Equipment) (for example PC).
- External Equipment (Terminal Equipment) \longleftrightarrow Network (through radio).

The radio supports only IP version 4 packets. The radio routes datagrams independently of the protocol sitting on top of IP.

The radio supports an MTU of 1500 bytes.

The radio provides a best effort delivery service. If the delivery fails due to the radio environment, the radio generates ICMP messages addressed to the Terminal Equipment. Delivery may fail due to the following reasons:

- no radio coverage.
- failed transmission.
- service interaction.

The packet data service Packet Data Channel (PDCH) access signaling has the same priority as a circuit mode setup-related signaling. The radio uses advanced link for packet data transmission and supports advanced link flow control. If the link does not disconnect between cells, advanced link roaming is supported.

The radio does not support data compression. Application attempts to negotiate data compression during context activation is rejected. If the SwMI sends a data compressed IP packet, it is silently discarded. The radio supports IP header compression negotiation received from Terminal Equipment during Packet Data Protocol (PDP) context activation and transparently transfers IP packets with the header compression between Terminal Equipment and the SwMI.

The packet data service employs the TETRA standard cell selection and re-selection. The packet data service suspends while the re-selection is occurring, and resumes when the cell re-selection procedure completes.



NOTICE: The cell re-selection is undeclared in a strict TETRA case. However, the SMDCP protocol defines a procedure for reconnecting the packet data service on the new cell. In this case, the cell re-selection procedure resembles the unannounced cell re-selection procedure.

2.14.1

Voice and Data Support

The radio can alternate voice and packet data service. However, voice and data running in parallel are not supported. This behavior corresponds to Packet Data Type B - IP dual mode.

If the SwMI rejects the context activation due to `PD MS type not supported`, the radio re-initiates context activation indicating that supports Type C. It is done to accommodate legacy SwMIs that uses an older definition of these types.

The radio supports transmitting and receiving SDS on the Packet Data Channel (PDCH). Thus, these services may be conducted in parallel.

The radio can operate in one of the voice-data interaction modes.

Voice Only Mode

You can select **Voice Only mode**, in which PD service is disabled. If an external application attempts to start up in this mode, PD registration for a wide link is rejected. If the PD service is active when this mode is selected, the radio deactivates PD. The PEI operates in the local mode only (data transfer between TE and MT).

Data Only Mode

You can select **Data only mode**, in which normal voice calls are not permitted. Incoming non-emergency voice calls are rejected, and you cannot initiate non-emergency voice calls. Incoming and outgoing emergency calls are allowed.

Voice and Data Mode

In **Voice and Data mode** any voice call activity that occurs during a data session takes priority over the PD. Once a voice call has interrupted the data session, the PD session is suspended, until the voice activity has ended. Then the session is resumed. Voice priority mode is the default mode.

You can choose one of the interaction modes. The choice of interaction mode is stored in non-volatile memory and remembered at power-up.

In **Voice and Data mode**, if the radio moves to the traffic channel due to the voice service, the radio terminates any active packet data transmission or reception. The data service is suspended. The data service resumes when the voice service ends.

The radio accepts any downlink Short Data Service (SDS) message received on the Packet Data Control Channel (PDCH). The radio can send uplink SDS messages on the PDCH.

The radio allows PEI, GNSS, and WAP packet data applications to activate and use the packet data context simultaneously. The first application initiates PD context activation. The next PD context activation from another PD application results in sending a reply indicating that the PD context is active. When WAP, GNSS, and PEI PD applications are using the active PD context, the radio can filter the downlink IP packets based on their TCP/UDP port.

- UDP packets addressed to the WAP port (configured in the codeplug) are routed to the WAP internal application.
- UDP packets addressed to the GNSS port (configured in the codeplug) are routed to the GNSS internal application.
- UDP packets not addressed to the WAP nor the GNSS ports are routed to the PEI, using Point-to-Point Protocol (PPP).



NOTICE: When activating another PD context on the radio, use the same settings in both PD contexts.

2.14.2

Packet Data IP Addressing

Table 6: Packet Data IP Addressing

Addressing Mode	Description
Wide IP Address	An IP address may be assigned to the terminal by the SwMI during the Packet Data (PD) context activation. When assigned, both Terminal Equipment and Mobile Terminal applications use this address as the source address in IP packets delivered to the infrastructure.
Local IP Address	By default both Terminal Equipment and the radio have their own IP addresses. Terminal Equipment and Mobile Terminal use these addresses for local datagram transmissions between Terminal Equipment and Mobile Terminal only and are not passed to the SwMI.
Static or Dynamic IP Address Assignment	The terminals support static and dynamic IP address assignment. The dynamic support is requested in the following situations: <ul style="list-style-type: none">• Request a Dynamic IP Address is set to Dynamic and the PD Application Type is the radio internal PD application.• Request a Dynamic IP Address is set to Dynamic and the PD Application Type is a PEI PD application requesting dynamic IP address.

2.14.3

Packet Data User Authentication

The Packet Data (PD) user authentication is a method of authenticating the Terminal Equipment user before allowing the packet data link activation.

A PD Authentication server connected to the SwMI authenticates the Terminal Equipment user. The terminal only sends the messages between the Terminal Equipment and the SwMI. In the wide mode, the terminal offers Point-to-Point Protocol (PPP) user authentication between Mobile Terminal and Terminal Equipment using Password Authentication Protocol (PAP) or Challenge Handshake Authentication Protocol (CHAP), before the IP link is established. The terminal always attempts to negotiate usage of the CHAP method. However, the radio agrees to use PAP, when the Terminal Equipment application insists. If the terminal does not require PD user authentication, it operates without any user authentication. However, if the terminal requires the PD user authentication, it rejects the Packet Data Protocol (PDP) context activation.



NOTICE: If the SwMI does not agree for the authentication method, for example PAP, the SwMI can reject it.

2.15

TETRA Network Protocol 1

TETRA Network Protocol type 1 (TNP1) is a bridge protocol based on the TETRA layer 3 over the air protocol. The TNP1 supports all TETRA dispatch functionality.

In the Trunked Mode Operation (TMO), the TNP1 specifies a protocol for use over the PEI, that allows Terminal Equipment (TE) to have control over the TETRA services: mobility management, call control, short data service, and supplementary services: send GNSS reports, software information, and battery state information. In addition, commands to access the radio configuration and storage parameters are available.

The radio supports TETRA standard packet data using the IP network layer protocol.

The radio can operate both on the single slot packet data channel and the multi-slot packet data channel.

Packet data applications reside internally, for example: GNSS reports, WAP, or in an external device connected to the 8-wire RS232 data port on the radio. Communication to the external device is initialized using AT commands.

The system provides point-to-point IP connectivity allowing the following datagram exchanges:

- Radio \longleftrightarrow External Equipment (TE) (for example PC).
- External Equipment (TE) \longleftrightarrow Network (through radio).

The radio supports IP version 4 packet.

TNP1 services can use one of two Point-to-Point Protocol (PPP) methods to connect from the terminal equipment to the radio, local mode, and wide mode. The TNP1 should be used in wide-mode wherever possible, to allow the parallel operation of TNP1-SDS services and packet data services over a common PPP link.

If the transmit inhibit is entered, the radio drops the wide mode connection, thus the PEI goes back to AT mode. Then the TNP1 client detects this change and reinitiates the PPP session in local mode.

The radio disables the TNP1 session while being in the Direct Mode Operation (DMO).

AT commands are used to initiate the PPP service for TNP1 to operate. Once the PPP session is running all AT commands are blocked. When the PPP session is closed, AT commands are available.

2.15.1

TETRA Network Protocol 1 IP Addressing

Table 7: TETRA Network Protocol 1 (TNP1) IP Addressing

Addressing Mode	Description
Wide Mode	All TNP1 services are available including packet data transfer towards the SwMI. The address used is the dynamic address MS IP or configured statically.
Local Mode	All TNP1 services are available except packet data transfer. The addresses used are the two static addresses TE IP: 10.0.0.101 and MT IP: 10.0.0.100.
Port Addressing	The radio uses a fixed port address for reception and transmission of TNP1 packets. The port number is 4024.

2.16

Mobility Services

Terminal mobility indicates the ability of a terminal to acquire, register, and operate on an appropriate TETRA network and also to change cells when the conditions require it with a minimum interruption of services.

2.16.1

Main Control Channel Frequencies

The radio can find a wide range of main control channels. The radio maintains stored lists of carrier frequencies which are scanned in order.

- 1 A list of discrete entries of the last 32 control channels used by the radio.
- 2 A static list of up to 32 discrete frequencies specified by the operator that can be preprovisioned. The system operator can modify this list using the programming tool.

- 3 A frequency range specification, using a specific offset, that can be preprogrammed in the factory. The system operator can modify this range using the programming tool. Then the radio scans all frequencies in 25 kHz intervals in the specified range.
- 4 An extra frequency range specification. Having two separate range specifications allows for two non-contiguous blocks of frequencies or two different offsets.

The radio can use all four frequency lists to speed up registration process after a power cycle or loss of Trunked Mode Operation (TMO) coverage.

2.16.2

Control Channel Selection

Each TDMA frame on a given carrier comprises of four time slots, which any slot can be used as a physical channel.

The following types of physical channels are available:

- Traffic physical (TP) channel - used primarily for circuit call traffic.
- Control physical (CP) channel - dedicated only for signaling.
- Packed Data Control (PDCH) channel - dedicated for Packet Data traffic.
- Unallocated physical (UP) channel.

The following types of control channels are available:

- Main Control Channel (MCCH) - occupies the first slot of the main carrier.
- Secondary Control Channel (SCCH) - can be used to extend Control Channel capacity.

The following types of SCCH are available:

- Common SCCH
- Assigned SCCH

In addition to the MCCH, a cell can have up to three common SCCHs, which could occupy slots 2, 3, and 4 in the main carrier. This solution allows the radio to distribute its population among up to four channels and so to increase Control Channel capacity at the expense of traffic channel capacity.

Until having received a specific parameter on a cell, the radio uses the MCCH. When the signal is received, each radio maps itself to a particular common SCCH, and that SCCH operates as the MCCH for the radio.

Secondary Control Channel (SCCH) is a paid feature.

2.16.3

Registration

On camping on a cell, the radio sends a registration request PDU to the SwMI, which includes a request to attach to the selected talkgroup.

If the registration and attachment succeed, the radio begins normal operation on the cell. If the registration attempt times out, or the SwMI rejects the registration for a temporary reason, another registration attempt is made. If both attempts fail, the radio attempts to camp on a different cell.

If the SwMI denies the registration request due to the location area rejection, the radio does not attempt to register again at this cell until the next power-on. The radio supports the modification of its subscriber class on receipt of a new subscriber class from the SwMI in the registration acknowledgment PDU. This subscriber class is used until turning off the radio or next Individual TETRA Subscriber Identity (ITSI) attach.

The radio does not send registration signaling when one of the following occurs:

- Roaming and registration fail before the radio receives the random access acknowledgment and the radio goes back to the last serving cell.
- The radio discovers a link failure on the serving cell, the link failure is shorter than the predefined timer and the radio is not in the transmit inhibit mode.
- The radio discovers a link failure on the serving cell and is in the transmit inhibit mode. In this case, the radio always goes back to the serving cell without registration and stays in the transmit inhibit mode until the mode is turned off.



NOTICE: When two or more scenarios occur at the same time, the radio registers with signaling.

If the radio discovers a link failure on the serving cell, a specific timer starts counting. If the link failure remains after the timer expires, then the radio acts as during a normal link failure. If the link failure ends before timer expires, then the radio goes back to the serving cell without registration. This mechanism ensures that unnecessary registration is avoided.

When a radio is out of the serving cell range for a period shorter than configured in the codeplug, then the radio does not register to go back in the range.

2.16.4

Call Roaming

The radio continually monitors neighbor cells and scans the highest ranked neighbor cell.

When the state of the highest ranked neighbor cell is sufficiently better than the serving cell, or when the radio has lost the serving cell, the radio employs cell reselection procedures using the following methods:

- If not in a call - undeclared cell reselection.
- If in a call and not transmitting or link failure occurs - unannounced cell reselection.
- If transmitting in a call, and a neighbor has been scanned, and the cells are synchronized - announced type-1 or type-2 cell reselection.
- If transmitting in a call and no neighbor has been scanned or the cells are not synchronized - announced type-3 cell reselection.

For compatibility with systems that do not support type-1 or type-2 cell reselection, the radio can be provisioned to never perform these types of reselections.

The radio decides on the need for cell reselection, based on comparison of the signal strength and the service level between the serving cell and neighbor cells. The service level criteria are based on the following criteria listed in priority order:

- 1 System Wide Services available (Local or Wide Trunking)
- 2 Valid or Invalid Subscriber Class
- 3 Relinquishing criteria
- 4 Congestion level
- 5 Security Class
- 6 Subscriber Class
- 7 Home Location Area (Home Location area)
- 8 LA Boundary
- 9 Cell Load

The radio prefers a cell that has a higher service level to one with a lower service level. If the radio is operating on a serving cell that has a lower service level than a neighbor cell, the radio roams to the neighbor, even during a call.

During network reconfiguration, a significant number of radios registered on one cell may roam. This roaming can cause major congestion on specific cells. To avoid the congestion on control channels for the specific cells, the specified radios roaming should be distributed in time.

As the operation cannot be performed immediately for all the radios, some of the radios must wait longer to roam. The time cannot be programmed not to cause any of the radios to have inferior roaming capabilities. Thus the roaming time for the radios is randomized.

The randomization means that after roaming scenario starts, a radio is not sending registration parameters to other cells at once but waits random time before sending registration PDUs to other cells. Link failures and other related scenarios are not randomized not to cause any unwanted delays in restoring the link.

2.16.5

Seamless Handover

Seamless handover eliminates voice interruption during calls by enabling the radio to roam faster between cells while transmitting.

Faster roaming is possible because the radio asks its serving cell to perform the reselection and the SwMI performs all the roaming signaling. The radio then moves straight to the traffic channel on the new cell and continues the call without call restoration.

2.16.6

Networks

The radio holds a list of 101 allowed network identities (including 1 home network and 100 foreign networks) with a combination of Mobile Country Code (MCC) and Mobile Network Code (MNC).

Each network can have an associated name that can indicate to the user which network it is. The radio can perform initial cell selection and registration on these networks. You can limit registration to the home network only, selected network only, or any network.

The radio selects the network registration method based on the following Customer Programming Software (CPS) configurations:

Migration Signaling

If the network supports migration, the radio registers to the network using migration signaling.

ITSI Attach

The radio registers to the network using regular Individual TETRA Subscriber Identity (ITSI) attachment.

Automatic

The radio uses migration signaling or ITSI attachment to register to the network, depending on the capabilities of the network.

The radio operates in all networks similar to its operation in the home network, with some behavior configurable using the CPS. All group calls are placed using Short Subscriber Identity (SSI) addresses. It is the responsibility of the Switching and Management Infrastructure (SwMI) to reject calls for groups that the local system cannot reach, or connect the calls to another foreign system. Individual calls are placed using SSI addresses for intra-network calls, or TETRA Subscriber Identity (TSI) for inter-network calls.

If the registration method is ITSI Attach or if the Migration Encryption feature is enabled, the following features are configurable in the CPS for the foreign network:

- Authentication
- Air Interface Encryption (AIE)
- Encryption



NOTICE: The telephone gateway interprets telephone numbers with the country code of the local country. For example, if you dial the number 01256-48-4566 in the UK, the system treats as if you dial +44-1256-48-4566.

2.16.6.1

Migration

Migration is a paid feature.

The Migration feature enables the radio to migrate and register to a foreign network using migration signaling. This condition allows the radio to attach to talkgroups in the foreign network.

This feature consists of the following key functions:

- If you change talkgroup to one on a different network, the radio automatically migrates to this network or to one of the available networks. It gives you the option of automatically migrating to an available network in the region. It is useful if the signal is lost as the radio attempts to establish communication with any available network. Your service provider must preconfigure the codeplug with the network before assigning it to talkgroups.
- The service provider can set the registration method to individual networks. Also, the service provider can set an automatic registration method, depending on the network broadcast.

The Migration feature supports individual call, group call, and individually addressed Short Data Service (SDS) or Status messages. To receive group calls or group-addressed Short Data Service (SDS) or Status messages from a group of the current network, the radio has to attach to the nominated group. To receive group calls or group-addressed SDS or Status messages from other networks, the attached talkgroup must be configured in the Switching and Management Infrastructure (SwMI) as an ISI talkgroup.

The radio cannot migrate to a foreign network while it is in an active call.

2.16.6.2

Network Selection

You can select one or multiple preprogrammed networks to register your radio to.

The following network options are only available when the radio is in Trunked Mode Operation (TMO) or Gateway mode:

Networks Sel

In this option, you can select the network to which the radio is allowed to register.

Home Only

The radio registers only to its home network, even if it finds a foreign network that is in range first.

Select Net

This option allows you to manually select a preferred network from a list of configured networks. As a result, the radio registers only to this selected network, even if it finds another network that is in range first.

Any Network

In this option, if the home network is not available, the radio selects the network automatically. The radio registers to any network that is already configured into its codeplug list of networks. This option does not require manual selection. Network selection to another network is only performed at initial cell selection following a link failure and then only if the home network is not available.

If the radio chooses a network different from the current one, the radio may force initial cell selection to find a cell that belongs to the home or the selected network. In the selected network option, the radio displays a list of network names where each network name corresponds to one of the Mobile Network Identities (MNI) in the list. The network names are configured in the radio as part of the configuration of the MNI list.

2.16.7

Congested Cell Handling

This feature is used only during initial registration and when roaming between sites. It is not used when camped on a site that has become busy or congested due to no free traffic channel to make or receive calls.

When the cell that the terminal is trying to register is congested, a special level-based algorithm is in the place. Depending on the level of congestion, the terminal is waiting for the registration or is rejected on that cell.

The terminal recognizes whether the cell is congested (Control Channel Congestion). The terminal tries to roam to not congested cells first, ranking congested ones as secondary. The cell congestion is one of the service level criteria.

The following cells are never marked as congested.

- Last suitable cell - if there are no other suitable cells during roaming or initial cell selection.
- Serving cell.

The feature is configurable using the Customer Programming Software (CPS).

2.16.8

Subscriber Class

When the radio powers up, or whenever it performs registration or roaming, it always uses its provisioned Subscriber Class (SC).

When the radio registers on a cell that does not support any of its SCs, it is active only in services that have the emergency priority.

Whenever the radio SC does not match the cell SC (the feature is configurable using the CPS), it either uses normal ranking procedures (see [Call Roaming on page 61](#)), or does not roam to the cell at all.

2.16.9

Subscriber Class by Talkgroup

Subscriber Class by Talkgroup is a paid feature.

You can configure up to 16 Subscriber Class by Groups in the Customer Programming Software (CPS) by assigning talkgroups to Subscriber Classes. The talkgroups can be assigned to more than one Subscriber Class according to the Group Short Subscriber Identity (GSSI) or by the folder of the talkgroup, except for the Favorite folder. If a talkgroup is assigned to more than one Subscriber Class, the radio uses the first assigned Subscriber Class.

A radio Subscriber Class changes when the user changes to a talkgroup with a different Subscriber Class. A Subscriber Class received from the SwMI, over the air, has a higher priority than Subscriber Class by Groups. If the radio is not already using this Subscriber Class, it automatically changes to it.

The Subscriber Class by Talkgroup feature is useful in the following examples:

- Preserving traffic channel capacity. Two cells with the same coverage are placed together to multiply traffic capacity. Radios attached to Talkgroup 1 are registering on these two cells. As a result, traffic channel capacity is reduced as two channels are being used. The Subscriber Class by Talkgroup feature directs radios registered on the second cell to roam to the first cell, thus increasing traffic channel capacity.
- Distributing radios across cells and prohibiting them from roaming to mismatched cells. When there are many radios in a small area with multiple Base Transceiver Station (BTS), congestion occurs because of high roaming traffic. The Subscriber Class by Talkgroup feature directs radios attached to the same talkgroup to roam to a matching Subscriber Class cell. Also, it does not allow radios to roam to a mismatched Subscriber Class cell.

The Subscriber Class by Talkgroup feature does not apply to supergroups as they are regarded as scanned groups.

2.16.10

RF Power Class Toggle

RF Power Class Toggle is a paid feature.

The RF power toggle is a radio-specific hardware feature enabling the radio to transmit with Class 3L (1.8 W) power.

Using the Customer Programming Software (CPS) the power class can be set for the radio to transmit with Class 3L (1.8 W) or Class 4 (1 W). Depending on the codeplug settings, you can toggle through the interface, between high and normal RF power.

The radio can be configured to switch automatically to Class 3L (1.8 W) on entering Direct Mode Operation (DMO) and to automatically switch to Class 4 (1 W) on entering Trunked Mode Operation (TMO).

Changing RF power class is performed immediately. The change can be done, for example, during a call. Such action may result in dropping the call, as the selected power class setting can be insufficient to sustain the transmission.

2.16.11

Local Site Trunking

Local Site Trunking (LST) is a feature enabling a Base Station to operate stand-alone. The Base Station may enter the mode when the link from the local cell to the central switch has gone down. The radio limits functionality when the cell is in this mode.



NOTICE: Whether a radio can register on cells in LST depends on the codeplug settings.

If system broadcasts indicate that system-wide services are not available (LST) on a cell, the radio registers on this cell only if there are no system-wide cells available.

Depending on the infrastructure settings, when the radio is operating on an LST cell, the radio may prevent you from invoking the following services:

- Private call
- Phone call
- Private Automatic Branch Exchange (PABX) call
- Packet data
- Short Data Service (SDS) data

Depending on the codeplug configuration, the radio may indicate entering the LST with the following notifications:

- Visible and audible
- Visible
- Audible
- None

To avoid unnecessary roaming and reduce congestion, Local Site Trunking Ignoring feature can be enabled. When Local Site Trunking Ignoring feature is enabled, the radio temporarily ignores the LST/WST parameter when selecting a site. However, the radio still takes other parameters such as the Radio Signal Strength Indicator (RSSI) level of the cell into consideration when deciding on roaming.

Local Site Trunking Ignoring is a paid feature.

2.17

Supplementary Services

Following is the description of the TETRA Supplementary Services (SS) that the radio supports in the Trunked Mode Operation (TMO).

2.17.1

Dynamic Group Number Assignment

The radio supports dynamic addition and removal of talkgroups in its talkgroup list through TETRA Dynamic Group Number Assignment (DGNA) and De-assignment signaling (SS-DGNA).

The radio responds to DGNA directed to it or to DGNA directed to a group the radio is attached to even if the talkgroup is not programmed in the codeplug.

When a DGNA request to add a talkgroup is received, the radio adds the group in the first available spot in the talkgroup list in the codeplug. Then you can scroll to the talkgroup to select the group. The codeplug determines which DGNA operations are allowed for a group.

Depending on the group type, the following is allowed:

- Static - only selection is allowed.
- Semi-Static - selection and reassignment are allowed.
- Dynamic – selection, de-assignment, and reassignment are allowed.

The groups can be assigned as not attached, attached as scanned or attached as selected.

Assignment of the group through DGNA with attached as selected makes it the selected group of the radio. If the group is assigned with attached as scanned, if it is not already in the currently active scan list, the radio adds this group to a SwMI Controlled scan list and begins monitoring downlink signaling addressed to this group. The SwMI controlled list holds up to ten groups, and the radio monitors these groups as well as groups in the user scan list.

If the talkgroup list is full when adding a group, the radio rejects the assignment operation. If the SwMI controlled list is full and the assignment is with attached as scanned, the attachment is rejected.

When a talkgroup de-assignment is received, depending on the codeplug settings (DGNA Operations field in the Talkgroup List) the radio behavior is as follows:

- If the DGNA Operations field is set to Static or Semi-Static, the radio;
 - leaves the talkgroup and the parameters assignments to folders unchanged.
 - sends an acknowledgment PDU with notification the group definition has been removed.
- If the DGNA Operations field is set to Dynamic or if the group is not in the talkgroup list, the radio;
 - removes the talkgroup from the talkgroup list, if the talkgroup is in the list.
 - removes all the occurrences of the talkgroup from the folder list.
 - sends an acknowledgment PDU with notification the group definition has been removed (also if the talkgroup has been deleted, or the talkgroup does not exist in the radio).

Even if the talkgroup is de-assigned, the radio can receive group calls or emergency group calls for any assigned scan list.

If the de-assignment is for a group in the scan list, the group remains in the list. However, it is not monitored.

If the de-assignment is for a group in the SwMI controlled list, the group is removed from the list.

If the de-assignment is for the selected group, depending on the service provider settings, the radio;

- notifies that there is no group attached, when in the group mode, and does not attach to another talkgroup automatically.

- attaches to the previously selected talkgroup, which is the talkgroup it was attached to before the DGNA being assigned. If the previous selected group is not present then the radio shows that there is no group attached and displays `No Group`.
- attaches to a default talkgroup configured by the service provider. If the default talkgroup is unavailable (it was deleted), the radio enters the `No Group` state.

At each talkgroup change, an appropriate notification is shown on the display.

If the de-assignment is for an announcement group, the talkgroup is removed from the talkgroup list. Also, all the groups that are associated with this announcement group do not have an associated announcement group. If the currently selected talkgroup is associated with this announcement group, the radio stops scanning the associated announcement group.

If DGNA user notification is provisioned, the user is notified once the DGNA operation is successful. For example, when a group is added or deleted. The notification is displayed until you confirm the operation. In case you receive a call, the message continues displaying until you confirm it.

On viewing an assigned talkgroup notification, the radio provides the ability for the user to make that group to be a selected group.

The radio supports the reception of a DGNA Assignment that is addressed to its selected talkgroup as a supergroup of the selected group. All signaling addressed to the supergroup is monitored in addition to signaling addressed to the selected group, any announcement or associated groups, and groups in the active scan lists.

When the selected group is unselected, the radio ceases processing signaling to the supergroup that was associated with that selected group.

The radio receives the lifetime of the supergroup as part of the assignment signaling. If a subsequent assignment to the same group is not received within that lifetime, the radio ceases monitoring that supergroup.

The radio also supports supergroups of scanned groups, such that a group addressed DGNA assignment received on one of the user scan group addresses causes the radio to monitor all signaling addressed to that supergroup as long as the scan group is being monitored, and as long as the supergroup lifetime lasts.

The following DGNA functions are not supported:

- Call-related DGNA.
- Functionality of the authorized user.
- Network authentication before accepting DGNA.

2.17.2

Ambience Listening

The Ambience Listening (AL) feature allows a console operator or dispatcher to monitor audio activity near a specific radio without giving any indication to the affected radio.

When the radio receives a call setup message with an AL call, the radio accepts the call. Then the radio opens the microphone, and begins transmitting without showing any indication of the call. Call acceptance and rejection while active in another call follows the PPC rules.

The radio imposes no time limit on the transmission. The radio continues to transmit until the SwMI ends the call or when you perform an action that releases the call. If you attempt to start a service while the AL call is in progress, the radio disconnects the call and initiates the requested service. The radio allows performing actions that can be performed without releasing the AL call. These actions include access of most menu items, activating, deactivating scan lists, and changing talkgroups. When changing talkgroups, the radio appears as if it is performing an attachment. The attachment appears to be successful, but the actual attachment signaling is performed only after the AL call terminates. When

performing the attachment after the call, no indication is shown to the user unless the attachment fails. If you attempt to power down the radio in the active AL call, the radio enters Pseudo Power-Off state.

2.17.3

Pseudo Power-Off

If you attempt to power down the radio in the active Ambience Listening (AL) call, the radio appears to turn off. However, it remains fully operational from Layer-3 and below. The radio has a blank screen, and all LEDs are turned off.

When the AL call ends in this pseudo power-off state, the radio automatically turns off.

If you attempt to power up the radio from the pseudo power-off state, the radio acts as if it is really powering up.

2.17.4

Auto Power-On

The radio can be configured to turn on automatically after inserting the battery. This functionality is configurable using CPS.

If the emergency mode was active before removing the battery, the radio enters this mode when the power-off period is shorter than approximately 3 seconds. This behavior applies to normal and silent emergency modes. The three-second period is approximate and determined by the discharge rate of capacitors in the radio. The period may last from 3 up to 6 seconds.

2.17.5

Preemptive Priority Call

If during a call, a call setup is received for a call with higher priority than the present call, and the new call priority is Preemptive Priority 3 (value 14 in the codeplug) or Preemptive Priority 4 – Emergency (value 15 in the codeplug), the radio disconnects from the present call and joins the new high priority call.

If the call priority of the new call is Preemptive Priority 1 (12) or Preemptive Priority 2 (13), depending on configuration, the radio either accepts or rejects the new call.

When the new call is accepted, a special tone is played, and you are notified of the high priority call.

When you initiate a private call and you receive a rejection with the reason `Called party busy`, you have the option to interrupt the existing call or initiate a new call. However, this time the call is initiated with the preemptive priority.

2.17.6

Transmit Inhibit Mode

The Transmit Inhibit (TXI) Mode is a mode in which the radio sends no radio transmissions. Activate this mode in RF sensitive areas, for example hospitals, airplanes, where safety can be jeopardized due to transmission radiation.

To activate, select **Menu** → **More** . . → **Networks** → **TXI Mode** → **Activate**.

In this mode, the radio does not transmit under any circumstances except for the Emergency Calls. All the functions and keys which cause transmission, for example registration to the network, changing talkgroup or folder, sending SDS messages, or pressing the **PTT** button are disabled. Any transmission attempt causes the radio to display `Not Allowed In TXI Mode` notification and to play a tone.

Your radio can still receive:

- Group calls.

- Messages - stored in the **Inbox**.
- Private call attempts - stored in the **Missed Calls** list, without the option to respond.

When no danger to safety exists anymore, for example, when you leave the RF sensitive area, you can deactivate the TXI Mode and the radio returns to standard operation.

You can deactivate the mode by selecting **Menu** → **More. . .** → **Networks** → **TXI Mode** → **Deactivate**, pressing One-Touch Button, or implicitly when initiating an Emergency Call.



NOTICE: RF Transmissions from the radio are prevented under the following conditions:

- TXI Mode is activated.
- Battery is removed.
- The radio is turned off.

On entering or exiting the TXI mode, when the radio is camped on a cell, it sends a specially designated Short Data Service (SDS) status message. This SDS message indicates to the SwMI that the radio is entering or exiting TXI mode.

Mobility procedures that do not require the radio to send an uplink transmission are performed except for cell reselection.

In TXI mode, the radio joins group calls for any group that the radio is monitoring, but the transmitting on that call is still prohibited.

The radio also displays any incoming SDS messages to the user. The missed call feature is active in the TXI mode and allows checking what calls were missed. However, the radio attempts to prevent call setup retransmission from being recorded as separate calls.

If you initiate an emergency call, the radio immediately leaves TXI mode and attempts to start the emergency call if the radio is in service.

If the radio is turned off in the TXI mode, on turning on, the radio asks whether to exit the TXI mode. If you choose **No**, the radio turns off.

2.17.7

Calling Line Identification Presentation

If the radio is provisioned with the Calling Line Identification Presentation (CLIP), the calling party number is transported as part of the incoming call setup signaling.

Also the calling party number is shown on the radio display. If the calling party ID is programmed in the radio with a corresponding name, the name is displayed in addition to the number.



NOTICE: The number sent by the SwMI is expected to be in a form that can be used to call back the calling party at any other time. Thus, for instance, the number can be stored in the address book.

If the calling party number is not present in the incoming call setup signaling, a blank line is displayed in its place.

2.17.8

DTMF Overdial

This supplementary service allows the radio to send DTMF tones to both internal and the external network during the call (conversation). It is only possible to send DTMFs when in a full duplex call. This feature can be disabled in the codeplug (enabled by default).

2.17.9

Universal Time Display

The radio can present time information to the user. The time is derived from an internal clock. The radio maintains the clock both when the radio is powered on and powered off.



NOTICE: If the power is lost, for example due to the flat battery, the internal clock is not maintained.

To ensure the time displayed is accurate, the time is displayed only if within the last 48 hours either of the following events have occurred:

- The radio has received a network time update from the system.
- You have manually updated the time.

Also, as the internal clock is not maintained after a power loss event, the time is not displayed until either these events occur.

The feature is enabled or disabled and the default configuration can be set for the radio using the Customer Programming Software (CPS) or radio MMI.

The radio display supports the following:

- Twenty-four-hour and twelve-hour formats.
- DD/MM/YY, MM/DD/YY, DD-MON-YY, and YY/MM/DD date formats.

You can change the time and configuration information through the MMI, depending on the codeplug settings. Depending on configuration, system broadcast information can have higher priority than data entered manually. Thus time, date, and offset information entered from the MMI is overwritten, when data is received from the SwMI. The radio provides user indications upon crossing to another time zone, when a new Mobile Country Code (MCC) broadcast received.

2.18

Man Down



NOTICE: This feature is a paid feature.

Man Down alerts when no movement occurs for a set time or the radio stays at an angle of tilt below a defined value. The radio alerts you when:

- Its tilt exceeds a predefined angle value.
- No movement is detected in a predefined time interval.

In case any of the conditions are met, the radio alerts you with a Man Down pre-alert. If you do not remove the pre-alert condition, the radio switches to the Emergency Operation.

For the easier localization of the radio, visual and audible indications are started until they are deactivated. If the Emergency Hot Microphone is on, the additional audio indication is not played.

To exit Man Down, exit the Emergency Mode by pressing and holding the **Exit Soft** key, or press the **PTT** button.

2.18.1

Man Down (Operation)

Man Down can be disabled or enabled from the menu or by OTB.

If the man down feature is deactivated with a One-Touch Button, the radio plays an audio tone once. If the feature is deactivated using the menu, the radio does not play the tone.

The man down feature is based on a sensor with low-power current consumption. When Man Down is enabled the sensor performs a self-test during powering on the radio. If the test fails, the radio notifies with a specific audio tone and status icon. The radio also notifies with the specific audio tone and status icon, when the man down device detects a failure during the activation of the feature.

If the feature is deactivated using radio MMI after the sensor failure is detected, the man down icon disappears and the tone is no longer played.

Depending on the CPS settings, extra audio and/or visual indications are available to help locate the radio. In such case, if the man down alarm is activated (emergency alarm started), the radio starts additional audio indication playing high and low frequency sounds continuously, with highest possible volume. The radio display and/or keypad may also start blinking.

If the emergency hot microphone is on, the additional audio indication is not played.

2.19

Vibrate Alert

The Vibrate menu allows you to determine if the radio vibrates, rings, or vibrates and then rings when receiving a call.

2.20

Repeater Mode

Repeater mode is a paid feature.

The Repeater Mode provides repeater connectivity between radios operating in the DMO Mode. Only the radios on the same talkgroup can communicate with each other through the repeater. Also, only one repeater can be used in one setup. Chain repeaters are not allowed.

Figure 7: Repeater Mode Operation

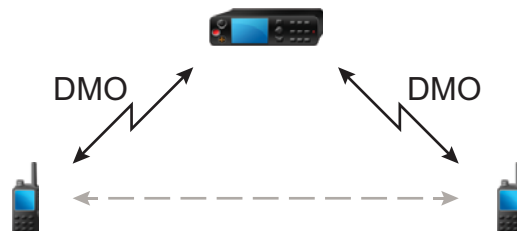

A DMO repeater is used to extend the DMO range by retransmitting received information from one radio to another. It retransmits group calls, private calls, and data on a given frequency.

The repeater sends presence signal periodically on a free channel to allow other radios to synchronize on a given frequency.

The communication between radios and the DMO repeater is logically divided in two links. The term “master link” is used for all communication taking place between the Master radio and the DMO repeater.

The term “slave link” is used for all communication taking place between slave radio and the DMO repeater. The master is the radio initiating and transmitting the voice or data and the slave is the radio receiving the voice or data.

You can enable Call Monitoring of ongoing call to hear what is being transmitted. You can enable Interactive Repeater to hear and take part in the transmitted call.

For more information, refer to [DMO Gateway and Repeater Communication on page 72](#).

2.21

DMO Gateway and Repeater Communication

The radio provides the capability of communicating in Direct Mode Operation (DMO) with a Trunked Mode Operation (TMO) group via the Interoperability (IOP) certified gateways.

A DMO repeater re-transmits information received from one DMO radio to other DMO radios over the DMO air interface.

For each DMO talkgroup, the radio allows operating in one of the following modes:

Radio to radio only

The radio initiates calls only on a talkgroup directly and not through a gateway or repeater.

Specific gateway

The radio can initiate calls on a talkgroup directly or through a specific gateway address that is specified for a talkgroup. The gateway address can be edited through the radio MMI.

Auto gateway

The radio can initiate calls on the selected talkgroup directly with another radio or through any available gateway that is detected as present.

Repeater

The talkgroup links to a DMO repeater.

Specific gateway and repeater

The radio uses only the gateway with the specified gateway address for the talkgroup and/or a DMO repeater.

Automatic gateway and repeater

The radio uses the first available gateway for a talkgroup and/or a DMO repeater. If either specific gateway or auto gateway mode is chosen, and a suitable gateway is found, all outgoing calls are placed through the gateway. If a suitable gateway is not found, or a call setup through the gateway fails, the radio attempts to set up the call directly.

When operating on a gateway and/or repeater, the radio indicates the communication mode.

2.21.1

Communication through Repeaters

Radios that are out of range and cannot communicate directly one with another in Direct Mode Operation (DMO) can do it through the repeater. The repeater is a radio that repeats all communication on a chosen channel, and as a result increases radios DMO range.

Figure 8: Communication through Repeaters

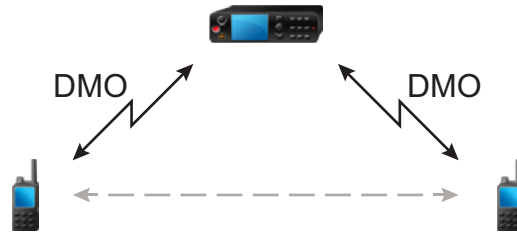

When the radio connects to a repeater, it plays a tone, displays the `Repeater available` message, and shows an appropriate icon. When the radio loses connection with the repeater, it plays a tone, displays the `Repeater not available` message, and the repeater icon is blinking.

2.21.2

Communication through Gateways

Gateway provides connectivity between radios operating in Direct Mode Operation (DMO) and the TETRA network, so that the DMO radios can communicate with the Trunked Mode Operation (TMO) radios.

Figure 9: Communication through Gateways

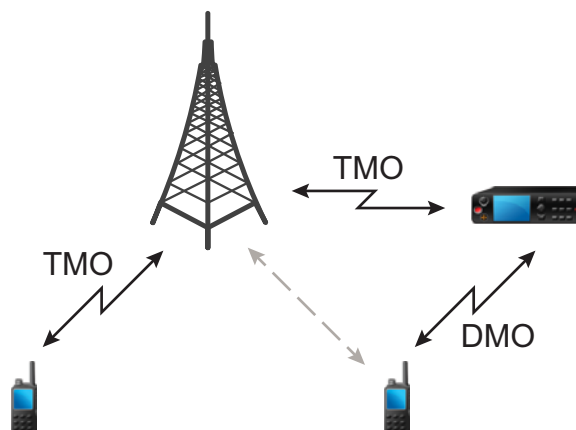

When the radio connects to a gateway, it plays a tone, displays the `Gateway available` message, and shows an appropriate icon. When the radio loses connection with the gateway, it plays a tone, displays the `Gateway not available` message, and the gateway icon is blinking.

2.21.3

SDS through DMO Gateways or Repeaters

Radios operating in DMO can send the following message types to other radios through DMO Gateways or Repeaters:

- SDS Status
- SDS User-Defined Data Types 1, 2, 3
- SDS User-Defined Data Type 4 with or without SDS Transport Layer (SDS - TL)
- GNSS/GPS LIP messages

Both DMO Gateways and Repeaters can forward messages in Reservation and Idle mode. The supported forwarding directions are:

- DMO group address to TMO group address.
- TMO group address to DMO group address.
- DMO individual address to TMO group address.
- TMO individual address to DMO individual address.

2.21.4

Gateway and Repeater Synchronization

To communicate via gateways or repeaters, the radio requires synchronization with a gateway or a repeater.

A gateway or a repeater sends presence signals to radios. If a radio receives presence signals, it stays synchronized with the gateway or the repeater which sends the signals. If a radio fails to receive a presence signal it does not immediately lose synchronization. The radio waits for another successful presence for a time defined by your service provider. This function ensures that calls are not dropped due to temporary reception issues.

If a gateway or a repeater is unavailable or the radio is not synchronized with a gateway or a repeater, depending on the setup configured by your service provider, the following scenarios apply:

- The radio falls back to Direct Mode Operation (DMO).
- After pressing the **PTT** button, a prompt appears warning that the second press overrides the gateway or repeater operation mode.
- No direct DMO calls are permitted.

In the second scenario, while the radio receives individual calls and group calls, and replying to individual calls is possible, replying to group calls is not possible.

2.22

SDS Remote Control

Short Data Service (SDS) Remote Control is a paid feature.

The SDS remote control feature enables controlling a radio through Air Interface using SDS - TL bearer service. A controlling terminal, for instance, a controlling radio or SwMI controlling terminal, sends the SDS remote control messages with AT commands to a radio for its execution.

Figure 10: SDS Remote Control Overview

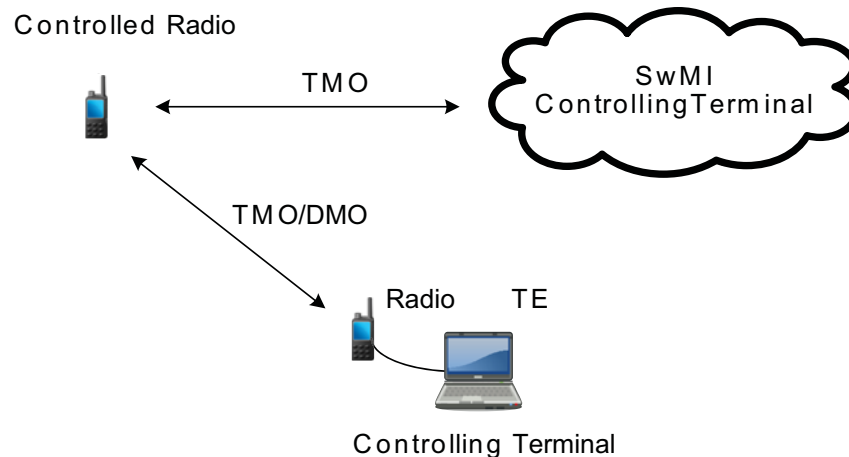

The SDS remote control functionality works in both Trunked Mode Operation (TMO) and Direct Mode Operation (DMO) and the remote control PDUs are sent using Terminal Equipment (TE).

You can use the feature only after a successful authorization, which requires entering a valid remote control PIN number.

The remote control messages can be sent to a group or individual radios.

A controlled radio receives over the air control information using SDS type 4 with Transport Layer (TL) on the specific PID number defined in the codeplug. If the received control message is originated from one of the Individual Short Subscriber Identities (ISSI) present on the radio authorized ISSI list, the radio executes received command and sends a response.

If configured by service provider upon the reception of SDS Remote Control Service (AT command) request, the radio gives an audio-visual notification.

The service provider has two options: **Limited SDS RC** and **Full SDS RC** modes.

The SDS remote control in the **Limited SDS RC** enables the following:

- Switching between TMO or DMO modes (read, change, notify) for individual radio and group using the +CTOM AT command.
- Selecting a talkgroup (read, change, notify) for individual radio and group using the +CTGS AT command.
- Reading and setting the scanning state using the +CTSCAN AT command.
- Collecting Network Information from individual radio - Network Registration Status and Cell Signal Quality using respectively the +CREG and +CSQ AT commands.
- Reading individual radio GPS position using the +GPSPOS AT command.
- Setting volume level for individual MT using the +CLVL AT command.
- Rebooting the radio using the R AT command.
- Terminating a call using the H AT command.
- Call forwarding using the +MCCFWD AT command.

The SDS remote control in the Full SDS RC enables the radio to use most of the AT Commands. To see which AT Commands are not supported, refer to the *AT Commands Programmer's Guide*.

2.23

Status Remote Control

Status Remote Control is a feature that provides limited control of the radio, unlike Short Data Service (SDS) Remote Control.



NOTICE: Only one type of remote control can be active on a radio; either SDS or Status.

The following tasks can be assigned remotely to a radio:

Play loud tone until user interaction

The radio plays a loud tone as in the Man Down feature until you unlock the keypad (if needed) and press the appropriate soft key labeled **Exit**. The tone is played through the speaker even if an accessory is attached.



NOTICE: The tone is not emitted when the radio is in one of the following states:

- In a call.
- Temporarily disabled.
- Pseudo Off Mode.
- Ambience Listening Mode.
- Transmit Inhibit Mode (TXI).
- Emergency Mode.
- Silent Emergency Mode.
- Covert Mode.

Send firmware version and TEI

The radio sends back an SDS message with its firmware version and TEI.

Send birth OPTA and TEI

The radio sends back an SDS message with its birth OPTA and TEI.



NOTICE: If the sending Individual Short Subscriber Identity (ISSI) is not on the Allowed ISSIs list, the receiving radio ignores the task.

2.24

Call-Out

Call-Out is a paid feature.

A call-out is an alert sent to one or many recipients when an incident requires immediate attention. The call-out message can include an instruction to use a different talkgroup during the call-out or remain on the attached talkgroup.

There are five types of Call-Out alerts:

Normal

An alert message sent by a dispatcher either to a single radio or to a group of radios.

Storm Plan

An alert message sent by a dispatcher to a group of radios. To raise its reliability, it is sent several times. You are not able to respond to the Call-Out alert and any key press takes you to the information phase.

Simple Call-Out

An alert with the functionality similar to full Call-Out but without the information phase. There are two types of Simple Call-Out:

- With user receipt – The Call-Out mode is ended when the acknowledgment timer runs out, or when you select **Accept**, **Reject**, **Standby**, or reply with a text message.
- Without user receipt – The Call-Out mode is ended when the acknowledgment timer runs out, or when you press any key, except for the **EMERGENCY** button, or the rotary knob.

Fallback Mode

An alert message that is limited only to voice communication. To initiate this type of Call-Out, press a One-Touch Button predefined by your service provider. It can be cleared manually.



NOTICE: Fallback is only possible when the radio is in Local Site Trunking.

Test Call-Out

A special Call-Out alert sent by the dispatcher to test this feature. On receiving the Test Call-Out, the radio plays a tone and displays **Test Call-Out**. To respond and clear the alert, press the **Test OK Soft** key.

Only the emergency mode has higher priority than the call-out. However, if your service provider configures Emergency Calls to be ignored during Call-Out mode, the radio rejects them with no notification. When you receive the alert, the following responses are available.

- **Accept** – additional information from the dispatcher is displayed.
- **Reject** – display returns to the home display and the talkgroup is set to the one before the call-out.

You can address a Call-out alert by:

- ISSI – to an individual radio.
- GSSI – to a group of recipients.

All incoming and outgoing call-out messages are stored in **CO Box** (Call-Out Box) and can be managed through the MMI. There is a two-level structure for the alerts. First level is the main alert list, and the second one are all the messages associated with the alerts. Both lists are displayed chronologically with the newest on top. The capacity of the **CO Box** is ten call-out alerts and 100 messages (incoming/outgoing). It has also the overwrite policy which deletes the oldest one upon receipt of a new call-out message. When a new call-out arrives, the new call-out overrides the old call-out (even if it has not been responded). An ongoing call-out overrides the old one in any phase of the call-out alert.

In normal mode, you can browse the **CO Box** and read all the call-out messages. In the call-out mode, you can only read the ongoing call-out messages.

The call-out service function in two main phases:

- 1 Alert Phase** – you receive the alert with the associated messages that you can respond to. These messages provide all the important information about an incident. A special tone is played when the alert is coming in. The tone volume range is configured in the codeplug and cannot be adjusted through the MMI. The conditions for stopping this tone are configured in the codeplug (for example, upon pressing any key). Also, an ongoing alert tone is paused on incoming call-out group call. This alert is resumed once the call ends (if not stopped before). The time-stamp on the Call-Out alert indicates the time and date when the Call-Out is received.
- 2 Information Phase** – you are in the call-out mode and you may receive more messages about the incident with the text or voice. You can also query for more information using the voice group call or the call-out text function which enables to send a text message to the dispatcher host application. Depending on the settings configured by your service provider, you are able to respond to a Call-Out in one of the following ways:
 - Free text – type a response.
 - Call-out template – select from a list of predefined replies.

The voice message can be sent with the high priority as a group call. You can answer back to the group or to the dispatcher using the voice group call. You may receive more info about the incident via either subsequent text or voice messages.

2.24.1 Call-Out Interactions

When you receive a call-out alert while being in the emergency mode, the message is ignored.

In the transmit inhibit mode, you can receive call-out messages. However, you cannot respond until the transmit inhibit mode is deactivated. When you decide to leave the transmit inhibit mode after viewing the message, the radio prompts to accept, standby, or reject the call-out.

The call-out feature is not supported in DMO.

In the fallback mode (that is, when you are in the local site trunking) you can receive a call-out call. In such case, the receiving radio enters the call-out fallback mode, which only includes voice communication. You can only clear the fallback mode manually.

The dispatcher can test the feature by using the call-out test. The radio then displays `Call-Out Test` and generates the alert tone. A **Soft** key is available in the MMI with the label `Test OK`. After responding to it, the display returns to the previous mode.

Storm plan alert is a special case of call-out. This alert is sent out to the larger group of people. You can respond to it with any key stroke. After responding, you proceed to the information phase. The storm plan alert is sent several times to raise reliability.

2.25 Radio Messaging System

Radio Messaging System (RMS) is a paid feature.

The Radio Messaging System (RMS) feature enables radios to receive and send RMS messages through the TETRA network using the Short Data Service (SDS), or Status Data Service (STS) Transport Layer (TL).

Figure 11: RMS Flow Model with SDS TL

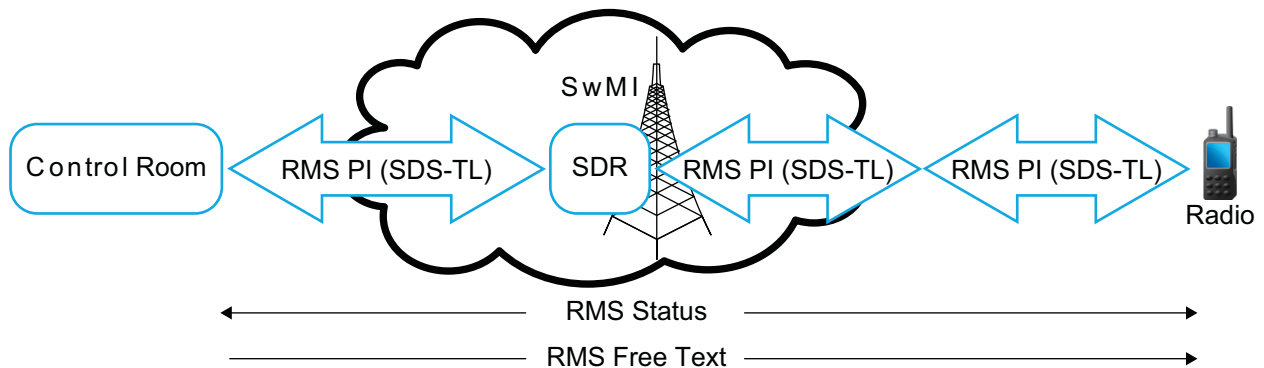

A Short Data Router (SDR) provides TETRA short data services between host applications connected to Dimetra Mobile Stations or between a host application connected to a Dimetra Mobile Station and a host application connected through the Dimetra Master Site. Furthermore the SDR provides TETRA short data services directly between two Dimetra Mobile Stations or directly between a Dimetra Mobile Station and a host application connected through the Dimetra Master Site.

Figure 12: RMS Flow Model with STS TL

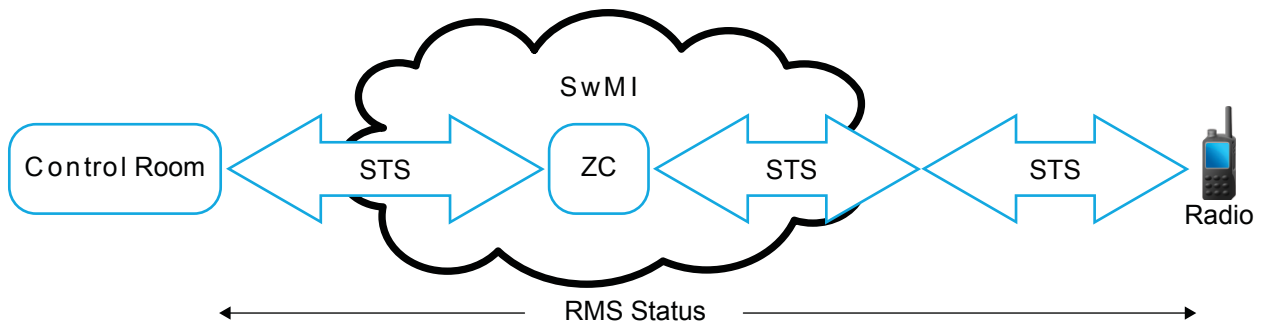

The radio is able to receive and send RMS messages, using statuses by the Zone Controller (ZC).

To receive and send RMS messages, ensure that the RMS feature is enabled in the codeplug. The radio accepts received RMS messages only from the calling party address defined in the codeplug. Any outgoing RMS status is sent to the RMS status target address defined in the codeplug.

The RMS status is a bidirectional message (from the control room to a radio and conversely). Sending an RMS status is possible, where the RMS mode is enabled in the radio. In such case, you can send one of 100 predefined RMS statuses to an address predefined in the codeplug. You can select the particular RMS status using assigned One-Touch Buttons. A received RMS status is displayed in blue color on the idle display. The latest received or sent RMS status is kept on the idle display until the next power cycle.

The RMS free text is a unidirectional message (from the control room to a radio). Received RMS free texts are displayed in blue color on the idle display. The latest RMS free text is kept on the display (idle display) until the next power cycle.

Upon receiving the request, the radio sends the latest sent RMS status to the control room without any user interaction or notification.

Incoming and outgoing RMS statuses and RMS free text messages, with the exception for RMS status sent, are stored in the **RMS Box**. The **RMS Box** has a maximum capacity of 50 entries for incoming and outgoing RMS messages. If the **RMS Box** is full, storing any new incoming or outgoing RMS message overwrites the oldest message (received or sent) in the **RMS Box**.

2.26

Global Navigation Satellite System (GNSS) Location Service

The Global Navigation Satellite System (GNSS) Location Service feature uses information from satellites orbiting the Earth to determine the geographical location of your radio. GNSS uses satellites from the GPS, GLONASS, Galileo, and BeiDou systems. GNSS Location Service is a paid feature.

The GNSS Location Service availability, accuracy, and the position calculation time vary depending on the environment in which you use the radio. The GNSS Location Service can assist your dispatcher or colleagues in many ways such as more efficient deployment of resources or locating your radio when you trigger your emergency service.

The radio supports the following system combinations depending on its hardware and configuration:

- Global Positioning System (GPS) including Satellite-Based Augmentation System (SBAS)
- Global Navigation Satellite System (GLONASS)
- BeiDou Navigation Satellite System (BDS)
- GPS + GLONASS
- GPS + BeiDou

The radio can display the location information directly on the screen or send it over-the-air to your dispatcher to display it in the control center. Check your radio configuration details with your service provider.



IMPORTANT: Where the signals from satellites are not available, the GNSS Location Service does not work. This situation usually happens when your radio cannot establish a view of a wide area of open sky, for example, when your GNSS antenna is covered or facing the ground. Such situations include being:

- In underground locations
- Inside buildings, trains, or other covered vehicles
- Under any other metal or concrete roof or structure
- Near a powerful radio or television tower
- In extreme temperature outside the operating limits of your radio

Even if your location information can be calculated in such situations, it may take longer to do so. Therefore, in any emergency situation, always report your location to your dispatcher. Where adequate signals from multiple satellites are available, your GNSS Location Service feature provides a location, most probably near to your actual location.

The radio can be triggered to send Location Reports in various circumstances, for example:

- Upon a request.
- Entering Emergency Mode.
- At specified time intervals.
- At specified distance intervals.

The Location Reports can be sent in two ways using:

- Short Data Service (SDS).
- Packet Data - Trunked Mode Operation (TMO) only.

Packet Data must be enabled on the network to send Location Reports using Packet Data. If the Location Reports are sent over the Packet Data, a Packet Data icon is displayed when the message is being sent.

If the Location Reports are sent via SDS with User-Defined Data Type-4 as a Transport Layer (SDS - TL), either the European Telecommunications Standards Institute (ETSI) Location Information Protocol (LIP) or Motorola Solutions Location Request/Response Protocol (LRRP) GPS Location Protocol is used. The LRRP GPS protocol either use SDS - TL (for added reliability) or Simple GPS with no SDS - TL (for saving air interface resources). GPS Protocol Identifiers are:

- LRRP SDS TL = 131
- LRRP Simple GPS = 3
- LIP GPS = 10

Location reports are sent in TMO. Your service provider can also provision location reports to be sent in Direct Mode Operation (DMO). If the radio is provisioned to provide user indications, the feature operational status is indicated on the radio display. Also, if configured by service provider, the radio gives an audio-visual notification upon reception of LIP command.

Depending on the radio configuration, viewing the radio position and the status of the visible satellites is available. The position may consist of longitude and latitude, UK, or Irish grid coordinates.

The GNSS Location Service feature can be enabled or disabled as a whole using the Customer Programming Software (CPS). It is possible to configure the feature parameters using the CPS, or over the air. The CPS configuration provides a default profile. The commands received over the air may overwrite the default profile configuration. The profile assigned to the radio determines when to send location data, what data to send with what accuracy and to what address. All data requests and

configuration commands received over the air are checked to confirm that they have come from a trusted source. Location reports are accepted only from authorized Individual Short Subscriber Identities (ISSI) or IPs, depending on the configured transport layer of SDS or Packet Data.



NOTICE:

The Current GPS Cycle ends between 6th and 7th April 2019 at midnight Coordinated Universal Time (UTC). After this date, your service provider must reconfigure the Current GPS Cycle codeplug value to avoid malfunctions in GPS location reporting.

Ensure that the application receiving location messages uses valid addresses which are set up on radio as an authorized ISSI range. Otherwise the radio rejects all system position requests.

You can enable or disable the GNSS Location Service through the radio interface. If this feature is disabled, the Location Service Configuration can be programmed to the following parameters:

Receiver

GNSS Receiver is disabled. The radio responds to location requests by informing that location reporting is disabled.

Receiver and Location Protocol

GNSS Receiver and Location Protocol are disabled. The radio does not respond to any location requests.

Once the GNSS Location Service is re-enabled, the radio restores its location service.

The radio supports GNSS triggers functions, using LIP or LRRP, to report GNSS positions when the radio meets a set of criteria. Your service provider can set up the following triggers, together with their specific parameters:

Table 8: GNSS Triggers

Trigger Type	Trigger Event
Power-up	Radio powers up in TMO.
Power-down	Radio powers down in TMO.
Emergency condition	Radio enters emergency operations.
Periodic	Given time interval after the last location report expires.
Moved	Radio position has changed by at least the distance defined (the radio checks the movement from the last known position at an interval).
TMO ON	Successful registration on entering TMO from DMO.
DMO ON	Before TMO deregistration, and before entering DMO.
Transmit Inhibit Mode (TXI) ON	Radio is about to enter TXI.
Transmit Inhibit Mode (TXI) OFF	Radio has successfully registered after leaving TXI.
Low battery	Radio detects its battery level has reached or fallen below the level specified by service provider.
Loss of GNSS	Radio detects a loss of GNSS for a minimum duration defined by service provider.
Recovery of GNSS	Radio detects a recovery of GNSS signal for a minimum duration defined by service provider.

Trigger Type	Trigger Event
Status entered (Status and RMS Status)	Radio sends a status defined in the codeplug for location reporting by pre-programming.
Car Kit Connected	Radio detects that a Car Kit has been connected.
Car Kit Disconnected	Radio detects that a connected Car Kit has now been disconnected.
GNSS ON	Positioning device has been switched ON.
GNSS OFF	Positioning device in the radio is switched OFF.
Emergency Periodic Profile (LRRP only)	Radio is in emergency operation and given time interval after the last location report expires.

The GNSS icon is displayed in the status area when GNSS has a location fix. Optionally, your service provider may configure the radio to always display the GNSS icon, even outside of GNSS coverage or before the radio has acquired a location fix, that is, right after being powered on. In this configuration, the GNSS icon blinks until a location fix is acquired.

2.26.1

Military Grid Reference System

Military Grid Reference System is a paid feature.

The Military Grid Reference System (MGRS) is the geocoordinate standard used by the military for locating points on Earth. The MGRS attempts to represent the entire surface of Earth on a worldwide grid. The grid is based on the UTM (Universe Transverse Mercator) between 80°S and 84°N latitudes and UPS (Universal Polar Stereographic) systems.

The UTM area is divided into 60 longitudinal strips, each 6° wide. The strips are numbered 1–60 beginning at the 180°–174° W (Zone 1) and increase to the East. Each strip (or Zone) is then divided (horizontally) into 8° latitude bands.



NOTICE: An example of an MGRS coordinate would be **19TDJ3858897366**, which consists of:

- **19** is the UTM Zone Number
- **T** is the corresponding UTM latitude band letter
- **DJ** is the MGRS Grid Reference used to define the 100 km square within the UTM/UPS block. The columns A-Z (excluding "I" and "O"), like UTM, start at 180° and increase towards the East. Every three columns, the pattern repeats. Letters designating rows, increase towards the North. The letters cycle backwards through the alphabet in the southern hemisphere (towards the South):
 - **D** is the MGRS column letter
 - **J** is the MGRS row letter
- **38588** is the 5-digit MGRS Easting value. It represents the number of meters East of the origin (that is, southwest corner) of the 100 km square in which it is contained.
- **97366** is the 5-digit MGRS Northing value. It represents the number of meters North of the origin (that is, southwest corner) of the 100 km square in which it is contained.

MGRS Support feature can be programmed in CPS. You can choose to display the GPS/GNSS coordinates in MGRS format.

2.26.2

Different Location Displays

Table 9: Different Location Displays

Latitude / Longitude	UK Coordinates	Irish Coordinates	UTM Coordinates	MGRS Coordinates
Time	Time	Time	Time	Time
Latitude	2-Letter Code	1-Letter Code	3-Letter Code	3-Letter Code and 2-Letter Code
Longitude	Easting and Northing Coordinate	Easting and Northing Coordinate	Easting and Northing Coordinate	Easting and Northing Coordinate
Altitude	Altitude	Altitude	Altitude	Altitude
Satellites	Satellites	Satellites	Satellites	Satellites

- Time - indicates when the last time the location was calculated. The time is provided in Universal Time Coordinated.
- Letter Code - grid zone or square on the map for different coordinate standard
- Latitude - expressed in degrees, minutes, and seconds.
- Longitude - expressed in degrees, minutes, and seconds.
- Number of satellites - used to calculate the location. In general, more satellites make for better accuracy. The maximum is 12 satellites.
- Easting - refers to the eastward-measured distance expressed in meters.
- Northing - refers to the northward-measured distance expressed in meters.



NOTICE: Skipping each digit of easting and northing coordinates decreases the accuracy by the factor of 10.

2.26.3

Global Navigation Satellite System (GNSS) Accuracy

The Global Navigation Satellite System (GNSS) Location Service accuracy depends on the GNSS coverage and the selected accuracy mode.

In good GNSS coverage (at least -137 dBm or in open sky), the location accuracy presents as follows:

- In high accuracy mode, the accuracy is:
 - 5 m for 50% of location reports.
 - 10 m for 95% of location reports.
- In power optimized or normal mode, the accuracy is:
 - 20 m for 50% of location reports.
 - 50 m for 95% of location reports.



NOTICE:

The presented values depend on variety of factors, for example the view on the sky. To optimize the GNSS performance the radio should have the clearest possible view of the open sky.

The use of the high capacity battery is recommended, especially when high accuracy mode is used.

2.27

Wireless Application Protocol (WAP)



NOTICE: This feature is a paid feature.

Wireless Application Protocol (WAP) is a standard for application layer network communications in a wireless communication environment such as TETRA network. The protocol is used to access the mobile web from a radio through a WAP browser.

2.27.1

WAP Browser

The Openwave Mobile Browser is a Wireless Application Protocol (WAP)-compliant user agent. The WAP browser, available only in TMO mode and on a network with Packet Data enabled, provides all the basic services of a computer web browser. Depending on the CPS configuration, the display can return to the browser session automatically after an interruption by the preemptive display. The WAP browser does not support right-to-left languages (as Arabic and Hebrew); English is used instead. The characters of right-to-left scripts are not displayed.



NOTICE: Depending on the radio configuration and the network conditions, the WAP browser may not display images properly (or may display them with a delay).

2.27.2

WAP Push



NOTICE: This feature is a paid feature.

Wireless Application Protocol (WAP) Push allows WAP content to be pushed to a radio. This push is carried out by sending a specially formatted (Push Access Protocol) XML document to the Push Proxy Gateway, that in turn forwards the document to the radio.

A WAP push message is an encoded message including a link to a WAP address. When receiving a WAP push, a WAP enabled radio automatically gives the option to access the WAP content. The implemented WAP push is compliant with WAP 2.0 standard.

The radio supports WAP 2.0 through a proxy only. Proxyless connections are not supported.

2.28

Radio User Assignment and Radio User Identity

Radio User Assignment (RUA)/Radio User Identity (RUI) is a paid feature.

Radio User Assignment (RUA) and Radio User Identity (RUI) enables authentication for providing full access to the infrastructure and the physical radio.

Where the RUI feature is enabled, on logging on to the radio you enter your User ID with the PIN to check your identity. Only the successful logon provides the full access. A logon failure results in limited service.

Where also the RUA feature is enabled, after successful RUA/RUI authentication you are logged on to the physical radio. Thus, you can still be reached at your radio number.

You can differentiate the RUA/RUI state by the interface color. Blue for logged on and gray for logged off. No additional icon indicates whether you are logged on.

Besides the logged on off states, the radio can also be in the pseudo logon state indicated by the relevant icon.

The User ID is stored in the RUI List. To verify who is logged on to the radio, see the second line in the RUI list (the first line is **New User ID**).

2.28.1

RUA/RUI Log On

You can log on yourself or the dispatcher can log you on. The feature must be enabled in the codeplug, by your service provider.

After turning on the radio, the infrastructure verifies a request from the radio and checks if it supports the Radio User Assignment (RUA)/Radio User Identity (RUI). When the infrastructure accepts RUA request, you are asked for RUI and RU-PIN. After providing correct information, a successful logon occurs and full access is granted for specified time.

When a RUI and/or RU-PIN are incorrect, a logon failure occurs. The infrastructure sends the RUA reject signal to the radio. If enabled in the codeplug, limited service access is granted.

When the dispatcher is sending the RUA accept signal to the radio with the time period that the full service is granted, then the successful book on occurs.

2.28.2

RUA/RUI Radio Behavior

When the radio is logged off and receives RUA accept from the infrastructure without sending logon information, it indicates book on with an assigned logon period timer. The radio sends automatically book on response according to the terminal settings: **Book on Reject** – the radio rejects all the book on, **Book on Accept** – the radio accepts all the book on.

To log off, use the radio menu. The dispatcher has also the option to log you off using **Force Off** setting.

The pseudo logon is a state which occurs when the RUA/RUI authenticated radio goes to LST, or infrastructure accepts the logon with the empty granted assignment period. In this state, the radio has the full functionality available except some services as forwarding calls. This state is signaled with a specific icon.

The RUA/RUI feature is specified with the following timers:

- Logon Process Timer – defines the amount of time during which the radio awaits log on response from infrastructure.
- Time Out Warning Timer – defines the amount of time after which the radio displays the warning.
- Logon Period Timer – defines the amount of time during which the radio is logged on.

2.28.3

RUA/RUI Interactions

When you switch from TMO to DMO, the terminal logs off (depending on the codeplug settings). When you switch from DMO to TMO, the radio initiates the logon process.

You may be RUI-authenticated when out of coverage. In this situation, the radio is in pseudo logged on status. All the timers are the same as for the logged on user with the coverage. You may also be logged off when out of coverage. In this situation, the radio is provided with the limited service access.

In both cases, if the radio is back in the coverage area and receives RUA request from SwMI, it prompts you to log on.

If during the emergency operations you receive the force-off, it logs you off without exiting the emergency operations. As long as the radio is in the emergency operations, the radio display does not indicate any change.

When the radio turns on in the LST, it prompts for the PIN. If the correct PIN is entered, the radio switches to the pseudo logged on state. When you move to the LST, the radio switches to pseudo logged on state. However, no prompt for the PIN occurs.

When you change to a different physical terminal, the store and forward report is routed to the radio where you are currently logged on. When the radio receives store and forward report, it does not display the report, as the reports have to match the sent SDS. If an SDS consumer report is requested, it is recommended that the receiver sends an explicit separate SDS message to confirm that the message has been received and read. The report is stored together with the sent SDS in the **Outbox**, because of that when you log off, delete the messages from the **Outbox**. When you change to different physical radio, the previous permanent radio does not receive the report. The status of store and forward message in the **Outbox** cannot be updated.

Chapter 3

Man-Machine Interface

3.1

LED Indications

Table 10: LED Status Indications

Indication	Status
Solid green	<ul style="list-style-type: none"> In use. Repeating call.
Blinking green	<ul style="list-style-type: none"> In service or idle.
Solid red	<ul style="list-style-type: none"> Out of service. Switching between modes, for example, DMO to TMO.
Blinking red	<ul style="list-style-type: none"> Connecting to the network. Entering DMO.
Solid orange	<ul style="list-style-type: none"> Radio is powering up. Transmit inhibit in service. Channel busy in DMO. Radio interference in DMO.
Blinking orange	<ul style="list-style-type: none"> Incoming call.
No indication	<ul style="list-style-type: none"> Radio powered down. Radio in Covert Mode.

3.2

Battery Charging Indications

When the radio is turned on while charging, it displays an icon of the battery in charging.

When the radio is turned off while charging, it displays the icon of the battery in charging and backlights the display.



NOTICE: To easily identify the charging status, check the Battery Charging LED Indicator. See [LED Indications on page 87](#).

Table 11: Battery Icons

Battery Capacity				Battery Charge Progress			
Empty	Low	Middle	Full	Empty	Low	Middle	Full

Battery Capacity				Battery Charge Progress			
5%–10%	10%– 20%	20%– 90%	90%– 100%	5%–10%	10%– 20%	20%– 90%	90%– 100%

3.3 Controls and Indicators

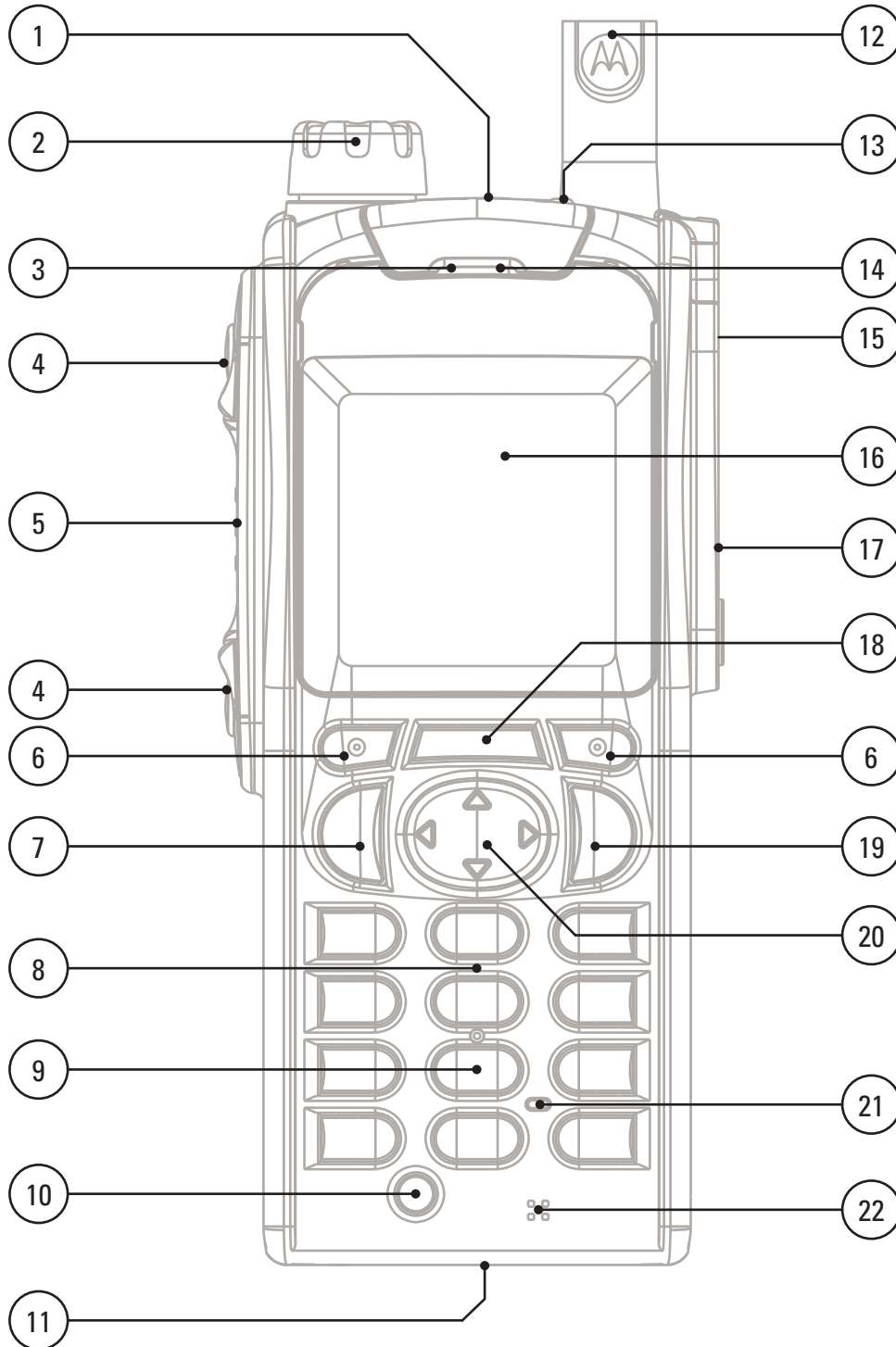





Table 12: Controls and Indicators

Annotation	Description
1	<p>Emergency button Press and hold Emergency button to enter Emergency operation. When your radio is off, press and hold to power on in Emergency Mode.</p>
2	<p>Rotary Knob</p> <ul style="list-style-type: none"> • Rotate to set the volume. • Press and rotate to select a different talkgroup. • Press and hold the Rotary Knob to lock/unlock it. Powering off also unlocks a locked Rotary Knob.
3	Earpiece
4	<p>Side button The Rotary Knob and Side buttons programming are paired. When the Rotary Knob is set to Volume or Dual, the Side buttons support the One-Touch Button feature. By default, the upper Side button is set to Backlight feature and the lower Side button is set to Screen Saver feature.</p> <p> NOTICE: The required time to press and hold Side button to activate a One-Touch Button feature is set as default to 0,1 second.</p>
5	<p>Push-To-Talk (PTT)</p> <ul style="list-style-type: none"> • Press and hold to talk in simplex calls or to initiate a group call, release it to listen. • Press to send status and text messages.
6	<p>Soft key Press Left or Right Soft key, to select the option that appears on the screen directly above the them.</p>
7	<p>Send key Press to initiate or answer duplex calls, or send messages.</p>
8	Speaker
9	<p>Keypad Use the Keypad to enter alphanumeric characters for dialing, contact entries, and text messages.</p> <p>Your radio supports the One-Touch Button feature that allows you to activate commonly used features by pressing and holding assigned key (0-9, * and #).</p> <p> NOTICE: The required time to press and hold assigned key to activate a one-touch feature is set as default to 1 second.</p>
10	<p>Speaker Control key Press the Speaker Control key to activate the earpiece Speaker LOW or speaker Speaker HIGH.</p> <p> NOTICE: In an Emergency Group Call, the speaker is activated regardless of the speaker setting.</p>
11	Accessory Connector

Annotation	Description
	Provides connection for accessories and cable for data transfer.
12	Antenna
13	LED
14	Top Microphone Activated during Simplex, high audio calls such as Group Calls.
15	External Antenna Connector Used with the digital car kit to connect the RF signal to the external antenna.
16	Display Provides alphanumeric text and images within 65,536 colors and 130 x 130 pixels with backlight, scalable fonts, and contrast.
17	Side Connector Used to connect accessories and for programming.
18	Menu key <ul style="list-style-type: none">• From the home screen, press to enter the main menu.• Used to enter the context-sensitive menu.
19	On/Off/End/Home key <ul style="list-style-type: none">• Press and hold to turn on/off your radio.• Press to end calls.• Press to return to the home screen.
20	Navigation key Press Up , Down , Left or Right Navigation key for list scrolling, while moving around the menu hierarchy, or for alphanumeric text editing. From the home screen, press to activate one of the following: <ul style="list-style-type: none">• Down Navigation key – enters Recent Calls menu item.• Up Navigation key – changes My Groups talkgroup folder.• Left and Right Navigation key – toggles through the talkgroups.
21	Backlight Sensor
22	Bottom Microphone



NOTICE: A detailed list of compatible accessories is included in *Accessory Leaflet*, part number: 68015000559. To obtain the document, contact your service provider.

3.4

Keypad Lock

You can lock the keypad to prevent accidental pressing of keys by pressing **Menu** → *. The keypad lock can be invoked using the menu or predefined menu shortcut.

By default, while the keypad is locked, all front and side keys including **PTT** are inoperative except for the **On-Off** and **Emergency** buttons. When an incoming emergency call is received, the **PTT** button automatically unlocks for the call duration.

You can set the **PTT** button behavior in the codeplug to the following options:

- **Disable**: disables Lock PTT feature on all PTTs.
- **Enable - All**: locks all PTTs.
- **Enable - Radio with RSM**: locks radio PTT only, specifically when a Remote Speaker Microphone (RSM) is connected.
- **Enable - Accessories Only**: locks RSM PTT only.



NOTICE: Selecting **Enable - Accessories Only** does not lock or affect the Bluetooth PTT.

When the keypad is locked, one of the following is displayed:

- **Nothing** - no notification is displayed.
- **Notification Only** - `Keys Locked` is displayed.
- **Notification and Instruction** - `Press Menu and * to Unlock` is displayed.

You can set the display option in the codeplug. By default, it is set to **Notification and Instruction**.

3.5

Automatic Keypad Lock

The automatic keypad lock is a feature enabling the radio to lock its keypad automatically after a defined period. The radio allows activating or deactivating the feature using the MMI. If the feature is enabled, after a defined time of inactivity the keypad locks automatically. Any user activity restarts the **Automatic Keypad Lock** timer. When the keypad locks automatically, the following notification is displayed **Keypad auto locked**. You can change the time value required for the automatic lock through the MMI.

3.6

One-Touch Buttons

The One-Touch Button feature allows you to activate a feature by a long key press of the programmable button. Your service provider can assign one-touch functions only to the side buttons and keypad keys. If an unassigned button is pressed, the radio displays `Unassigned Button`.



NOTICE:

You can also assign features to the option buttons of the RSM accessories.

The One-Touch Button and One-Touch Dial are mutually exclusive features.

Table 13: One-Touch Button Features

Feature	Description
Activation of Covert Mode	Turns Covert Mode on or off.
Change Audio Profile	Change to the specific audio profile.
Change Talkgroup	Changes the talkgroup to the one programmed by your service provider.
Display Operative Tactical Address (OPTA)	Displays the Operative Tactical Address (OPTA).
DMO Pre-emptive SDS	Sends the next DMO SDS or status message with elevated priority.
Flip Display	Rotates the display by 180 °.
Inactive One Touch Key 0	The one-touch function assigned to the 0 key remains inactive until you invoke the function by two long key presses on the button.

Feature	Description
	 NOTICE: A single long key press on the 0 button will instead call out the + symbol.
Initiate Call-Out Fallback	Sends Call-Out Fallback Alert.
LIP Report	Sends a message with the location of the radio to a dedicated address.
PABX Call Setup	Initiates a PABX call to a predefined entry in the contact list.
Phone Call Setup	Initiates a phone call to a predefined entry in the contact list.
Private Call Setup	Initiates a simplex or duplex private call to a predefined entry in the contact list or to the last group call originator.
Reset to Default	Resets the radio to its default settings.
RMS MMI Menu	Opens the RMS menu without activating RMS mode.
RMS Mode Activation or Deactivation	Toggles RMS feature on or off.
RUI Logon or Logoff	Asks for the credential or logs off the radio.
Selecting Audio Profiles	Scrolls through all available audio profiles.
Send Double Push PTT Tone (D-PTT)	Sends the D-PTT tone to the currently used talkgroup.
Send Predefined Template (PDT)	Sends a predefined message to a dedicated address.
Send Status Message	Sends a dedicated status message to a dedicated address.
Send User-Defined Template (UDT)	Sends a user-defined message to a dedicated address.
Speaker Enable or Disable per Call	Enables or disables the loudspeaker for a duration of the ongoing call.
Switch to Previously Selected Talkgroup	Changes the talkgroup of the radio to the previously selected talkgroup (DMO or TMO).
Timed Talkgroup Change	<p>Makes a predefined talkgroup the selected talkgroup for a specified amount of time. While using the predefined talkgroup, the second press of the One-Touch Button results in:</p> <ul style="list-style-type: none"> • the radio returning to the previously selected talkgroup, • the radio restarting the predefined time, or • no action on the radio, depending on the configuration <p>After the timer expires, the radio returns to the previously selected talkgroup.</p>
Toggle Backlight	Toggles the backlight on or off.
Toggle BSI Encryption Enabled or Disabled	Enables or disables BSI encryption.
Toggle DMO or TMO	Toggles between TMO and DMO modes.
Toggle Extra Zoom	Turns Extra Zoom on or off.
Toggle Hi or Low Audio	Toggles audio high or low.

Feature	Description
Toggle Howling Suppression	Enables or disables Howling Suppression.
Toggle Man Down On or Off	Turns Man Down feature on or off.
Toggle RF Power Class	Toggles the RF Power Class between High and Normal.
Toggle RSM with Earpiece	Activates or deactivates the RSM earpiece.
Toggle Screen Saver	Activates or deactivates the Screen Saver feature.
Toggle Talkgroup Scan	Turns the Talkgroup Scan feature in TMO Mode on or off.
Toggle Transmit Inhibit Mode (TXI)	Turns Transmit Inhibit Mode on or off.
Turn Repeater Mode On or Off	Turns Repeater Mode on or off.
Unassigned	No feature assigned to this button.
Universal Time Display	Displays universal time on the home screen.
Volume Down	Press to decrease the volume by one level. Press and hold to continuously decrease the volume to its minimum level.
Volume Up	Press to increase the volume by one level. Press and hold to continuously increase the volume to its maximum level.

3.7

Display

This section presents the default home screen elements of the radio.

Figure 13: Default Home Screen with Icons

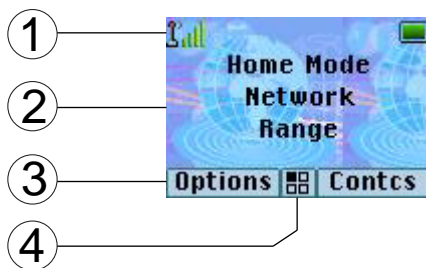

Table 14: Display

Annotation	Description
1	Status icon area
2	Text display area
3	Soft key area
4	Menu/Context sensitive icon

The color of the Soft key area changes according to the mode the radio is in.

Table 15: Colors of the Soft Key Area

Color	Mode or State
Light blue	Normal TMO and DMO Modes
Light red	Emergency Mode or Disaster Alert Call
Olive	Local Site Trunking Mode
Yellow	Call Out – Standby
Red	Call Out – Alert
Green	Call Out – Accepted
Blue	Radio Messaging Service (RMS)
Gray	Radio User Assignment (RUA) – Limited service









3.7.1















Status Icons

















Status icons appear when your radio is engaged in certain activities or when you have activated certain features.











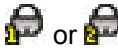

The icons can appear in normal or large size. To manually enable/disable large status icons, go to **Menu** → **Setup** → **Display** → **Extended Status Icons**.

Table 16: Status Icons

Icon	Description
Trunked Mode Operation	
	In Service
	No Service
	Signal Strength – The more bars, the stronger the signal.
	RF Power – Indicates the High RF Power is enabled. Shows the signal strength. The more bars, the stronger the signal.
	Migration – Indicates that the radio is registered to a foreign network.
	Broadcast Call – Indicates that the radio is in a Broadcast Call.
	Scan – Indicates that talkgroup scanning is activated in the radio.
	Data Connected – Indicates that data connection is idle (standby).
	Data Transmit/Receive – Indicates that active data connection. Number 1, 2, 3, or 4 indicates how much bandwidth is used during transmission (25%, 50%, 75%, or 100%).
Direct Mode Operation	

Icon	Description
	Direct Mode Call – Indicates that the radio is receiving a Direct Mode call. The more bars, the stronger the signal.
	High RF Power: idle or transmitting – Indicates High RF Power option is enabled and the radio is either in idle mode or is transmitting a call.
	High RF Power: receiving – Indicates High RF Power option is enabled and the radio is receiving a call.
	Direct Mode – Indicates that radio is in Direct Mode (radio-to-radio communication).
	Repeater Mode – Indicates that radio is operating as a repeater in Repeater Mode.
	DMO Gateway Communication Mode – Indicates that gateway is selected. The icon has the following status: <ul style="list-style-type: none"> • Solid – when the radio is synchronized with the gateway. • Blinking – when the radio is not synchronized or during attachment. • No icon – during radio to radio and repeater call.
	DMO Repeater Communication Mode – Indicates that the Repeater or GW + Rep option in DMO Mode is selected. The icon has the following status: <ul style="list-style-type: none"> • Solid – when the radio has detected the repeater (for example when the radio receives a presence signal). • Blinking – when the radio has not detected the repeater or during attachment. • No icon – during a radio to radio and gateway call.
General Icons	
	All Tones Off – Indicates that: <ul style="list-style-type: none"> • Volume is set to 0 (when Volume Adj. Mode is set to Common). • Both simplex and duplex ring volume is set to 0 (when Volume Adj. Mode is set to Individual).
	Simplex Ring Muted – Indicates that simplex ring volume is set to 0 and duplex ring volume is set to more than 0.
	Duplex Ring Muted – Indicates that duplex ring volume is set to 0 and simplex ring volume is set to more than 0.
	Vibrate Only – Indicates that the radio vibrates to alert you of an incoming call.
	Vibrate then Ring – Indicates that the radio vibrates and then rings to alert you of an incoming call.
	Low Audio – Indicates that the audio mode is changed to low.
	High Audio – Indicates that the audio mode is changed to high.

Icon	Description
	Audio Profile Selected – Indicates that an audio profile associated with a particular icon is active. The icons can be either solid or blinking. For details on audio profiles available on the radio, contact your service provider.
	Earpiece Connected – Indicates that the earpiece is connected.
	GPS Icon <ul style="list-style-type: none"> • Solid – the radio has a location fix. • Blinking – the radio is acquiring a location fix. This is an optional setting and may not be enabled on your radio.
	RUI Logged on – Indicates that you are logged on into the radio.
	RUI Pseudo Log On – Indicates that you are in pseudo logged on state.
	RUI Packet Data – Indicates Pseudo Log On state when the Packet Data feature is activated and active data session is in progress.
	RUI Packet Data – Indicates Pseudo Log On state when the Packet Data feature is activated and the external device sets up data connection with the radio.
	Battery Strength – Shows the charge of your battery.
	Battery Charging – Indicates that the battery is charging.
	Emergency – Indicates that the radio is in Emergency Operation. <ul style="list-style-type: none"> • Solid – Emergency Operations initiated. • Blinking – the radio is in emergency receiving state.
	Disaster Alert Call – Indicates that the radio is in Disaster Alert Call.
	List Scrolling – Indicates that the Rotary Knob is in list scrolling mode.
	New Message Has Arrived – Indicates that a new message has arrived.
	New Message(s) in Inbox – Indicates that you have unread messages in your In-box .
	Unread (New) WAP Message – Indicates that new page was loaded to the browser.
	Man Down Active – Indicates that the Man Down feature is active.
	Man Down Alert – Indicates that the Man Down feature is active. This icon has the following status: <ul style="list-style-type: none"> • Blinking – pre-Alert; the radio signals Man Down conditions. To exit the pre-Alert state, change the conditions or press the PTT button. • Solid – the radio enters Alert mode.

Icon	Description
	Man Down Failure – Indicates that the Man Down device failed.
	<p>End-to-End Encryption (E2EE)</p> <p>Solid, when the E2EE is enabled:</p> <ul style="list-style-type: none"> • for the selected talkgroup, • for the highlighted private number, • for the manually entered private number, • when transmitting voice in Group Calls, • when transmitting voice in Simplex Private Calls. <p>Blinking, when the E2EE is enabled:</p> <ul style="list-style-type: none"> • when receiving voice in Group Calls, • when receiving voice in Simplex Private Calls, • during encrypted Duplex Private Calls.
	<p>Encryption Off</p> <p>Blinking – Indicates that the SIM Card End-to-End Encryption is disabled in DMO and TMO Modes.</p>
	<p>SIM End-to-End Encryption (E2EE)</p> <p>Solid – Indicates that the SIM Card E2EE is enabled in TMO Mode.</p>
	<p>SIM End-to-End Encryption (E2EE)</p> <p>Solid – Indicates that the SIM Card E2EE is enabled in DMO Mode. Numbers 1 and 2 point to the type of DMO Encryption keys that has been selected.</p>
	<p>Unread (New) WAP Message – Indicates that you have not entered WAP Box since last WAP message was received.</p> <p>Blinks when the priority is high.</p>
	<p>WAP Message Icon – Displayed next to the priority WAP message in the message list view.</p>
	<p>WAP Message Time – Displayed next to the create date in the message list view.</p>
	<p>WAP Message Expiration – Displayed next to the expiry date in the message list view.</p>
	<p>WAP Message Title Icon – Displayed next to the title along with the text in the message list view.</p>
	<p>Keys Locked – Indicates that keys are locked.</p>
	<p>Non-Secured Call – Air Encryption Unavailable</p> <p>Blinking – Indicates that Air Encryption is not available when the radio:</p> <ul style="list-style-type: none"> • is in the Local Site Trunking Mode. • attempts to connect to a gateway.
	<p>Non-Secured Call – Air Encryption Unavailable</p>



Icon	Description
	Blinking – Indicates that Air Encryption is not available in DMO Mode. The icon appears after the PTT button is pressed.
	Remote Control – Indicates that the radio is being remotely controlled and some commands are being executed in the background. For example, when the radio is being controlled by special SDS messages or triggered to send a GPS location report. Icon is not visible in Extra Zoom Mode.

3.7.2

Idle Display

The terminals provide access to all services from the main idle display.

Your service provider can configure the idle display. The idle display can show the following:

- Icons on the status area (top line):
 - Status icons in Trunked Mode Operation (TMO) signal level icon.
 - Battery level displayed at all times.
-  **NOTICE:** The terminal periodically repeats the audible and visible indication of low battery.
- In default configuration non-BSI radio in TMO displays:
 - Line 1: Network status or network identification (No Service or MCC/MNC or MCC/MNC Alias).
 - Line 2: Selected Group Folder.
 - Line 3: Selected Group.
 - Lines 4, 5: Home Mode Display Text (if available).
 - Line 5: Time and Date (if available).
-  **NOTICE:** In case the time and date information for a specific language cannot be displayed in one line in the zoom or standard mode, the information is displayed in two lines. The time and date overwrite the second line of Home Mode Display if any.
- Soft key labels and optional menu icon.
- An optional wallpaper background.

From the idle display, you have easy access to stored target lists:

- Pressing the **Up** key accesses the favorite talkgroups list.
- Pressing the **Down** key accesses the recent calls lists.
- Pressing the **Send** key accesses the last dialed numbers list.
- Pressing the **Contcs** softkey accesses the address book.

3.7.3

Configurable Idle Screen

Your service provider can configure the information that is displayed on the idle screen below the status icon area. Depending on the radio configuration and services supported, the following information can be displayed:

- Radio Status

- Audio profile name
- Network alias (No Service or MCC/MNC or Networks Alias)
- Range alias
- Talkgroup alias
- Home mode display
- Time and date
- RMS/FMS
- ISSI
- Operative Tactical Address (OPTA)
- BSI Registration status

Order and visibility of these items are also subject of the Configurable Idle Screen settings.

3.7.4

Display Features

The radio utilizes colors to highlight certain special situations:

- When the radio is in an emergency mode/call.
- When in the call-out mode (alert received state, standby state, accept the state).
- In the RUA/RUI, when you are logged on or pseudo logged on.

If the display flip is provisioned, the radio can reverse the direction of the display. Hence, the display can be read when holding the radio upside down.

The radio has two font size levels that you can choose using the menu.

The backlight can be provisioned to operate in one of the following modes:

- Disabled – The backlight does not operate at all.
- Semi-Auto – Pressing a provisioned One-Touch Button toggles the on/off state of the backlight. The backlight is also turned off automatically when the backlight timer runs out.
- Auto – Pressing any key automatically turns on the backlight.

The backlight remains on until the backlight timer runs out, or if a provisioned One-Touch Button is pressed to turn it off. You can also toggle between the modes using the menu.

The radio supports an option to display a screen saver when the radio has been idle for a set time, or when you explicitly activate it. The screen saver consists of an image, which can be provisioned from any GIF image, and a text string which can also be provisioned. When the screen saver is being displayed, any key input or incoming service causes the screen saver to deactivate.

3.7.5

Languages Supported

Table 17: Languages Supported

Language	MTP850 FuG
English	Yes
Arabic	Yes
Chinese (simplified)	Yes
Chinese (traditional)	Yes

Language	MTP850 FuG
Croatian	Yes
Danish	Yes
Dutch	Yes
French	Yes
German	Yes
Hebrew	Yes
Hungarian	Yes
Italian	Yes
Korean	Yes
Norwegian	Yes
Portuguese	Yes
Polish	Yes
Russian	Yes
Latin American Spanish	Yes
European Spanish	Yes
Swedish	Yes
User defined	Yes

3.8

Tones

Table 18: Radio Tones

Tone Name	Default Tone Diagram
Back to Coverage Back to Full Service	
Clear-to-send	
Bad Key Pressed	
From Out-of-Service to In Service	

Tone Name	Default Tone Diagram
In Emergency	
Talk Permit	
<ul style="list-style-type: none"> • Talk prohibit • System busy • Time-out timer expire • Called radio not available or busy 	
Call Disconnected or Failed Due to Network	
Toggling Between DMO and TMO	
Entering/Exiting Local Site Trunking	
Receiving/Sending Emergency Alarm	
Emergency Alarm Failed	
Entering Emergency	
Exiting Emergency	
Entering/Exiting TXI	

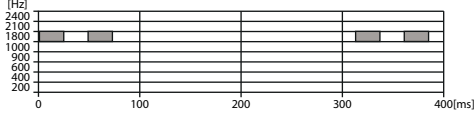
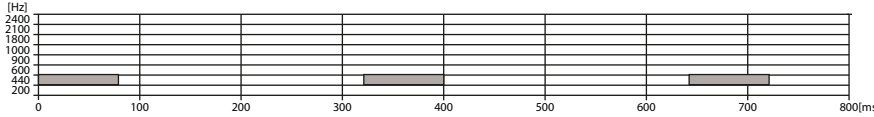
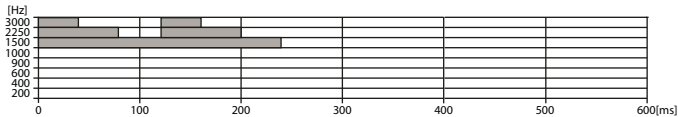
Tone Name	Default Tone Diagram
Low Battery Alert	
BSI Key Negotiation	
Remote Control	



NOTICE: Your service provider can disable all the audible indications.

3.9

Dual Microphones

Each radio has two microphones. One at the top of the unit for dispatch (simplex) operation, and another at the bottom of the unit for duplex calls.

While the ambience listening is active or while being in the covert mode, you cannot switch to the high audio mode by pressing the speaker control key.

3.10

Audio Toggle

You can control audio routing between the speaker and earpiece for any private or group call through the dedicated **Speaker Control** key. You can also define through the menu to have all group calls in high audio or controlled by the **Speaker Control** key.

3.11

Volume Adjustment Mode

You can set the volume to Individual or Common. When it is set to Individual, the volume level for Voice, Duplex, Simplex, Earpiece, Speaker, and Keypad can be set per user preferences. When set to Common, the audio has one setting for all items. The Volume Control Mode is configurable using the Customer Programming Software (CPS).

3.12

Accessory Setup

You can connect IMPRES, CORE, Other, or Secondary accessories to the radio side connector.

If you connect an IMPRES accessory, the radio detects and recognizes the accessory automatically. If you connect a CORE, Other (for example, a third-party accessory), or Secondary accessory (for example, an earpiece connected to an RSM), the radio may detect the connection but manual selection is required at the **Accry Setup** menu.

The **Accry Setup** menu contains the supported accessories, represented by their Model Number as defined by the related Audio Device Descriptor (ADD). ADD is a set of parameters in the radio that defines the audio settings, such as gains and filters settings, for each accessory.



IMPORTANT: Do not connect RSMs to both connectors at the same time. To ensure correct connection, do not press any RSM buttons when connecting the RSM to the radio.

3.13

Audio Features

Different audio quality and adaptive audio parameters can be configured according to the working environment.

There are many situations where the demand of audio quality changes according to the working environment. For example, an airport worker, who works partly in the field where there is lots of noise coming from the surrounding environment and partly inside the airport where there is relatively less noise, may experience different audio quality.

3.13.1

Audio Profiles

Audio profiles provide an easy way to adjust audio settings to match existing working conditions, such as high noise environments.

The Audio Profiles determines the following settings:

- Volume Settings for Voice and Tones
- Mic Gain
- Voice Filters such as AGX and noise suppressor
- The type of audio icon to use: yellow [default], red, blue, green, or brown; solid or blinking.

One audio profile is enabled by default but up to ten audio profiles can be enabled, the names of which are configurable by CPS. The audio profiles are based on templates, which are provided by Motorola Solutions and are also managed by the CPS. Several audio profiles can be created, based on the same template.

Audio profiles can be selected by navigating through the radio menu or by selecting a pre-programmed One-Touch Button.

The name of the active audio profile can optionally be displayed on the idle screen. This is part of the Configurable Idle Screen feature.

3.13.2

Audio Templates Names and Availability

Table 19: Available Audio Templates

Template Name	Description
Standard	This audio template gives a compromise for indoor usage with low to moderate ambient noise and outdoor usage with higher ambient noise levels. The template uses extended TX AGC (from -15 dB to +8 dB). This audio template can be used for sound pressure levels in the range of 60 dBSPL to 80 dBSPL.
General Purpose	This audio template should be chosen when the radio is used in a moderate ambient noise environment where the sound pressure level is less than 79 dBSPL(C). Example: The day to day indoor and moderate noisy outdoor environment.

Template Name	Description
Indoor	This audio template should be chosen when the radio is used in the quiet indoor environment where the ambient sound pressure level is less than 65 dBSPL(C). Example: A business office environment.
Outdoor, Harsh type 1	This audio template should be chosen when the radio is used in a harsh noise environment where sound pressure level is around 89 dBSPL(C). This template provides a compromise between loudness and howling distance. Example: Loud outdoor noise environment.
Outdoor, Harsh type 2	This audio template should be chosen when the radio is used in a harsh noise environment where sound pressure level is around 89 dBSPL(C). This template is optimized with respect to loudness at an expense of howling distance. Example: Port, airport, energy plant, and other environments
Outdoor, Street use	This audio template should be chosen when the radio is used in a noisy street environment where the ambient sound pressure level is around 85 dBSPL(C). Example: Traffic noise environment
Extended Gen Use 1	This audio template is similar to the General purpose template, but the extended TX AGC (from -15dB to +8 dB) is used instead of the normal TX AGC (from -7 dB to +8 dB). This audio template should be chosen when there is greater variance in the ambient noise levels of the environment. Example: Shopping malls, train stations, outdoor environments with moderate ambient noise.



NOTICE:

Audio template **Extended Gen Use 1** uses the extended TX AGC range (from -15 dB to + 8 dB), whereas the remaining audio templates use the existing TX AGC range (from -7 dB to +8 dB). When you select a profile based on these audio templates, the radio uses the extended TX AGC range. When you switch to any other profile, the radio uses the corresponding TX AGC range.

You can modify an audio profile by changing some of the audio parameters in the codeplug to modify an audio profile. The subjects to the change are for example: Mic Gain, Speech Volume, AGC, Voice Filters, and Alert Tones Volume. The full list of the parameters specific to particular radio is available in the **Audio Parameters** node of the corresponding audio profile.

3.13.3

Transmit Automatic Gain Control

The Transmit Automatic Gain Control (TX-AGC) provides flexibility in terms of operating environment. The TX-AGC allows you to transmit from a radio both indoor and outdoor without having to change a profile. The TX-AGC provides normalized sound levels to the receiving party.

3.13.4

Howling Suppression

The howling suppression is a mode increasing the stability of the acoustic feedback loop. To enable this anti-howling function use the menu or the corresponding One-Touch Button. The radio eliminates howling caused by the feedback loop from the receiving radios to the sending radio in simplex calls.

When the howling suppression is enabled, Microphone and Speaker gain reduction values corresponding to the active audio profile are taken into use.

You can toggle the howling suppression during an active call.

3.14

Test Page

Only authorized persons can use the Test Page option and this option must be enabled in the codeplug.



NOTICE: If Test Page option is not enabled in the codeplug, you can only access the Key Variable Loader (KVL) mode option. When using a KVL device (a portable device used to load encryption keys to a secure entity), set the baud rate to 19200 bits/second.

Use the following key sequence to access the test page: * → # → **Menu** → **Right**.

The following information is available in the test page.

- **Ver Info** – Version Information – displays software or hardware version information.
 - **Build Date** – software build (a compiled version of software).
 - **CP Ver** – Codeplug version.
 - **DSP Ver** – Signaling Processor Software version.
 - **Host Ver** – Application Software version.
 - **HardwareID** – hardware identification number.
 - **EquipID** – TETRA Equipment Identity (TEI).
 - **LLS version** – Local Language Package version.
- **Addresses;**
 - **Home MNI** – country identification code, network code.
 - **Group ID** – number of the currently selected talkgroup.
 - **Own ISSI** – Own Individual Short Subscriber Identity.
 - **ASSI** – Alias Short Subscriber Identity.
- **Err Logs** – Error Logs – displays information about software errors.
- **Cells Info** – Cell Information – displays information about the foreground and background cells (BTS sites). This menu displays the RSSI levels of the cells.
- **Cell Lists** – Displays frequency lists.
 - Frequency **List1** (32 variable frequencies)
 - Frequency **List2** (32 fixed frequencies)
 - Frequency **List3** (comprehensive hunt)
 - Frequency **List4** (comprehensive hunt)
- **Data Svc** – Data Services – allows access to the air tracer enable, the conformance tests, and the KVL mode.
 - **Air Tracer**
 - **Conf Test** – Conform test.
 - **KVL Mode**
 -  **NOTICE:** The display is dark and empty in KVL mode. However, the green LED is on. During data exchange with the AIE KVL, the orange LED is on. On successful key exchange, the green LED is on again. In any error situation, the red LED is on. You can leave the KVL mode by pressing the power button.
 - **E2E Key Del**
 - **MS Logging**
- **CE Monitor** – Circulator Eliminator Monitor.

- **Key Info** – Key Information allows the radio to display security information for the following conditions:
 - For the serving cell:
 - + **Curr Cell SC** – Security class of the serving cell, that is Security Class 1, Security Class 2, Security Class 3, Security Class 3 with Group Cipher Key (GCK).
 - For the group OTAR:
 - + **CMG GSSI** – Crypto-Management Group (CMG) group of MSs with common key material
 - For SDMO and TM-SCK OTAR:
 - + **SCK SubsGrType** – SDMO SCK Subset Grouping Type.
 - + **Curr Subs Info** – current SDMO SCK Subset Number and SCK-VN.
 - + **Fallback TMSCK** – current Fallback TMO SCK, that is SCKN and SCK-VN attributes.
 - + **SCK List** – list all SCKs stored in the radio, that is SCKN and SCK-VN attributes (SCK version number).
 -  **NOTICE:** When checking for SDMO key information in the radio, the SDMO KAG (SDMO Key Association Group) range in the AuC (Authentication Center) is from 0 to 9 and the range in the radio is from 1 to 10.
 - For the GCK:
 - + **Full GCK-VN** – current Full GCK-VN. (GCK version number).
 - + **GCK List** – list all GCKs stored in the radio, that is GCKN and GCK-VN attributes.
- **DMO info** – Direct Mode Operation information (RSSI and Frequency)

3.15

Radio Info

Depending on the codeplug configuration the manufacturer, type, and serial number information is available. The information is available through the service page accessible from the MMI.

The Radio Info provides the following data:

- Manufacturer
- Model Number
 -  **NOTICE:** The manufacturer and model number information is displayed only on radios distributed under Motorola Solutions trademark.
- Release Name – the version of radio software.
- Individual Short Subscriber Identity (ISSI) – the ISSI which is in use. If a SIM Card is present, the ISSI is read from the card, otherwise it is taken from the codeplug.
- TETRA Equipment Identity (TEI) – the TEI is displayed as a hexadecimal number.
- Serial number – Motorola Solutions serial number is displayed only on radios distributed under Motorola Solutions trademark.
- OPTA – if the BSI SIM support is disabled, no OPTA information is displayed.

3.16

Hardware Test

This mode allows performing basic hardware tests and share the results immediately on the display.



NOTICE: The hardware test mode is only for use by authorized persons.

Use the following key combinations to access the hardware test: **1, 2, 3** (hold all simultaneously) and then press **On/Off** key.

This page intentionally left blank.

Appendix A

Service Information – EIA

Service orders are dealt with by two centres: European Radio Support Centre (ERSC) and European Systems and Components Centre (ESCC). This section contains contact details to service centers in Europe, Middle East, and Africa.

European Radio Support Centre (ERSC)

ERSC provides a remote Technical Support Service to help customers resolve technical issues and quickly restore their systems. The centre handles service orders for subscribers and accessories. This team of highly skilled professionals is available to the customers that have current ERSC service agreements in place. For further information and to verify whether your current service agreement entitles you to benefit from this service, contact your local customer support.

To contact ERSC, use the following EIA Integrated Call Center details:

E-mail: ersc@motorolasolutions.com.

Telephone: +49 (0)30 6686 1555

European Systems and Components Centre (ESCC)

ESCC provides a repair service for infrastructure equipment. Customers requiring a repair service should contact the Customer Information Desk and obtain a Return Material Authorization number. Unless advised otherwise, the equipment should then be shipped to the following address:

Motorola GmbH, European Systems Component Center, Am Borsigturm 130, 13507 Berlin, Germany

E-mail: escadmin@motorolasolutions.com.

Telephone: +49 (0)30 6686 1404

Mon – Fri, 08:00 am – 06:00 pm (CET)

Table 20: Service Information — Telephone Numbers to EIA Integrated Call Center

Country	Telephone Number
Austria	1206091087
Denmark	43682114
France	157323434
Germany	6950070204
Italy	291483230
Lithuania	880030828
Netherlands	202061404
Norway	24159815
Portugal	800552277
Russia	810800228 41044 (Alternative 8108001201011)
South Africa	800981900
Spain	912754787

Country	Telephone Number
United Kingdom	2030277499
Other Countries	+42 0533336946

Parts Identification and Ordering

To get help in identification of non-referenced spare parts, contact your local Motorola Solutions Customer Care Organization.

To request replacement parts, kits and assemblies, place orders directly through your Motorola Solutions local distribution organization or through <http://emeaonline.motorolasolutions.com>.

EIA Test Equipment Support

For information related to support and service of Motorola Solutions Test Equipment, contact your local Motorola Solutions Customer Care Organization or see <http://emeaonline.motorolasolutions.com>.

For customers in Germany, contact the Equipment Service Group in Germany:

Telephone: +49 (0) 6128 702179

Fax: +49 (0) 6128 951046

Latest Versions of Manuals

To download the latest versions of technical manuals, see <http://emeaonline.motorolasolutions.com>.

Submit Your Comments

If you have any comments or would like to report a problem regarding Motorola Solutions publications, send an e-mail to: esc.admin@motorolasolutions.com.

Appendix B

Service Information – AME

This topic contains contact details to service centers in Asia and Pacific region.

Technical Support

Technical support is available to assist the dealer/distributor in resolving any malfunction which may be encountered. Initial contact should be by telephone wherever possible. When contacting Motorola Solutions Technical Support, be prepared to provide the product model number and the serial number.

Further Assistance from Motorola Solutions

You can also contact the Customer Help Desk through the website: http://www.motorolasolutions.com/en_xp/products. If a unit requires further complete testing, knowledge and/or details of component level troubleshooting or service than is customarily performed at the basic level, send the radio to a Motorola Solutions Service Center as listed in the following table:

Table 21: Service Information – Telephone Numbers and Addresses of the Asia and Pacific Motorola Solutions Centers

Country	Telephone Number	Address
Singapore	+65-6352-6383	Motorola Solutions Singapore Pte. Ltd, c/o Azure Engineering, 49 Jalan Pemimpin, #03-11 APS Industrial Building, Singapore 577203 Contact: Mareen Phua E-mail: mareen@azure.com.sg Enquiry: Tay Yong Hock E-mail: yonghock.tay@motorolasolutions.com
Malaysia	+603-7809-0000	Motorola Solutions Sdn. Bhd. Level 14, Persoft Tower, No. 68, Pesiaran Tropicana, 47410 Petaling Jaya, Selangor Darul Ehsan, Malaysia Contact: Koh Tiong Eng E-mail: A21001@motorolasolutions.com
Indonesia	+62-21-3043-5239	PT. Motorola Solutions Indonesia 30th Floor, Gedung BRI II, Suite 3001, Jl. Jend. Sudirman Kav. 44-46, Jakarta 10210, Indonesia Contact: Eko Haryanto E-mail: Eko.Haryanto@motorolasolutions.com
Thailand	Tel: +662-653-220	Motorola Solutions (Thailand) Ltd.

Country	Telephone Number	Address
	Fax: +668-254-5922	142 Two Pacific Place Suite 2201, 3220 Sukhumvit Road, Klongtoey, Bangkok 10110 Contact: Nitas Vatanasupapon E-mail: Nitas@motorolasolutions.com
India	+91-9844218850	Motorola Solutions India Pvt. Ltd. C/o Communication Test Design India Private Limited, #4, 5 Maruthi Industrial Estate, Rajapalya, Hoodi Village, Bangalore - 560048, India Contact: K. Umamaheswari E-mail: umamaheshwari@motorolasolutions.com
China	+86-10-8473-5128	Motorola Solutions (China) Co. Ltd. No. 1 Wang Jing East Road, Chao Yang District, Beijing, 100102, P.R. China Contact: Sophy Wang E-mail: C18170@motorolasolutions.com
Hong Kong	852-2966-4823	Motorola Solutions Asia Pacific Ltd. Unit 1807-1812, 18/F, Two Harbourfront, 22 Tak Fung Street, Hung Hom, Kowloon, Hong Kong Contact: Judy Leung E-mail: Judy.Leung@motorolasolutions.com
Philippines	Tel: +632 858-7500 Fax: +632 841-0681	Motorola Communications Philippines, Inc. Unit 2102, One Global Place Building, 5th Ave., Bonifacio Global City, Taguig, Philippines 1634. Contact: Arthur Nieves E-mail: Arthur.Nieves@motorolasolutions.com
Korea	+822-3497-3649	Motorola Solutions Korea, Inc. 9th Floor, Hibrand Building, 215, Yangjae-Dong, Seocho-Gu, Seoul, 137-924, Korea. Contact: KS Kwak E-mail: r45321@motorolasolutions.com
Taiwan	+886-2-8729 8000	Motorola Solutions Taiwan, Ltd. 8F, No. 9, Songgao Rd., Taipei 110,

Country	Telephone Number	Address
		Taiwan (R.O.C.) Contact: Michael Chou E-mail: ftpe239@motorolasolutions.com
Australia	+613-9847-7725	Motorola Solutions Australia Pty. Ltd. 10 Wesley Court, Tally Ho Business Park, East Burwood Victoria 3151, Australia. E-mail: servicecentre.au@motorolasolutions.com

Piece Parts

Some replacement parts, spare parts, and/or product information can be ordered directly. If a complete Motorola Solutions part number is assigned to the part, it is available from Motorola Solutions Service Organization. If no part number is assigned, the part is not normally available from Motorola Solutions. If a list of parts is not included, that means that no user-serviceable parts are available for that kit or assembly.

Customer Programming Software has no capability to tune the radio. Tuning the radio can only be performed at the factory or at the appropriate Motorola Solutions Repair Center. Component replacement can affect the radio tuning and must only be performed by the appropriate Motorola Solutions Repair Center.

All orders for parts/information should include the complete Motorola Solutions identification number. All part orders should be directed to your local Motorola Solutions Service Organization. See your latest price pages.

Parts Identification and Ordering

Request for help in identification of non-referenced spare parts should be directed to the Customer Care Organization of Motorola Solutions local area representation. Orders for replacement parts, kits, and assemblies should be placed directly on Motorola Solutions local distribution organization or via Motorola Solutions Online (Extranet).

This page intentionally left blank.

Appendix C

Service Information – Americas

This topic contains contact details to service centers in Latin America and Caribbean region.

Technical Support

To request technical support, go to <https://businessonline.motorolasolutions.com>, **Contact Us**.

Some replacement parts, spare parts, and/or product information can be ordered directly. If a complete Motorola Solutions part number is assigned to the part, it is available from Motorola Solutions. If no part number is assigned, the part is not normally available from Motorola Solutions. If the part number is appended with an asterisk, the part is serviceable by Motorola Solutions Depot only. If a list of parts is not included, that means that no user-serviceable parts are available for that kit or assembly.

Warranty and Repairs

Table 22: Service Information – Telephone Numbers and Addresses of Latin America Radio Support Centers

Country	Telephone Number	Address
Colombia	571- 376-6990	MOTOROLA DE COLOMBIA SERVICE CENTRE Torre Banco Ganadero Carrera 7 No. 71-52 Torre B piso 13 Oficina 1301 Bogota
Mexico	5252576700	MOTOROLA DE MEXICO SERVICE CENTRE Bosques de Alisos #125 Col. Bosques de las Lomas CP 05120 Mexico DF

Piece Parts

To order parts in Latin America and the Caribbean contact your local Motorola Solutions CGISS representative.

Table 23: Service Information – Telephone Numbers and Addresses of Latin America Motorola Solutions Centers

Country	Telephone Number	Address
Argentina	5411-4317-5300	MOTOROLA DE ARGENTINA Ave. del Libertador 1855 B1638BGE, Vicente Lopez Buenos Aires
Brasil	5511-3847-668	MOTOROLA DO BRASIL LTDA. Av. Chedid Jafet

Country	Telephone Number	Address
		222 Bloco D Conjuntos 11,12,21,22 E 41 Condominio Millennium Office Park 04551-065- Vila Olimpia, Sao Paulo
Chile	562-338-9000	MOTOROLA CHILE Ave. Nueva Tajamar 481 Edif. World Trade Center Of. 1702, Torre Norte Las Condes Santiago
Colombia	571-376-6990	MOTOROLA DE COLOMBIA, LTDA. Carrera 7 #71-52 Torre A, Oficina 1301 Bogotá
Costa Rica	506-201-1480	MOTOROLA DE COSTA RICA Parque Empresarial Plaza Roble Edificio El Portico, 1er Piso Centro de Negocios Internacional Guachepelin, Escazu San Jose
Ecuador	5932-264-1627	MOTOROLA DEL ECUADOR Autopist Gral. Rumiñahui, Puente 2 Conjunto Puerta del Sol Este-Ciudad Jardin Pasa E, Casa 65 Quito
Mexico	52-555-257-6700	MOTOROLA DE MEXICO, S.A. Calle Bosques de Alisos #125 Col. Bosques de Las Lomas 05120 México D.F.
Peru	511-211-0700	MOTOROLA DEL PERU, S.A. Ave. República de Panama 3535 Piso 11, San Isidro Lima 27
USA	954-723-8959	MOTOROLA SOLUTIONS, INC. Latin American Countries Region 789 International Parkway Sunrise, FL 33325
Venezuela	58212-901-4600	MOTOROLA DE LOS ANDES C.A. Ave. Francisco de Miranda Centro Lido, Torre A Piso 15, El Rosal Caracas, 1060