

ASTRO P25

APX™ Two-Way Radios

APX N30 Quick Start Guide

Model 2

en-US	cs-CZ	da-DK	de-DE	es-ES	el-GR	fr-FR
it-IT	lv-LV	hu-HU	nl-NL	pl-PL	pt-PT	ro-RO
sk-SK	fi-FI	sv-SE	tr-TR	he-IL		



MARCH 2024

© 2024 Motorola Solutions, Inc. All Rights Reserved.



PMLN8584B

Important Safety Information

RF Energy Exposure and Product Safety Guide for Portable Two-Way Radios

ATTENTION!

⚠ CAUTION:

This radio is restricted to Occupational use only. Before using the radio, read the RF Energy Exposure and Product Safety Guide for Portable Two-Way Radios which contains important operating instructions for safe usage and RF energy awareness and control for Compliance with applicable standards and Regulations.

Radio Overview

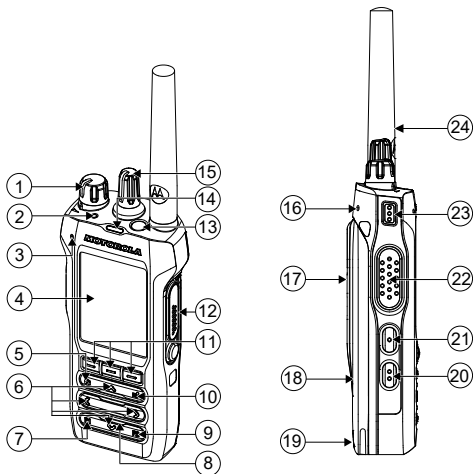

- | | |
|-------------------------------|------------------------------|
| 1. On/Off/Volume Control knob | 14 Top Light Bar |
| 2. Status LED | 15 Channel Selector knob |
| 3. Digital Mic 2 | 16 Digital Mic 1 |
| 4. Display | 17 Belt Clip Bracket |
| 5. Home button | 18 Battery |
| 6. 4-Way Navigation buttons | 19 Charging Contacts |
| 7. Programmable button 1 (P1) | 20 2-Dot Programmable button |
| 8. Speaker | 21 1-Dot Programmable button |
| 9. Programmable button 2 (P2) | 22 Push-to-Talk (PTT) button |
| 10. Notification button | 23 3-Dot Programmable button |
| 11. Menu Select buttons | 24 Antenna |
| 12. Accessory Connector | |
| 13. Top (Orange) button | |

Turning the Radio On or Off

Ensure that the battery is fully charged before the first use.

Turning the Radio On

Turn the **On/Off/Volume Control** knob clockwise until it clicks.

Turning the Radio Off

Turn the **On/Off/Volume Control** knob counterclockwise until it clicks.

Selecting Zones and Channels

Rotate the **Channel Selector** knob to the desired Channel.

Accessing Radio Call Activities

Perform one of the following actions:

- To call, press and hold the **PTT** button.
- To listen, release the **PTT** button.
- To adjust volume, turn the **On/Off/Volume Control** knob.
- To monitor, press the programmed **Monitor** button and listen.

Sending an Emergency Alarm

1. Press and hold the **Top (Orange)** button.
Your radio shows the following indications:
 - A tone sounds.
 - The red LED illuminates.
 - The display shows **Top (Orange)** and the current zone/channel.
 - When acknowledgment is received, you hear four beep tones; alarm ends; and radio exits emergency
2. Press and hold the **Top (Orange)** button to exit emergency.

Sending an Emergency Call

1. Press the **Top (Orange)** button.
2. Press and hold the **PTT** button to speak.
3. Release the **PTT** button to end call.
4. Press and hold **Top (Orange)** button to exit emergency.

Sending a Silent Emergency Call

1. Press the **Top (Orange)** button.
2. Silent emergency continues until you perform one of the following:
 - Press and hold the **Top (Orange)** button to exit emergency state.
 - Press and release the **PTT** button to exit the Silent Emergency Alarm mode and enter regular dispatch or Emergency Call mode.

Status Icons



Battery Level



Received Signal Strength Indicator (RSSI)



RSSI Receiving



RSSI Transmitting



Direct Mode



Monitor



Power Level High



Power Level Low



Scan



Secure Operation



Advanced Encryption Standard (AES) Secure Operation



Global Positioning System (GPS)



User Login Indicator (IP Packet Data)



Data Activity



Bluetooth®



Wi-Fi Strength



Blinking/Steady Dot



Vote Scan



Bluetooth Connected

Notes

Důležité bezpečnostní informace

Vystavení vysokofrekvenční energii a bezpečnostní příručka produktu pro přenosné duplexní radiostanice

UPOZORNĚNÍ!

⚠ UPOZORNĚNÍ:

Tato vysílačka je určena pouze k pracovnímu použití. Před použitím vysílačky si přečtěte příručku k vystavení vysokofrekvenční energii a bezpečnostní příručku produktu pro přenosné duplexní radiostanice obsahující důležité pokyny pro bezpečné používání výrobku a informace o vysokofrekvenční energii v souladu s příslušnými normami a předpisy.

Přehled vysílačky

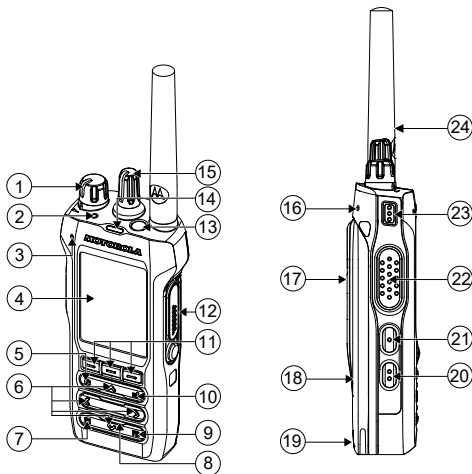

- | | |
|---|--|
| 1. Ovládací knoflík Zap/Vyp/
Hlasitost | 14 Horní světelná lišta |
| 2. Stavová kontrolka LED | 15 Knoflík pro výběr kanálu |
| 3. 2. digitální mikrofon | 16 1. digitální mikrofon |
| 4. Displej | 17 Držák spony na opasek |
| 5. Tlačítko Domů | 18 Baterie |
| 6. Čtyřsměrná navigační
tlačítka | 19 Kontakty pro nabíjení |
| 7. Programovatelné tlačítko 1
(P1) | 20 Programovatelné tlačítko se
2 tečkami |
| 8. Reproduktor | 21 Programovatelné tlačítko
s 1 tečkou |
| 9. Programovatelné tlačítko 2
(P2) | 22 Tlačítko Push-to-Talk (PTT) |
| 10. Tlačítko oznámení | 23 Programovatelné tlačítko se
3 tečkami |
| 11. Tlačítka výběru nabídky | 24 Anténa |
| 12. Konektor pro příslušenství | |
| 13. Horní (oranžové) tlačítko | |

Vypnutí a zapnutí vysílačky

Před prvním použitím se ujistěte, že je baterie plně nabitá.

Zapnutí vysílačky

Otočte ovládacím **knoflíkem Zap/Vyp/Hlasitost** ve směru hodinových ručiček, dokud necvakne.

Vypnutí vysílačky

Otočte ovládacím **knoflíkem Zap/Vyp/Hlasitost** proti směru hodinových ručiček, dokud necvakne.

Výběr pásem a kanálů

Otočte **knoflík pro výběr kanálu** na požadovaný kanál.

Přístup k aktivitám hovorů na vysílače

Proveďte některou z následujících operací:

- Jestliže chcete volat, podržte stisknuté tlačítko **PTT**.

- Chcete-li poslouchat, uvolněte tlačítko **PTT**.
- Chcete-li upravit hlasitost, otočte **ovládacím knoflíkem Zap/Vyp/Hlasitost**.
- Chcete-li monitorovat, stiskněte naprogramované tlačítko **Monitorování** a poslouchejte.

Odeslání tísňového alarmu

- Podržte stisknuté **horní (oranžové)** tlačítko.

Na vysílače se zobrazí následující:

- Zazní tón.
- Rozsvítí se červená kontrolka LED.
- Na displeji se zobrazí nápis **Horní (oranžové)** a aktuální pásmo/kanál.
- Když obdržíte potvrzení o příjmu, uslyšíte čtyři pípnutí, alarm se ukončí a vysílačka opustí režim tísňové situace.

- Režim tísňové situace ukončíte podržením tlačítka **horního (oranžového)** tlačítka.

Odeslání tísňového volání

- Stiskněte **horní (oranžové)** tlačítko.
- Podržte stisknuté tlačítko **PTT** a začněte mluvit.
- Uvolněním tlačítka **PTT** hovor ukončete.
- Režim tísňové situace ukončíte podržením tlačítka **horního (oranžového)** tlačítka.

Odeslání tichého tísňového volání

- Stiskněte **horní (oranžové)** tlačítko.
- Tichý tísňový hovor probíhá až do provedení některé z následujících akcí:
 - Režim tísňové situace ukončíte podržením tlačítka **horního (oranžového)** tlačítka.
 - Stisknutím a uvolněním tlačítka **PTT** ukončíte režim tichého tísňového alarmu a přejdete do běžného provozního režimu nebo do režimu tísňového volání.

Stavové ikony



Stav baterie



Indikátor síly přijímaného signálu (RSSI)



Přijem RSSI



Vysílání RSSI



Přímý režim



Monitorování



Vysoká úroveň výkonu



Nízká úroveň výkonu



Skenování



Zabezpečený provoz.



Zabezpečený provoz přes AES (Advanced Encryption Standard)



Globální polohový systém (GPS)



Indikátor přihlášení uživatele (data IP paketů)



Datová aktivita



Bluetooth®



Síla Wi-Fi



Blikající/svítící tečka



Vyhledávání hlasování



Bluetooth připojeno

Poznámky

Vigtige sikkerhedsoplysninger

RF-energieksponerings- og produktsikkerhedsvejledning til bærbare tovejsradioer

OBS!

⚠ FORSIGTIG:

Denne radio er kun beregnet til erhvervsbrug. Inden brug af radioen skal du læse RF-energieksponerings- og produktsikkerhedsvejledningen til bærbare tovejsradioer, som indeholder vigtige betjeningsinstruktioner om sikker brug og RF-energitilstedeværelse og kontrol af overholdelse med gældende standarder og bekendtgørelser.

Oversigt over radio

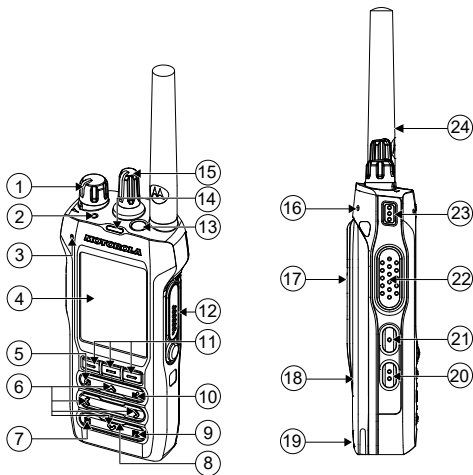

- | | |
|--|--------------------------------|
| 1. Betjeningsknappen Til/fra/lydstyrke | 14 Øverste lysbjælke |
| 2. Status LED | 15 Kanalvælgerknap |
| 3. Digital mikrofon 2 | 16 Digital Mikrofon 1 |
| 4. Display | 17 Bælteclipbeslag |
| 5. Startknap | 18 Batteri |
| 6. 4-vejs navigationsknapper | 19 Opladningskontakter |
| 7. Programmerbar knap 1 (P1) | 20 2-punkts programmerbar knap |
| 8. Højttaler | 21 1-punkts programmerbar knap |
| 9. Programmerbar knap 2 (P2) | 22 PTT-knap (Tryk for at tale) |
| 10. Meddelelsesknap | 23 3-punkts programmerbar knap |
| 11. Menuvalgsknapper | 24 Antenne |
| 12. Stik til tilbehør | |
| 13. Øverste (orange) knap | |

Sådan tænder eller slukker du radioen

Sørg for, at batteriet er fuldt opladet, før det tages i brug første gang.

Sådan tænder du radioen

Drej **Tænd/Sluk/Volumen**-knappen med uret, indtil den klikker.

Sådan slukker du radioen

Drej **Tænd/Sluk/Volumen**-knappen mod uret, indtil den klikker.

Valg af zoner og kanaler

Drej knappen **Kanalvælger** til den ønskede kanal.

Adgang til radioopkaldsaktiviteter

Udfør en af følgende handlinger:

- Tryk på og hold knappen **PTT** nede for at foretage et opkald.
- Slip knappen **PTT** for at lytte.
- Drej på knappen **Til/fra/lydstyrke** for at justere lydstyrken.
- For at overvåge skal du trykke på den programmerede **Overvåg**-knap og lytte.

Afsendelse af en nødalarm

1. Tryk og hold nede på **Øverste (orange)**-knappen. Din radio viser følgende indikationer:
 - Der lyder en tone.
 - Den røde lysdiode tændes.
 - Displayet viser **Øverste (orange)** og den aktuelle zone/kanal.
 - Når bekræftelsen er modtaget, hører du fire bip-toner: Alarmen ophører, og radioen afslutter nødopkaldet
2. Tryk og hold nede på den **Øverste (orange)** knap for at afslutte nødsituation.

Afsendelse af et nødopkald

1. Tryk på den **Øverste (orange)** knap.
2. Tryk på knappen **PTT**, og hold den nede for at tale.
3. Slip knappen **PTT** for at afslutte opkaldet.
4. Tryk på knappen **Øverste (orange)**, og hold den nede for at afslutte nødsituation.



Afsendelse af et lydløst nødopkald

1. Tryk på den **Øverste (orange)** knap.
2. Lydløs nødsituation fortsætter, indtil du udfører et af følgende:
 - Trykker på den **Øverste (orange)** knap og hold den nede for at afslutte nødsituationstilstand.
 - Trykker på knappen **PTT** og slipper den igen for at afslutte den lydløse nødalarmtilstand og starte almindelig udsendelses- eller nødopkaldstilstand.

Statusikoner



Batteriniveau

	Indikator for modtaget signalstyrke (RSSI)
	RSSI modtager
	RSSI sender
	Direkte tilstand
	Monitorering
	Effektniveau højt
	Effektniveau lavt
	Scan
	Sikker operation
	Sikker drift med AES (Advanced Encryption Standard)

	Global Positioning System (GPS)
	Indikator for brugerlogin (IP-pakke data)
	Dataaktivitet
	Bluetooth®
	Wi-Fi-styrke
	Blinkende/konstant prik
	Frekvensscanning
	Bluetooth tilsluttet

Bemærkninger

Wichtige Sicherheitsinformationen

Handbuch zur HF-Energiestrahlung und Produktsicherheit für Handfunkgeräte

ACHTUNG!

⚠ VORSICHT:

Dieses Funkgerät ist nur für die berufliche Nutzung vorgesehen. Lesen Sie vor Verwendung des Funkgeräts das Handbuch zur HF-Energiestrahlung und Produktsicherheit für Handfunkgeräte. Es enthält wichtige Betriebsanweisungen für den sicheren Umgang sowie Sicherheitsinformationen zum Thema Hochfrequenzstrahlung zur Einhaltung der geltenden Normen und Richtlinien.

Überblick über das Funkgerät

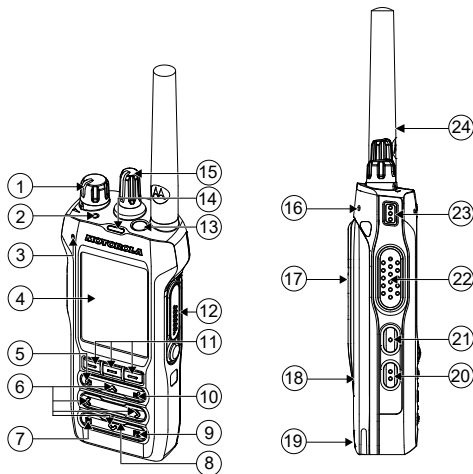

- | | |
|---------------------------------|----------------------------------|
| 1. Ein-/Aus-/Lautstärkereger | 14 Obere Leuchtdiode |
| 2. Status-LED | 15 Kanalwahlschalter |
| 3. Digitales Mikrofon 2 | 16 Digitales Mikrofon 1 |
| 4. Display | 17 Gürtelcliphalterung |
| 5. Starttaste | 18 Akku |
| 6. 4-Wege-Navigationstasten | 19 Ladekontakte |
| 7. Programmierbare Taste 1 (P1) | 20 Programmierbare 2-Punkt-Taste |
| 8. Lautsprecher | 21 Programmierbare 1-Punkt-Taste |
| 9. Programmierbare Taste 2 (P2) | 22 Sendetaste (PTT) |
| 10. Benachrichtigungstaste | 23 Programmierbare 3-Punkt-Taste |
| 11. Menüauswahlstasten | 24 Antenne |
| 12. Zubehörschluss | |
| 13. Taste oben (orange) | |

Ein- und Ausschalten des Funkgeräts

Stellen Sie vor der ersten Verwendung sicher, dass der Akku vollständig aufgeladen ist.

Einschalten des Funkgeräts

Drehen Sie den **Ein-/Aus-/Lautstärkereger** im Uhrzeigersinn, bis Sie ein Klicken hören.

Ausschalten des Funkgeräts

Drehen Sie den **Ein-/Aus-/Lautstärkereger** gegen den Uhrzeigersinn, bis Sie ein Klicken hören.

Auswählen von Zonen und Kanälen

Drehen Sie den **Kanalwahlschalter** auf den gewünschten Kanal.

Zugriff auf Rufaktivitäten des Funkgeräts

Führen Sie eine der folgenden Aktionen aus:

- Zum Anrufen halten Sie die **PTT**-Taste gedrückt.
- Zum Zuhören lassen Sie die **PTT**-Taste los.

- Um die Lautstärke anzupassen, drehen Sie den **Ein-/Aus-/Lautstärkereger**.
- Zum Überwachen drücken Sie die programmierte **Überwachungstaste** und hören Sie zu.

Senden eines Notalarms

1. Halten Sie die **Taste oben (orange)** gedrückt. Ihr Funkgerät verhält sich wie folgt:
 - Ein Hinweiston ertönt.
 - Die rote LED leuchtet auf.
 - Auf der Anzeige wird **Taste oben (orange)** und die aktuelle Zone/der aktuelle Kanal angezeigt.
 - Bei Empfang der Bestätigung hören Sie vier Signaltöne. Der Alarm endet, und das Gerät beendet den Notruf.
2. Halten Sie die **Taste oben (orange)** gedrückt, um den Notrufmodus zu beenden.



















Senden eines Notrufs

1. Drücken Sie die **Taste oben (orange)**.
2. Halten Sie die **PTT**-Taste zum Sprechen gedrückt.
3. Lassen Sie die **PTT**-Taste los, um den Ruf zu beenden.
4. Halten Sie die **Taste oben (orange)** gedrückt, um den Notrufmodus zu beenden.

Senden eines stillen Notrufs

1. Drücken Sie die **Taste oben (orange)**.
2. Der stille Notruf wird so lange fortgesetzt, bis Sie eine der folgenden Schritte ausführen:
 - Halten Sie die **Taste oben (orange)** gedrückt, um den Notrufmodus zu beenden.
 - Drücken Sie kurz auf die **PTT**-Taste, um den stillen Notrufmodus zu beenden und in den regulären Funkzentralen- oder Notrufmodus zu wechseln.

Statussymbole

	Akkustand		Sicherer AES-Vorgang (Advanced Encryption Standard)
	Anzeige der Empfangssignalstärke (RSSI, Received Signal Strength Indicator)		GPS (Global Positioning System)
	RSSI-Empfang		Benutzeranmeldungsanzeige (IP-Paketdaten)
	RSSI-Übertragung		Datenaktivität
	Direktmodus		Bluetooth®
	Überwachung		WLAN-Signalstärke
	Leistungspegel: Hoch		Blinkender/ Durchgehend leuchtender Punkt
	Leistungspegel: Niedrig		Auswahlverfahren nach Signalgüte (Vote-Scan)
	Scan		Bluetooth verbunden
	Sicherer Betrieb		

Notizen

Información sobre seguridad importante

Guía de exposición a radiofrecuencia y seguridad del producto para radios bidireccionales portátiles

¡ATENCIÓN!

⚠ PRECAUCIÓN:

El uso de esta radio está restringido en exclusiva al ámbito laboral. Antes de utilizar la radio, lea la Guía de exposición a radiofrecuencia y seguridad del producto para radios bidireccionales portátiles, que contiene importantes instrucciones de funcionamiento para un uso seguro, así como información importante sobre la energía de radiofrecuencia y su control, en cumplimiento de las normas y normativas aplicables.

Descripción general de la radio

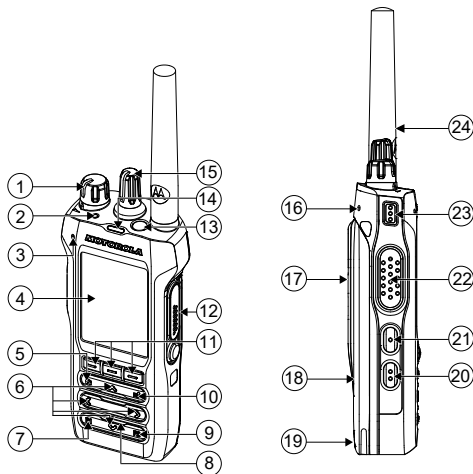

- | | |
|--|-----------------------------------|
| 1. Mando de control de encendido/apagado/volumen | 14 Barra luminosa superior |
| 2. LED de estado | 15 Selector de canales |
| 3. Micrófono digital 2 | 16 Micrófono digital 1 |
| 4. Pantalla | 17 Clip para cinturón |
| 5. Botón de inicio | 18 Batería |
| 6. Botones de navegación de 4 direcciones | 19 Contactos de carga |
| 7. Botón programable 1 (P1) | 20 Botón de 2 puntos programable |
| 8. Altavoz | 21 Botón de 1 punto programable |
| 9. Botón programable 2 (P2) | 22 Botón PTT (pulsar para hablar) |
| 10. Botón de notificación | 23 Botón de 3 puntos programable |
| 11. Botones de selección de menú | 24 Antena |
| 12. Conector de accesorios | |
| 13. Botón superior (naranja) | |

Encendido o apagado de la radio

Asegúrese de que la batería está totalmente cargada antes del primer uso.

Encendido de la radio

Gire el mando de **control de encendido/apagado/volumen** hacia la derecha hasta que se oiga un clic.

Apagado de la radio

Gire el mando de **control de encendido/apagado/volumen** hacia la izquierda hasta que se oiga un clic.

Selección de zonas y canales

Gire el **selector de canales** hasta el canal deseado.

Acceso a las actividades de llamada de radio

Realice una de las siguientes acciones:

- Para llamar, mantenga pulsado el botón **PTT**.

- Para escuchar, suelte el botón **PTT**.
- Para ajustar el volumen, gire el mando de **control de encendido/apagado/volumen**.
- Para monitorizar, pulse el botón de **monitorización** programado y escuche.

Envío de una alarma de emergencia

1. Mantenga pulsado el botón **superior (naranja)**.

En la radio se muestran las siguientes indicaciones:

- Suena un tono.
- El indicador LED rojo se ilumina.
- En la pantalla se muestra **Superior (naranja)** y la zona/canal actual.
- Cuando se reciba una confirmación, se oirán cuatro pitidos, la alarma terminará y la radio saldrá del modo de emergencia.

2. Mantenga pulsado el botón **superior (naranja)** para salir del estado de emergencia.

Envío de una llamada de emergencia

1. Pulse el botón **superior (naranja)**.
2. Mantenga pulsado el botón **PTT** para hablar.
3. Suelte el botón **PTT** para finalizar la llamada.
4. Mantenga pulsado el botón **superior (naranja)** para salir del modo de emergencia.

Envío de una llamada de emergencia silenciosa

1. Pulse el botón **superior (naranja)**.
2. La emergencia silenciosa continúa hasta que realice una de las siguientes acciones:
 - Mantenga pulsado el botón **superior (naranja)** para salir del estado de emergencia.
 - Pulse y suelte el botón **PTT** para salir del modo de alarma de emergencia silenciosa y entrar al centro de control de forma normal o al modo de llamada de emergencia.

Iconos de estado



Nivel de batería



Indicador de intensidad de la señal recibida (RSSI)



Recepción de RSSI



Transmisión de RSSI



Modo directo



Monitorización



Nivel de potencia alto



Nivel de potencia bajo



Exploración



Funcionamiento seguro



Funcionamiento seguro del estándar de cifrado avanzado (AES)



Sistema de posicionamiento global (GPS)



Indicador de inicio de sesión de usuario (datos de paquete IP)



Actividad de datos



Bluetooth®



Intensidad de la señal Wi-Fi



Punto intermitente/fijo



Rastreo de aceptación



Bluetooth conectado

Notas

Σημαντικές πληροφορίες ασφαλείας

Οδηγός σχετικά με την έκθεση σε ραδιοσυχνότητες και την ασφάλεια προϊόντος για φορητούς αμφίδρομους πομπодέκτες

ΠΡΟΣΟΧΗ!

⚠ ΠΡΟΣΟΧΗ:

Αυτός ο ασύρματος πομπодέκτης προορίζεται αποκλειστικά για επαγγελματική χρήση. Πριν χρησιμοποιήσετε τον ασύρματο πομπодέκτη, διαβάστε τον Οδηγό σχετικά με την έκθεση σε ραδιοσυχνότητες και την ασφάλεια προϊόντος για τους φορητούς ασύρματος πομπодέκτες αμφίδρομης επικοινωνίας, ο οποίος περιέχει σημαντικές οδηγίες για την ασφαλή χρήση του προϊόντος και τη συμμόρφωση με τα ισχύοντα πρότυπα και τους κανονισμούς που σχετίζονται με τις ραδιοσυχνότητες.

Επισκόπηση ασύρματος πομπодέκτη

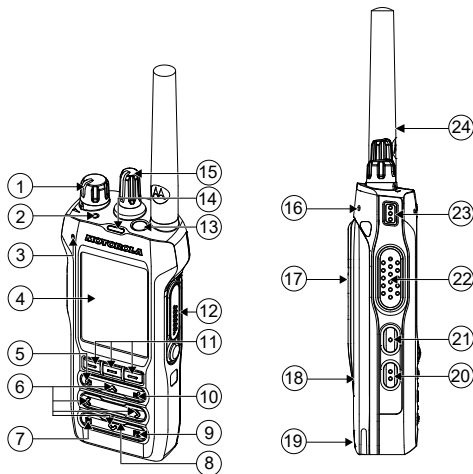

- | | |
|---|--|
| 1. Κουμπί ενεργοποίησης/
απενεργοποίησης/ελέγχου
έντασης ήχου | 14 Επάνω γραμμή φωτεινών
ενδείξεων |
| 2. Λυχνίες LED κατάστασης | 15 Κουμπί επιλογής καναλιού |
| 3. Ψηφιακό μικρόφωνο 2 | 16 Ψηφιακό μικρόφωνο 1 |
| 4. Οθόνη | 17 Αγκιστρο ζώνης |
| 5. Κουμπί αρχικής οθόνης | 18 Μπαταρία |
| 6. Κουμπιά πλοήγησης 4
κατευθύνσεων | 19 Επαφές φόρτισης |
| 7. Προγραμματιζόμενο κουμπί
1 (P1) | 20 Προγραμματιζόμενο κουμπί 2
κουκκίδων |
| 8. Ηχείο | 21 Προγραμματιζόμενο κουμπί 1
κουκκίδας |
| 9. Προγραμματιζόμενο κουμπί
2 (P2) | 22 Κουμπί Push-to-Talk (PTT)
συσκευής |
| 10. Κουμπί ειδοποίησης | 23 Προγραμματιζόμενο κουμπί 3
κουκκίδων |
| 11. Κουμπιά επιλογής μενού | 24 Κεραία |
| 12. Υποδοχή σύνδεσης
αξεσουάρ | |
| 13. Επάνω (πορτοκαλί) κουμπί | |

Ενεργοποίηση ή απενεργοποίηση του ασύρματου πομποδέκτη

Βεβαιωθείτε ότι η μπαταρία είναι πλήρως φορτισμένη πριν από την πρώτη χρήση.

Ενεργοποίηση του ασύρματου πομποδέκτη

Περιστρέψτε το κουμπί **Ενεργοποίησης/Απενεργοποίησης/Ελέγχου έντασης ήχου** δεξιόστροφα μέχρι να ακουστεί ένα κλικ.

Απενεργοποίηση του ασύρματου πομποδέκτη

Περιστρέψτε το κουμπί **Ενεργοποίησης/Απενεργοποίησης/Ελέγχου έντασης ήχου** αριστερόστροφα μέχρι να ακουστεί ένα κλικ.

Επιλογή ζωνών και καναλιών

Περιστρέψτε το κουμπί **Επιλογής καναλιού** στο κανάλι που θέλετε.

Πρόσβαση σε δραστηριότητες κλήσης ασυρμάτου

Εκτελέστε μία από τις εξής ενέργειες:

- Για κλήση, πατήστε παρατεταμένα το κουμπί **PTT**.
- Για να ακούσετε, αφήστε το κουμπί **PTT**.
- Για να προσαρμόσετε την ένταση ήχου, περιστρέψτε το κουμπί **Ενεργοποίησης/Απενεργοποίησης/Ελέγχου έντασης ήχου**.
- Για έλεγχο, πατήστε το προγραμματιζόμενο κουμπί **Έλεγχος** και ακούστε.

Αποστολή ειδοποίησης έκτακτης ανάγκης

1. Πατήστε παρατεταμένα το **Επάνω (πορτοκαλί)** κουμπί. Στον ασύρματο πομποδέκτη εμφανίζονται οι ακόλουθες ενδείξεις:
 - Ακούγεται ένας ήχος.
 - Ανάβει η κόκκινη λυχνία LED.
 - Στην οθόνη εμφανίζονται η ένδειξη του **Επάνω (πορτοκαλί)** κουμπιού, η ζώνη και το κανάλι.
 - Όταν γίνει λήψη της επιβεβαίωσης, θα ακούσετε τέσσερα ηχητικά σήματα. Η ειδοποίηση σταματά και ο πομποδέκτης βγαίνει από τη λειτουργία έκτακτης ανάγκης.
2. Πατήστε παρατεταμένα το **Επάνω (πορτοκαλί)** κουμπί για έξοδο από την κατάσταση έκτακτης ανάγκης.

Αποστολή κλήσης έκτακτης ανάγκης

1. Πατήστε το **Επάνω (πορτοκαλί)** κουμπί.
2. Πατήστε παρατεταμένα το κουμπί **PTT** για να μιλήσετε.
3. Αφήστε το κουμπί **PTT**, για να τερματίσετε την κλήση.
4. Πατήστε παρατεταμένα το **Επάνω (πορτοκαλί)** κουμπί για έξοδο από την κατάσταση έκτακτης ανάγκης.

Αποστολή αθόρυβης κλήσης έκτακτης ανάγκης

1. Πατήστε το **Επάνω (πορτοκαλί)** κουμπί.

2. Η σιωπηλή κατάσταση έκτακτης ανάγκης διατηρείται μέχρι να κάνετε μία από τις εξής ενέργειες:
- Να πατήσετε παρατεταμένα το **Επάνω (πορτοκαλί)** κουμπί για έξοδο από την κατάσταση έκτακτης ανάγκης.
 - Να πατήσετε και να αφήσετε το κουμπί **PTT**, για να κλείσετε τη λειτουργία αθόρυβης ειδοποίησης έκτακτης ανάγκης και να μπειτε στη λειτουργία κανονικής αποστολής ή κλήσης έκτακτης ανάγκης.

Εικονίδια κατάστασης

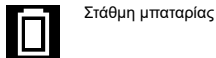

Στάθμη μπαταρίας



Ένδειξη ισχύος σήματος λήψης (RSSI)



Λήψη RSSI



Μετάδοση RSSI



Άμεση λειτουργία



Έλεγχος



Υψηλή στάθμη ισχύος



Χαμηλή στάθμη ισχύος



Σάρωση



Ασφαλής λειτουργία



Ασφαλής λειτουργία Advanced Encryption Standard (AES)



Παγκόσμιο σύστημα εντοπισμού θέσης (GPS)



Ένδειξη σύνδεσης χρήστη (Πακέτα δεδομένων IP)



Δραστηριότητα δεδομένων



Bluetooth®



Ισχύς Wi-Fi



Παλλόμενη/σταθερή κουκκίδα



Επιλεκτική σάρωση



Έχει γίνει σύνδεση μέσω Bluetooth

Informations de sécurité importantes

Guide relatif à la sécurité du produit et à l'exposition aux fréquences radio pour les radios professionnelles portatives

ATTENTION !

⚠ ATTENTION :

Cette radio est réservée à un usage professionnel exclusivement. Avant d'utiliser la radio, lisez le Guide relatif à la sécurité du produit et à l'exposition aux fréquences radio pour les radios professionnelles portatives. Il contient d'importantes instructions de fonctionnement relatives à la sécurité et à l'exposition aux fréquences radio, ainsi que des informations sur le contrôle de conformité aux normes et réglementations applicables.

Présentation de la radio

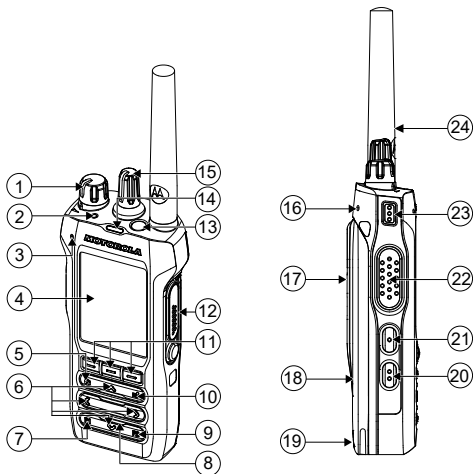

- | | |
|---|-----------------------------------|
| 1. Bouton Marche/Arrêt - Volume | 14 Barre lumineuse supérieure |
| 2. LED d'état | 15 Bouton de sélection de canal |
| 3. Micro numérique 2 | 16 Micro numérique 1 |
| 4. Écran | 17 Clip de ceinture |
| 5. Bouton d'accueil | 18 Batterie |
| 6. Boutons de navigation quadridirectionnelle | 19 Contacts de charge |
| 7. Bouton programmable 1 (P1) | 20 Bouton programmable à 2 points |
| 8. Haut-parleur | 21 Bouton programmable à 1 point |
| 9. Bouton programmable 2 (P2) | 22 Bouton PTT (Push-to-Talk) |
| 10. Bouton de notification | 23 Bouton programmable à 3 points |
| 11. Boutons de sélection de menus | 24 Antenne |
| 12. Connecteur d'accessoire | |
| 13. Bouton supérieur (orange) | |

Activation/désactivation de la radio

Assurez-vous que la batterie est complètement chargée avant la première utilisation.

Activation de la radio

Tournez le bouton **Marche/Arrêt - Volume** dans le sens des aiguilles d'une montre jusqu'à ce que vous entendiez un clic.

Désactivation de la radio

Tournez le bouton **Marche/Arrêt - Volume** dans le sens inverse des aiguilles d'une montre jusqu'à ce que vous entendiez un clic.

Sélection de zones et de canaux

Faites tourner le bouton de **sélection de canal** jusqu'au canal de votre choix.

Accès aux activités d'appel radio

Effectuez l'une des opérations suivantes :

- Pour appeler, appuyez de manière prolongée sur le bouton **PTT**.
- Pour écouter, relâchez le bouton **PTT**.
- Pour régler le volume, tournez le bouton **Marche/Arrêt - Volume**.
- Pour surveiller, appuyez sur le bouton programmé **Écoute** et écoutez.

Envoi d'une alarme d'urgence

1. Appuyez de manière prolongée sur le bouton **supérieur (orange)**. Votre radio présente le comportement suivant :
 - Une tonalité est émise.
 - La LED rouge s'allume.
 - L'écran indique **Supérieur (orange)**, ainsi que la zone et le canal actuels.
 - Lors de la réception de l'accusé de réception, quatre signaux sonores retentissent, l'alarme s'arrête et la radio quitte l'état d'urgence.
2. Appuyez de manière prolongée sur le bouton **supérieur (orange)** pour quitter l'état d'urgence.

Envoi d'un appel d'urgence



















1. Appuyez sur le bouton **supérieur (orange)**.
2. Maintenez le bouton **PTT** enfoncé pour parler.
3. Pour mettre fin à l'appel, relâchez le bouton **PTT**.
4. Pour quitter le mode d'urgence, appuyez de manière prolongée sur le bouton **supérieur (orange)**.

Envoi d'un appel d'urgence silencieuse

1. Appuyez sur le bouton **supérieur (orange)**.
2. L'urgence silencieuse se poursuit jusqu'à ce que vous effectuiez l'une des opérations suivantes :

- Appuyer de manière prolongée sur le bouton **supérieur (orange)** pour quitter l'état d'urgence.
- Appuyer de manière prolongée sur le bouton **PTT** pour quitter le mode d'alarme d'urgence silencieuse et accéder au mode d'exploitation radio normal ou d'appel d'urgence.

Icônes d'état

	Niveau de la batterie		Balayage
	Indicateur de puissance du signal reçu (RSSI)		Fonctionnement sécurisé
	Réception RSSI		Fonctionnement sécurisé AES (Advanced Encryption Standard)
	Émission RSSI		Système de localisation mondial (GPS)
	Mode Direct		Indicateur de connexion utilisateur (données par paquet IP)
	Écoute		Activité de données
	Niveau de puissance élevé		Bluetooth®
	Niveau de puissance faible		Puissance Wi-Fi
			Point clignotant/fixe
			Balayage avec sélection automatique



Bluetooth connecté

Informazioni importanti sulla sicurezza

Guida sull'esposizione a sorgenti di energia RF e sulla sicurezza del prodotto per radio ricetrasmittenti portatili

ATTENZIONE!

⚠ AVVERTENZA:

L'uso di questa radio è limitato esclusivamente a scopi professionali. Prima di utilizzare la radio, leggere la Guida sull'esposizione a sorgenti di energia RF e sulla sicurezza del prodotto per radio ricetrasmittenti portatili che contiene importanti istruzioni di funzionamento per utilizzare con sicurezza il dispositivo, nonché informazioni sull'esposizione all'energia RF e sul controllo nel rispetto delle norme e dei regolamenti vigenti in materia.

Panoramica della radio

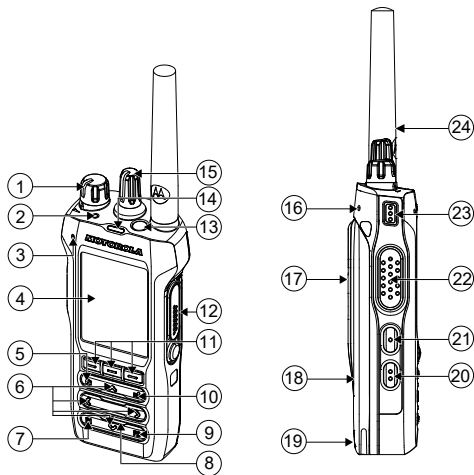

- | | |
|--|---|
| 1. Manopola On/Off/Controllo volume | 14 Barra luminosa superiore |
| 2. LED di stato | 15 Manopola selettore canali |
| 3. Microfono digitale 2 | 16 Microfono digitale 1 |
| 4. Display | 17 Staffa clip per cintura |
| 5. Pulsante Home | 18 Batteria |
| 6. Pulsanti di navigazione a 4 direzioni | 19 Contatti di ricarica |
| 7. Pulsante programmabile 1 (P1) | 20 Pulsante programmabile con 2 puntini |
| 8. Altoparlante | 21 Pulsante programmabile con 1 puntino |
| 9. Pulsante programmabile 2 (P2) | 22 Pulsante Push-To-Talk (PTT) |
| 10. Pulsante di notifica | 23 Pulsante programmabile con 3 puntini |
| 11. Pulsanti di selezione dei menu | 24 Antenna |
| 12. Connettore per accessori | |
| 13. Pulsante superiore (arancione) | |

Accensione o spegnimento della radio

Assicurarsi che la batteria sia completamente carica prima di utilizzare il prodotto per la prima volta.

Accensione della radio

Ruotare la manopola **On/Off/Controllo volume** in senso orario finché non si avverte un "clic".

Spegnimento della radio

Ruotare la manopola **On/Off/Controllo volume** in senso antiorario finché non si avverte un "clic".

Selezione di zone e canali

Ruotare la manopola del **selettore canali** sul canale desiderato.

Accesso alle attività delle chiamate radio

Effettuare una delle seguenti operazioni:

- Per chiamare, tenere premuto il pulsante **PTT**.
- Per ascoltare, rilasciare il pulsante **PTT**.
- Per regolare il volume, ruotare la manopola **On/Off/Controllo volume**.
- Per eseguire il monitoraggio, premere il pulsante programmato **Monitoraggio** e ascoltare.

Invio di un allarme di emergenza

1. Tenere premuto il pulsante **superiore (arancione)**.

La radio mostra le seguenti indicazioni:

- Viene emesso un tono.
 - Il LED si accende in rosso.
 - Sul display vengono visualizzati il pulsante **superiore (arancione)** e la zona/il canale corrente.
 - Una volta ricevuta la conferma, vengono emessi quattro segnali acustici. L'allarme si arresta e la radio esce dalla modalità di emergenza.
2. Tenere premuto il pulsante di **superiore (arancione)** per uscire dallo stato di emergenza.

Invio di una chiamata di emergenza









1. Premere il pulsante **superiore (arancione)**.
2. Tenere premuto il pulsante **PTT** per parlare.
3. Rilasciare il pulsante **PTT** per terminare la chiamata.
4. Per uscire dalla modalità di emergenza, tenere premuto il pulsante **superiore (arancione)**.

Invio di una chiamata di emergenza silenziosa

1. Premere il pulsante **superiore (arancione)**.
2. L'emergenza silenziosa continua fino a quando non si esegue una delle seguenti operazioni:

- Non viene premuto il pulsante **superiore (arancione)** per uscire dallo stato di emergenza.
- Non viene premuto e rilasciato il pulsante **PTT** per uscire dalla modalità di allarme di emergenza silenziosa e attivare la normale modalità di gestione delle chiamate o la chiamata di emergenza.

Icone di stato

	Livello batteria		Scansione
	RSSI (Received Signal Strength Indicator)		Funzionamento sicuro
	Ricezione RSSI		Funzionamento sicuro AES (Advanced Encryption Standard)
	Trasmissione RSSI		GPS (Global Positioning System)
	Modalità diretta		Indicatore di accesso utente (dati pacchetto IP)
	Monitoraggio		Attività dati
	Livello di potenza alto		Bluetooth®
	Livello di potenza basso		Potenza Wi-Fi
			Puntino lampeggiante/fisso
			Scansione selettiva



Bluetooth connesso

Svarīga drošības informācija

RF (radiofrekvences) enerģijas starojuma un ierīces drošības instrukcija pārnēsājamām divvirzienu radioiekārtām

UZMANĪBU!

⚠ UZMANĪBU:

Šo radio paredzēts izmantot tikai profesionālām vajadzībām.

Pirms radio lietošanas izlasiet RF (radiofrekvences) enerģijas starojuma un ierīces drošības instrukciju pārnēsājamām divvirzienu radioiekārtām, kas ietver būtiskus ekspluatācijas norādījumus drošai lietošanai, kā arī informāciju par RF enerģijas izpratni un vadību atbilstoši spēkā esošajiem standartiem un noteikumiem.

Radio pārskats

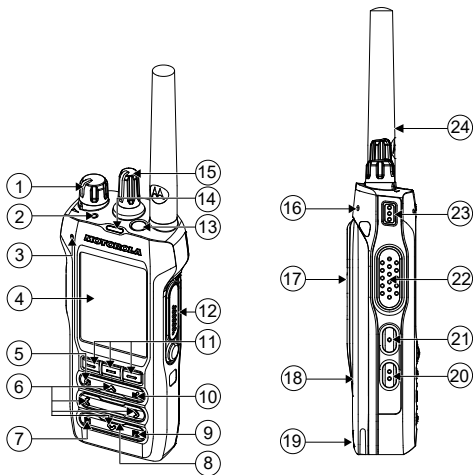

- | | |
|---|-----------------------------------|
| 1. Ieslēgšanas/Izslēgšanas/
Skaļuma vadības poga | 14 Augšējā gaismas josla |
| 2. Statusa LED | 15 Kanālu izvēles poga |
| 3. Digitālais mikrofons 2 | 16 Digitālais mikrofons 1 |
| 4. Displejs | 17 Jostas klipu stiprinājums |
| 5. Sākuma poga | 18 Akumulators |
| 6. 4 virzienu navigācijas pogas | 19 Uzlādes kontakti |
| 7. Programmējama poga 1
(P1) | 20 2 punktu programmējamā poga |
| 8. Skaļrunis | 21 1 punkta programmējamā poga |
| 9. Programmējama poga 2
(P2) | 22 Klausules pārraides (PPT) poga |
| 10. Paziņojumu poga | 23 3 punktu programmējamā poga |
| 11. Izvēlnes izvēles pogas | 24 Antena |
| 12. Piederumu savienotājs | |
| 13. Augšdaļas (oranžā) poga | |

Radio ieslēgšana vai izslēgšana

Pirms pirmās lietošanas pārliecinieties, ka akumulators ir pilnībā uzlādēts.

Radio ieslēgšana

Pulksteņrādītāja virzienā pagrieziet pogu **ieslēgt/Izslēgt/Skaļuma kontrole**, līdz tā noklikšķ.

Radio izslēgšana

Pretēji pulksteņrādītāja virzienam pagrieziet pogu **ieslēgt/Izslēgt/Skaļuma kontrole**, līdz tā noklikšķ.

Zonu un kanālu izvēle

Pagrieziet **kanālu izvēles** pogu uz vēlamo kanālu.

Piekluve radiozvana darbībām

Veiciet vienu no šīm darbībām:

- Lai pazvanītu, nospiediet un paturiet pogu **PTT**.

- Lai klausītos, atlaidiet pogu **PTT**.
- Lai pielāgotu skaļumu, pagrieziet **ieslēgšanas/izslēgšanas/skaļuma regulēšanas** pogu.
- Lai uzraudzītu, nospiediet uz ieprogrammētā **Monitora** pogas un klausieties.

Ārkārtas situācijas signāla sūtīšana

- Nospiediet un turiet pogu **Augša (oranžs)**.
Radio būs redzamas šādas indikācijas:
 - atskan skaņas signāls;
 - iedegas sarkana gaismas diode.
 - Displejā uzrādās **Augša (oranžs)** un pašreizējā zona/kanāls.
 - Tiklīdz tiks saņemts apstiprinājums, atskanēs četri īsi signāli, signāls izslēgsies un radioiekārta atceļ ārkārtas situācijas režīmu.
- Nospiediet un turiet pogu **Augša (oranžs)**, lai atceltu ārkārtas situācijas režīmu.



















Ārkārtas zvana sūtīšana

- Nospiediet pogu **Augša (oranžs)**.
- Lai runātu, nospiediet un turiet pogu **PTT**.
- Lai beigtu zvanu, atlaidiet pogu **PTT**.
- Lai izietu no ārkārtas situācijas režīma, nospiediet un turiet pogu **Augša (oranžs)**.

Klusā ārkārtas zvana sūtīšana

- Nospiediet pogu **Augša (oranžs)**.
- Klusā ārkārtas situācijas turpinās, kamēr jūs neīstenojat vienu no šīm darbībām:
 - tieks nospiesta un turēta poga **Augša (oranžs)**, lai atceltu ārkārtas situācijas režīmu;
 - tieks nospiesta un turēta poga **PTT**, lai atceltu klusā ārkārtas situācijas signāla režīmu un aktivizētu parasto pārraides vai ārkārtas situācijas zvana režīmu.

Statusa ikonas

	Akumulatora līmenis		Droša izmantošana
	Saņemtā signāla stipruma indikators (RSSI)		Uzlabotā šifrēšanas standarta (AES) droša darbība
	RSSI saņem		Globālā pozicionēšanas sistēma (GPS)
	RSSI pārraida		Lietotāja pieteikšanās datu indikators (IP paketes dati)
	Tiešais režīms		Datu aktivitāte
	Displejs		Bluetooth®
	Jaudas līmenis augsts		Wi-Fi stiprums
	Jaudas līmenis zems		Mirgojošs/nekustīgs punkts
	Meklēšana		Spēcīga signāla meklēšana
			Savienots ar Bluetooth

Piezīmes

Fontos biztonsági előírások

Rádiófrekvenciás energia kibocsátására és a termékbiztonságra vonatkozó útmutató hordozható rádió-adóvevőkhöz

FIGYELEM!

⚠ FIGYELEM!:

A rádió kizárólag munkavégzéshez használható. A rádió használata előtt olvassa el a Rádiófrekvenciás energia kibocsátására és a termékbiztonságra vonatkozó útmutató hordozható kétirányú rádiókhoz című dokumentumot, amely a biztonságos működtetéssel és a vonatkozó rádiófrekvencia-kibocsátási szabványoknak és előírásoknak való megfeleléssel kapcsolatos fontos tudnivalókat tartalmazza.

A rádió áttekintése

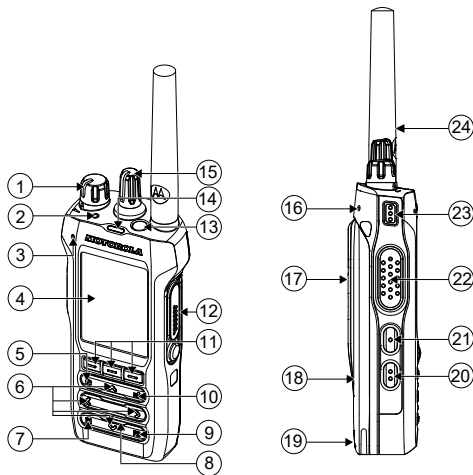

- | | |
|---|--------------------------------|
| 1. Be-/Kikapcsoló/
Hangerőszabályzó gomb | 14 Felső fényszáv |
| 2. Állapot LED | 15 Csatornaválasztó gomb |
| 3. 2. digitális mikrofon | 16 1. digitális mikrofon |
| 4. Kijelző | 17 Ővcsipesz tartókonzolja |
| 5. Kezdőoldal gomb | 18 Akkumulátor |
| 6. Navigációs gombok (4
irányban) | 19 Töltőérintkezők |
| 7. 1. programozható gomb (P1) | 20 2 pontos programozható gomb |
| 8. Hangszóró | 21 1 pontos programozható gomb |
| 9. 2. programozható gomb (P2) | 22 Adógomb (Push-To-Talk, PTT) |
| 10. Értesítés gomb | 23 3 pontos programozható gomb |
| 11. Menüválasztó gombok | 24 Antenna |
| 12. Kiegészítő csatlakozó | |
| 13. Felső (narancs) gomb | |

A rádió be- és kikapcsolása

Az első használat előtt ellenőrizze, hogy az akkumulátor teljesen fel van-e töltve.

A rádió bekapcsolása

Fordítsa el a **Be-/Kikapcsoló/Hangerőszabályzó** gombot az óramutató járásával megegyező irányba kattánásig.

A rádió kikapcsolása

Forgassa el a **Be-/Kikapcsoló/Hangerőszabályzó** gombot az óramutató járásával ellentétes irányba kattánásig.

Zónák és csatornák kiválasztása

Forgassa a **csatornaválasztó** gombot a kívánt csatornára.

Hozzáférés a rádióhívási tevékenységekhez

Végezze el az alábbi műveletek egyikét:

- A hívás indításához nyomja meg és tartsa lenyomva a **PTT** gombot.

- A fogadáshoz engedje fel a **PTT** gombot.
- A hangerő beállításához fordítsa el a **Be-/Kikapcsoló/Hangerőszabályzó** gombot.
- A figyeléshez nyomja meg a programozott **Figyelés** gombot, és figyeljen.

Vészjelzés küldése

1. Nyomja meg hosszan a **felső** (narancssárga) gombot.
A rádió a következő jelzéseket mutatja:

- Jelzőhang hallható.
- A piros LED világít.
- A kijelzőn megjelenik a **felső** (narancssárga) gomb és az aktuális zóna/csatorna.
- A nyugtázás fogadásakor négy sípszó hallható, a riasztás befejeződik, a rádió pedig kilép a vészhívásból

2. Nyomja meg hosszan a **felső** (narancssárga) gombot a vészhívás módból való kilépéshez.

Vészhívás indítása

1. Nyomja meg a **felső** (narancssárga) gombot.
2. Nyomja meg hosszan a **PTT** gombot a beszédhez.
3. A hívás befejezéséhez engedje fel a **PTT** gombot.
4. Nyomja meg hosszan a **felső** (narancssárga) gombot a vészhívás módból való kilépéshez.

Néma vészhívás indítása

1. Nyomja meg a **felső** (narancssárga) gombot.
2. A néma vészhívás addig folytatódik, amíg el nem végzi a következő műveletek egyikét:
 - Nyomja meg hosszan a **felső** (narancssárga) gombot a vészhívási állapotból való kilépéshez.
 - Nyomja meg röviden a **PTT** gombot a néma vészhívás módból való kilépéshez és a normál diszpécser vagy vészhívás módba való belépéshez.

Állapotjelző ikonok

	Akkuszint
	Vételi jelerősség kijelzése (RSSI)
	RSSI-fogadás
	RSSI-adás
	Direkt mód
	Figyelés
	Magas teljesítményszint
	Alacsony teljesítményszint
	Keresés

	Biztonságos üzemeltetés
	Fejlett titkosítási szabványú (AES) biztonságos működés
	Globális helyzetmegállapító rendszer (GPS)
	Felhasználói bejelentkezés jelzőfénye (IP-adatcsomag)
	Adatforgalom
	Bluetooth®
	Wi-Fi erőssége
	Villogó/állandó pont
	Többopciós hálózatkeresés
	Bluetooth csatlakoztatva

Megjegyzések

Belangrijke veiligheidsinformatie

Blootstelling aan radiogolven en productveiligheid voor draagbare radiozondontvangers

LET OP!



LET OP:

Dit apparaat mag alleen beroepsmatig worden gebruikt. Lees vóór gebruik de handleiding Blootstelling aan radiogolven en productveiligheid voor portofoons. Deze bevat belangrijke bedieningsinstructies voor veilig gebruik, beperking van blootstelling aan radiogolven en naleving van de relevante normen en regelgeving.

Overzicht van de portofoon

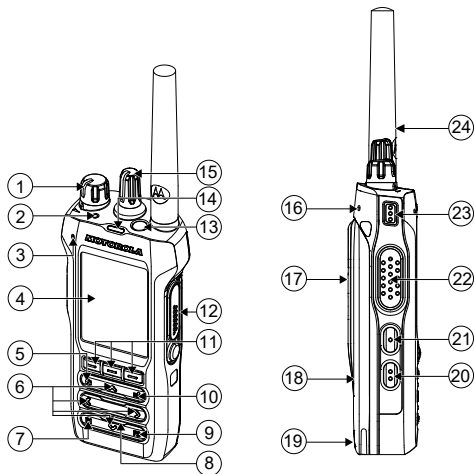

- | | |
|---|---|
| 1. Knop voor aan/uit/
volumeregeling | 14 Bovenste lichtbalk |
| 2. Statuslampje | 15 Kanaalselectieknop |
| 3. Digitale microfoon 2 | 16 Digitale microfoon 1 |
| 4. Display | 17 Riemclip |
| 5. Startknop | 18 Batterij |
| 6. Vierpuntnavigatietoetsen | 19 Contactpunten voor opladen |
| 7. Programmeerbare knop 1
(P1) | 20 Programmeerbare knop met 2
stippen |
| 8. Luidspreker | 21 Programmeerbare knop met 1
stippen |
| 9. Programmeerbare knop 2
(P2) | 22 PTT-knop (Push-to-Talk) |
| 10. Meldingsknop | 23 Programmeerbare knop met 3
stippen |
| 11. Menuselectieknoppen | 24 Antenne |
| 12. Accessoireaansluiting | |
| 13. Bovenste knop (oranje) | |

De portofoon in- en uitschakelen

Zorg ervoor dat de batterij volledig is opgeladen voordat u het apparaat voor het eerst gebruikt.

De portofoon inschakelen

Draai de knop voor **aan/uit/volumeregeling** rechtsom totdat deze vastklikt.

De portofoon uitschakelen

Draai de knop voor **aan/uit/volumeregeling** linksom totdat deze vastklikt.

Zones en kanalen selecteren

Draai de **kanaalselectieknop** naar het gewenste kanaal.

Handelingen voor portofoonoproepen

Voer een van de volgende handelingen uit:

- Als u een oproep wilt plaatsen, houdt u de **PTT**-knop ingedrukt.

- Als u wilt luisteren, laat u de **PTT**-knop los.
- Als u het volume wilt aanpassen, draait u aan de knop voor **aan/uit/volumeregeling**.
- Als u een oproep wilt monitoren, drukt u op de geprogrammeerde knop **Monitoren** om te luisteren.

Een noodoproep verzenden

- Houd de **bovenste knop (oranje)** ingedrukt.

De portofoon geeft de volgende indicaties weer:

- Er klinkt een toon.
- De rode LED brandt.
- Op het display wordt **Top (Orange)** weergegeven, evenals de huidige zone of het huidige kanaal.
- Wanneer de bevestiging is ontvangen, hoort u vier pieptonen, wordt het alarm beëindigd en wordt de noodstand op de portofoon uitgeschakeld.

- Houd de **bovenste knop (oranje)** ingedrukt om de noodstand uit te schakelen.









Een noodoproep verzenden

- Druk op de **bovenste knop (oranje)**.
- Houd de **PTT**-knop ingedrukt om te praten.
- Laat de **PTT**-knop los om de oproep te beëindigen.
- Houd de **bovenste knop (oranje)** ingedrukt om de noodstand uit te schakelen.

Een stille noodoproep verzenden

- Druk op de **bovenste knop (oranje)**.
- De stille noodoproep blijft ingeschakeld totdat u:
 - De **bovenste knop (oranje)** ingedrukt houdt om de noodstand uit te schakelen.
 - De **PTT**-knop ingedrukt houdt om de stille-alarmstand uit te schakelen en de normale zend- of noodoproepstand in te schakelen.

Pictogrammen voor status

	Batterijniveau
	Indicator voor ontvangen signaalsterkte (Received Signal Strength Indicator - RSSI)
	RSSI ontvangst
	RSSI uitzending
	Directe modus
	Monitoren
	Hoog vermogen
	Laag vermogen
	Scannen

	Veilige modus
	Veilige AES-modus (Advanced Encryption Standard)
	Global Positioning System (GPS)
	Indicator voor gebruikersaanmelding (IP-pakketgegevens)
	Gegevensactiviteit
	Bluetooth®
	Sterkte Wi-Fi-signaal
	Knipperend/onafgebroken stip
	Vote-scan
	Bluetooth verbonden

Opmerkingen

Ważne informacje dotyczące bezpieczeństwa

Podręcznik bezpieczeństwa produktu i działania fal radiowych dwukierunkowych radiotelefonów przenośnych

UWAGA!

⚠ PRZESTROGA:

Użytkowanie tego radiotelefonu jest ograniczone wyłącznie do celów zawodowych. Zgodnie z obowiązującymi normami i przepisami przed rozpoczęciem korzystania z urządzenia należy zapoznać się z Podręcznikiem bezpieczeństwa produktu i działania fal radiowych dwukierunkowych radiotelefonów przenośnych, który zawiera instrukcje gwarantujące bezpieczne użytkowanie oraz uwagi dotyczące energii o częstotliwości radiowej.

Przegląd radiotelefonu

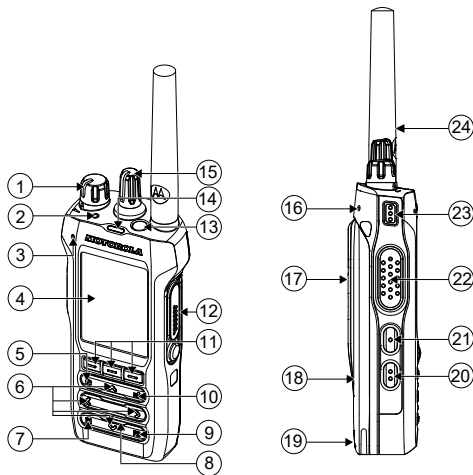

- | | |
|---|--|
| 1. Pokrętko regulacji głośności/zasilania | 14 Górny wskaźnik na pasku |
| 2. Stan LED | 15 Pokrętko wyboru kanałów |
| 3. Mikrofon cyfrowy 2 | 16 Cyfrowy mikrofon 1 |
| 4. Wyświetlacz | 17 Wspornik zaczepu na pasek |
| 5. Przycisk Ekranu głównego | 18 Akumulator |
| 6. 4-kierunkowe przyciski nawigacyjne | 19 Styki ładujące |
| 7. Przycisk programowalny 1 (P1) | 20 Programowalny przycisk z 2 kropkami |
| 8. Głośnik | 21 Programowalny przycisk z 1 kropkami |
| 9. Przycisk programowalny 2 (P2) | 22 Przycisk Push-To-Talk (PTT) |
| 10. Przycisk powiadomień | 23 Programowalny przycisk z 3 kropkami |
| 11. Przyciski wyboru menu | 24 Antena |
| 12. Złącze akcesoriów | |
| 13. Górny (pomarańczowy) przycisk | |

Włączanie lub wyłączanie radiotelefonu

Upewnij się, że akumulator jest w pełni naładowany przed pierwszym użyciem.

Włączanie radiotelefonu

Obróć pokrętko **głośności/zasilania** w kierunku zgodnym z ruchem wskazówek zegara, aż do kliknięcia.

Wyłączanie radiotelefonu

Obróć pokrętko **głośności/zasilania** w kierunku przeciwnym do ruchu wskazówek zegara, aż do kliknięcia.

Wybór stref i kanałów

Obróć pokrętko **wyboru kanałów**, aby ustawić żądany kanał.

Uzyskiwanie dostępu do aktywności połączeń radiotelefonu

Wykonaj jedną z następujących czynności:

- Aby zadzwonić, naciśnij i przytrzymaj przycisk **PTT**.
- Aby słuchać, zwolnij przycisk **PTT**.
- Aby dostosować głośność, obróć pokrętko **głośności/zasilania**.
- Aby nasłuchiwać, naciśnij zaprogramowany przycisk **Nasłuch** i słuchaj.

Wysyłanie informacji alarmowej

1. Naciśnij i przytrzymaj przycisk **górnny (pomarańczowy)**. Sygnalizacja na radiotelefonie jest następująca:
 - Emitowany jest dźwięk.
 - Świeci się czerwona dioda LED.
 - Na ekranie przedstawiono przycisk **górnny (pomarańczowy)** wraz z bieżącą strefą/kanałem.
 - Po otrzymaniu potwierdzenia usłyszysz cztery sygnały, skończy się alarm i radiotelefon wyjdzie z trybu awaryjnego.
2. Naciśnij i przytrzymaj przycisk **górnny (pomarańczowy)**, aby wyjść z trybu alarmowego.

Wysyłanie połączenia alarmowego



















1. Naciśnij przycisk **górnny (pomarańczowy)**.
2. Naciśnij i przytrzymaj przycisk **PTT**, a następnie mów do mikrofonu.
3. Zwolnij przycisk **PTT**, aby zakończyć rozmowę.
4. Naciśnij i przytrzymaj przycisk **górnny (pomarańczowy)**, aby wyjść z trybu alarmowego.

Wysyłanie cichego połączenia alarmowego

1. Naciśnij przycisk **górnny (pomarańczowy)**.
2. Cichy alarm trwa do momentu wykonania jednej z następujących czynności:
 - Naciśnij i przytrzymaj przycisk **górnny (pomarańczowy)**, aby opuścić stan alarmowy.

- Naciśnij i zwolnij przycisk **PTT**, aby wyjść z trybu cichego alarmu i przejść do trybu normalnego lub do trybu połączenia alarmowego.

Ikony stanu

	Poziom naładowania akumulatora		Skanowanie
	Wskaźnik siły odbieranego sygnału (RSSI)		Praca w trybie bezpiecznym
	RSSI odbioru		Praca w trybie bezpiecznym AES (Advanced Encryption Standard)
	RSSI nadawania		System GPS (Global Positioning System)
	Tryb DMO		Wskaźnik logowania użytkownika (Dane pakietu IP)
	Nasłuch		Aktywność danych
	Wysoki poziom mocy		Bluetooth®
	Niski poziom mocy		Siła sygnału Wi-Fi
			Migająca/statyczna kropka
			Skanowanie głosujące



Połączenie Bluetooth

Informações importantes de segurança

Guia de segurança do produto e de exposição a energia de RF para rádios bidirecionais portáteis

ATENÇÃO!

⚠ ATENÇÃO:

Este rádio destina-se apenas a utilização profissional. Antes de utilizar o rádio, leia o Guia de segurança do produto e de exposição a energia de RF para rádios bidirecionais portáteis, que contém instruções de funcionamento importantes para uma utilização segura e informações sobre como conhecer e controlar a sua exposição a energia de RF, a fim de respeitar as normas e os regulamentos aplicáveis.

Visão geral do rádio

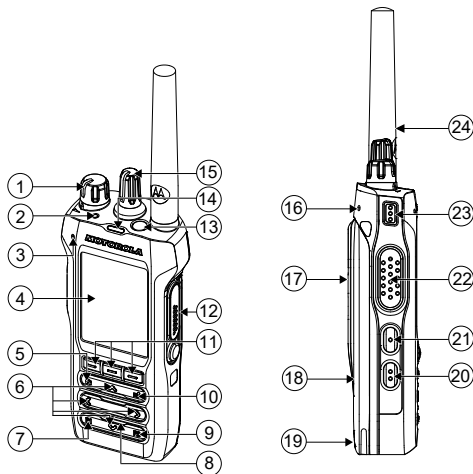

- | | |
|--|----------------------------------|
| 1. Botão de controlo Ligar/Desligar/Volume | 14 Barra de luz superior |
| 2. LED de estado | 15 Botão de seleção de canais |
| 3. Microfone digital 2 | 16 Microfone digital 1 |
| 4. Ecrã | 17 Suporte da mola de cinto |
| 5. Botão de início | 18 Bateria |
| 6. Botões de navegação de 4 vias | 19 Contactos de carregamento |
| 7. Botão programável 1 (P1) | 20 Botão programável de 2 pontos |
| 8. Altifalante | 21 Botão programável de 1 ponto |
| 9. Botão programável 2 (P2) | 22 Botão Push-To-Talk (PTT) |
| 10. Botão de notificação | 23 Botão programável de 3 pontos |
| 11. Botões de seleção do menu | 24 Antena |
| 12. Conetor para acessórios | |
| 13. Botão superior (laranja) | |

Ligar ou desligar o rádio

Certifique-se de que a bateria está totalmente carregada antes da primeira utilização.

Ligar o rádio

Rode o botão de **controlo Ligar/Desligar/Volume** para a direita até encaixar.

Desligar o rádio

Rode o botão de **controlo Ligar/Desligar/Volume** para a esquerda até encaixar.

Selecionar a zona e o canal

Rode o botão de **seleção de canais** para o canal pretendido.

Aceder a atividades de chamadas de rádio

Execute uma das seguintes ações:

- Para efetuar a chamada, prima continuamente o botão **PTT**.
- Para ouvir, solte o botão **PTT**.

- Para ajustar o volume, rode o botão de **controlo Ligar/Desligar/Volume**.
- Para monitorizar, prima o botão **Monitorizar** programado e ouça.

Enviar um alarme de emergência

1. Mantenha premido o botão **superior (laranja)**.
O rádio apresenta as seguintes indicações:
 - É emitido um tom.
 - O LED vermelho acende-se.
 - O ecrã apresenta a mensagem **superior (laranja)** e a zona/canal atual.
 - Quando a confirmação for recebida, ouvirá quatro sinais sonoros, o alarme termina e o rádio sai do estado de emergência.
2. Mantenha premido o botão **superior (laranja)** para sair do estado de emergência.

Enviar uma chamada de emergência

1. Prima o botão **superior (laranja)**.
2. Mantenha premido o botão **PTT** para falar.
3. Solte o botão **PTT** para terminar a chamada.
4. Mantenha premido o botão **superior (laranja)** para sair do estado de emergência.

Enviar uma chamada de emergência silenciosa

1. Prima o botão **superior (laranja)**.
2. A chamada de emergência silenciosa continua até realizar uma das seguintes ações:
 - Mantenha premido o botão **superior (laranja)** para sair do estado de emergência.
 - Prima e solte o botão **PTT** para sair do modo Alarme de emergência silencioso e entrar na distribuição normal ou no modo Chamada de emergência.

Ícones de estado



Nível da bateria



Indicador de intensidade do sinal recebido (RSSI)



Receção RSSI



Transmissão RSSI



Modo direto



Monitorizar



Nível de potência elevado



Nível de potência baixo



Procurar



Operação segura



Operação segura do AES (Advanced Encryption Standard)



Sistema de posicionamento global (GPS)



Indicador de início de sessão do utilizador (pacote de dados de IP)



Atividade de dados



Bluetooth®



Intensidade do Wi-Fi



Ponto intermitente/contínuo



Procura por votação



Bluetooth ligado

Notas

Informații importante privind siguranța

Ghid de siguranță și privind expunerea la energie de radiofrecvență (RF) pentru stațiile radio portabile de emisie-recepție

ATENȚIE!

⚠ ATENȚIE:

Această stație radio este destinată exclusiv uzului profesional.

Înainte de a utiliza stația radio, citiți Ghidul privind siguranța produsului și expunerea la energia de radiofrecvență (RF) pentru stațiile radio portabile de emisie-recepție. Acesta conține instrucțiuni de operare importante pentru utilizarea sigură și familiarizarea cu și controlul energiei de radiofrecvență (RF) în vederea respectării standardelor și reglementărilor aplicabile.

Prezentare generală a stației radio

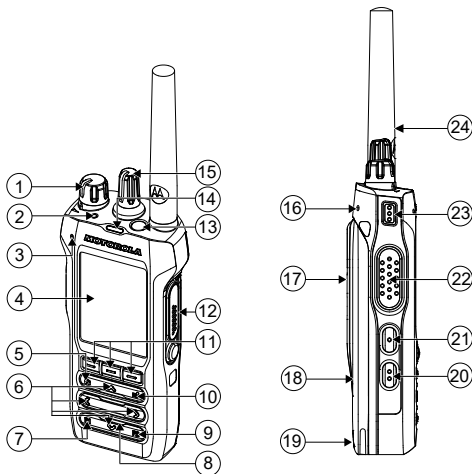

1. Buton rotativ de pornire/oprire/control al volumului
2. LED de stare
3. Microfon digital 2
4. Ecran
5. Buton Ecran de pornire
6. Butoane de navigare în 4 direcții
7. Buton programabil 1 (P1)
8. Difuzor
9. Buton programabil 2 (P2)
10. Buton de notificare
11. Butoane de selectare a meniului
12. Conector de accesorii
13. Buton superior (portocaliu)
- 14 Bară luminoasă superioară
- 15 Buton rotativ de selectare a canalului
- 16 Microfon digital 1
- 17 Suport clemă de curea
- 18 Baterie
- 19 Contacte de încărcare
- 20 Buton programabil cu 2 puncte
- 21 Buton programabil cu 1 puncte
- 22 Buton PTT (Apasă și vorbește)
- 23 Buton programabil cu 3 puncte
- 24 Antenă

- Pentru a asculta, eliberați butonul **PTT**.
- Pentru a regla volumul, rotiți butonul de **pornire/oprire/control al volumului**.
- Pentru a monitoriza, apăsați butonul **Monitorizare** programat și ascultați.

Trimiterea unei alarme de urgență

1. Apăsați și țineți apăsat butonul **superior (portocaliu)**. Stația dvs. radio afișează următoarele indicații:
 - Se emite un ton sonor.
 - Ledul roșu se aprinde.
 - Afișajul indică **Superior (portocaliu)** și zona/canalul curent(ă).
 - La primirea confirmării, veți auzi patru tonuri sonore scurte; alarma se oprește și stația radio iese din starea de urgență.
2. Apăsați și țineți apăsat butonul **superior (portocaliu)** pentru a ieși din starea de urgență.

Efectuarea unui apel de urgență

1. Apăsați butonul **superior (portocaliu)**.
2. Apăsați și țineți apăsat butonul **PTT** pentru a vorbi.
3. Pentru a termina apelul, eliberați butonul **PTT**.
4. Apăsați și țineți apăsat butonul **superior (portocaliu)** pentru a ieși din starea de urgență.

Trimiterea unui apel de urgență silențios

1. Apăsați butonul **superior (portocaliu)**.
2. Modul de urgență silențios continuă până când efectuați una dintre următoarele acțiuni:
 - Apăsați și țineți apăsat butonul **superior (portocaliu)** pentru a ieși din starea de urgență.
 - Apăsați și eliberați butonul **PTT** pentru a ieși din modul Alarmă de urgență silențioasă și a intra în modul de trimitere normală sau în modul Apel de urgență.

Pornirea sau oprirea stației radio

Asigurați-vă că bateria este complet încărcată înainte de prima utilizare.

Pornirea stației radio

Rotiți butonul de **pornire/oprire/control al volumului** spre dreapta până se aude un clic.

Oprirea stației radio

Rotiți butonul de **pornire/oprire/control al volumului** spre stânga până se aude un clic.

Selectarea zonelor și a canalelor



















Rotiți butonul de **selectare a canalului** până ajungeți la canalul dorit.

Accesarea activităților de apel radio

Efectuați una dintre următoarele acțiuni:

- Pentru apelare, apăsați și țineți apăsat butonul **PTT**.

Pictograme de stare

	Nivelul bateriei		Funcționare securizată
	Indicator de intensitate a semnalului recepționat (RSSI)		Funcționare securizată cu standard de criptare avansată (AES)
	Recepție RSSI		Sistem de poziționare globală (GPS)
	Transmisie RSSI		Indicator conectare utilizator (Date IP în pachete)
	Mod direct		Activitate de date
	Monitor		Bluetooth®
	Nivel de putere ridicat		Putere Wi-Fi
	Nivel de putere scăzut		Punct intermitent/constant
	Scanare		Funcție de selectare a repetorului cu semnal maxim
			Bluetooth conectat

Note

Dôležité bezpečnostné informácie

Príručka bezpečného používania prenosnej vysielajúcej a vystavenia organizmu rádiovým žiarením

UPOZORNENIE!

⚠ POZOR:

Táto vysielajúca je určená na používanie iba na pracovné účely.

Pred použitím vysielajúcej si prečítajte Príručku bezpečného používania prenosnej vysielajúcej a vystavenia organizmu rádiovým žiarením, ktorá obsahuje dôležité pokyny týkajúce sa prevádzky a bezpečného používania, ako aj informácie o rádiovom žiarení a súlade s príslušnými normami a predpismi.

Prehľad vysielajúcej

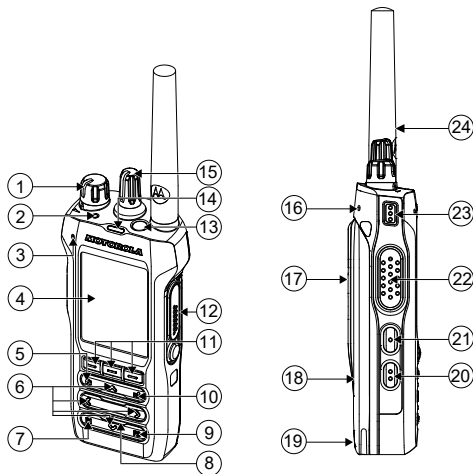

1. Otočný ovládač ZAP/VYP/ ovládanie hlasitosti
2. Stav LED
3. Digitálny mikrofón 2
4. Displej
5. Tlačidlo Domov
6. 4-cestné navigačné tlačidlá
7. Programovateľné tlačidlo 1 (P1)
8. Reproduktor
9. Programovateľné tlačidlo 2 (P2)
10. Tlačidlo oznámenia
11. Tlačidlá výberu ponuky
12. Konektor pre príslušenstvo
13. Horné (oranžové) tlačidlo
14. Horná svetelná lišta
15. Otočný ovládač na výber kanálov
16. Digitálny mikrofón 1
17. Spona držiaka na opasok
18. Batéria
19. Nabíjacie kontakty
20. 2-bodkové programovateľné tlačidlo
21. 1-bodkové programovateľné tlačidlo
22. Tlačidlo Push-to-Talk (PTT)
23. 3-bodkové programovateľné tlačidlo
24. Anténa

Zapnutie alebo vypnutie vysielacky

Pred prvým použitím sa uistite, že je batéria plne nabitá.

Zapnutie vysielacky

Otočte **Otočný ovládač ZAP/VYP/ovládanie hlasitosti** v smere hodinových ručičiek, kým nezacvakne.

Vypnutie vysielacky

Otočný ovládač ZAP/VYP/ovládanie hlasitosti otáčajte proti smeru hodinových ručičiek dovtedy, kým nezacvakne.

Výber zón a kanálov

Otočte otočný ovládač **Výber kanálov** na požadovaný kanál.

Prístup k činnostiam volaní cez vysielacku

Vykonajte jeden z nasledujúcich krokov:

- Ak chcete volať, stlačte a podržte tlačidlo **PTT**.
- Ak chcete počúvať, uvoľnite tlačidlo **PTT**.

- Ak chcete upraviť hlasitosť, otočte **Otočný ovládač ZAP/VYP/ ovládanie hlasitosti**.
- Ak chcete monitorovať, stlačte naprogramované tlačidlo **Monitorovať** a počúvajte.

Odoslanie pohotovostného alarmu

1. Stlačte a podržte **Horné (oranžové)** tlačidlo. Vaša vysielacka zobrazuje nasledujúce indikácie:
 - Zaznie zvuk.
 - Rozsvieti sa červený indikátor LED.
 - Na displeji sa zobrazí **Horné (oranžové)** spolu s aktuálnou zónou/kanálom.
 - Po prijatí potvrdenia sa ozvú štyri pípnutia, alarm skončí a vysielacka ukončí pohotovostný režim
2. Stlačením a podržaním **Horného (oranžového)** tlačidla ukončíte pohotovostný režim.



















Uskutočnenie tiesňového volania

1. Stlačte **Horné (oranžové)** tlačidlo.
2. Ak chcete rozprávať, stlačte a podržte tlačidlo **PTT**.
3. Hovor ukončíte uvoľnením tlačidla **PTT**.
4. Stlačením a podržaním **Horného (oranžového)** tlačidla ukončíte pohotovostný režim.

Uskutočnenie tichého tiesňového volania

1. Stlačte **Horné (oranžové)** tlačidlo.
2. Tiché tiesňové volanie pokračuje dovtedy, kým nevykonáte jednu z nasledujúcich akcií:
 - Stlačením a podržaním **Horného (oranžového)** tlačidla ukončíte pohotovostný stav.
 - Stlačením a uvoľnením tlačidla **PTT** ukončíte tichý pohotovostný režim a prejdete do bežného dispečerského alebo pohotovostného režimu.

Stavové ikony

	Úroveň nabitia batérie		Bezpečná prevádzka štandardu pokročilého šifrovania (AES)
	Indikátor intenzity prijímaného signálu (RSSI)		Globálny pozičný systém (GPS)
	Prijímanie RSSI		Indikátor prihlásenia používateľa (údaje IP paketu)
	Vysielanie RSSI		Dátová aktivita
	Priamy režim		Bluetooth®
	Monitor		Intenzita siete Wi-Fi
	Vysoká úroveň výkonu		Blikajúca/svietiaca bodka
	Nízka úroveň výkonu		Skenovania hlasovania
	Skenovať		Bluetooth pripojený
	Bezpečná prevádzka		

Poznámky

Tärkeitä turvallisuustietoja

Radiotaajuusenergialle altistuminen ja tuoteturvallisuus kannettavien radiopuhelinten käytössä -opas

HUOMIO!

⚠ HUOMIO:

Tämä radiopuhelin on tarkoitettu vain ammattikäyttöön. Ennen kuin käytät tätä radiopuhelinta, lue Radiotaajuusenergialle altistuminen ja tuoteturvallisuus kannettavien radiopuhelinten käytössä -opas. Se sisältää tärkeää tietoa turvallisesta käytöstä sekä radiotaajuusenergialle altistumisen valvonnasta, jotta soveltuvia standardeja ja säädöksiä noudatetaan.

Radiopuhelimen yleiskuvaus

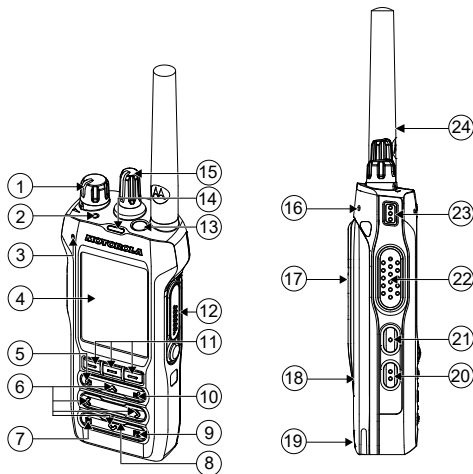

- | | |
|---|-------------------------------------|
| 1. Virta-/
äänenvoimakkuusnuppi | 14 Yläreunan valopalkki |
| 2. Tilan merkkivalo | 15 Kanavanvalintanuppi |
| 3. Digitaalinen mikrofoni 2 | 16 Digitaalinen mikrofoni 1 |
| 4. Näyttö | 17 Vyöpidike |
| 5. Aloitusnäyttöpainike | 18 Akku |
| 6. 4-suuntaiset
navigointipainikkeet | 19 Latauskontaktit |
| 7. Ohjelmoitava painike 1 (P1) | 20 2-pisteinen ohjelmoitava painike |
| 8. Kaiutin | 21 1-pisteinen ohjelmoitava painike |
| 9. Ohjelmoitava painike 2 (P2) | 22 Push-to-Talk (PTT) -painike |
| 10. Ilmoituspainike | 23 3-pisteinen ohjelmoitava painike |
| 11. Valikon valintapainikkeet | 24 Antenni |
| 12. Lisävarusteliitäntä | |
| 13. Yläpainike (oranssi) | |

Radiopuhelimen käynnistäminen ja sammuttaminen

Varmista ennen ensimmäistä käyttöä, että akku on ladattu täyteen.

Radiopuhelimen käynnistäminen

Käännä **virta-/äänenvoimakkuusnuppia** myötöpäivään, kunnes kuulet napsahduksen.

Radiopuhelimen sammuttaminen

Käännä **virta-/äänenvoimakkuusnuppia** vastapäivään, kunnes kuulet napsahduksen.

Alueen ja kanavan valitseminen

Käännä **kanavanvalintanuppi** halutulle kanavalle.

Radiopuhelutoimintojen käyttäminen

Tee jokin seuraavista:

- Soita pitämällä **PTT**-painiketta painettuna.
- Kuuntele vapauttamalla **PTT**-painike.

- Säädä äänenvoimakkuutta kääntämällä **virta-/äänenvoimakkuusnuppia**.
- Tarkkaile painamalla **Tarkkailu**-painiketta ja kuuntelemalla.

Hätäkutsun lähettäminen

1. Pidä **yläpainiketta (oranssi)** painettuna.

Radiopuhelin toimii seuraavasti:

- Kuulet merkkiäänen.
 - Punainen LED-merkkivalo syttyy.
 - Näyttöön tulee teksti **Top (Orange)** (yläpainike [oranssi]) sekä nykyinen alue/kanava.
 - Kun laite vastaanottaa kuittauksen, se antaa neljä äänimerkkiä, hälytys päättyy ja laite poistuu hätäkutsutilasta.
2. Poistu hätäkutsutilasta pitämällä **yläpainiketta (oranssi)** painettuna.



















Hätäpuhelun soittaminen

1. Paina **yläpainiketta (oranssi)**.
2. Puhu pitämällä **PTT**-painiketta painettuna.
3. Voit lopettaa puhelun vapauttamalla **PTT**-painikkeen.
4. Voit lopettaa hätäpuhelun pitämällä **yläpainiketta (oranssi)** painettuna.

Hiljaisen hätäpuhelun lähettäminen

1. Paina **yläpainiketta (oranssi)**.
2. Hiljainen hätätilannetila jatkuu, kunnes teet jotain seuraavista:
 - Poistu hätätilannetilasta pitämällä **yläpainiketta (oranssi)** painettuna.
 - Paina **PTT**-painiketta ja vapauta se, jolloin laite poistuu hiljaisesta hätätilannetilasta ja siirtyy tavalliseen tehtävä- tai hätäpuhelutilaan.

Tilakuvakkeet

	Akun varaustaso		AES-suojattu toiminta
	Vastaanotetun signaalin voimakkuuden ilmaisin (RSSI)		GPS (Global Positioning System)
	RSSI-vastaanotto		Käyttäjän kirjautumisilmaisain (IP-pakettidata)
	RSSI-lähetys		Dataliikenne
	Suora tila		Bluetooth®
	Tarkkailu		Wi-Fi-yhteyden voimakkuus
	Korkea tehotaso		Vilkkuva / jatkuvasti näkyvä piste
	Matala tehotaso		Äänestyskannaus
	Haku		Bluetooth yhdistetty
	Suojattu toiminta		

Huomautukset

Viktig säkerhetsinformation

Produktsäkerhetshandbok om RF-exponering för bärbara tvåvägsradioenheter

OBS!

⚠ FÖRSIKTIGT:

Den här radion är endast avsedd för yrkesmässig användning. Innan du använder radion bör du läsa produktsäkerhetshandboken om RF-exponering för bärbara tvåvägsradioenheter. Den innehåller instruktioner om säker användning, information om RF-energi och kontroller för efterlevnad av tillämpliga standarder och föreskrifter.

Radioöversikt

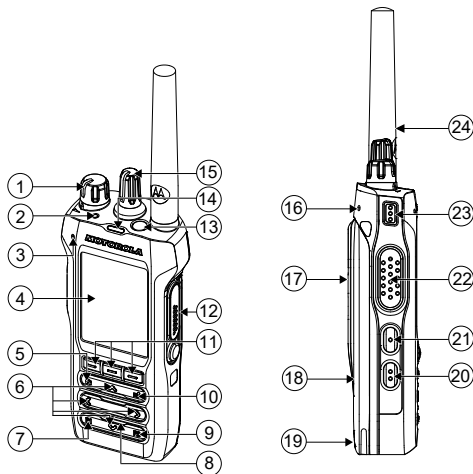

- | | |
|-------------------------------|--------------------------------|
| 1. Ratt för på/av/volym | 14 Övre ljusfält |
| 2. Statuslysdiod | 15 Kanalvalsrott |
| 3. Digital mikrofon 2 | 16 Digital mikrofon 1 |
| 4. Teckenfönster | 17 Fäste för bältesklämma |
| 5. Hemknapp | 18 Batteri |
| 6. 4-vägs navigeringsknappar | 19 Laddningskontakter |
| 7. Programmerbar knapp 1 (P1) | 20 Programmerbar 2-punktsknapp |
| 8. Högtalare | 21 Programmerbar 1-punktsknapp |
| 9. Programmerbar knapp 2 (P2) | 22 Push-to-Talk-knapp (PTT) |
| 10. Meddelandeknapp | 23 Programmerbar 3-punktsknapp |
| 11. Menyvalsknappar | 24 Antenn |
| 12. Tillbehörskontakt | |
| 13. Övre (orange) knapp | |

Slå på eller stänga av radion

Se till att batteriet är fulladdat före första användning.

Slå på radion

Vrid på ratten för **på/av/volym** medurs tills den klickar.

Stänga av radion

Vrid på ratten för **på/av/volym** moturs tills den klickar.

Välja zoner och kanaler

Vrid **kanalvalsratten** till önskad kanal.

Gå till radiosamtalsaktiviteter

Utför någon av följande åtgärder:

- Ring genom att trycka på och hålla ned knappen **PTT**.
- Släpp knappen **PTT** för att lyssna.
- Anpassa volymen genom att vrida ratten för **på/av/volym**.

- För att övervaka trycker du på den programmerade knappen för **övervakning** och lyssnar.

Skicka ett nödlarm

1. Håll den **övre (orange)** knappen nedtryckt. Radion visar följande indikationer:
 - En signal hörs.
 - Den röda lysdioden tänds.
 - I teckenfönstret visas **övre (orange)** och aktuell zon/kanal.
 - När meddelandet mottagits kommer du att höra fyra pip, sedan slutar larmet och radion går ur nödläget
2. Håll den **övre (orange)** knappen nedtryckt när du vill avbryta nödläge.

Skicka ett nödanrop

1. Tryck på den **övre (orange)** knappen.
2. Håll **PTT**-knappen nedtryckt för att prata.
3. Släpp **PTT**-knappen när du vill avsluta anropet.
4. Håll den **övre (orange)** knappen nedtryckt när du vill avbryta nödläge.

Skicka ett ljudlöst nödanrop

1. Tryck på den **övre (orange)** knappen.
2. Tyst nödläge fortsätter tills du gör något av följande:
 - Håll den **övre (orange)** knappen nedtryckt när du vill avbryta nödläge.
 - Tryck på och släpp **PTT**-knappen för att avsluta ljudlöst nödläge och återgå till läge för normal sändning eller nödanropsläge.

Statusikoner



Batterinivå

	Mottagen signalstyrkeindikator (RSSI)
	RSSI-mottagning
	RSSI-sändning
	Direktläge
	Övervaka
	Hög effektnivå
	Låg effektnivå
	Skanna
	Skyddat driftsläge
	AES-skyddat driftsläge (Advanced Encryption Standard)

	GPS (Global Positioning System)
	Indikator för användarinloggning (IP-paketdata)
	Dataaktivitet
	Bluetooth®
	Wi-Fi-styrka
	Blinkande/fast punkt
	Vote Scan
	Bluetooth-anslutningen utfördes

Anteckningar

Önemli Güvenlik Bilgileri

Çift Yönlü Portatif Telsizler İçin RF Enerjisine Maruz Kalma ve Ürün Güvenlik Kılavuzu

DİKKAT!



DİKKAT:

Bu telsiz yalnızca İş Amaçlı kullanımla sınırlıdır. Telsizi kullanmadan önce yürürlükteki standartlar ve Yönetmelikler uyarınca güvenli kullanım ile RF enerjisi farkındalığı ve kontrolü açısından önem arz eden kullanım talimatları içeren Portatif Çift Yönlü Telsizler İçin RF Enerjisine Maruz Kalma ve Ürün Güvenlik Kılavuzunu okuyun.

Telsize Genel Bakış

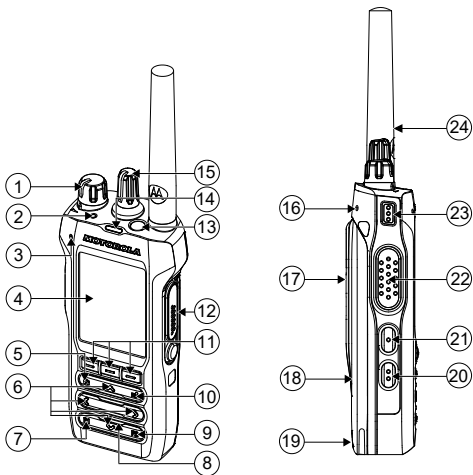

1. Açma/Kapatma/Ses Kontrol topuzu
2. Durum LED'i
3. Dijital Mikrofon 2
4. Ekran
5. Ana ekran düğmesi
6. 4 Yönlü Navigasyon düğmeleri
7. Programlanabilir düğme 1 (P1)
8. Hoparlör
9. Programlanabilir düğme 2 (P2)
10. Bildirim düğmesi
11. Menü Seçim düğmeleri
12. Aksesuar Konektörü
13. Üst (Turuncu) düğme
14. Üst Işık Çubuğu
15. Kanal Seçim topuzu
16. Dijital Mikrofon 1
17. Kemer Klipsi Braketi
18. Batarya
19. Şarj Temas Noktaları
20. 2 Noktalı Programlanabilir düğme
21. 1 Noktalı Programlanabilir düğme
22. Bas Konuş (PTT) düğmesi
23. 3 Noktalı Programlanabilir düğme
24. Anten

Telsizi Açma veya Kapatma

İlk kullanımdan önce bataryanın tamamen şarj edildiğinden emin olun.

Telsizi Açma

Açma/Kapatma/Ses Kontrol topuzunu klik sesini duyana kadar saat yönünde döndürün.

Telsizi Kapatma

Açma/Kapatma/Ses Kontrol topuzunu klik sesini duyana kadar saat yönünün tersine döndürün.

Bölgeleri ve Kanalları Seçme

Kanal Seçim topuzunu istediğiniz Kanala döndürün.

Telsiz Çağrısı Etkinliklerine Erişme

Aşağıdaki eylemlerden birini gerçekleştirin:

- Çağrı başlatmak için **PTT** düğmesini basılı tutun.

- Dinlemek için **PTT** düğmesini bırakın.
- Ses düzeyini ayarlamak için **Açma/Kapatma/Ses Kontrol** topuzunu döndürün.
- İzlemek için programlanmış **İzleme** düğmesine basın ve dinleyin.

Acil Durum Alarmı Gönderme

1. Üst (Turuncu) düğmeyi basılı tutun.

Telsizinizde aşağıdaki göstergeler ortaya çıkar:

- Bir ton duyulur.
- Kırmızı LED yanar.
- Ekranda **Üst (Turuncu)** yazısı ve mevcut bölge/kanal görüntülenir.
- Onay alındıktan sonra dört bip sesi duyarsınız alarm durur ve telsiz acil durumdan çıkar

2. Acil durumdan çıkmak için **Üst (Turuncu)** düğmeyi basılı tutun.

Acil Durum Çağrısı Gönderme

1. Üst (Turuncu) düğmeye basın.

2. Konuşmak için **PTT** düğmesini basılı tutun.

3. Çağrıyla sonlandırmak için **PTT** düğmesini bırakın.

4. Acil durumdan çıkmak için **Üst (Turuncu)** düğmeyi basılı tutun.



















Sessiz Acil Durum Çağrısı Gönderme

1. Üst (Turuncu) düğmeye basın.

2. Sessiz acil durum, aşağıdakilerden biri gerçekleştirilene kadar devam eder:

- Acil durumdan çıkmak için **Üst (Turuncu)** düğmeyi basılı tutun.
- Sessiz Acil Durum modundan çıkmak ve normal sevk veya Acil Durum Çağrısı moduna geçmek için **PTT** düğmesine basıp bırakın.

Durum Simgeleri

	Batarya Seviyesi		Gelişmiş Şifreleme Standardı (AES) Güvenli İşlemi
	Alınan Sinyal Güç Göstergesi (RSSI)		Küresel Konumlandırma Sistemi (GPS)
	RSSI Alınıyor		Kullanıcı Oturumu Göstergesi (IP Paket Verisi)
	RSSI İletiliyor		Veri Etkinliği
	Doğrudan Mod		Bluetooth®
	İzleme		Wi-Fi Gücü
	Güç Seviyesi Yüksek		Yanıp Sönen/Sabit Nokta
	Güç Seviyesi Düşük		Oylamalı Tarama
	Tarama		Bluetooth Bağlı
	Güvenli İşlem		

Notlar

הערות

מחונן לכניסת משתמש (נתוני מנת IP)



פעילות נתונים



Bluetooth®



עוצמת ה-Wi-Fi



נקודה קבועה/מהבהבת



סריקת הצבעה



יש חיבור Bluetooth



קבלת RSSI



שידור RSSI



מצב ישיר



צג



רמת הספק גבוהה



רמת הספק נמוכה



סריקה



פעולה מאובטחת



הפעלה מאובטחת - תקן הצפנה מתקדם (AES)



מערכת מיקום גלובלית (GPS)



- כדי לנטר, לחץ על הלחצן המתוכנת **ניטור** והאזן.

שליחת התראת חירום

1. לחץ לחיצה ארוכה על הלחצן **עליון (כתום)**.
מכשיר הקשר מציג את החיוויים הבאים:
 - נשמע צליל.
 - הנורית האדומה מהבהבת.
 - התצוגה מראה את הכיתוב **עליון (כתום)** ואת האזור/ערוץ הנוכחי.
 - כאשר מתקבל אישור, נשמעים ארבעה צלילי צפצוף, ההתראה מסתיימת והרדיו יוצא ממצב חירום
2. לחץ לחיצה ממושכת על לחצן **עליון (כתום)** כדי לצאת ממצב החירום.

שליחת שיחת חירום

1. לחץ על לחצן **עליון (כתום)**.
2. לחץ לחיצה ממושכת על הלחצן **PTT** כדי לדבר.
3. שחרר את לחצן **PTT** כדי לסיים את השיחה.
4. לחץ לחיצה ממושכת על לחצן **עליון (כתום)** כדי לצאת ממצב החירום.

שליחת שיחת חירום שקטה

1. לחץ על לחצן **עליון (כתום)**.
2. דמציב החירום השקט יימשך עד שתבצע אחת מהפעולות הבאות:
 - לחץ לחיצה ממושכת על לחצן **עליון (כתום)** כדי לצאת ממצב החירום.
 - לחץ על הלחצן **PTT** ושחרר אותו כדי לצאת ממצב התראת החירום השקטה ולהיכנס למצב שידור רגיל או למצב שיחת חירום.

ממלי מצב

רמת סוללה



מחון עוצמת אות קליטה (RSSI)



1. כפתור הפעלה/כיבוי/בקרת עוצמת קול
2. נורית חיווי LED
3. מיקרופון דיגיטלי 2
4. תצוגה
5. לחצן 'בית'
6. לחצני ניווט 4-כיווני
7. לחצן ניתן לתכנות 1 (P1)
8. רמקול
9. לחצן ניתן לתכנות 2 (P2)
10. לחצן התראה
11. לחצני בחירת תפריט
12. מחבר אביזרים
13. לחצן עליון (כתום)

הפעלה וכיבוי של מכשיר הקשר

ודא שהסוללה טעונה במלואה לפני השימוש הראשון.

הפעלת הרדיו

סובב את כפתור הפעלה/כיבוי/בקרת עוצמת קול בכיוון השעון עד להישמע צליל נקישה.

כיבוי הרדיו

סובב את כפתור הפעלה/כיבוי/בקרת עוצמת קול נגד כיוון השעון עד להישמע צליל נקישה.

בחירת אזורים וערוצים

סובב את כפתור בורר הערוצים לערוץ הרצוי.

גישה לפעילויות שיחות רדיו

- בצע אחת מהפעולות הבאות:
- כדי להתקשר, לחץ לחיצה ארוכה על הלחצן **PTT**.
 - כדי להאזין, שחרר את הלחצן **PTT**.
 - כדי לכוון את עוצמת הקול, סובב את כפתור הפעלה/כיבוי/בקרת עוצמת קול.

סקירה כללית של מכשיר הקשר

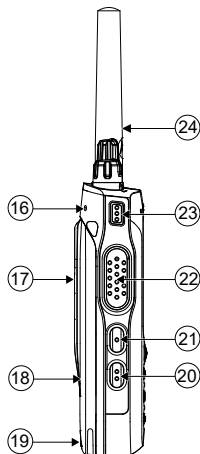
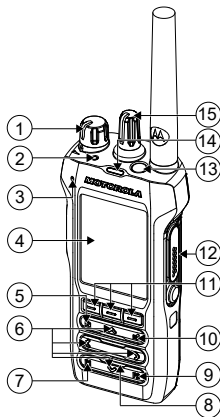

מידע חשוב בנושאי בטיחות

מדריך בנושא חשיפה לאנרגיית ת"ר ובטיחות המוצר עבור התקני רדיו דו-כיווניים
נישאים

שים לב!

זהירות:



השימוש במכשיר קשר זה מוגבל לצורכי עבודה בלבד. לפני השימוש ברדיו, קרא את מדריך בנושא חשיפה לאנרגיית ת"ר ובטיחות המוצר עבור התקני רדיו דו-כיווניים נישאים, המכיל הוראות הפעלה חשובות לשימוש בטוח, למודעות לאנרגיית ת"ר ולבקרה על אנרגיית ת"ר, לצורך עמידה בתקנים ובתקנות הרלוונטיים.



https://learning.motorolasolutions.com/User_Documentation



MOTOROLA, MOTO, MOTOROLA SOLUTIONS and the Stylized M logo are trademarks or registered trademarks of Motorola Trademark Holdings, LLC and are used under license. All other trademarks are the property of their respective owners. © 2024 Motorola Solutions, Inc. All Rights Reserved.