



MOTOROLA

MTH800L

TETRA Handportable Terminal

Basic User Guide



When printed by Motorola

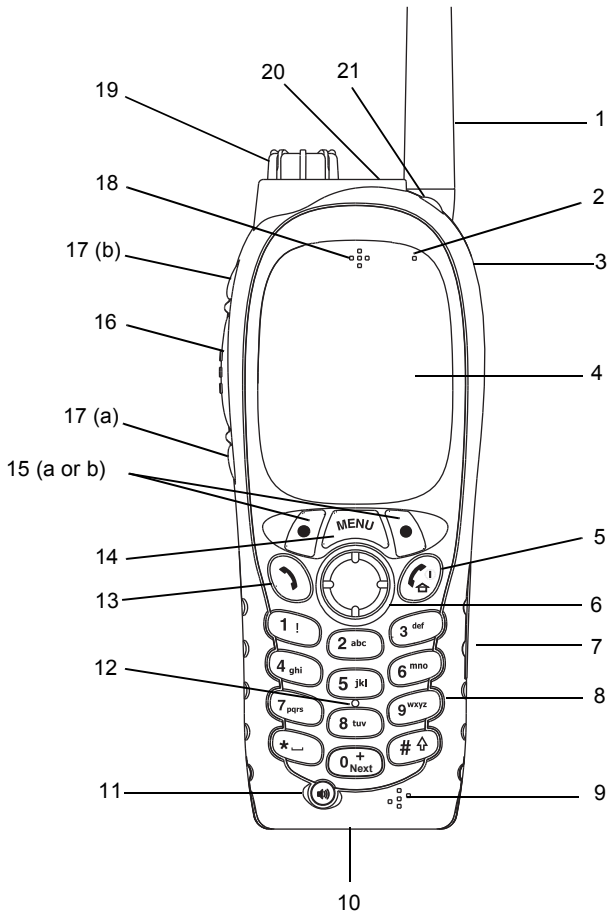

Contents

Safety Information	4
Disposal Information	4
Copyright Information	4
Icon Conventions	5
MTH800L Overview	6
Controls and Indicators	6
Audio Signal Tones	8
Periodic Alert	10
Key, Knob, and Button Overview	11
On-Off/End/Home Key	11
Soft Keys	11
Menu Key	11
Rotary Knob	11
Emergency Button	11
Function Keys	12
Speaker Control Key	13
Volume Adjustment Mode	13
The LED Status Indicator	14
To Enter the Menu Items	14
To Return to the Previous Level	14
To Exit the Menu Items	14
List of Menu Items	15
The Display	19
Status Icons	19
Menu Icons	22
Inbox Icons	23
Contact Icons	23
Outbox Icons	24
Text Entry Icons	24

Getting Started	27
Battery	27
Installing the Battery	27
Replacing the Battery	27
Charging the Battery	28
Battery Capacity Information	28
Attaching the Antenna	29
Powering On/Off (On-Off/End/Home Key)	29
Powering On (Emergency Button)	29
Powering On with Transmit Inhibit (TXI) Active	29
Unlocking the MTH800L	30
Locking/Unlocking the Keypad	30
Radio User Identity (RUI)	31
Selecting TMO or DMO Operation	32
Entering TMO or DMO	32
Group Calls	33
Favorite Folders	33
Selecting the “My Groups” Folder	33
Adding a Group (TMO/DMO)	33
Deleting a Group (TMO/DMO)	33
Renaming Favorite Folder	34
Deleting Favorite Folder	34
Selecting a Group	34
Using the Rotary Knob	34
Using the Navigation Key	34
Using Alphabetic Search	34
Using Folder Search	35
Using the Numeric Keypad - Speed Dialing	35
Selecting a Folder	35
TMO Group Calls	36
Making a TMO Group Call	36
Receiving a TMO Group Call	36
Receiving a TMO Broadcast Call	36
PTT Double Push	36

DMO Group Calls	37
Making a DMO Group Call	37
Receiving a DMO Group Call	38
Exiting DMO	38
Private, Phone, and PABX Calls	39
Creating a Contact	39
How to Dial	39
Dialing a Number	39
Dialing via the Contact List	40
Speed Dial	40
Private Call	40
Making a Private Call	40
Receiving a Private Call	41
Phone and PABX Calls	41
Making a Phone or PABX Call	41
Emergency Mode	42
Entering or Exiting Emergency Mode	42
Sending an Emergency Alarm	42
Hot Microphone Feature	43
Making an Emergency Group Call	44
Silent Emergency Mode	44
Call-Out	44
Messages	46
Sending a Status Message	46
Sending a New Message	46
Sending a User-Defined Message	46
Sending a Predefined Message	46
Handling New Incoming Text Messages	46
Handling Unread (New) Messages	47
Tips & Tricks	48
Quick Reference Guide	49

© Motorola Inc., 2009

MOTOROLA and the stylized M Logo are registered in the U.S. Patent and Trademark Office. All other product or service names are the property of their respective owners.

Safety Information



CAUTION

Before using these products, read the operating instructions for safe usage contained in the Product Safety and RF Exposure booklet 6864117B25.

The MTH800L is restricted to occupational use only to satisfy ICNIRP RF energy exposure requirements. Before using the products, read the RF energy awareness information and operating instructions in the Product Safety and RF Exposure booklet (Motorola Publication part number 6864117B25) to ensure compliance with RF energy exposure limits.

Keep this **User Guide** and the **Product Safety and RF Exposure booklet** in a safe place and make it available to other operators in case the accessories are passed on to other people.

Disposal Information



The **European Union Waste of Electrical and Electronic Equipment** directive requires that products sold into EU countries must have the crossed out trashbin label on the product (or the package in some cases). As defined by the WEEE directive, this cross-out trashbin label means that customers and end-users in EU countries should not dispose of electronic and electrical equipment or accessories in household waste.

Customers or end-users in EU countries should contact their local equipment supplier representative or service centre for information about the waste collection system in their country.

Copyright Information

The Motorola products described in this manual may include copyrighted Motorola computer programs stored in semiconductor memories or other mediums. Laws in the United States and other countries preserve for Motorola certain exclusive rights for copyrighted computer programs, but not limited to, including the exclusive right to copy or reproduce in any form the copyrighted computer program.

Accordingly, any copyrighted Motorola computer programs contained in the Motorola products described in this manual may not be copied, reproduced, modified, reverse-engineered, or distributed in any manner without the express written permission of Motorola. Furthermore, the purchase of Motorola products shall not be deemed to grant either directly or by implication, estoppel, or otherwise, any licence under the copyrights, patents, or patent applications of Motorola, except for the normal non-exclusive licence to use that arises by operation of the law in the sale of a product.

This document is copyright protected. Duplications for the purpose of the use of Motorola products are permitted to an appropriate extent. Duplications for other purposes, changes, additions or other processing of this document are not permitted. Only this electronically-saved document is considered to be the original. Duplications are considered merely copies. Motorola, Inc., and its subsidiaries and affiliates do not vouch for the correctness of such kinds of copies.

Icon Conventions

The document set is designed to give the reader more visual cues. The following graphic icons are used throughout the documentation set. These icons and their associated meanings are described below.



WARNING

The signal word Warning with the associated safety icon implies information that, if disregarded, could result in death or serious injury, or serious product damage.



CAUTION

The signal word Caution with the associated safety icon implies information that, if disregarded, may result in minor or moderate injury, or serious product damage.

CAUTION

The signal word Caution may be used without the safety icon to state potential damage or injury that is not related to the product.

NOTE

Notes contain information more important than the surrounding text, such as exceptions or preconditions. They also refer the reader elsewhere for additional information, remind the reader how to complete an action (when it's not part of the current procedure, for instance), or tell the reader where something is located on the screen. There is no warning level associated with a Note.

MTH800L Overview

Controls and Indicators

The numbers below refer to the illustration on the inside front cover.

Number	Description
1	Antenna
2	Top Microphone Activated during Simplex, high-audio calls such as Group Calls.
3	External Antenna Connector Used with the digital car kit to connect the RF signal to the external antenna. (At the back of the MTH800L)
4	Color Display Provides alphanumeric text and images within 65,536 colors and 130 x 130 pixels with backlight, scalable fonts, and contrast.
5	On-Off/End/Home Key <ul style="list-style-type: none">• Press and hold to turn the MTH800L On/Off.• Press to end calls.• Press to return to the Home display (idle screen).
6	Four Way Navigation Key Press up, down, left or right for list scrolling, while moving around the menu hierarchy, or for alphanumeric text editing.
7	Audio Accessory Connector (At the side of the MTH800L)
8	Alphanumeric Keypad Use the keypad to enter alphanumeric characters for dialing, contact entries and text messages.
9	Bottom Microphone Activated during Simplex and Duplex, low-audio calls such as Phone Calls.
10	Accessory Connector Provides connection for accessories. (At the base of the MTH800L)
11	Speaker Control Key Selects earpiece (low audio), PHF (low audio) or speaker (high audio).

Number	Description
12	Speaker (under keypad)
13	Send Key Used to initiate or answer Duplex calls (such as Phone Calls), or send status and text messages.
14	Menu Key Used to enter the main menu and the context sensitive menu.
15	Soft Key(s) Press to select the option that appears in the display directly above the left or right soft key.
16	Push-To-Talk Button (PTT) Press and hold this side button to talk in Simplex calls, release it to listen. Press to send status and text messages.
17	Programmable Side Keys 1 and 2 Default programming: upper Side key activates/deactivates Backlight; lower Side key activates Screen Saver. (See also No. 19)
18	Earpiece
19	Programmable Rotary Knob Default programming: "Dual" – Press the knob to toggle between "volume" and "list". Side keys (No. 17) operate as programmed.
20	Emergency Button (on top of the MTH800L). Press and hold to enter Emergency Mode, and send Emergency Alarms (as programmed). When the MTH800L is Off, press and hold to power on in Emergency Mode or in normal mode (as programmed).
21	LED (Indicator)













NOTE *Before using your MTH800L for the first time, remove the plastic lens protector from the display, and charge the battery overnight to ensure battery is initialised to its full capacity.*











NOTE *Take care to clean the bottom connector frequently and particularly prior to the programming procedure e.g. with a soft brush (do not use fluids).*

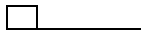

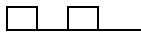
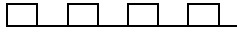

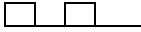

NOTE *It is recommended to turn off the terminal before connecting any of the accessories.*

Audio Signal Tones

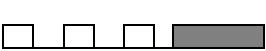
□ = High Tone; ■ = Low Tone;

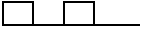
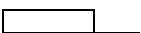
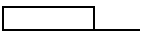
Description	Type	Repeated
Idle		
<ul style="list-style-type: none"> • Back to Home display • Back to rotary volume use when rotary scroll timer expires • Back to coverage • Back to full service 		Once
Clear-to-send		Once
Bad key press		Once
<ul style="list-style-type: none"> • Good key press • MTH800L self-test fails at power up • From out-of-service to in-service 		Once
In Call		
Call clear warning		Once
Call waiting tone while Phone or Private Call are pending.		Every 6 seconds, until a call is terminated
Data connected or Data disconnected		Once
Talk Permit sounds upon pressing the PTT.		Once (Normal Tone)
		Once (Short Tone)
Talk permit without gateway sounds upon pressing PTT. The tone indicates the gateway is no longer available.		Twice
		Once
<ul style="list-style-type: none"> • Talk prohibit • System busy • Time-out timer expire • Called MTH800L not available or busy 		Until you release the PTT.

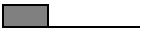
Description	Type	Repeated
Call disconnected or failed due to network		Once
Wrong number dialed		No tone
DMO (Direct Mode) Entering		Once
DMO Exiting		Once
Local site trunking – Entering/Exiting		Once
Phone ring back (sending)		Every three seconds, until the called user answers or call is rejected
Phone busy		Every 0.5 seconds
Status message sent to the dispatcher or failed		Twice
Incoming Calls		
Status message acknowledged by the dispatcher		Four times
Your MTH800L received a Group Call without gateway (setup only)		Once
High-priority Group Call received		Once
Emergency Alarm sent or received		Twice
Emergency Alarm failed		Four times
Emergency Call received		Once
Phone ring, Duplex Private Call (reception)	According to the Ring Style sub-menu setting.	Until you answer or the call is rejected
Private Call received	According to the Ring Style sub-menu setting.	Until you answer or the call is rejected
Private Call ringing to the caller		Until the call is answered

Description	Type	Repeated
Simplex Private Pre-emptive Priority Call (PPC) ring		Every 4 seconds, until the call is answered or rejected
Duplex Private PPC ring		Every 4 seconds, until the call is answered or rejected
Limited service		Once, upon entering limited service
New mail received		Once
New Group Call		Once
General		
Volume setting (earpiece, keypad, speaker)		Continuous
Volume setting (ringer)		While setting the volume
Transmit Inhibit (TXI)		Once
Double PTT - Single Tone		Once
Double PTT - Double Tone		Once
Double PTT - Triple Tone		Once

NOTE *Call-Out tones cannot be muted by the user.*

Periodic Alert

Periodic alert indicates the missed calls and the unread messages. For each indication the unread message tone is played with the orange LED color.



This feature can be disabled/enabled by the user. Press  and select **Setup > Tones > Periodic Alert** also to set the period of time between the indications.

Key, Knob, and Button Overview

On-Off/End/Home Key

- Press and hold to turn the MTH800L On/Off.
- Press to end calls.
- Press to return to the Home display.

Soft Keys

Press  or  to select the option that appears in the display directly above the left or right soft key.

Menu Key

Menu key has two functions. Press  to enter:

- **The menu** (when not in the menu). The MTH800L menus allow you to control your MTH800L settings.
- **Context sensitive menu** (when  icon is on and while not on Idle screen) to view a list of items for the current menu.

Rotary Knob

The Service Provider can program the Rotary knob to one of the following uses:

1. **Dual control** – the knob is used as both a volume control and to scroll through lists. Press the knob to toggle between volume and list control (default programming).
2. **List control** – the knob is used to scroll lists (e.g. Talkgroup lists) or menu items. In this case volume control is always via the Side keys.
3. **Volume control** – the knob is used only as a volume control; turn clockwise to increase the audio volume level.



Press and hold the Rotary knob to lock it, press and hold it again to unlock. Powering Off also unlocks a locked Rotary knob.



Emergency Button

Press and hold this button to enter Emergency Mode.

When the MTH800L is powered down, press and hold this button to power On in Emergency Mode or in standard mode (as programmed).

Function Keys

NOTE For information on the function assigned to each Side, Numeric,  or  keys, please refer to your Service Provider.

NOTE The required time you need to press the Side, Numeric,  or  keys to activate a one-touch function is set as default to 1 second. This time may be set, however, by your Service Provider.

Side Keys

The Rotary knob and Side key programming are paired:

Rotary Knob Programming	Side Key Programming
Dual control	Programmed to a one-touch function
List control	△: Volume Up ▽: Volume Down
Volume control	Programmed to a one-touch function

When the Rotary knob is programmed to volume control or dual control, the Side keys support the one-touch feature that allows you to select or activate commonly used features by pressing and holding a single key. By default, the upper Side key is set to “Backlight On/Off” and the lower Side key is set to “Screen Saver On”. Please check with your Service Provider.

Numeric, and Keys

The MTH800L supports the one-touch feature that allows you to select or activate commonly used features by pressing and holding an assigned key.

One Touch Private Call

The MTH800L supports the one-touch private call if it is set by the Service Provider. User can dial the last group call originator number via pressing the assigned button.

Speaker Control Key

Press  to activate the earpiece (low audio), PHF (low audio) or speaker (high audio), depending on the menu settings.

Type of Call	Menu Setting	Key Use
Simplex call (Group*/Private)	Menu > Setup > Audio > Audio Toggle > Spkr Cntrl	Speaker On/Off for Group and Private Calls
	Menu > Setup > Audio > Audio Toggle > Always Loud	Speaker On/Off for Private Call
Duplex call (Private/Phone/ PABX)	-----	Controls speaker/earpiece of the on-going call

* In an Emergency Group Call, the voice sounds from the speaker regardless of the speaker setting.

Volume Adjustment Mode

The Service Provider can enable Volume Adjustment Mode feature. All the settings regarding **Individual** mode are adjustable and retained even if the user switches back to **Common** mode.

In **Common** mode the user adjusts all the **Volumes** at the same time.



To change the volume setting or settings, press  > **Setup** > **Set Volume**.

The LED Status Indicator

The LED indicator shows the states of your MTH800L.

Indicator	Status
Solid green	In use
Flashing green	In service
Solid red	Out of service
Flashing red	Connecting to a network/Entering DMO
Solid orange	Transmit Inhibit (TXI) in service / Channel busy in DMO
First solid then flashing orange	Incoming call
No indication	Switched off

To Enter the Menu Items

1. Press .
2. Scroll to the required item, press **Select** or  to select.

To Return to the Previous Level

Press **Back** or .

To Exit the Menu Items

Press .

NOTE *Your MTH800L may exit if no key press is detected for a time-out period.*

List of Meun Items

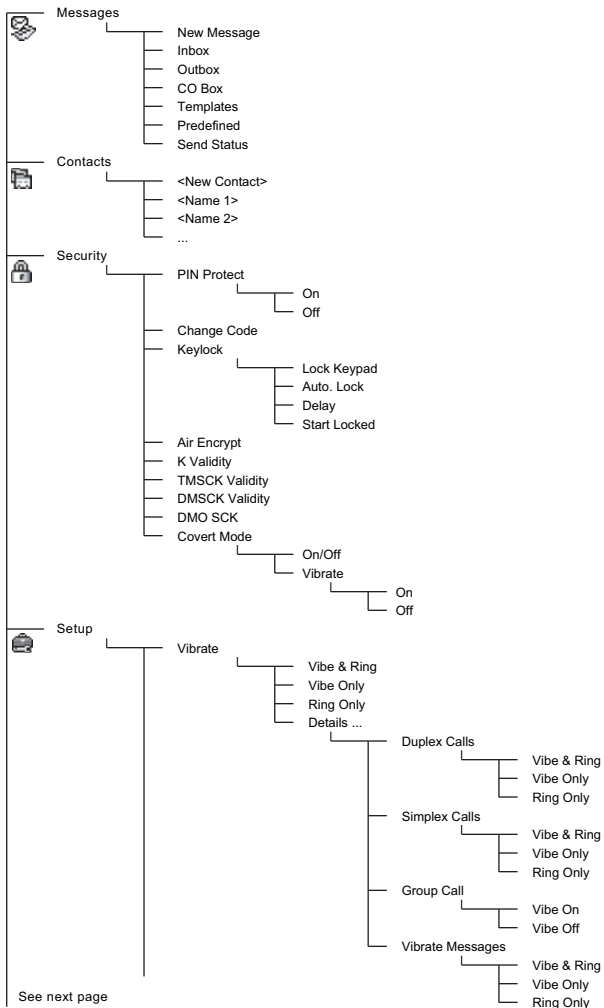

See next page

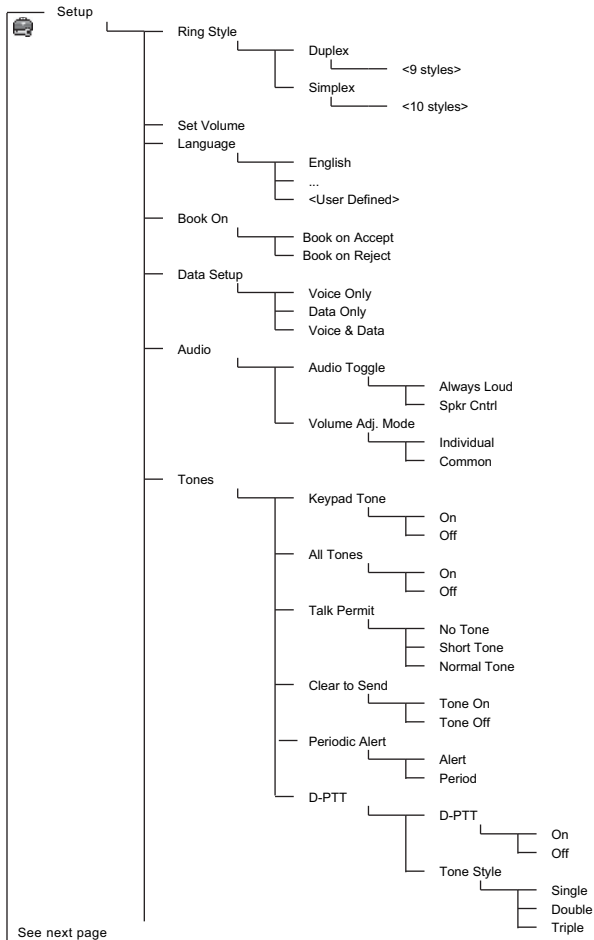

See next page

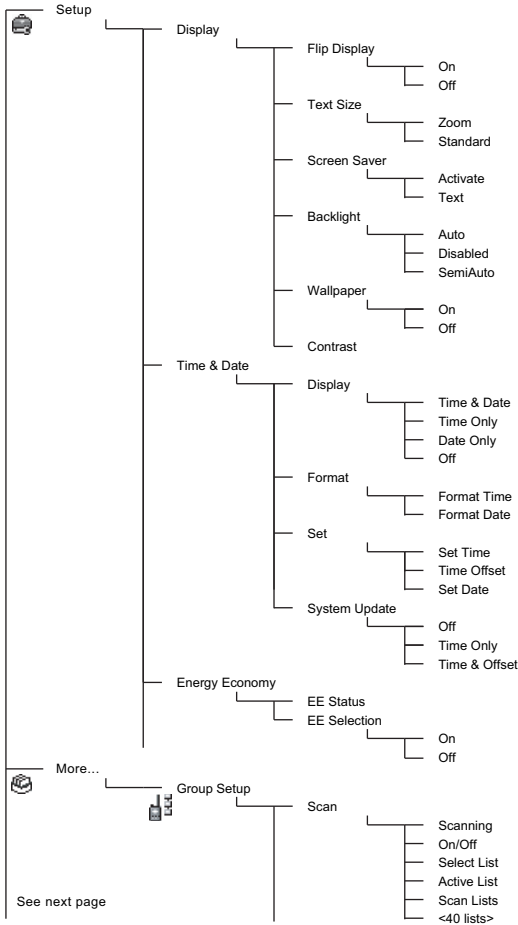

See next page

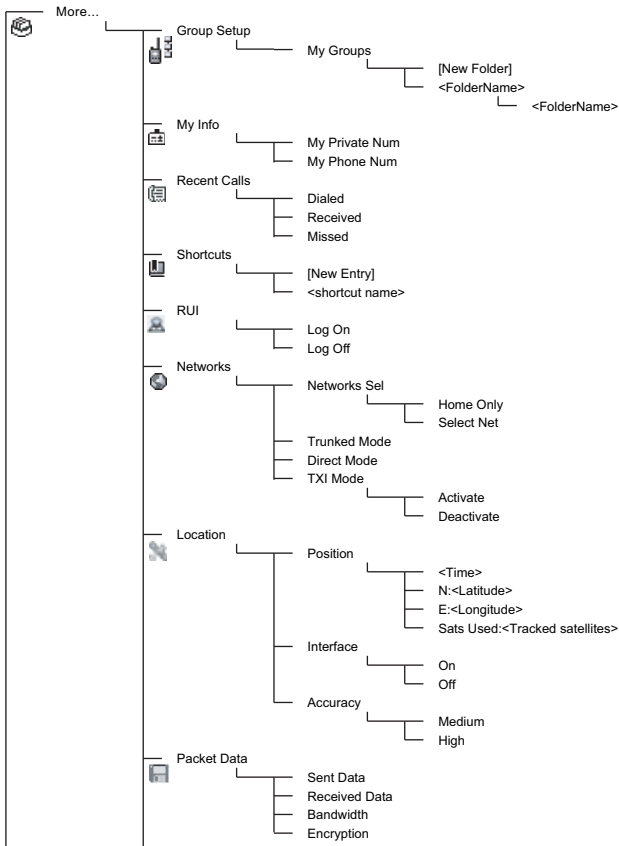

NOTE *This is the standard menu layout. Your Service Provider may enable/disable some menu items or change their names.*

Creating Menu Shortcuts

Use shortcuts to access frequently-used menu items.

Menu Shortcut Creation

Navigate to the menu item and press and hold  as the item is highlighted.

Menu Shortcut List

To look for assigned shortcuts, press  and select **More... > Shortcuts > <shortcut name>**.

Menu Shortcut Use





From Home display, press  and the numeric key(s) assigned to the shortcut.









The Display











When you use your MTH800L, icons appear on the display to indicate the following conditions.

Status Icons

Status icons appear when your phone is engaged in certain activities or when you have activated certain features.









Status Icon	Description
Trunked Mode Operation (TMO)	
	Signal Strength Allows you to check signal strength. More bars indicate a stronger signal.
	No Service
	Scan Indicates scanning is activated in the MTH800L.
	Data Connected Displayed when the MTH800L is successfully connected to an external device and ready for data transfer.
	Data Transmit/Receive Displayed when the MTH800L is transferring data to/receiving data from the external device (laptop or desktop PC). No number – standby data session. Number 1, 2, 3, or 4 – indicates active data session with 25%, 50%, 75%, or 100% bandwidth.

Status Icon	Description
Direct Mode Operation (DMO)	
	Signal Strength Indicates an incoming Direct Mode Group Call.
	Direct Mode Displayed when the MTH800L is in Direct Mode.
	DMO Gateway Indicates that gateway is selected. The icon has three states: Solid – while the MTH800L is synchronised with the gateway. Flashing – while the MTH800L is not synchronised or during attachment. No icon – during a terminal to terminal and repeater call.
	DMO Repeater Displayed when the repeater option in DMO is selected. This icon has three states: Solid – while the terminal has detected the repeater (i.e., when the terminal receives a presence signal). Blinking – while the terminal has not detected the repeater or during attachment. No icon – during a terminal to terminal and gateway call.
General Icons	
	All Tones Off / Duplex & Simplex Ring Muted Indicates that all alert tones are off in the MTH800L or both Simplex Ring volume is set to 0 and Duplex Ring volume is set to 0.
	Simplex Ring Muted Indicates that Simplex Ring volume is set to 0 and Duplex Ring volume is set to more than 0.
	Duplex Ring Muted Indicates that Duplex Ring volume is set to 0 and Simplex Ring volume is set to more than 0.
	Vibrate On Indicates that the MTH800L will vibrate to alert you of an incoming call.
	Vibrate and Ring Indicates that the MTH800L will vibrate and ring to alert you of an incoming call.

Status Icon	Description
	Speaker Off (Low Audio) Indicates that the audio will sound through the earpiece. (See detailed explanation of Speaker Control key.)
	Low Audio Indicates that the audio mode is changed to low.
	High Audio Indicates that the audio mode is changed to high.
	Earpiece Connected Indicates that the earpiece is connected.
	RUI Pseudo Log On Indicates that the user is pseudo logged on.
	Pseudo Log On with Packet data Indicates that the user is pseudo logged on and Packet Data at the same time.
	Battery Strength Shows the charge in your battery. Full icon is full charge.
	Emergency Appears while the MTH800L is in Emergency Mode.
	List Scrolling Displayed to indicate that the Rotary knob use is list scrolling, as long as this use is selected.
	New Message Has Arrived Indicates a new message just arrived.
	New Message(s) in Inbox Indicates that you have unread messages in your inbox.





Menu Icons

The following icons make it easy to identify the menu items at first glance.

Menu Icon	Description
	Main Menu Items/Context Sensitive Menu Appears above  if the main menu items/context sensitive menu are active.
	Messages <ul style="list-style-type: none">• Send status messages,• Send text messages (free text or according to user defined or predefined templates),• Receive messages in inbox.
	Contacts Add, search, edit, or erase entries in the contact list.
	Security Lets you turn On/Off and verify security features, and change passwords.
	Setup Allows you to customise your MTH800L.
	More... Contains more customisable menu items.
	Scroll Bar Indicates navigation among items that occupy more than one screen. If all items appear in one screen, the scroll bar is empty.







Inbox Icons

The following icons indicate the status of messages in the inbox.

Inbox Icon	Description
	Unread (New) Message Indicates that you have not read the message yet.
	Read (Old) Message Indicates that you have read the message.
	Sender Information in Message View Indicates sender information (name or number).
	Time and Date Stamp in Message View Indicates the time and date of message arrival.
	Delivery Status Received Indicates delivery status for Store & Forward messages.



Contact Icons

In the contact list display, the following icons may appear next to the contact numbers to indicate the type of stored number.

Contact Icon	Description
	Private ID Number
	Mobile Phone Number
	Home Phone Number
	Work Phone Number
	PABX Number
	Other Phone Number
	Pickers Indicate more than one number is stored with the contact.

Outbox Icons

In the Outbox submenu those three icons indicate the process of sending the Store & Forward messages. For more information please contact your Service Provider.

Outbox Icon	Description
	Delivery in Progress
	Delivery Accomplished
	Delivery Failed

Text Entry Icons

Selecting the Text Entry Mode

Text entry modes make it easy for you to enter names, numbers, and messages.

In the text entry screen, press  > **Entry Mode**, and then select one of the following modes:

- **Primary** – for entering alphanumeric characters
- **Numeric** – for entering numbers only
- **Symbol** – for entering symbols only
- **Secondary** – for entering alphanumeric characters. (This mode is optional and you have to add it to the list.)

In the text entry screen, you can also press  repeatedly to change to Primary, Numeric, Symbol, or Secondary (if you have set it up).

Adding Secondary to the List of Text Entry Modes

Secondary is convenient when you use one language, and sometimes wish to switch to another one.

This mode appears in the list only if you set it up first via

 > **Entry Setup**.

None is the default programming from factory and indicates no secondary entry mode is selected.

Selecting the Text Entry Method and Language

There are two text entry methods:

- **TAP** – Enter letters, numbers and symbols by pressing an Alphanumeric key one or more times.
- **iTAP** – Let the terminal predict each word as you press an Alphanumeric key.

You can use these methods in the languages programmed in the terminal.







In the text entry screen, press  > **Entry Setup**, and then change to one of the methods and its related language (for example: TAP English).

Text Capitalisation

Press .

Icons











In the text entry screen, icons tell you which text entry mode and method you are using. A character counter icon indicates the number of entered characters.

Primary Icons	Secondary Icons	Description
abc 1	abc 2	TAP – no capitals
Abc 1↑	Abc 2↑	TAP – capitalise next letter only
ABC 1↑	ABC 2↑	TAP – all capitals
abc 	abc 	iTAP – no capitals
Abc 	Abc 	iTAP – capitalise next letter only
ABC 	ABC 	iTAP – all capitals



Numeric Icon	Description
123	Enter numbers.

Symbolic Icon	Description
@	Enter punctuation and symbols.

List of Keys and Characters in Alphanumeric Mode (TAP/iTAP)

Key	Alphanumeric Mode (TAP/iTAP)
	Press to cycle through single shift, caps lock, and lower case.
	.,?!01@'"/:~;+&%*^=<>€£\$¥¤□[]{} \~^`¡; \$ #
	A B C 2 a b c 2
	D E F 3 d e f 3
	G H I 4 g h i 4
	J K L 5 j k l 5
	M N O 6 m n o 6
	P Q R S 7 p q r s 7
	T U V 8 t u v 8
	W X Y Z 9 w x y z 9

List of Keys and Characters in Numeric Mode

Key	Numeric Mode
 to 	<ul style="list-style-type: none"> • Press to enter digit at insertion point. • Press and hold any numeric key to enter TAP alphanumeric mode. • To exit TAP alphanumeric mode, press and hold any numeric key.

Getting Started

Battery

Installing the Battery

1. Remove the battery from its protective clear plastic case.
2. If necessary, remove the battery cover as shown below.
3. Insert the battery top into the compartment as illustrated.
4. Carefully press the battery silver bottom downward until it clicks into place.
5. Replace battery cover.

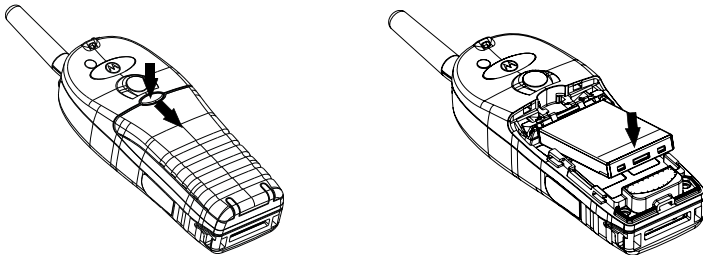

Replacing the Battery

1. To remove the battery cover, push down the cover button. Slide the cover away.
2. Push retaining clip up and then lift the top of the battery out.
3. Replace the battery.

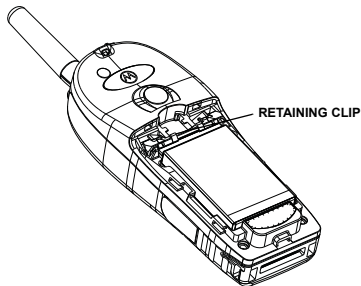

Charging the Battery

Motorola approved chargers provide optimum performance. Other chargers may not fully charge your Motorola Lithium-Ion battery or may reduce the life of the battery.

The MTH800L can be either **On** or **Off** during charging.

1. Insert the connector on the charger into the socket at the base of the MTH800L. Select the required plug adapter (UK or European type) and connect to the charger. Then plug the charger into a suitable mains socket.
2. The MTH800L displays the **Charger Connected** message only if the MTH800L is **On** when connecting the charger. If the MTH800L is **Off**, the display shows an icon of the battery in charging.

The Battery icon shows the charging status (see below).



Empty



Full



Empty



Full

Battery Capacity

Battery Charge Progress

Battery Capacity Information

Information	Description
Green icon	Full (50% –100% capacity)
Yellow icon	Middle (20% –50% capacity)
Red icon	Low (10% – 20% capacity)
Empty icon	Very low (5% –10% capacity)
Low battery message	Less than 5% capacity

Attaching the Antenna

NOTE Turn the MTH800L Off before installing or removing the antenna.

Insert the bottom of the antenna into the screw-in base on the top of the MTH800L. Turn clockwise until snug. **Do not force.**

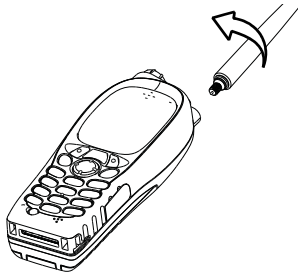

Powering On/Off (On-Off/End/Home Key)

To power **On**, press and hold . Your MTH800L performs a self-check and registration routine. After successful registration, the MTH800L is in service.

To power **Off**, press and hold . You will hear a beep and the **Powering Off** message is displayed.

Powering On (Emergency Button)

Press and hold the Emergency button to power **On**. The MTH800L will power **On** in Emergency Mode or in standard mode (as programmed).

Powering On with Transmit Inhibit (TXI) Active

Transmit Inhibit is a feature allowing you to switch off transmission before entering a Radio Frequency (RF) sensitive area. To activate this feature, press  and select **More... > Networks > TXI Mode > Activate**.



WARNING

*Pressing the Emergency button, even if Transmit Inhibit is activated, causes the MTH800L to transmit immediately. The MTH800L must **NOT** be within the RF sensitive area when entering Emergency Mode.*

The TXI Mode remains active at power **On**. You will be asked whether to leave the TXI Mode **On** or not.



WARNING

Ensure you have left the RF sensitive area before deactivating Transmit Inhibit.

Press the **Yes** soft key to deactivate the TXI Mode. If the MTH800L was previously used in Trunked Mode, it will register to the network. If the MTH800L was previously used in Direct Mode, it will remain in Direct Mode.

Press **No** in Trunked Mode and the MTH800L powers down; press **No** in Direct Mode and you remain in Direct Mode with TXI selected.

Unlocking the MTH800L





Your MTH800L may be locked at power up.

To unlock the MTH800L after powering on, enter the code at the prompt. The MTH800L enters the default Home display.

The unlock code is originally set to 0000. Your Service Provider may change this number before you receive your terminal.

Locking/Unlocking the Keypad

To prevent accidental key/button presses:

Press   to lock the keypad. Press again   to unlock. Service Provider can choose the notification for the Keypad lock and if to lock the **PTT**.

Keypad Lock Notification

When the keypad is locked one of the following instructions is displayed:

- None – no notification is display.
- Notification Only – **Keys Locked** is displayed.

Notification and Instruction – **Keys Locked, Press Menu and * to lock/unlock** is displayed.



Automatic Keylock

This feature locks the keypad automatically after not using it for a predefined time. To turn it on/off or to set the delay go to **Menu > Security > Keylock Setup**.

Keypad Lock on Startup

The user can set the Keylock at the start up of the terminal. To turn it on / off go to **Menu > Security > Keylock > Start Locked**.

NOTE

Your Service Provider can lock the keypad with and without the PTT,  and  during incoming call, but the Rotary knob and  are always available.

NOTE

The Emergency button is not locked. Pressing the Emergency button unlocks the keypad.

Radio User Identity (RUI)

Your MTH800L needs to confirm RUI to provide the full service. After powering on you are prompted to input your **User ID** and **User PIN**.

To **Log on** press  > **More... > RUI > Log on**

To **Log off** press  > **More... > RUI > Log off**

If the Log on is not successful radio has limited access which is specified by the Service Provider.

NOTE

Radio with RUI feature disabled provides the full service to the user without login prompt.



NOTE

All the time the display indicates if the user is logged on (blue color of the icon) or logged off (grey color of the icon).

Selecting TMO or DMO Operation

Entering TMO or DMO

Enter TMO or DMO in one of the following ways:

- From the Home display press **Optns** and select **Direct Mode** if the MTH800L is in TMO.
- From the Home display press **Optns** and select **Trunked Mode** if the MTH800L is in DMO.
- Press  and select **More... > Networks > Trunked Mode** if the MTH800L is in DMO.
- Press  and select **More... > Networks > Direct Mode** if the MTH800L is in TMO.
- Press the TMO/DMO one-touch button (if programmed by your Service Provider).

You can make and receive the following types of calls when the MTH800L operates in Trunked Mode:

- Group Calls
- Private Calls
- Private Calls via MS-ISDN
- Phone Calls
- PABX Calls – local (office) extension calls
- Emergency Calls
- Emergency Private Calls.

You can make and receive Group and Private Calls when the MTH800L operates in Direct Mode. This includes Emergency Group Calls.

The MTH800L returns to the Home display when there is no activity for a few seconds.

NOTE

Your terminal can alert you of an incoming call. Select the alert settings in the Vibrate menu and Tones menu items.

Group Calls

A Group Call is a communication between you and others in a group. A group is a pre-defined set of subscribers enabled to participate in and/or invoke a Group Call.

Groups are organized in maximum three folders. Each folder may contain folders and several groups.

Favorite Folders

You can organise your favorite groups into three folders.

Selecting the “My Groups” Folder

NOTE *Default name for the first favorite folder is “My Groups”.*

From the Home display, press  to quickly access the folders.

Adding a Group (TMO/DMO)

1. Press  and select **More... > Group Setup > My Groups > <FolderName> > [New Group]**.
2. Select a group by alphabetic search (“**TMO/DMO by abc**”). Enter up to 12 characters of the group name. Or select a group by folder search (“**TMO/DMO by Folder**”). Select the folder and select the group. The group is added to the “My Groups” folder.



Deleting a Group (TMO/DMO)

1. Press  and select **More... > Group Setup > My Groups > <FolderName>**.
2. Highlight talkgroup name that you want to delete and select **Delete**.



NOTE *To delete all the groups press  and select **Delete All**. This option is available only if the Service Provider enables it.*

3. Press **Yes** to confirm.

Renaming Favorite Folder

1. Press  and select **More... > Group Setup > My Groups**.
2. Highlight a group folder name and press .
3. Select **Rename Folder**.
4. After editing the name of the folder press **Ok** to confirm.

Deleting Favorite Folder

1. Press  and select **More... > Group Setup > My Groups**.
2. Highlight a group folder name and press .
3. Select **Delete Folder**.
4. Press **Yes** to confirm.

NOTE *You cannot delete the last favorite folder.*

Selecting a Group

NOTE *When you navigate in the Favorite folders and select a DMO group, your terminal will switch between TMO and DMO (and vice-versa).*

Using the Rotary Knob

(If programmed)

From the Home display, press shortly on the Rotary knob and rotate until the requested group appears.

Group selection occurs:

- After a time-out
- Or, by pressing **Select** (if configured by your Service Provider)

Using the Navigation Key

From the Home display, scroll left or right until the requested group appears. Then press **Select** to confirm selection.

Using Alphabetic Search

From the Home display, press **Optns**. Select a group by alphabetic search (“**TG by abc**”). Enter up to 12 characters of the group name.

Select the group.

NOTE *Even if the talkgroup exist in couple folders, alphabetic search displays it once.*

Using Folder Search

From the Home display, press **Optns**. Select a group by folder search (“**TG by Folder**”). Select the folder and select the group.

Using the Numeric Keypad - Speed Dialing

From the Home display, you can dial a group by entering its speed number via the keypad. This feature is called Talkgroup Speed Dialing. The speed number is pre-configured in the terminal.

You can view a speed number attributed to a group, if it exists.

Viewing the speed number

1. From the Home display, press **Optns**.
2. Select **TG by Folder** and then appropriate folder name.
3. Press .
4. Select **View** to view the talkgroup speed number.

In this example “82” is the speed number. Press **Back** to return to the attached group screen.

Using a speed number

1. Enter a number (for example: “82”).
2. Press .
3. Press **Attach** to attach the new group, or press **PTT** to attach and call.

NOTE

Speed Number for the TMO and DMO groups can be the same. For example if you are in TMO mode all the speed numbers from this mode are going to work.

Selecting a Folder

From the Home display, press **Optns**. Select **Folder**, and select the desired folder. The display shows the last selected group in that folder.

TMO Group Calls

In TMO the MTH800L is used with your Service Provider's infrastructure.

Making a TMO Group Call

1. From the Home display and if this is the required group, press and hold the **PTT**.
2. Wait for the talk permit tone and then speak into the microphone. Release the **PTT** button to listen.

When you start a call, all members of the selected group who have their units turned on, will receive the Group Call.

NOTE *If you are in an on-going Group Call and wish to make a new call, press  to ignore the current call. Start the new call.*

NOTE *The **No Group** message is displayed when you are out of the normal coverage area of your selected group. You must then select a new group that is valid for your working location.*

Receiving a TMO Group Call

Unless it is engaged in a call, your MTH800L will receive the Group Call. To answer the call, press and hold **PTT**.

Your MTH800L shows the group name and the caller's private number or alias if previously stored in your contact list.

Receiving a TMO Broadcast Call

The Broadcast Call (also called Site Wide Call) is a high-priority Group Call from the console operator (or dispatcher) to all users. The MTH800Ls are configured to monitor a Broadcast Call, but users cannot talk back.

The Broadcast Call pre-empts an on-going Group Call that has the same (or lower) call priority.

PTT Double Push

This feature, if enabled by your Service Provider, allows you to send the tone when the radio is in idle or Group Call mode by pressing **PTT** twice.

NOTE *This feature interacts as the **PTT** pressed to invoke the Group Call.*

After the D-PTT tone is played, the user can press and hold the PTT once again to get the permission to talk. To activate/deactivate the D-PTT Tone:

1. From the main menu, select **Setup > Tones > D-PTT Tones > D-PTT Mode**.

2. Choose required setting, and press **Select**. Press **Back** to exit.

To choose the tone:

1. From the main menu, select **Setup > Tones > D-PTT Tones > Tone Style**.

2. Choose the tone between three options: **Single**, **Double** or **Triple**. Please go to D-PTT Tones on page 10 to view the specification of the tones.

DMO Group Calls

In DMO the MTH800L can be used without your Service Provider's infrastructure.

DMO allows communication with other terminals also operating in DMO, which are on the same frequency and group as your MTH800L.

NOTE *In DMO it is only possible to place the following call types: Group Calls, Emergency Group Calls, Private and Private Simplex Calls.*

When you start a call, the members of the selected group who have their units turned on will receive the Group Call.

In DMO the MTH800L can communicate with the trunking system (and vice-versa) if the Gateway option is enabled in the MTH800L.

Making a DMO Group Call

1. Enter **Direct Mode** by pressing **Optns** and selecting **Direct Mode**.

2. Make sure that you have selected the required group. Press and hold the **PTT** button.

3. Wait for the talk permit tone and then speak into the microphone. Release the **PTT** button to listen.

Receiving a DMO Group Call

You can receive a DMO Group Call only when your MTH800L is in DMO.

Unless it is engaged in a call, your MTH800L will receive the Group Call. To answer the call, press and hold **PTT**.

Your MTH800L shows the group name and the caller's private number or alias if previously stored in your contact list.





Exiting DMO

To exit DMO, press **Optns** and select **Trunked Mode**.

Private, Phone, and PABX Calls

NOTE *If you are in an on-going Group Call wish to make a new call, press  to ignore the current call. Dial the number.*

Creating a Contact





1. From the Home display, press **Contcs**. Select [New Contact].
2. Enter name. Press **Ok** to confirm.
3. Press  /  and select the type of stored number (such as Private).
OR
 - Press **Change**, the display shows 6 type selections.
 - Press  /  to choose a type of stored number.
 - Press **Select**, the display returns to Contact Details screen.
4. Enter number (#). Press **Ok**.
5. Continue to enter other types and numbers, as you may keep several numbers (Private, Mobile, Home, Work, PABX, Other) for the same person under the same contact name.
6. When finished, press **Done**. Press **Back** to return to Home display.

How to Dial

Dialing a Number



1. From the Home display dial a number.
2. Press **CType** repeatedly to select the call type (Private, Phone, or PABX).
3. Press **PTT** or  depending on the call type.

Dialing via the Contact List

You can also use the contact list to select a number you previously stored. Press **Contcs** and search the stored number by scrolling ( or ) or by entering up to 12 characters of the contact name using alphabetic search. If the contact has more than one number, use  /  to select the number.

Speed Dial

Speed dial allows you to dial a shortened number of up to three digits instead of the full number. The speed dial number is the location of an entry in the contact list.

1. Enter the pre-programmed speed dial number (for example: 5) and press .
2. To place the call, press .

To hang up, press .

Private Call

A Private Call, also called Point-to-Point or individual call, is a call between two individuals. No other terminal can hear the conversation. This call can be:

- a Duplex call (if the system allows) in TMO, or
- a standard Simplex call in TMO or DMO.

Making a Private Call



1. From the Home display dial a number.
2. If Private is not the first type of call presented, press **CType** to select the Private Call type.
3. For a *Simplex* call, press and release the **PTT** button. You will hear a ringing tone. Wait for the called person to answer your call. Press and hold **PTT**. Wait for the talk permit tone (if configured) before talking, and release the **PTT** when listening.

For a *Duplex* call, press and release . You will hear a ringing tone. Wait for the called person to answer your call.

4. To end the call, press . If the called person ends the call, the **Call Ended** message is displayed.

NOTE *While Transmit Inhibit is activated, an incoming Private Call is indicated, but you cannot answer the call.*

Receiving a Private Call

1. The MTH800L switches to the incoming Private Call. The display shows the caller's identity.
2. To answer an incoming *Simplex* call, press **PTT**. To answer an incoming *Duplex* call (indicated by **Spkr/Erpc** soft keys), press  or green receiver button.
3. To end the call, press .

NOTE *Your terminal can alert you of an incoming call. Select the alert settings in the Vibrate menu and Tones menu items*

Phone and PABX Calls

The **Phone Call** allows you to call a landline telephone number, a cellular mobile phone number or another terminal using ISDN number.

NOTE *Feature MS-ISDN enables the terminal to make and receive the calls from the phone using ISDN number.*

The **Private Automatic Branch Exchange (PABX) Call** allows you to call local (office) extension numbers. This type of call needs to be activated by your Service Provider.

In this publication we use "phone number" when referring to these numbers.

NOTE *While Transmit Inhibit is activated, an incoming Phone or PABX Call is indicated, but you cannot answer the call.*

Making a Phone or PABX Call

1. From the Home display dial a number.
2. If Phone or PABX are not the first type of call presented, press **CType** repeatedly to select the Phone or PABX call type.
3. Proceed as for making and receiving Duplex Private Calls. If the user presses the PTT button it initiates a Simplex Phone Call.

Emergency Mode

You can send and receive **Emergency Group Calls** in **Trunked Mode** or in **Direct Mode**. If your terminal is configured to operate through a gateway, Emergency calls can be placed through the gateway.

You can initiate an Emergency Group Call to and receive it from:

- selected group (TMO and DMO) (if tactical emergency)
- pre-defined group (if non-tactical emergency).

Contact your Service Provider to know which is the selected mode.

Your Service Provider will configure the Emergency Alarm and Hot Microphone features.

Emergency calls will be allocated emergency priority in the system.

Entering or Exiting Emergency Mode

To enter Emergency Mode, press **and hold** the Emergency button at the top of the MTH800L.

NOTE *The required time you need to press the Emergency button is set to default to 0.5 seconds. The time can be configured by your Service Provider.*

NOTE *Pressing the Emergency button activates one or more services. Contact your Service Provider for more information.*

To exit Emergency Mode, press and hold **Exit**. Your terminal will switch to the Home display.

Sending an Emergency Alarm

Your MTH800L will send an Emergency Alarm to the dispatcher (if configured by your Service Provider):

- Automatically, upon entering Emergency Mode.
- If you press the Emergency button again while the MTH800L is in Emergency Mode.

After sending the alarm, the display will show one of the following delivery reports:

- **Alarm Sent**
- **Alarm Failed**

In both cases, the display returns within a few seconds to the main screen of the Emergency Mode.

Due to no delivery confirmation in DMO, **Alarm Sent** information confirms only sending the alarm.



WARNING

*Pressing the Emergency button, even if Transmit Inhibit is activated, causes the MTH800L to transmit immediately. The MTH800L must **NOT** be within the RF sensitive area when entering Emergency Mode.*

NOTE

The Emergency Alarm is a special status message sent to the dispatcher monitoring the selected group. This can be used in dispatch systems to highlight emergency calls.

NOTE

Some systems do not support the Emergency Alarm feature when the user is in a "Local Area Service" area.

Hot Microphone Feature

If the Hot Microphone feature was programmed into your MTH800L by your Service Provider, you can make an Emergency Group Call and talk to the dispatcher (and members of your group) without the need to press and hold the **PTT**.

The microphone will stay open for a time period (programmed by your Service Provider). The microphone will stay open until:

- the Hot microphone time period expires
- you press **PTT** during the Hot Microphone period
- you press the **End** key

At the end of the Hot Microphone the **Emgcy Mic Ended** message will be displayed and the MTH800L returns to the Emergency Mode. The Hot Microphone feature is disabled and PTT operation returns to normal.

If required you can resume Hot Microphone by pressing the Emergency button again. Also your Service Provider is able to resume Hot Mic without user interaction by setting Alternating Hot Mic feature.

NOTE

Hot Microphone feature is available in DMO and TMO mode.

Making an Emergency Group Call





- Hot Microphone enabled – to initiate an Emergency Group Call, press and hold **Emergency Button**.
- Hot Microphone disabled – to initiate an Emergency Group Call, press and hold **Emergency Button**. When the display has changed to Emergency Group Call hold **PTT** and wait for talk permit tone (if configured) and talk. Release the PTT to be able to listen.

Silent Emergency Mode

NOTE *Silent Emergency Mode needs to be enabled by the Service Provider.*

To enter Silent Emergency Mode, press **Emergency button**.

Silent Emergency Mode provides no audible and visible indication. All of the key tones are switched off.

To exit Silent Emergency Mode, press  and  key simultaneously or  and then  key within 3 seconds.

Call-Out

This feature allows the user to receive Call-Out alerts. When the Call-Out messages have been received by the radio, it interrupts current services and attends to the Call-Out alert without any further delay. After Call-Out alert has been cleared, the radio exits Call-Out mode and reverts back to normal mode. The user is able to receive only Emergency Calls during Call-Out mode. There are four types of the Call-Out alert:

- Normal Call-Out
- Storm plan – it is sent to a group several time to raise reliability. User can only accept the Call-Out by pressing any button and is moved to information phase (soft keys are not labelled).
- Fallback Mode – it includes only voice communication. It can be cleared manually



NOTE *Fallback is only possible when Radio is in Local Site Trunking.*

- Test Call-Out – dispatcher has the ability to test this feature. Radio is generating the tone with **Call-Out Test** on the display. Only one softkey is enabled **Test OK** to confirm and to clear the test.

Interactions when the user is in other mode

- TXI Mode – users can read the message but they can not respond to it. They have an option to leave the TXI Mode by pressing soft key or reject the Call-Out message.
- DMO Mode – Call-Out is not supported.
- Emergency Mode – all the Call-out alerts are ignored.

Call-Out service phases

- Alerting phase – user receives a Call-Out message. The alarm tone indicates that the message text is displayed. Under it there are three options for the user to pick: **Accept**, **Reject** or . If the user accepts the alert no other service from this point can interrupt.  key gives more choices.

NOTE *The user can stop the alert tone by pressing PTT or any of the soft keys.*

- Information phase – the user is still in the Call-Out mode and can receive more detail information about the incident that occurred via subsequent text or the voice message. The user can query for more information using voice group call or Call-Out text function which enables to send a text message to the Service Provider. User can always respond and send back the text or the voice message using voice group call.

Call-Out Box



Call-Out Box gives the user the option to view and store the Call-Out messages for future reference.

To view them press  > **Messages > CO Box**.



When the radio is in Call-Out Mode, you can only read the ongoing Call-Out messages.

Messages

Sending a Status Message



Select the desired group, then press  and select **Messages > Send Status**. Select status and press  or **PTT**.

Sending a New Message



Press  and select **Messages > New Message**. Write your message. Select **Send**, or press  or **PTT**. Select your mail recipient or enter number. Select **Send**, or press  or **PTT** to send the new message.

NOTE *The message can be send to private, phone and a group number. Phone option needs to be enabled by your Service Provider.*

Sending a User-Defined Message

Press  and select **Messages > Templates**. Scroll and choose your required template. Select **Send**, or press  or **PTT**. Select your mail recipient or enter number. Select **Send**, or press  or **PTT** to send the message.

Sending a Predefined Message

Press  and select **Messages > Predefined**. Scroll and choose your required template. Press  and select **Edit** to edit the message. Type required information. Select **Send**, or press  or **PTT** to send the message.

Handling New Incoming Text Messages

Your MTH800L will alert you of an incoming message and enter the inbox automatically, if there is no on-going activity in the terminal.

Scroll to the message and select **Read** soft key. To read a long message, press **More** to read the next page and **Back** to return to the previous page.

Then select **Reply**. Or press  and select to **Store / Delete / Delete All / Forward**.

NOTE

For Long Text Messages Reply, Store and Forward options are not available.

Handling Unread (New) Messages

Press  and select **Messages > Inbox**. Scroll to the message and select **Read** soft key. To read a long message, press **More** to read the next page and **Back** to return to the previous page.

Press  and select to **Store / Delete / Delete All / Reply / Forward / Refresh**.

NOTE

Message contains up to 1000 characters.

NOTE

It is possible to send the message to more than one user. Pick the group from the contact list on your MTH800L.

Tips & Tricks

Modeless Operation

No need to select a mode (Group / Private / Phone) before initiating a call. Just dial a number and press **CType** (call type) soft key to decide what call it is (then press **PTT** or .

Home Key



Not sure where you are? Want to get back to Home display?
Press .

Backlight Control

You can either disable backlight (covert operation) or have it automatically turned on, by pressing any key. Third option is semi-auto, which means that only switching on the radio, pressing assigned button to the backlight feature and charging can trigger backlight.

The backlight remains on until the pre-programmed timer runs out.

Menu Shortcuts

- You can easily access any menu item, by pressing  and a Numeric key. (No delay between  and the key!)
- You can ask your Service Provider to program menu shortcuts.
- You may also define a new shortcut: enter the menu item, press and hold , and follow the instructions in the display.

High/Low Audio Control

You can control audio routing (speaker/earpiece/PHF) for any Private or Group Call via the dedicated Speaker Control key.

However, you can define via the menu to have all Group Calls in high audio ( > **Setup** > **Audio** > **Audio Toggle** >

Always Loud).

NOTE *High/Low audio control is switched via One Touch Button. Contact your service provider for more information.*

Unified Contact List

You can keep several numbers (Private, Mobile, Home, Work, PABX, Other) for the same person under the same contact name. You can create up to 1000 contacts, and have a total of 1000 private numbers and 1000 phone numbers.

Text Size

You can see the text on the display in two sizes: **Standard** or **Zoomed** ( > **Setup > Display > Text Size**).

Group Capacity

Your Service provider can program up to 2048 groups for Trunked Mode, and up to 1024 groups for Direct Mode.

Flexible Folders

You can ask your Service Provider to define how many groups will be in each folder (up to 256 folders).

“My Groups” Folders

You can select any group (TMO or DMO) and add it to your personal folder.

In the Home display, press  to quickly access your “My Groups” folders.

Options (in the Home Display)

You can easily change folder, select groups, switch between TMO and DMO (and vice-versa), and other functions via the Home display Options.

Easy Navigation while in Menu

When scrolling up/down menu items, try also right/left scrolling. (This will select the item or return to previous level.)

Flipped Display On/Off



When this feature is activated, the contents of the display are flipped upside down. This feature is particularly useful if you have to wear the MTH800L on the shoulder, belt, or lapel and at the same time wish to read the display upside down.

To activate/deactivate, press  and select **Setup > Display > Flip Display**. Or press and hold the pre-programmed one-touch button.

Dialed Call List – Quick Access

From the Home display press  to access the list of the last dialed calls.

Automatic Scrolling via Navigation Key



In a list press and hold  or  for automatic scrolling.

Recent Calls Menu – Quick Access

From the Home display press .

Setting Time & Date

Time and date are synchronized by the infrastructure. When not within the infrastructure signal range you can set the values manually.

- To set time press  and select **Setup > Time & Date > Set > Set Time**. Enter time using navigation key and/or numeric keypad.
- To set date press  and select **Setup > Time & Date > Set > Set Date**. Enter date using navigation key and/or numeric keypad.
- To automatically set date and time press  and select **Setup > Time & Date > System Update**. Pick one out of three options accordingly to your needs:
 - **Off** – System Update is turned off
 - **Time only** – time is updated
 - **Time & Offset** – the time is updated automatically according to the current time zone when user is in TMO mode. In DMO mode the radio is using its internal clock.

Template Names

User is able to give the title of the template by his preference. If no default name is given.

Toggling between Talkgroups

You can switch the last two talkgroups in any mode and between the modes. For example when you are in TMO and would like to switch to the last Talkgroup that was in DMO, press and hold One Touch Button. It works in both ways and in one mode. After powering off, the radio remembers your two last Talkgroups.



MTH800L



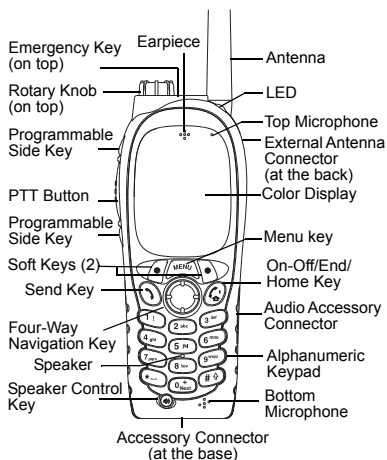

Quick Reference Guide



Turning the MTH800L On/Off

To power the MTH800L on/off, press and hold .

Using the MTH800L Menu System

- To enter the menu, press .
- To scroll through the menu, press .
- To select a menu item, press **Select** soft key or .
- To return to previous level, press **Back** or .
- To exit the menu items, press .

Selecting Trunked/Direct Mode Operation

- Your terminal may be configured with a one-touch button to switch between TMO/DMO. Contact your Service Provider for more information.
- From the Home display press **Optns**, select **Trunked Mode/Direct Mode**.

Making a TMO Group Call

From the Home display navigate to the desired group. Press **Select** soft key (if configured). Press and hold **PTT**. Wait for the talk permit tone (if configured) and talk. Release **PTT** to listen.

Making a DMO Group Call

Enter DMO. Navigate to the desired group. Press **Select** soft key (if configured). Press and hold **PTT**. Wait for the talk permit tone (if configured) and talk. Release **PTT** to listen.

Making a TMO Emergency Group Call

Enter TMO. Press and hold the Emergency button. Emergency alarm is sent automatically. Press and hold **PTT**. Wait for the talk permit tone (if configured) and talk. Release **PTT** to listen. If using **Hot Mic** feature, wait for the **Emergency Mic On** message to appear on the display and talk without pressing **PTT**.

To exit Emergency Mode, press and hold **Exit** soft key.

Making a DMO Emergency Group Call

Enter DMO. Press and hold the Emergency button. Press and hold **PTT**. Wait for the talk permit tone (if configured) and talk. Release **PTT** to listen. To exit Emergency Mode press and hold **Exit** soft key.



Making a TMO Simplex Private Call

From the Home display dial a number. Press **CType** to select the call type (if required). Press and release **PTT**. Ringing sounds. Called party answers. Wait for the called party to finish speaking. Press and hold **PTT**. Wait for the talk permit tone (if configured) and talk. Release **PTT** to listen. Press  to terminate call.

Making a DMO Simplex Private Call

Enter DMO. From the Home display dial a number. Press and hold **PTT**. Wait for the talk permit tone (if configured) and talk. Release **PTT** to listen. Press  to terminate call.

Making a Duplex Private Call/Phone/PABX Call

From the Home display dial a number. Press **CType** to select the call type (if required). Press and release . Ringing sounds. Called party answers. Press  to terminate call.

Answering a Call

Your MTH800L switches to the incoming call and alerts you of the incoming call.

To answer the call, press  for Phone/PABX/Duplex Private calls or press **PTT** for all other calls.

Sending a Status Message

Select the desired group, then

press  and select **Messages**

> **Send Status**. Select status and

press  or **PTT**.

Sending a New Message

Press  and select **Messages**

> **New Message**. Write your message.

Select **Send**, or press  or **PTT**. Select your mail recipient or enter number.

Select **Send**, or press  or **PTT** to send the new message.

Tips & Tricks



- **Home Key**

Not sure where you are? Want to get back to Home display? Press .

- **Backlight Control**

You can disable backlight (covert operation), have it automatically turned on by any key pressed or Semi Auto which turns on the radio by charging and pressing assigned button. You can also press the upper Side key - just to turn On/Off the backlight (if configured).

- **Menu Shortcuts**

You can easily access any menu item, by pressing  and a numeric key. (No delay between  and the key!)

You can ask your Service Provider to program menu shortcuts.

You may also define a new shortcut: enter the menu item, press and

hold , and follow the instructions in the display.

- **High/Low Audio Control**

You can control audio routing (speaker / earpiece/PHF) for any Private or Group Call via the dedicated speaker control key. However, you can define via the menu to have all Group Calls in high audio ( > **Setup > Audio > Audio Toggle**).

- **Unified Contact List**

You can keep several numbers (Private, Mobile, Home, Work, PABX, Other) for the same person under the same contact name.

- **Text Size**

You can see the text on the display in two sizes: **Standard** or **Zoomed** ( > **Setup > Display > Text Size**).

- **“My Groups” Folder**

You can select any group (TMO or DMO) and add it to your personal folder. In the Home display, press  to quickly access your “My Groups” folder.



EN



MOTOROLA

www.motorola.com/tetra

68015000031-C

