

PMMN4140

RM760 IMPRES Windporting Remote Speaker Microphone, Large (IP68)



MN008153A01-AA

MOTOROLA, MOTO, MOTOROLA SOLUTIONS and the Stylized M logo are trademarks or registered trademarks of Motorola Trademark Holdings, LLC and are used under license. All other trademarks are the property of their respective owners.
© 2021 Motorola Solutions, Inc. All rights reserved.
EU Contact: Motorola Solutions, Czerwone Maki 82, 30-392 Krakow, Poland.
UK Contact: Motorola Solutions UK Ltd., Nova South, 160 Victoria Street, London, SW1E 5LB, United Kingdom

UK Contact: Motorola Solutions UK Ltd., Nova South, 160 Victoria Street, London, SW1E 5LB, United Kingdom

Контактна інформація: Моторола Солюшнс Системз Польща вул. Червоне Маки, 82, 30-392 Краків, Польща



Printed In

**Foreword
RF Energy Exposure and Product Safety
Guide for Portable Two-way Radios**

Attention!

Before using this accessory, read this guide which contains important operating instructions for safe usage and RF energy awareness and control for compliance with applicable standards and regulations.

The Remote Speaker Microphone (RSM), when attached to the radio, is restricted to occupational use only to satisfy FCC/ICNIRP RF energy exposure requirements. Before using this product, read the RF energy awareness information and operating instructions in the Product Safety and RF Exposure booklet enclosed with your radio to ensure compliance with RF energy exposure limits.

Acoustic Safety

Exposure to loud noises from any source for extended periods of time may temporarily or permanently affect your hearing. The louder the volume of the radio, the less time is required before your hearing can be affected.

Hearing damage from loud noise is sometimes undetectable at first and can have a cumulative effect.

To protect your hearing:

- Use the lowest volume necessary to do your job.
- Turn up the volume only if you are in noisy surroundings.
- Turn down the volume before attaching headset or earpiece.
- Limit the amount of time you use headsets or earpieces at high volume.
- When using the radio without a headset or earpiece, do not place the speaker of the radio directly against your ear.
- If you experience hearing discomfort, ringing in your ears, or muffled speech, you should stop listening to your radio through your headset or earpiece, and have your hearing checked by your doctor. To change the volume level, refer to Radio Product Safety Leaflet or CPS for Surveillance extra loud (xL) Kit Configurations.

Product Overview

This user manual describes the RM760 IMPRES Windporting Remote Speaker Microphone, Large Basic (IP68), PMMN4140.

RSM Features

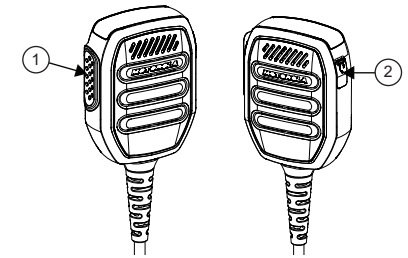
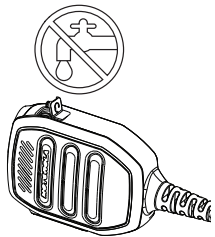

Table 1: RSM Features

No.	Description
1	Push-to-Talk Button
2	Receive-only 3.5 mm Audio Jack (Non-threaded) covered by Dust Cover

Recommended Practices for Remote Speaker Microphone



- Cover the audio jack with dust cover when it is not plugged with earpiece.
- Do not fill water into the audio jack.
- If water enters the audio jack, remove water by shaking the RSM.

Transmitting and Receiving

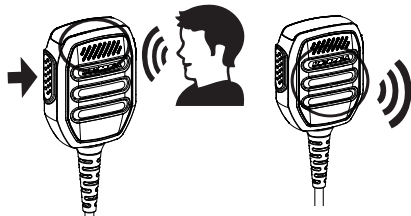

Attaching the RSM to the Radio

Attach the RSM connector to the side connector of the radio. Then secure the connection screw in a clockwise direction until tightened.

Note: To ensure proper operation, turn off the radio before connecting the RSM to the radio. Connecting the RSM to the radio disables the speaker of the radio, but does not disable the microphone and PTT of the radio.

Detaching the RSM from the Radio

1. Unscrew and detach the RSM connector from the radio side connector.
2. Keep the dust cover inserted in the audio jack of the RSM when a secondary accessory is not being used.

Recommended Wearing Position



Cable Management

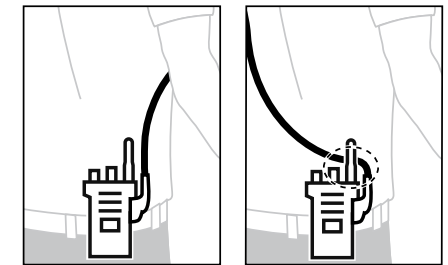

Recommended Not Recommended

To ensure optimum range and user experience, it is recommended to avoid crossing accessory cable with the radio antenna.

Optional Accessories

Table 2: Optional Accessories

Part Number	Description
PMLN8120	Rx only xL Clear Tube Earpiece, 3.5mm Jack

Replacement Parts

Table 3: Replacement Parts

No	Description
1	Low Profile Swivel Clip (PMLN8121)
2	Dust Cover 10pcs/pack (PMLN8122)
3	Coil Cord (PMKN4232)

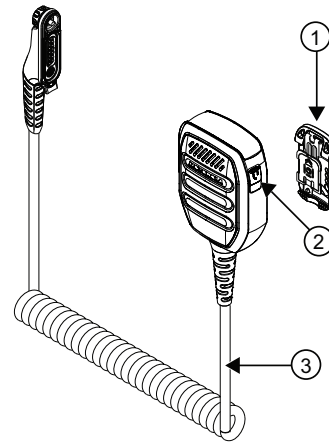

Coil Cord Replacement Procedure

1. Remove the screws to disassemble the RSM.
2. Remove the cable.
3. Reassemble the RSM.

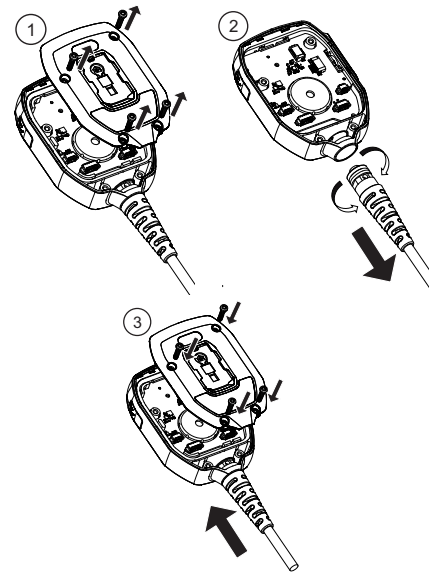

Replacing the Dust Cover

1. Lift both sides of the dust cover.
2. Pull out the dust cover to dismantle it.

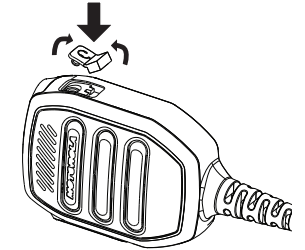

3. Bend the dust cover.
4. Insert to the dust cover slot.

Attaching Swivel Clip

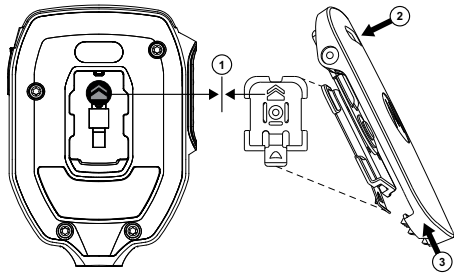

1. Match and align the arrowhead icons and side wings.
2. Push down the top of the clip.
3. Simultaneously, push slide clip upward.

Detaching Swivel Clip

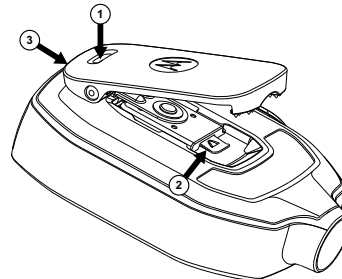

1. Push top of the clip to raise the clip to the highest position.
2. Lift up the bottom release latch.
3. Slide the clip to remove the clip.

Service and Warranty

Motorola Solutions offers warranty for your accessory. Refer to your Motorola Solutions dealer or point-of-purchase for detailed information.

NOTE: Warranty is void after customer replacement of any parts other than replacement parts listed.

Refer to manual MN008152A01 for other languages: <https://learning.motorolasolutions.com>

