

PROFESSIONAL DIGITAL TWO-WAY RADIO SYSTEM

# MOTOTRBO™ XPR™ 4350 / XPR™ 4380 NUMERIC DISPLAY MOBILE USER GUIDE





## Declaration of Conformity

This declaration is applicable to your radio **only** if your radio is labeled with the FCC logo shown below.

### DECLARATION OF CONFORMITY

Per FCC CFR 47 Part 2 Section 2.1077(a)



#### Responsible Party

Name: Motorola Solutions, Inc.

Address: 1301 East Algonquin Road, Schaumburg, IL 60196-1078, U.S.A.

Phone Number: 1-800-927-2744

Hereby declares that the product:

Model Name: **XPR 4350/XPR 4380**

conforms to the following regulations:

FCC Part 15, subpart B, section 15.107(a), 15.107(d) and section 15.109(a)

#### **Class B Digital Device**

As a personal computer peripheral, this device complies with Part 15 of the FCC Rules. This device complies with Industry Canada licence-exempt RSS standard(s). Operation is subject to the following two conditions:

1. This device may not cause harmful interference, and
2. This device must accept any interference received, including interference that may cause undesired operation.

**Note:** This equipment has been tested and found to comply with the limits for a Class B digital device, pursuant to part 15 of the FCC Rules. These limits are designed to provide reasonable protection against harmful interference in a residential installation. This equipment generates, uses and can radiate radio frequency energy and, if not installed and used in accordance with the instructions, may cause harmful interference to radio communications. However, there is no guarantee that interference will not occur in a particular installation.

If this equipment does cause harmful interference to radio or television reception, which can be determined by turning the equipment off and on, the user is encouraged to try to correct the interference by one or more of the following measures:

- Reorient or relocate the receiving antenna.
- Increase the separation between the equipment and receiver.
- Connect the equipment into an outlet on a circuit different from that to which the receiver is connected.
- Consult the dealer or an experienced radio/TV technician for help.

# Contents

This User Guide contains all the information you need to use the MOTOTRBO XPR Series Digital Mobile Radios.

- Declaration of Conformity** . . . . . **i**
- Notes** . . . . . **vi**
- Important Safety Information** . . . . . **vii**
  - Product Safety and RF Exposure Compliance . . . . . **vii**
- Software Version** . . . . . **vii**
- Computer Software Copyrights** . . . . . **viii**
- Getting Started** . . . . . **1**
  - How to Use This Guide . . . . . **1**
  - What Your Dealer/System Administrator Can Tell You . . . . . **1**
  - Powering Up the Radio . . . . . **2**
  - Adjusting the Volume . . . . . **2**
- Identifying Radio Controls** . . . . . **3**
  - Radio Controls . . . . . **3**
  - Programmable Buttons . . . . . **4**
    - Assignable Radio Functions . . . . . **4**
    - Assignable Settings/Utility Functions . . . . . **5**

- Push-To-Talk (PTT) Button . . . . . **5**
- Switching Between Conventional Analog and Digital Mode . . . . . **6**
- IP Site Connect . . . . . **7**
- Capacity Plus . . . . . **7**
- Linked Capacity Plus . . . . . **8**
- Identifying Status Indicators** . . . . . **9**
  - Display Icons . . . . . **9**
  - LED Indicators . . . . . **9**
  - Audio Tones . . . . . **10**
  - Indicator Tones . . . . . **10**
- Receiving and Making Calls** . . . . . **11**
  - Selecting a Zone . . . . . **11**
  - Selecting a Channel . . . . . **12**
  - Receiving and Responding to a Radio Call . . . . . **12**
    - Receiving and Responding to a Group Call . . . . . **13**
    - Receiving and Responding to a Private Call . . . . . **13**
    - Receiving an All Call . . . . . **14**
    - Receiving and Responding to a Phone Call . . . . . **14**
      - Phone Call as Group/Private/All Call . . . . . **14**
  - Making a Radio Call . . . . . **15**
    - Making a Group Call . . . . . **15**
    - Making a Private Call . . . . . **16**
    - Making an All Call . . . . . **16**



Making a Phone Call .....	17	Sending a Quick Text Message .....	27
Stopping a Radio Call .....	18	Privacy .....	27
Talkaround .....	18	Multi-Site Controls .....	28
Permanent Monitor .....	19	Starting an Automatic Site Search .....	28
<b>Advanced Features .....</b>	<b>20</b>	Stopping an Automatic Site Search .....	29
Scan Lists .....	20	Starting a Manual Site Search .....	29
Scan .....	20	Lone Worker .....	29
Starting and Stopping Scan .....	21	Password Lock Features .....	30
Responding to a Transmission During a Scan ..	21	Accessing the Radio from Password .....	30
Deleting a Nuisance Channel .....	22	Unlocking the Radio from Locked State .....	30
Restoring a Nuisance Channel .....	22	Utilities .....	31
Call Indicator Settings .....	22	Setting the Squelch Level .....	31
Escalating Alarm Tone Volume .....	22	Setting the Power Level .....	31
Call Alert Operation .....	22	Turning the Option Board Feature(s) On or Off .	31
Receiving and Responding to a Call Alert .....	22	Turning the Voice Operating Transmission (VOX)	
Making a Call Alert with the One Touch Access Button		Feature On or Off .....	32
.....	23	Turning the Public Address System On or Off ..	32
Emergency Operation .....	23	Turning the External Public Address System On	
Sending an Emergency Alarm .....	24	or Off .....	32
Sending an Emergency Alarm with Call .....	24	Turning Horns/Lights On or Off .....	33
Sending an Emergency Alarm with Voice to		Turning Radio Tones/Alerts On or Off .....	33
Follow .....	25	<b>Accessories .....</b>	<b>34</b>
Reinitiating an Emergency Mode .....	26	Antennas .....	34
Exiting an Emergency Mode .....	26	Audio .....	36
Text Messaging Features .....	27	Cables .....	36

Desktop Accessories .....	36
Mounting Kits .....	36
Remote Mount Adaptor Kits .....	37
Speakers .....	37
Miscellaneous Accessories .....	37
<b>Appendix: Maritime Radio Use in the VHF Frequency Range .....</b>	<b>38</b>
Special Channel Assignments .....	38
Emergency Channel .....	38
Non-Commercial Call Channel .....	38
Operating Frequency Requirements .....	39
<b>Limited Warranty .....</b>	<b>41</b>

---

## Notes

Notes

vi

English



## Important Safety Information

### Product Safety and RF Exposure Compliance



Caution

Before using this product, read the operating instructions for safe usage contained in the Product Safety and RF Exposure booklet enclosed with your radio.

### ATTENTION!

**This radio is restricted to occupational use only to satisfy FCC RF energy exposure requirements.**

Before using this product, read the RF energy awareness information and operating instructions in the Product Safety and RF Exposure booklet enclosed with your radio (Motorola Publication part number 6881095C99) to ensure compliance with RF energy exposure limits.

For a list of Motorola-approved antennas and other accessories, visit the following website:

<http://www.motorolasolutions.com/governmentandenterprise>

*Any modification to this device, not expressly authorized by Motorola, may void the user's authority to operate this device.*

*Under Industry Canada regulations, this radio transmitter may only operate using an antenna of a type and maximum (or lesser) gain approved for the transmitter by Industry Canada. To reduce potential radio interference to other users, the antenna type and its gain should be so chosen that the equivalent isotropically radiated power (e.i.r.p.) is not more than that necessary for successful communication.*

### Software Version

All the features described in the following sections are supported by the radio's software version **R01.09.00** or later.

Please check with your dealer or system administrator for more details of all the features supported.

## Computer Software Copyrights

The Motorola products described in this manual may include copyrighted Motorola computer programs stored in semiconductor memories or other media. Laws in the United States and other countries preserve for Motorola certain exclusive rights for copyrighted computer programs including, but not limited to, the exclusive right to copy or reproduce in any form the copyrighted computer program. Accordingly, any copyrighted Motorola computer programs contained in the Motorola products described in this manual may not be copied, reproduced, modified, reverse-engineered, or distributed in any manner without the express written permission of Motorola. Furthermore, the purchase of Motorola products shall not be deemed to grant either directly or by implication, estoppel, or otherwise, any license under the copyrights, patents or patent applications of Motorola, except for the normal non-exclusive license to use that arises by operation of law in the sale of a product.

The AMBE+2™ voice coding Technology embodied in this product is protected by intellectual property rights including patent rights, copyrights and trade secrets of Digital Voice Systems, Inc.

This voice coding Technology is licensed solely for use within this Communications Equipment. The user of this Technology is explicitly prohibited from attempting to decompile, reverse engineer, or disassemble the Object Code, or in any other way convert the Object Code into a human-readable form.

U.S. Pat. Nos. #5,870,405, #5,826,222, #5,754,974, #5,701,390, #5,715,365, #5,649,050, #5,630,011, #5,581,656, #5,517,511, #5,491,772, #5,247,579, #5,226,084 and #5,195,166.

## Getting Started

Take a moment to review the following:

How to Use This Guide . . . . .	page 1
What Your Dealer/System Administrator Can Tell You . . . . .	page 1
Powering Up the Radio . . . . .	page 2
Adjusting the Volume. . . . .	page 2

### ■ How to Use This Guide

This User Guide covers the basic operation of the MOTOTRBO Mobiles with Numeric Display.

However, your dealer or system administrator may have customized your radio for your specific needs. Check with your dealer or system administrator for more information.

Throughout this publication, the icons below are used to indicate features supported in either the conventional Analog mode or conventional Digital mode:



Indicates a conventional **Analog Mode-Only** feature.



Indicates a conventional **Digital Mode-Only** feature.

For features that are available in **both** Analog and Digital modes, **no** icon is shown.

For features that are available in a conventional multi-site mode, see **IP Site Connect** on page 7 for more information.

Selected features are **also** available on the single-site trunking mode, Capacity Plus. See **Capacity Plus** on page 7 for more information.

Selected features are also available in the multi-site trunking mode, Linked Capacity Plus. See **Linked Capacity Plus** on page 8 for more information.

### ■ What Your Dealer/System Administrator Can Tell You

You can consult your dealer or system administrator about the following:

- Is your radio programmed with any preset conventional channels?
- Which buttons have been programmed to access other features?
- What optional accessories may suit your needs?
- What are the best radio usage practices for effective communication?
- What maintenance procedures will help promote longer radio life?

## ■ Powering Up the Radio

Press the **On/Off Button** briefly.

The green LED blinks and the numeric display screen lights up.

A brief tone sounds, indicating that the power up test is successful.

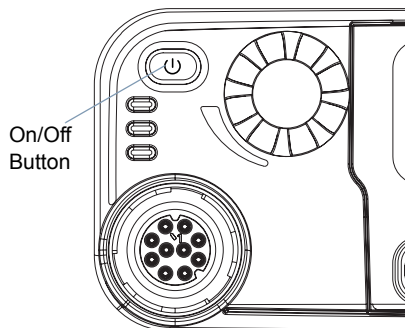

**NOTE:** There is no power up tone if the radio tones/alerts function is disabled (see **Turning Radio Tones/Alerts On or Off** on page 33).

If your radio does not power up, contact your dealer.

*To turn off the radio, press and hold the On/Off Button.*

## ■ Adjusting the Volume

To increase the volume, turn the **Volume Knob** clockwise.

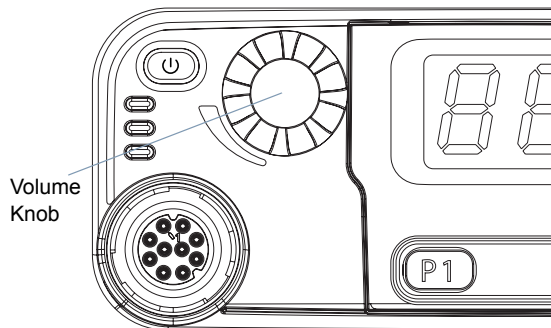

*To decrease the volume, turn this knob counterclockwise.*

**NOTE:** Your radio can be programmed to have a minimum volume offset where the volume level cannot be turned down fully. Check with your dealer or system administrator for more information.

# Identifying Radio Controls

Take a moment to review the following:

- Radio Controls . . . . . page 3
- Programmable Buttons . . . . . page 4
- Push-To-Talk (PTT) Button . . . . . page 5
- Switching Between Conventional Analog and Digital Mode . . . . . page 6
- IP Site Connect . . . . . page 7
- Capacity Plus . . . . . page 7
- Linked Capacity Plus . . . . . page 8

## ■ Radio Controls

- 1 On/Off Button
- 2 Volume Knob
- 3 Display
- 4 Channel Rocker
- 5 Speaker
- 6 Front Button P2\*
- 7 Front Button P1\*

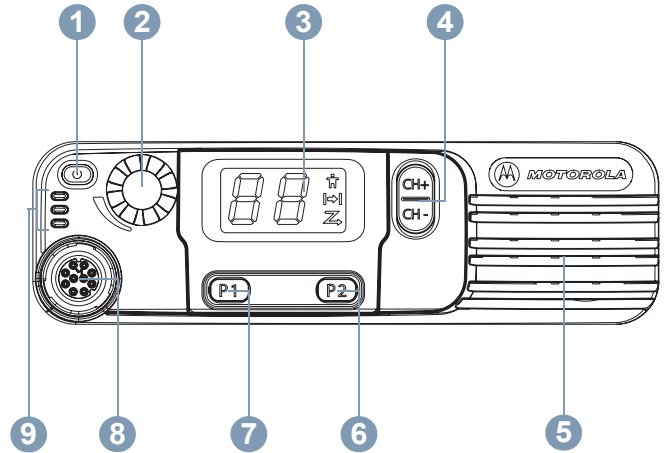

- 8 Accessory Connector
- 9 LED Indicators

*\* These buttons are programmable.*

## ■ Programmable Buttons

Your dealer can program the programmable buttons as shortcuts to **radio functions** or up to a maximum of six (6) **preset channels/groups** depending on the duration of a button press:

- Short press – Pressing and releasing rapidly.
- Long press – Pressing and holding for the programmed duration.
- Hold down – Keeping the button pressed.

**NOTE:** The programmed duration of a button press is applicable for all assignable radio/utility functions or settings. See **Emergency Operation** on page 23 for more information on the programmed duration of the **Emergency** button.

### 📄 Assignable Radio Functions

**Emergency** – Depending on the programming, initiates or cancels an Emergency Alarm or Call.

**Ext PA On/Off** – Toggles the audio routing between the connected public address (PA) loudspeaker amplifier and the radio's internal public address (PA) system.

**Manual Site Roam**<sup>\*‡</sup>  – Starts the manual site search.

**Nuisance Channel Delete**<sup>\*‡</sup> – Temporarily removes an unwanted channel, except for the Selected Channel, from the scan list. The Selected Channel refers to the user's selected zone/channel combination from which scan is initiated.

**One Touch Access**  – Directly initiates a predefined Private, Phone or Group Call, a Call Alert or a Quick Text message, or returns the user to a preset channel.

**Option Board Feature** – Toggles option board feature(s) on or off for option board-enabled channels.

**PA On/Off** – Toggles the radio's internal public address (PA) system on or off.

**Permanent Monitor** <sup>\*‡</sup> – Monitors a selected channel for all radio traffic until function is disabled.

**Phone Exit**  – Ends a Phone Call.

**Privacy**  – Toggles privacy on or off.

**Repeater/Talkaround**<sup>\*‡</sup> – Toggles between using a repeater and communicating directly with another radio.

**Scan**<sup>\*‡</sup> – Toggles scan on or off.

**Site Lock On/Off**<sup>\*</sup>  – Toggles the automatic site roam on or off.

*\* Not applicable in Capacity Plus*

*‡ Not applicable in Linked Capacity Plus*

**Telemetry Control**  – Controls the Output Pin on a local or remote radio.

**Transmit Interrupt Remote Dekey**  – Stops an ongoing interruptible call to free the channel.

**Voice Operating Transmission (VOX)** – Toggles VOX on or off.

**Zone** – Allows selection from a list of zones.

### Assignable Settings/Utility Functions

**All Tones/Alerts** – Toggles all tones on or off.

**Power Level** – Toggles transmit power level between high and low.

**Squelch**  – Toggles squelch level between normal and tight.

## ■ Push-To-Talk (PTT) Button

The **PTT** button on the side of the microphone serves two basic purposes:

- While a call is in progress, the **PTT** button allows the radio to transmit to other radios in the call.

Press and hold down **PTT** button to talk. Release the **PTT** button to listen.

The microphone is activated when the **PTT** button is pressed.

- While a call is not in progress, the **PTT** button is used to make a new call (see **Making a Radio Call** on page 15).

*Depending on programming, if the Talk Permit Tone or the **PTT** Sidetone  is enabled, wait until the short alert tone ends before talking.*

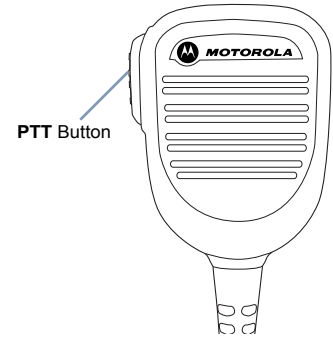

- During a call, if the Channel Free Indication feature is enabled on your radio (programmed by your dealer), you will hear a short alert tone the moment the target radio (the radio that is receiving your call) releases the **PTT** button, indicating the channel is free for you to respond.
- You will also hear a continuous talk prohibit tone, if your call is interrupted, indicating that you should release the PTT button, for example when the radio receives an Emergency Call.

You can turn off the Channel Free Indication tone or the **PTT Sidetone**  by disabling all radio tones and alerts (see **Turning Radio Tones/Alerts On or Off** on page 33).

## Switching Between Conventional Analog and Digital Mode

Each channel in your radio can be configured as a conventional analog or conventional digital channel. Use the Channel Rocker to switch between an analog or a digital channel.

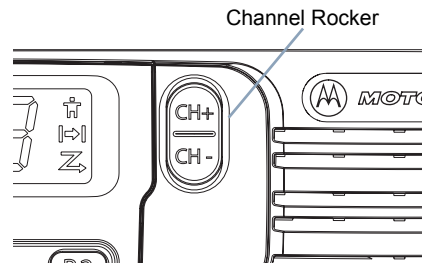

When switching from digital to analog mode, certain features are unavailable.

Your radio also has features available in both analog and digital mode. However, the minor differences in the way each feature works does **NOT** affect the performance of your radio.

**NOTE:** Your radio also switches between digital and analog modes during a dual mode scan (see **Scan** on page 20).



## ■ IP Site Connect

---

This feature allows your radio to extend conventional communication beyond the reach of a single site, by connecting to different available sites which are connected via an Internet Protocol (IP) network.

When the radio moves out of range from one site and into the range of another, it connects to the new site's repeater to send or receive calls/data transmissions. Depending on your settings, this is done automatically or manually.

If the radio is set to do this automatically, it scans through all available sites when the signal from the current site is weak or when the radio is unable to detect any signal from the current site. It then locks on to the repeater with the strongest Received Signal Strength Indicator (RSSI) value.

In a manual site search, the radio searches for the next site in the roam list that is currently in range (but which may not have the strongest signal) and locks on to it.

**NOTE:** Each channel can only have either Scan or Roam enabled, not both at the same time.

Channels with this feature enabled can be added to a particular roam list. The radio searches the channel(s) in the roam list during the automatic roam operation to locate the best site.

A roam list supports a maximum of 16 channels (including the Selected Channel).

**NOTE:** You cannot manually add or delete an entry to the roam list. Check with your dealer or system administrator for more information.

## ■ Capacity Plus

---

Capacity Plus is a single-site trunking configuration of the MOTOTRBO radio system, which uses a pool of channels to support hundreds of users and up to 254 Groups. This feature allows your radio to efficiently utilize the available number of programmed channels while in Repeater Mode.

You hear a negative indicator tone if you try to access a feature not applicable to Capacity Plus via a programmable button press.

Your radio also has features that are available in conventional digital mode, IP Site Connect, Capacity Plus and Linked Capacity Plus. However, the minor differences in the way each feature works does NOT affect the performance of your radio.

Check with your dealer or system administrator for more information on this configuration.

## ■ Linked Capacity Plus

---

Linked Capacity Plus is a multi-site multi-channel trunking configuration of the MOTOTRBO radio system, combining the best of both Capacity Plus and IP Site Connect configurations.

Linked Capacity Plus allows your radio to extend trunking communication beyond the reach of a single site, by connecting to different available sites which are connected via an Internet Protocol (IP) network. It also provides an increase in capacity by efficiently utilizing the combined available number of programmed channels supported by each of the available sites.

When the radio moves out of range from one site and into the range of another, it connects to the new site's repeater to send or receive calls/data transmissions. Depending on your settings, this is done automatically or manually.

If the radio is set to do this automatically, it scans through all available sites when the signal from the current site is weak or when the radio is unable to detect any signal from the current site. It then locks on to the repeater with the strongest Received Signal Strength Indicator (RSSI) value.

In a manual site search, the radio searches for the next site in the roam list that is currently in range (but which may not have the strongest signal) and locks on to it.

Any channel with Linked Capacity Plus enabled can be added to a particular roam list. The radio searches these channels during the automatic roam operation to locate the best site.

**NOTE:** You cannot manually add or delete an entry to the roam list. Check with your dealer or system administrator for more information.

Similar to Capacity Plus, icons of features not applicable to Linked Capacity Plus are not available in the menu. You hear a negative indicator tone if you try to access a feature not applicable to Linked Capacity Plus via a programmable button press.

Check with your dealer or system administrator for more information on this configuration.

## Identifying Status Indicators

Your radio indicates its operational status through the following:

Display Icons . . . . .	page 9
LED Indicators . . . . .	page 9
Audio Tones . . . . .	page 10
Indicator Tones . . . . .	page 10

### ■ Display Icons

The seven-segment display shows radio channel and status.

The following are the icons that appear on the radio's display.



#### **Private Call**

Indicates a Private Call in progress.



#### **Talkaround\*‡**

In the absence of a repeater, radio is currently configured for direct radio to radio communication.



#### **Scan\*‡**

Scan feature is activated.

\* Not applicable in Capacity Plus

‡ Not applicable in Linked Capacity Plus

### ■ LED Indicators

LED indicators show the operational status of your radio.

**Blinking red** – Radio is receiving an emergency transmission or has failed the self-test upon powering up.

**Solid yellow** – Radio is monitoring a channel.

**Blinking yellow** – Radio is scanning for activity or receiving a Call Alert, or all local Linked Capacity Plus channels are busy.

**Double blinking yellow** – Radio is no longer connected to the repeater while in Capacity Plus or Linked Capacity Plus, all Capacity Plus channels or Linked Capacity Plus channels are currently busy.

**Rapidly blinking yellow** – Radio is actively searching for a new site. 

**Solid green** – Radio is transmitting.

**Blinking green** – Radio is powering up, receiving a non-privacy-enabled call or data, or detecting activity over the air.

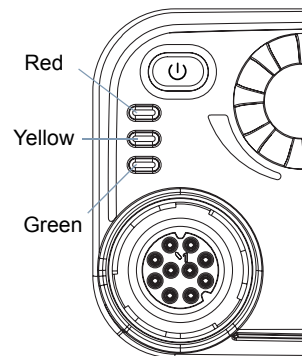

**Rapidly blinking green** – Radio is receiving a privacy-enabled call or data. 

**NOTE:** While in conventional mode, when the green LED blinks, it indicates the radio detects activity over the air. Due to the nature of the digital protocol, this activity may or may not affect the radio's programmed channel.

For Capacity Plus and Linked Capacity Plus, there is no LED indication when the radio is detecting activity over the air.

Upon a **PTT** button press, if the radio is programmed for polite operation, the radio automatically determines whether a transmission is permitted via a Talk Permit or a Talk Denial tone.

## ■ Audio Tones

---

Alert tones provide you with audible indications of the radio's status or the radio's response to data received.

**Continuous Tone**  A monotone sound. Sounds continuously until termination.

**Periodic Tone**  Sounds periodically depending on the duration set by the radio. Tone starts, stops, and repeats itself.

**Repetitive Tone**  A single tone that repeats itself until it is terminated by the user.

**Momentary Tone**  Sounds only once for a short period of time defined by the radio.

## ■ Indicator Tones

---

High pitched tone  Low pitched tone 

 Positive Indicator Tone

 Negative Indicator Tone

## Receiving and Making Calls

Once you understand how your MOTOTRBO Mobile is configured, you are ready to use your radio.

Use this navigation guide to familiarize yourself with the basic Call features:

Selecting a Zone . . . . .	page 11
Selecting a Channel . . . . .	page 12
Receiving and Responding to a Radio Call . . . . .	page 12
Making a Radio Call . . . . .	page 15
Stopping a Radio Call . . . . .	page 18
Talkaround . . . . .	page 18
Permanent Monitor . . . . .	page 19

## Selecting a Zone

A zone is a group of channels. Your radio supports up to a maximum of 2 zones, with a maximum of 32 channels per zone.

### Procedure:

- 1 Press the programmed **Zone** button.
- 2 You hear a positive indicator tone, indicating the radio has switched from Zone 1 to Zone 2.

### OR

You hear a negative indicator tone, indicating the radio has switched from Zone 2 to Zone 1.

## ■ Selecting a Channel

Transmissions are sent and received on a channel. Depending on your radio's configuration, each channel may have been programmed differently to support different groups of users or supplied with different features. After selecting the relevant Zone, select the relevant channel you require to transmit or receive on

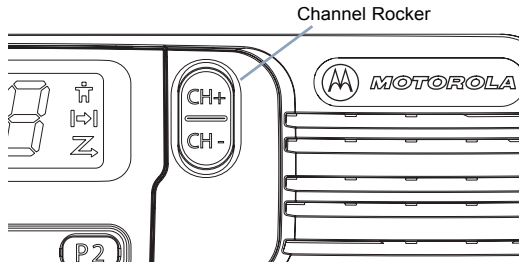

### Procedure:

Once the required zone is set (if you have multiple zones in your radio), press the Channel Rocker to select the number that represents the channel, subscriber ID, or group ID.

**OR**

Press the programmed **One Touch Access** button to select the preset channel assigned to the button.

## ■ Receiving and Responding to a Radio Call

Once the channel, subscriber ID, or group ID is set, you can proceed to receive and respond to calls.

*The green LED lights up while the radio is transmitting and blinks when the radio is receiving.*

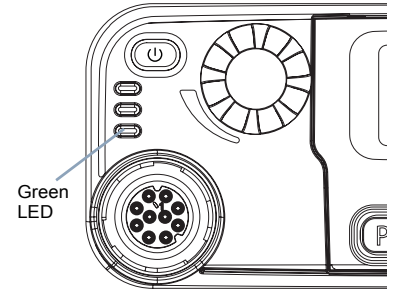

**NOTE:** The green LED lights up while the radio is transmitting and blinks rapidly when the radio is receiving a privacy-enabled call.

To unscramble a privacy-enabled call, your radio must have the same Privacy Key, OR the same Key Value and Key ID (programmed by your dealer) as the transmitting radio (the radio you are receiving the call from).



See **Privacy** on page 27 for more information. 

## Receiving and Responding to a Group Call

To receive a call made to a group of users, your radio must be configured as part of that group.

### Procedure:

When you receive a Group Call:

- 1 The green LED blinks. Your radio unmutes and the incoming call sounds through the radio's speaker.
  -  If the Channel Free Indication feature is enabled, you will hear a short alert tone the moment the transmitting radio releases the **PTT** button, indicating the channel is free for you to respond.  
Press the **PTT** button to respond to the call.
- OR**
-  If the Voice Interrupt feature is enabled, press the **PTT** button to stop the current call from the transmitting radio and free the channel for you to talk/respond.

---

- 2 The green LED lights up.

---

- 3 Wait for the Talk Permit Tone to finish (if enabled) and speak clearly into the microphone.
  - OR**
  -  Wait for the **PTT** Sidetone to finish (if enabled) and speak clearly into the microphone.

---

- 4 Release the **PTT** button to listen.

---

- 5 If there is no voice activity for a predetermined period of time, the call ends.
- 

See *Making a Group Call* on page 15 for details on making a Group Call.

## Receiving and Responding to a Private Call

A Private Call is a call from an individual radio to another individual radio.

### Procedure:

When you receive a private call:

- 1 The green LED blinks. Your radio unmutes and the incoming call sounds through the radio's speaker.

---

- 2 If the Channel Free Indication feature is enabled, you will hear a short alert tone the moment the transmitting radio releases the **PTT** button, indicating the channel is free for you to respond.  
Press the **PTT** button to respond to the call.
  - OR**
  - If the Voice Interrupt feature is enabled, press the **PTT** button to stop the current call from the transmitting radio and free the channel for you to talk/respond.

---

- 3 The green LED lights up.

---

- 4 Wait for the Talk Permit Tone to finish (if enabled) and speak clearly into the microphone.

---

- 5 Release the **PTT** button to listen.
- 6 If there is no voice activity for a predetermined period of time, the call ends.
- 7 You hear a short tone.

See **Making a Private Call** on page 16 for more details on making a private call.

### Receiving an All Call

An All Call is a call from an individual radio to every radio on the channel. It is used to make important announcements requiring the user's full attention.

#### **Procedure:**

When you receive an All Call:

- 1 A tone sounds and the green LED blinks. Your radio unmutes and the incoming call sounds through the radio's speaker.
- 2 An all call does not wait for a predetermined period of time before ending.
  -  If the Channel Free Indication feature is enabled, you will hear a short alert tone the moment the transmitting radio releases the **PTT** button, indicating the channel is now available for use.

*You cannot respond to an All Call.*

**NOTE:** The radio stops receiving the All Call if you switch to a different channel while receiving the call. During an All Call, you will **not** be able to use any programmed button functions until the call ends.

### Receiving and Responding to a Phone Call

**NOTE:** If Phone Call capability is enabled, you are able to respond to a Phone Call. Check with your dealer or system administrator for more information.

### Phone Call as Group/Private/All Call

#### **Procedure:**

When you receive a Phone Call as a Group/Private/All Call: Press the **PTT** button to talk and release it to listen.

**NOTE:** When you receive a Phone Call as an All Call, you can respond to the call or end the call, only if an All Call type is assigned to the channel.



## ■ Making a Radio Call

---

After selecting your channel, you can select a subscriber alias or ID, or group alias or ID by using:

- Channel Rocker
- A programmed **One Touch Access** button 

**NOTE:** Your radio must have the Privacy feature enabled on the channel to send a privacy-enabled transmission. Only target radios with the same Privacy Key OR the same Key Value and Key ID as your radio will be able to unscramble the transmission.

See **Privacy** on page 27 for more information. 

The One Touch Access feature allows you to make a Group, Private or Phone Call to a predefined ID easily. This feature can be assigned to a short or long programmable button press. You can ONLY have one ID assigned to a **One Touch Access** button. Your radio can have multiple **One Touch Access** buttons programmed.

## Making a Group Call

To make a call to a group of users, your radio must be configured as part of that group.

### Procedure:

- 1 Select the channel with the active group alias or ID. See **Selecting a Channel** on page 12.  
**OR**  
Press the programmed **One Touch Access** button.

---
- 2 Press the **PTT** button to make the call. The green LED lights up.

---
- 3 Wait for the Talk Permit Tone to finish (if enabled) and speak clearly into the microphone.  
**OR**  
 Wait for the **PTT** Sidetone to finish (if enabled) and speak clearly into the microphone.

---
- 4 Release the **PTT** button to listen. When the target radio responds, the green LED blinks.

---
- 5  If the Channel Free Indication feature is enabled, you will hear a short alert tone the moment the target radio releases the **PTT** button, indicating the channel is free for you to respond. Press the **PTT** button to respond.  
**OR**  
If there is no voice activity for a predetermined period of time, the call ends.

---

## Making a Private Call

While you can receive and/or respond to a Private Call initiated by an authorized individual radio, your radio must be programmed for you to initiate a Private Call.

There are two types of Private Calls. The first type, where a radio presence check is performed prior to setting up the call, while the other sets up the call immediately.

Only **one** of these call types can be programmed to your radio by your dealer.

You will hear a negative indicator tone, when you make a Private Call via the **One Touch Access** button or the Channel Rocker, if this feature is not enabled.

Use the Quick Text Message or Call Alert features to contact an individual radio. See **Text Messaging Features** on page 27 or **Call Alert Operation** on page 22 for more information.

### Procedure:

- 1 Select the channel with the active subscriber alias or ID. See **Selecting a Channel** on page 12.  
**OR**  
Press the programmed **One Touch Access** button.
- 2 Press the **PTT** button to make the call. The green LED lights up.
- 3 Wait for the Talk Permit Tone to finish (if enabled) and speak clearly into the microphone.

- 4 Release the **PTT** button to listen. When the target radio responds, the green LED blinks.
- 5 If the Channel Free Indication feature is enabled, you will hear a short alert tone the moment the target radio releases the **PTT** button, indicating the channel is free for you to respond. Press the **PTT** button to respond.  
**OR**  
If there is no voice activity for a predetermined period of time, the call ends.
- 6 You hear a short tone.

## Making an All Call

This feature allows you to transmit to all users on the channel. Your radio must be programmed to allow you to use this feature.

### Procedure:

- 1 Select the channel with the active All Call group alias or ID. See **Selecting a Channel** on page 12.
- 2 Press the **PTT** button to make the call. The green LED lights up.
- 3 Wait for the Talk Permit Tone to finish (if enabled) and speak clearly into the microphone.  
**OR**  
 Wait for the **PTT** Sidetone to finish (if enabled) and speak clearly into the microphone.

*Users on the channel cannot respond to an All Call.*

## **Making a Phone Call**

**NOTE:** When you attempt to make or end a Phone Call without the access and deaccess codes preconfigured, the attempt fails and a negative indicator tone sounds.

### **Procedure:**

- 1** Press the programmed **One Touch Access** button to make a Phone Call to the predefined ID.  
If the entry for the **One Touch Access** button is empty, a negative indicator tone sounds.

---

- 2** If successful:  
The DTMF tone sounds. You hear the dialing tone of the telephone user.  
**OR**  
If unsuccessful:  
A negative indicator tone sounds and the Phone Call attempt fails. Repeat Step 1.

- 3** Press the **PTT** button to talk and release it to listen.

---

- 4** Press the programmed **Phone Exit** button to end the call and a DTMF tone sounds.

---

- 5** If successful:  
A tone sounds and your radio exits the Phone Call.  
**OR**  
If unsuccessful:  
A negative indicator tone sounds and your radio returns to the Phone Call. Repeat Step 4 or wait for the telephone user to end the call.

*For a Phone Call, you hear a short tone when making the call fails.*

## ■ Stopping a Radio Call

---

This feature allows you to stop an ongoing Group or Private Call to free the channel for transmission. For example, when a radio experiences a “stuck microphone” condition where the **PTT** button is inadvertently pressed by the user.

Your radio must be programmed to allow you to use this feature.

### Procedure:

While on the required channel:

- 1 Press the programmed **Transmit Interrupt Remote Dekey** button.
  - 2 Wait for acknowledgment.
  - 3 The radio sounds a positive indicator tone, indicating that the channel is now free.  
**OR**  
The radio sounds a negative indicator tone, indicating that the radio is unable to free the channel.
- 

*Your radio sounds a negative indicator tone until you release the **PTT** button, if it is transmitting an interruptible call that is stopped via this feature.*

## ■ Talkaround

---

You can continue to communicate when your repeater is not operating, or when your radio is out of the repeater’s range but within talking range of other radios. This is called “talkaround”.

**NOTE:** This feature is not applicable in Capacity Plus and Linked Capacity Plus.

### Procedure:

- 1 Press the programmed **Repeater/Talkaround** button.
  - 2 You hear a positive indicator tone, indicating the radio is in Talkaround mode. The Talkaround icon is displayed.  
**OR**  
You hear a negative indicator tone, indicating the radio is in Repeater mode. The Talkaround icon is turned off.
- 

*The Talkaround setting is retained even after powering down.*

## ■ Permanent Monitor

---

Use the Permanent Monitor feature to continuously monitor a selected channel for activity.

**NOTE:** This feature is not applicable in Capacity Plus and Linked Capacity Plus.

**Procedure:**

- 1 Press the programmed **Permanent Monitor** button.
- 2 Radio sounds alert tone, and the yellow LED lights up.
- 3 Press the programmed **Permanent Monitor** button to remove the radio from permanent monitor mode.
- 4 Radio sounds an alert tone and the LED turns off.

## Advanced Features

Use this navigation guide to learn more about advanced features available with your radio:

Scan Lists . . . . .	page 20
Scan . . . . .	page 20
Call Indicator Settings . . . . .	page 22
Call Alert Operation . . . . .	page 22
Emergency Operation . . . . .	page 23
Text Messaging Features . . . . .	page 27
Privacy . . . . .	page 27
Multi-Site Controls . . . . .	page 28
Lone Worker . . . . .	page 29
Password Lock Features . . . . .	page 30
Utilities . . . . .	page 31

## Scan Lists

Scan lists are created and assigned to individual channels/groups. Your radio scans for voice activity by cycling through the channel/group sequence specified in the scan list for the current channel.

Your radio supports up to 250 scan lists, with a maximum of 16 members in a list. Each scan list shall support a mixture of both analog and digital entries.

**NOTE:** This feature is not applicable in Capacity Plus and Linked Capacity Plus.

## Scan

When you start a scan, your radio cycles through the programmed scan list for the current channel looking for voice activity.

The yellow LED blinks and you see the scan icon on the display.

During a dual mode scan, if you are on a digital channel, and your radio locks onto an analog channel, it automatically switches from digital mode to analog mode for the duration of the call. This is also true for the reverse.

There are two types of scans:

- **Main Channel Scan (Manual):** Your radio scans all the channels/groups in your scan list. On entering scan, your radio may – depending on the settings – automatically start on the last scanned “active” channel/group or on the channel where scan was initiated.
- **Auto Scan (Automatic):** Your radio automatically starts scanning when you select a channel/group that has Auto Scan enabled.

**NOTE:** This feature is not applicable in Capacity Plus and Linked Capacity Plus.

### Starting and Stopping Scan



**Procedure:**

- 1 Press the programmed **Scan** button.  
**OR**  
Use the Channel Rocker to select a channel with Auto Scan enabled.
- 2 When Scan is enabled, the yellow LED blinks and you hear a positive indicator tone. The scan icon is displayed.  
**OR**  
When Scan is disabled, the LED turns off and you hear a negative indicator tone. The scan icon turns off.

### Responding to a Transmission During a Scan

During scanning, your radio stops on a channel/group where activity is detected. The radio stays on that channel for a programmed time period known as “hang time”.

**Procedure:**

- 1  If the Channel Free Indication feature is enabled, you will hear a short alert tone the moment the transmitting radio releases the **PTT** button, indicating the channel is free for you to respond.
- 2 Press the **PTT** button during hang time. The green LED lights up.
- 3 Wait for the Talk Permit Tone to finish (if enabled) and speak clearly into the microphone.  
**OR**  
 Wait for the **PTT** Sidetone to finish (if enabled) and speak clearly into the microphone.
- 4 Release the **PTT** button to listen.
- 5 If you do not respond within the hang time, the radio returns to scanning other channels/groups.

## Deleting a Nuisance Channel

If a channel continually generates unwanted calls or noise (termed a “nuisance” channel), you can temporarily remove the unwanted channel from the scan list.

This capability does not apply to the channel designated as the Selected Channel.

### Procedure:

- 1 When your radio “locks on to” an unwanted or nuisance channel, press the programmed **Nuisance Channel Delete** button until you hear a tone.
- 2 Release the **Nuisance Channel Delete** button. The nuisance channel is deleted.

## Restoring a Nuisance Channel

### Procedure:

To restore the deleted nuisance channel, do **one** of the following:

- Turn the radio off and power it on again, **OR**
- Stop and restart a scan via the programmed **Scan** button, **OR**
- Change the channel via the Channel Rocker.

## ■ Call Indicator Settings

---

You can turn on or off the ringing tones for a received Private Call (see **Turning Radio Tones/Alerts On or Off** on page 33).

## Escalating Alarm Tone Volume

Your radio can be programmed by your dealer to continually alert you when a radio call remains unanswered. This is done by automatically increasing the alarm tone volume over time.

This feature is known as Escalert.

## ■ Call Alert Operation

---

Call Alert paging enables you to alert a specific radio user to call you back when they are able to do so.

This feature is accessible via a programmed **One Touch Access** button.

## Receiving and Responding to a Call Alert

### Procedure:

When you receive a Call Alert page:

- 1 You hear a repetitive tone. The yellow LED blinks.
- 2 Press the **PTT** button within four (4) seconds of receiving a Call Alert page to respond to the Private Call.



## Making a Call Alert with the One Touch Access

### Button

#### Procedure:

- 1 Press the programmed **One Touch Access** button to make a Call Alert to the predefined ID.
- 2 The green LED lights up when your radio is sending the Call Alert.
- 3 If the Call Alert acknowledgement is received, two chirps sound.  
**OR**  
If the Call Alert acknowledgement is not received, a low-pitch tone sounds.

## ■ Emergency Operation

An Emergency Alarm is used to indicate a critical situation. You are able to initiate an Emergency at any time, in any state, even when there is activity on the current channel.

Your dealer can set the duration of a button press for the programmed **Emergency** button, except for long press, which is similar with all other buttons:

- Short press – Between 0.05 seconds and 0.75 seconds
- Long press – Between 1.00 second and 3.75 seconds

The **Emergency** button is assigned with the Emergency On/ Off feature. Check with your dealer for the assigned operation of the **Emergency** button.

*If short press the **Emergency** button is assigned to turn on the Emergency mode, then long press the **Emergency** button is assigned to exit the Emergency mode.*

*If long press the **Emergency** button is assigned to turn on the Emergency mode, then short press the **Emergency** button is assigned to exit the Emergency mode.*

Your radio supports **three** Emergency Alarms:

- Emergency Alarm
- Emergency Alarm with Call
- Emergency Alarm with Voice to Follow 

In addition, each alarm has the following types:

- **Regular** – Radio transmits an alarm signal and shows audio and/or visual indicators.
- **Silent** – Radio transmits an alarm signal without any audio or visual indicators. Radio receives calls without any sound through the radio's speaker, until you press the **PTT** button to initiate the call.
- **Silent with Voice** – Radio transmits an alarm signal without any audio or visual indicators, but allow incoming calls to sound through the radio's speaker.

Only **one** of the Emergency Alarms above can be assigned to the programmed **Emergency** button or the **Emergency** footswitch.

### Sending an Emergency Alarm

This feature allows you to send an Emergency Alarm, a non-voice signal, which triggers an alert indication on a group of radios.

#### Procedure:

- 1 Press the programmed **Emergency On** button or the **Emergency** footswitch.
- 2 The green LED lights up.

- 3 When an Emergency Alarm acknowledgment is received, the Emergency tone sounds. The green LED blinks.  
**OR**

If your radio does not receive an Emergency Alarm acknowledgement, and after all retries have been exhausted, a low-pitch tone sounds.

- 4 Radio exits the Emergency Alarm mode.

*If your radio is set to Silent, it will not display any audio or visual indicators during Emergency mode.*

### Sending an Emergency Alarm with Call

This feature allows you to send an Emergency Alarm to a group of radios. Upon acknowledgement by a radio within the group, the group of radios can communicate over a programmed Emergency channel.

#### Procedure:

- 1 Press the programmed **Emergency On** button or press the **Emergency** footswitch.
- 2 The green LED lights up.
- 3 When an Emergency Alarm acknowledgment is received, the Emergency tone sounds. The green LED blinks.
- 4 Press the **PTT** button to make the call. The green LED lights up.

- 5 Wait for the Talk Permit Tone to finish (if enabled) and speak clearly into the microphone.

**OR**

-  Wait for the **PTT** Sidetone to finish (if enabled) and speak clearly into the microphone.

- 6 Release the **PTT** button to listen.

- 7 When the channel is free for you to respond, a short

alert tone sounds ( if the Channel Free Indication feature is enabled). Press the **PTT** button to respond.

**OR**

Once your call ends, press the programmed **Emergency Off** button to exit the Emergency mode.

*If your radio is set to Silent, it will not display any audio or visual indicators during Emergency mode, or allow any received calls to sound through the radio's speaker, until you press the **PTT** button to initiate the call.*

*If your radio is set to Silent with Voice, it will not display any audio or visual indicators during Emergency mode, but allow incoming calls to sound through the radio's speaker. The indicators will only appear once you press the **PTT** button to initiate, or respond to, the call.*

## Sending an Emergency Alarm with Voice to

### Follow

This feature allows you to send an Emergency Alarm to a group of radios. Your radio's microphone is automatically activated, allowing you to communicate with the group of radios without pressing the **PTT** button.

This activated microphone state is also known as "hot mic".

If you press the **PTT** button during the programmed hot mic transmission period, the radio ignores the **PTT** press and remains in Emergency mode.

**NOTE:** If you press the **PTT** button during hot mic, and continue to press it after the hot mic duration expires, the radio continues to transmit until you release the **PTT** button.

#### Procedure:

- 1 Press the programmed **Emergency On** button or the **Emergency** footswitch.
- 2 The green LED lights up.
- 3 Once a tone sounds, speak clearly into the microphone. When hot mic has been enabled, the radio automatically transmits without a **PTT** press until the hot mic duration expires.

- 4 While transmitting, the green LED lights up.
- 5 Once the hot mic duration expires, the radio automatically stops transmitting. To transmit again, press the **PTT** button.

*If your radio is set to Silent, it will not display any audio or visual indicators during Emergency mode, or allow any received calls to sound through the radio's speaker, until the programmed hot mic transmission period is over, and you press the **PTT** button.*

*If your radio is set to Silent with Voice, it will not display any audio or visual indicators during Emergency mode when you are making the call with hot mic, but allow sound through the radio's speaker when the target radio responds after the programmed hot mic transmission period is over. The indicators will only appear when you press the **PTT** button.*

**NOTE:** If the Emergency Alarm request fails, the radio does not retry to send the request, and enters the hot mic state directly.

## Reinitiating an Emergency Mode

**NOTE:** This feature is only applicable to the radio sending the Emergency Alarm.

There are two instances where this can happen:

- You change the channel while the radio is in Emergency mode. This exits the Emergency mode. If Emergency Alarm is enabled on this new channel, the radio reinitiates Emergency.
- You press the programmed **Emergency On** button during an Emergency initiation/transmission state. This causes the radio to exit this state, and to reinitiate Emergency.

## Exiting an Emergency Mode

**NOTE:** This feature is only applicable to the radio sending the Emergency Alarm.

Your radio exits Emergency mode when **one** of the following occurs:

- Emergency Alarm acknowledgement is received (for **Emergency Alarm** only), **OR**
- All retries to send the alarm have been exhausted, **OR**
- The **Emergency Off** button is pressed.

**NOTE:** If your radio is powered off, it exits the Emergency mode. The radio will not reinitiate the Emergency mode automatically when it is turned on again.

## ■ Text Messaging Features

---

### Sending a Quick Text Message

You can send Quick Text messages, programmed by your dealer, via the programmable button.

#### Procedure:

- 1 Press the programmed **One Touch Access** button to send a predefined Quick Text message to a predefined ID.
- 2 The green LED lights up.
- 3 Two chirps indicate that the message is sent successfully.  
**OR**  
A low-pitch tone indicates that the message cannot be sent.

## ■ Privacy

---

If enabled, this feature helps to prevent eavesdropping by unauthorized users on a channel by the use of a software-based scrambling solution. The signaling and user identification portions of a transmission are not scrambled.

Your radio must have privacy enabled on the channel to send a privacy-enabled transmission, although this is not a necessary requirement for receiving a transmission. While on a privacy-enabled channel, the radio is still able to receive clear (unscrambled) transmissions.

Your radio supports two types of privacy:

- Basic Privacy
- Enhanced Privacy.

Only **ONE** of the privacy types above can be assigned to the radio.

To unscramble a privacy-enabled call or data transmission, your radio must be programmed to have the same Privacy Key (for Basic Privacy), OR the same Key Value and Key ID (for Enhanced Privacy) as the transmitting radio.

If your radio receives a scrambled call that is of a different Privacy Key, OR a different Key Value and Key ID, you will either hear a garbled transmission (Basic Privacy) or nothing at all (Enhanced Privacy).

The LED lights up solid green while the radio is transmitting and blinks green rapidly when the radio is receiving an ongoing privacy-enabled transmission.

**NOTE:** Some radio models may not offer this Privacy feature. Check with your dealer or system administrator for more information.

**Procedure:**

Press the programmed **Privacy** button to toggle privacy on or off.

## ■ Multi-Site Controls

---

These features are applicable when your current radio channel is part of an IP Site Connect or Linked Capacity Plus configuration.

See **IP Site Connect** on page 7 and **Linked Capacity Plus** on page 8 for more details about these configurations.

### Starting an Automatic Site Search

**NOTE:** The radio **only** scans for a new site if the current signal is weak or when the radio is unable to detect any signal from the current site. If the RSSI value is strong, the radio remains on the current site.

**Procedure:**

- 1 Press the programmed **Site Lock On/Off** button.
- 2 A tone sounds.
- 3 The yellow LED blinks rapidly when the radio is actively searching for a new site, and turns off once the radio locks on to a site.

*The radio also performs an automatic site search (site is unlocked) during a **PTT** button press or data transmission if the current channel, a multi-site channel with an attached roam list, is out of range.*

## Stopping an Automatic Site Search

When the radio is actively searching for a new site:

### Procedure:

- 1 Press the programmed **Site Lock On/Off** button.
- 2 A tone sounds and the LED turns off.

## Starting a Manual Site Search

### Procedure:

- 1 Press the programmed **Manual Site Roam** button.
- 2 A tone sounds and the green LED blinks.
- 3 You hear a positive indicator tone and the LED turns off, indicating the radio is locked on to a site.  
**OR**  
You hear a negative indicator tone and the LED turns off, indicating the radio is unable to lock on to a site.

## ■ Lone Worker

This feature prompts an emergency to be raised if there is no user activity, such as any radio button press or activation of the channel selector, for a predefined time.

Following no user activity for a programmed duration, the radio pre-warns the user via an audio indicator once the inactivity timer expires.

If there is still no acknowledgment by the user before the predefined reminder timer expires, the radio initiates an Emergency Alarm.

Only **one** of the following Emergency Alarms is assigned to this feature:

- Emergency Alarm
- Emergency Alarm with Call
- Emergency Alarm with Voice to Follow 

The radio remains in the emergency state allowing voice messages to proceed until action is taken. See **Emergency Operation** on page 23 on ways to exit Emergency.

This feature is limited to radios with this function enabled. Check with your dealer or system administrator for more information.

## ■ Password Lock Features

---

If enabled, this feature allows you to access your radio via password upon powering up.

### 📄 Accessing the Radio from Password

#### Procedure:

Power up the radio.

- 1 You hear a continuous tone.

---

  - 2 Press the Channel Rocker to select a digit and Front Button **P2** to enter the selected digit. Enter the remaining digits of the password in the same manner.

---

  - 3 When the last digit of the four-digit password is entered, your radio automatically checks the validity of the password. If the password is correct:  
Your radio proceeds to power up. See **Powering Up the Radio** on page 2.  
**OR**  
If the password is incorrect:  
You hear a continuous tone. Repeat Steps 1 and 2.  
**OR**  
After the third incorrect password, your radio enters into locked state. A tone sounds and the yellow LED double blinks.
- 

*Your radio enters into locked state for 15 minutes, and responds to inputs from **On/Off** button.*

**NOTE:** The radio is unable to receive any call, including emergency calls, in locked state.

The use of **Emergency** footswitch cancels out password input to access the radio.

### 📄 Unlocking the Radio from Locked State

#### Procedure:

Wait for 15 minutes. Repeat Steps 1 to 3 in **Accessing the Radio from Password** on page 30.

#### **OR**

Power up the radio, if you have powered down the radio during locked state:

- 1 A tone sounds and the yellow LED double blinks.

---

  - 2 Wait for 15 minutes. Repeat Steps 1 to 3 in **Accessing the Radio from Password** on page 30.
- 

*Your radio restarts the 15 minutes timer for locked state when you power up.*



## ■ Utilities

---

### **Setting the Squelch Level**

You can adjust your radio's squelch level to filter out unwanted calls with low signal strength or channels that have a higher than normal background noise.

**Settings:** **Normal** is the default. **Tight** filters out (unwanted) calls and/or background noise. However, calls from remote locations may also be filtered out.

#### **Procedure:**

- 1 Press the programmed **Squelch** button.

---

  - 2 You hear a positive indicator tone, indicating the radio is operating in tight squelch.  
**OR**  
You hear a negative indicator tone, indicating the radio is operating in normal squelch.
- 

### **Setting the Power Level**

You can customize your radio's power setting to high or low for each channel.

**Settings:** **High** enables communication with radios located at a considerable distance from you. **Low** enables communication with radios in closer proximity.

#### **Procedure:**

- 1 Press the programmed **Power Level** button.

---

  - 2 You hear a positive indicator tone, indicating the radio is transmitting at low power.  
**OR**  
You hear a negative indicator tone, indicating the radio is transmitting at high power.
- 

### **Turning the Option Board Feature(s) On or Off**

A channel can support up to 6 option board features. Refer to your dealer or system administrator for more information.

#### **Procedure:**

Press the programmed **Option Board Feature** button to toggle the feature on or off.

## Turning the Voice Operating Transmission (VOX) Feature On or Off

This feature allows you to initiate a hands-free voice activated call on a programmed channel. The radio automatically transmits, for a programmed period, whenever the microphone on the VOX-capable accessory detects voice.

**NOTE:** You may need to turn off the radio and power it up again after detaching the VOX-capable microphone to allow the radio to switch to another valid accessory.

Pressing the **PTT** button during radio operation will disable VOX. To re-enable VOX, do **one** of the following:

- Turn the radio off and power it on again, **OR**
- Change the channel via the Channel Rocker, **OR**
- Follow the procedure below.

**NOTE:** Turning this feature on or off is limited to radios with this function enabled. Check with your dealer or system administrator for more information.

### **Procedure:**

Press the programmed **VOX** button to toggle the feature on or off.

*If the Talk Permit Tone feature is enabled, use a trigger word to initiate the call. Wait for the Talk Permit Tone to finish before speaking clearly into the microphone.*

## Turning the Public Address System On or Off

You can enable and disable the radio's internal public address (PA) system.

### **Procedure:**

Press the programmed **PA On/Off** button to toggle the feature on or off.

## Turning the External Public Address System On or Off

You can enable or disable the audio routing between the connected public address (PA) loudspeaker amplifier and the radio's internal public address (PA) system.

### **Procedure:**

Press the programmed **Ext PA On/Off** button to toggle the feature on or off.

## Turning Horns/Lights On or Off

Your radio is able to notify you of an incoming call via the horns and lights feature. When activated, an incoming call sounds your vehicle's horn and turns on its lights.

This feature needs to be installed through your radio's rear accessory connector by your dealer.

### Procedure:

- 1 Press the programmed **Horns/Lights** button.

---

  - 2 You hear a positive indicator tone, indicating the horns and lights feature is on.  
**OR**  
You hear a negative indicator tone, indicating the horns and lights feature is off.
- 

## Turning Radio Tones/Alerts On or Off

You can enable and disable all radio tones and alerts (except for the incoming Emergency alert tone) if needed.

### Procedure:

- 1 Press the programmed **All Tones/Alerts** button.

---

  - 2 You hear a positive indicator tone, indicating all tones and alerts are on.  
**OR**  
You hear a negative indicator tone, indicating all tones and alerts are off.
-

## Accessories

Your radio is compatible with the accessories listed in this chapter. Contact your dealer for details.

Antennas . . . . .	page 34
Audio . . . . .	page 36
Cables . . . . .	page 36
Desktop Accessories . . . . .	page 36
Mounting Kits . . . . .	page 36
Remote Mount Adaptor Kits . . . . .	page 37
Speakers . . . . .	page 37
Miscellaneous Accessories . . . . .	page 37

### ■ Antennas

- VHF, 136 – 144 MHz, 1/4 Wave, Through-Hole Mount, Mini-U (HAD4006\_)
- VHF, 146 – 150.8 MHz, 1/4 Wave, Through-Hole Mount, Mini-U (HAD4007\_)
- VHF, 150.8 – 162 MHz, 1/4 Wave, Through-Hole Mount, Mini-U (HAD4008\_)
- VHF, 162 – 174 MHz, 1/4 Wave, Through-Hole Mount, Mini-U (HAD4009\_)
- VHF, 146 – 172 MHz, 3.0 dB Gain, Through-Hole Mount, Mini-U (HAD4014\_)

- UHF, 403 – 430 MHz, 1/4 Wave, Through-Hole Mount, Mini-U (HAE4002\_)
- UHF, 450 – 470 MHz, 1/4 Wave, Through-Hole Mount, Mini-U (HAE4003\_)
- UHF, 470 – 527 MHz, 1/4 Wave, Through-Hole Mount, Mini-U (HAE4004\_)
- UHF, 406 – 420 MHz, 3.5 dB Gain, Through-Hole Mount, Mini-U (HAE4010\_)
- UHF, 450 – 470 MHz, 3.5 dB Gain, Through-Hole Mount, Mini-U (HAE4011\_)
- UHF, 470 – 494 MHz, 3.5 dB Gain, Through-Hole Mount, Mini-U (HAE4012\_)
- UHF, 494 – 512 MHz, 3.5 dB Gain, Through-Hole Mount, Mini-U (HAE4013\_)
- UHF, 403 – 527 MHz, 2.0 dB Gain, Through-Hole Mount, Mini-U (HAE6022\_)
- Combination GPS+RF, 806 – 941 MHz, 1/4 Wave, Through-Hole Mount, Mini-U (HAF4029\_)
- Combination GPS+RF, 806 – 941 MHz, 3.0 dB Gain, Through-Hole Mount, Mini-U (HAF4030\_)
- Combination GPS+RF, 806 – 941 MHz, 5.0 dB Gain, Through-Hole Mount, Mini-U (HAF4032\_)
- Combination GPS+RF, 806 – 941 MHz, 5.0 dB Gain, Through-Hole Mount, Mini-U (HAF4033\_)

- UHF, 450 – 470 MHz, 5.0 dB Gain, Through-Hole Mount, Mini-U (RAE4004\_)UHF, 350 – 375 MHz, 4.5 dB Gain, Through-Hole Mount, BNC (PMAD4108\_)UHF, 350 – 375 MHz, Stubby, Through-Hole Mount, BNC (PMAD4110\_)UHF, 350 – 400 MHz, 1/4 Wave, Through-Hole Mount, BNC (PMAD4107\_)UHF, 350 – 400 MHz, 2.0 dB Gain, Through-Hole Mount, BNC (PMAD4109\_)UHF, 375 – 400 MHz, Stubby Through-Hole Mount, BNC (PMAD4111\_)UHF, 375 – 400 MHz, 4.5 dB Gain, Through-Hole Mount, BNC (PMAD4113\_)Combination GPS/VHF, 136 – 144 MHz, 1/4 Wave, Through-Hole Mount, Mini-U (RAD4214\_)
- Combination GPS/VHF, 146 – 150.8 MHz, 1/4 Wave, Through-Hole Mount, Mini-U (RAD4215\_)
- Combination GPS/VHF, 150.8 – 162 MHz, 1/4 Wave, Through-Hole Mount, Mini-U (RAD4216\_)
- Combination GPS/VHF, 162 – 174 MHz, 1/4 Wave, Through-Hole Mount, Mini-U (RAD4217\_)
- Combination GPS/VHF, 146 – 172 MHz, 3.0 dB Gain, Through-Hole Mount, Mini-U (RAD4218\_)
- Combination GPS/UHF, 403 – 527 MHz, 2.0 dB Gain, Through-Hole Mount, Mini-U (HAE6019\_)
- Combination GPS/UHF, 470 – 527 MHz, 1/4 Wave, Through-Hole Mount, Mini-U (HAE6020\_)
- Combination GPS/UHF, 470 – 494 MHz, 3.0 dB Gain, Through-Hole Mount, Mini-U (HAE6024\_)
- Combination GPS/UHF, 494 – 512 MHz, 3.0 dB Gain, Through-Hole Mount, Mini-U (HAE6026\_)
- Combination GPS/UHF, 403 – 430 MHz, 1/4 Wave, Through-Hole Mount, Mini-U (PMAE4030\_)Combination GPS/UHF, 450 – 470 MHz, 1/4 Wave, Through-Hole Mount, Mini-U (PMAE4031\_)
- Combination GPS/UHF, 406 – 420 MHz, 3.5 dB Gain, Through-Hole Mount, Mini-U (PMAE4032\_)
- Combination GPS/UHF, 450 – 470 MHz, 3.5 dB Gain, Through-Hole Mount, Mini-U (PMAE4033\_)
- Combination GPS/UHF, 450 – 470 MHz, 5.0 dB Gain, Through-Hole Mount, Mini-U (PMAE4034\_)
- Combination GPS/UHF, 350 – 375 MHz, 4.5 dB Gain, Through-Hole Mount, BNC (PMAD4106\_)
- Combination GPS/UHF, 350 – 400 MHz, 1/4 Wave, Through-Hole Mount, BNC (PMAD4102\_)
- Combination GPS/UHF, 350 – 400 MHz, Stubby, Through-Hole Mount, BNC (PMAD4103\_)
- Combination GPS/UHF, 350 – 400 MHz, 2.0 dB Gain, Through-Hole Mount, BNC (PMAD4105\_)
- Combination GPS/UHF, 375 – 400 MHz, 4.5 dB Gain, Through-Hole Mount, BNC (PMAD4104\_)
- Fixed Mount GPS Active Antenna (PMAN4000\_)
- Window Mount GPS Active Antenna (PMAN4001\_)
- Magnetic Mount GPS Active Antenna (PMAN4002\_)

## ■ Audio

---

- Telephone Style Handset (HMN4098\_)
- Desktop Microphone (RMN5050\_)
- Compact Microphone (RMN5052\_)
- Heavy Duty Microphone with Enhanced Audio (RMN5053\_)
- Visor Microphone with Enhanced Audio (RMN5054\_)

## ■ Cables

---

- Power Cable to Battery, 10-foot (3-metre) Cable, 15 amp (1 – 25 Watt) (HKN4137\_)
- Power Cable to Battery, 10-foot (3-metre) Cable, 20 amp (1 – 45 Watt) (HKN4191\_)
- Power Cable to Battery, 20-foot (6-metre) Cable, 20 amp (1 – 45 Watt) (HKN4192\_)
- Mobile and Repeater Rear Accessory Connector Universal Cable (PMKN4018\_)
- Ignition Sense Cable (RKN4136\_)

## ■ Desktop Accessories

---

- Radio Power Cable for GPN6145 (GKN6266\_)
- Desktop Tray without Speaker (GLN7318\_)
- Desktop Tray with Speaker (RSN4005\_)
- Switchmode Power Supply (1 – 25 Watt Models) (CE marked) (GPN6145\_)
- Mobile Mini-U Antenna Adapter, 8-foot (2.4-metre) Cable (HKN9088\_)
- Power Supply and Cable (HPN4007\_)
- Hardware Kit for Rear Accessory Connector (PMLN5072\_)

## ■ Mounting Kits

---

- In Dash (DIN) Mounting Kit (RLN5933\_)
- Low Profile Trunnion Kit (RLN6077\_)
- High Profile Trunnion Kit (RLN6078\_)
- Key Lock Trunnion Kit (RLN6079\_)

## ■ Remote Mount Adaptor Kits

---

- Mobile Remote Mount 5-Meter Cable Kit (PMKN4073\_)
- Mobile Remote Mount 3-Meter Cable Kit (PMKN4074\_)
- Mobile Remote Mount Adaptor Kit (PMLN5404\_)

## ■ Speakers

---

- 13-Watt External Speaker (RSN4002\_)
- 7.5-Watt External Speaker (RSN4003\_)
- 5-Watt External Speaker (RSN4004\_)

## ■ Miscellaneous Accessories

---

- Mobile Button Kit (Includes Buttons for Remote Monitor, Radio Check, Radio Disable, and VOX) (HKLN4292\_)
- Numeric Display Mobile Button Kit (Includes Buttons for Monitor and Scan) (HKLN4293\_)
- PL259/Mini-U Antenna Adapter, 8-foot (2.4-metre) Cable (HKN9557\_)
- Microphone Hang Up Clip (All Microphones) (HLN9073\_)
- Universal Microphone Hang Up Clip (All Microphones) (HLN9414\_)
- Push Button PTT (RLN5926\_)
- Emergency Footswitch (RLN5929\_)

## Appendix: Maritime Radio Use in the VHF Frequency Range

Take a moment to review the following:

Special Channel Assignments . . . . . page 38

Operating Frequency Requirements . . . . . page 39

### ■ Special Channel Assignments

#### 📄 Emergency Channel

If you are in imminent and grave danger at sea and require emergency assistance, use **VHF Channel 16** to send a distress call to nearby vessels and the United States Coast Guard.

Transmit the following information, in this order:

- 1 "MAYDAY, MAYDAY, MAYDAY."
- 2 "THIS IS \_\_\_\_\_, CALL SIGN \_\_\_\_\_."  
State the name of the vessel in distress 3 times, followed by the call sign or other identification of the vessel, stated 3 times.
- 3 Repeat "MAYDAY" and the name of the vessel.

- 4 "WE ARE LOCATED AT \_\_\_\_\_."  
State the position of the vessel in distress, using any information that will help responders to locate you, e.g.:
  - latitude and longitude
  - bearing (state whether you are using true or magnetic north)
  - distance to a well-known landmark
  - vessel course, speed or destination
- 5 State the nature of the distress.
- 6 Specify what kind of assistance you need.
- 7 State the number of persons on board and the number needing medical attention, if any.
- 8 Mention any other information that would be helpful to responders, such as type of vessel, vessel length and/or tonnage, hull color, etc.
- 9 "OVER."
- 10 Wait for a response.
- 11 If you do not receive an immediate response, remain by the radio and repeat the transmission at intervals until you receive a response. Be prepared to follow any instructions given to you.

#### 📄 Non-Commercial Call Channel

For non-commercial transmissions, such as fishing reports, rendezvous arrangements, repair scheduling, or berthing information, use **VHF Channel 9**.



## ■ Operating Frequency Requirements

A radio designated for shipboard use must comply with Federal Communications Commission Rule Part 80 as follows:

- on ships subject to Part II of Title III of the Communications Act, the radio must be capable of operating on the 156.800 MHz frequency
- on ships subject to the Safety Convention, the radio must be capable of operating:
  - in the simplex mode on the ship station transmitting frequencies specified in the 156.025 – 157.425 MHz frequency band, and
  - in the semiduplex mode on the two frequency channels specified in the table below.

**NOTE:** Simplex channels 3, 21, 23, 61, 64, 81, 82, and 83 cannot be lawfully used by the general public in US waters.

Additional information about operating requirements in the Maritime Services can be obtained from the full text of FCC Rule Part 80 and from the US Coast Guard.

**Table A-1: VHF Marine Channel List**

Channel Number	Frequency (MHz)	
	Transmit	Receive
1	156.050	160.650

**Table A-1: VHF Marine Channel List (Continued)**

Channel Number	Frequency (MHz)	
	Transmit	Receive
2	156.100	160.700
*	156.150	160.750
4	156.200	160.800
5	156.250	160.850
6	156.300	–
7	156.350	160.950
8	156.400	–
9	156.450	156.450
10	156.500	156.500
11	156.550	156.550
12	156.600	156.600
13**	156.650	156.650
14	156.700	156.700
15**	156.750	156.750
16	156.800	156.800
17**	156.850	156.850
18	156.900	161.500
19	156.950	161.550
20	157.000	161.600
*	157.050	161.650
22	157.100	161.700
*	157.150	161.750

Table A-1: VHF Marine Channel List (Continued)

Channel Number	Frequency (MHz)	
	Transmit	Receive
24	157.200	161.800
25	157.250	161.850
26	157.300	161.900
27	157.350	161.950
28	157.400	162.000
60	156.025	160.625
*	156.075	160.675
62	156.125	160.725
63	156.175	160.775
*	156.225	160.825
65	156.275	160.875
66	156.325	160.925
67**	156.375	156.375
68	156.425	156.425
69	156.475	156.475
71	156.575	156.575
72	156.625	—
73	156.675	156.675
74	156.725	156.725
75	***	***
76	***	***
77**	156.875	—

Table A-1: VHF Marine Channel List (Continued)

Channel Number	Frequency (MHz)	
	Transmit	Receive
78	156.925	161.525
79	156.975	161.575
80	157.025	161.625
*	157.075	161.675
*	157.125	161.725
*	157.175	161.775
84	157.225	161.825
85	157.275	161.875
86	157.325	161.925
87	157.375	161.975
88	157.425	162.025

\* Simplex channels 3, 21, 23, 61, 64, 81, 82, and 83 cannot be **lawfully used** by the general public in US waters.

\*\* Low power (1 W) only

\*\*\* Guard band

**NOTE:** A – in the Receive column indicates that the channel is transmit only.

# Limited Warranty

## MOTOROLA COMMUNICATION PRODUCTS

### I. WHAT THIS WARRANTY COVERS AND FOR HOW LONG:

MOTOROLA SOLUTIONS, INC. ("MOTOROLA") warrants the MOTOROLA manufactured Communication Products listed below ("Product") against defects in material and workmanship under normal use and service for a period of time from the date of purchase as scheduled below:

XPR Series Digital Mobile Radios	Two (2) Years
Product Accessories	One (1) Year

MOTOROLA, at its option, will at no charge either repair the Product (with new or reconditioned parts), replace it (with a new or reconditioned Product), or refund the purchase price of the Product during the warranty period provided it is returned in accordance with the terms of this warranty. Replaced parts or boards are warranted for the balance of the original applicable warranty period. All replaced parts of Product shall become the property of MOTOROLA.

This express limited warranty is extended by MOTOROLA to the original end user purchaser only and is not assignable or transferable to any other party. This is the complete warranty for the Product manufactured by MOTOROLA. MOTOROLA assumes no

obligations or liability for additions or modifications to this warranty unless made in writing and signed by an officer of MOTOROLA.

Unless made in a separate agreement between MOTOROLA and the original end user purchaser, MOTOROLA does not warrant the installation, maintenance or service of the Product.

MOTOROLA cannot be responsible in any way for any ancillary equipment not furnished by MOTOROLA which is attached to or used in connection with the Product, or for operation of the Product with any ancillary equipment, and all such equipment is expressly excluded from this warranty. Because each system which may use the Product is unique, MOTOROLA disclaims liability for range, coverage, or operation of the system as a whole under this warranty.

### II. GENERAL PROVISIONS:

This warranty sets forth the full extent of MOTOROLA'S responsibilities regarding the Product. Repair, replacement or refund of the purchase price, at MOTOROLA'S option, is the exclusive remedy. THIS WARRANTY IS GIVEN IN LIEU OF ALL OTHER EXPRESS WARRANTIES. IMPLIED WARRANTIES, INCLUDING WITHOUT LIMITATION, IMPLIED WARRANTIES OF MERCHANTABILITY AND FITNESS FOR A PARTICULAR PURPOSE, ARE LIMITED TO THE DURATION OF THIS LIMITED WARRANTY. IN NO EVENT SHALL MOTOROLA BE LIABLE FOR DAMAGES IN EXCESS OF THE PURCHASE PRICE OF THE PRODUCT, FOR ANY LOSS OF USE, LOSS OF TIME, INCONVENIENCE, COMMERCIAL LOSS, LOST PROFITS OR SAVINGS OR OTHER INCIDENTAL, SPECIAL OR CONSEQUENTIAL DAMAGES ARISING OUT OF THE USE OR

INABILITY TO USE SUCH PRODUCT, TO THE FULL EXTENT SUCH MAY BE DISCLAIMED BY LAW.

### III. STATE LAW RIGHTS:

SOME STATES DO NOT ALLOW THE EXCLUSION OR LIMITATION OF INCIDENTAL OR CONSEQUENTIAL DAMAGES OR LIMITATION ON HOW LONG AN IMPLIED WARRANTY LASTS, SO THE ABOVE LIMITATION OR EXCLUSIONS MAY NOT APPLY.

This warranty gives specific legal rights, and there may be other rights which may vary from state to state.

### IV. HOW TO GET WARRANTY SERVICE:

You must provide proof of purchase (bearing the date of purchase and Product item serial number) in order to receive warranty service and, also, deliver or send the Product item, transportation and insurance prepaid, to an authorized warranty service location. Warranty service will be provided by MOTOROLA through one of its authorized warranty service locations. If you first contact the company which sold you the Product (e.g., dealer or communication service provider), it can facilitate your obtaining warranty service. You can also call MOTOROLA at 1-800-927-2744 US/Canada.

### V. WHAT THIS WARRANTY DOES NOT COVER:

- A) Defects or damage resulting from use of the Product in other than its normal and customary manner.
- B) Defects or damage from misuse, accident, water, or neglect.

- C) Defects or damage from improper testing, operation, maintenance, installation, alteration, modification, or adjustment.
- D) Breakage or damage to antennas unless caused directly by defects in material workmanship.
- E) A Product subjected to unauthorized Product modifications, disassembles or repairs (including, without limitation, the addition to the Product of non-MOTOROLA supplied equipment) which adversely affect performance of the Product or interfere with MOTOROLA's normal warranty inspection and testing of the Product to verify any warranty claim.
- F) Product which has had the serial number removed or made illegible.
- G) Rechargeable batteries if:
  - (1) any of the seals on the battery enclosure of cells are broken or show evidence of tampering.
  - (2) the damage or defect is caused by charging or using the battery in equipment or service other than the Product for which it is specified.
- H) Freight costs to the repair depot.
- I) A Product which, due to illegal or unauthorized alteration of the software/firmware in the Product, does not function in accordance with MOTOROLA's published specifications or the FCC certification labeling in effect for the Product at the time the Product was initially distributed from MOTOROLA.
- J) Scratches or other cosmetic damage to Product surfaces that does not affect the operation of the Product.
- K) Normal and customary wear and tear.

## VI. PATENT AND SOFTWARE PROVISIONS:

MOTOROLA will defend, at its own expense, any suit brought against the end user purchaser to the extent that it is based on a claim that the Product or parts infringe a United States patent, and MOTOROLA will pay those costs and damages finally awarded against the end user purchaser in any such suit which are attributable to any such claim, but such defense and payments are conditioned on the following:

- A) that MOTOROLA will be notified promptly in writing by such purchaser of any notice of such claim;
- B) that MOTOROLA will have sole control of the defense of such suit and all negotiations for its settlement or compromise; and
- C) should the Product or parts become, or in MOTOROLA's opinion be likely to become, the subject of a claim of infringement of a United States patent, that such purchaser will permit MOTOROLA, at its option and expense, either to procure for such purchaser the right to continue using the Product or parts or to replace or modify the same so that it becomes non-infringing or to grant such purchaser a credit for the Product or parts as depreciated and accept its return. The depreciation will be an equal amount per year over the lifetime of the Product or parts as established by MOTOROLA.

MOTOROLA will have no liability with respect to any claim of patent infringement which is based upon the combination of the Product or parts furnished hereunder with software, apparatus or devices not furnished by MOTOROLA, nor will MOTOROLA have any liability for the use of ancillary equipment or software not furnished by MOTOROLA which is attached to or used in connection with the Product. The foregoing states the entire liability of MOTOROLA with respect to infringement of patents by the Product or any parts thereof.

Laws in the United States and other countries preserve for MOTOROLA certain exclusive rights for copyrighted MOTOROLA software such as the exclusive rights to reproduce in copies and distribute copies of such MOTOROLA software. MOTOROLA software may be used in only the Product in which the software was originally embodied and such software in such Product may not be replaced, copied, distributed, modified in any way, or used to produce any derivative thereof. No other use including, without limitation, alteration, modification, reproduction, distribution, or reverse engineering of such MOTOROLA software or exercise of rights in such MOTOROLA software is permitted. No license is granted by implication, estoppel or otherwise under MOTOROLA patent rights or copyrights.

## VII. GOVERNING LAW:

This Warranty is governed by the laws of the State of Illinois, U.S.A.



Motorola Solutions, Inc.  
1303 East Algonquin Road  
Schaumburg, Illinois 60196 U.S.A.

MOTOROLA, MOTO, MOTOROLA SOLUTIONS and  
the Stylized M logo are trademarks or registered trademarks  
of Motorola Trademark Holdings, LLC and are used under license.  
All other trademarks are the property of their respective owners.  
© 2006 – 2012 Motorola Solutions, Inc. All rights reserved.  
February 2012.

[www.motorolasolutions.com/mototrbo](http://www.motorolasolutions.com/mototrbo)



**6880309T18-L**