

APX™ Two-Way Radios

Model 4.5

APX N70 User Guide

APRIL 2024

© 2024 Motorola Solutions, Inc. All Rights Reserved.



MN009207A01-AE

Contents

List of Figures	8
List of Tables	9
Legal and Support	10
Intellectual Property and Regulatory Notices.....	10
Legal and Compliance Statements.....	11
Disclaimer.....	11
Declaration of Conformity.....	11
Notice to Users (FCC).....	12
FCC Licensing Information.....	12
Applying for Canadian License.....	13
Important Safety Information.....	13
Limited Warranty.....	14
MOTOROLA SOLUTIONS COMMUNICATION PRODUCTS.....	14
I. WHAT THIS WARRANTY COVERS AND FOR HOW LONG:.....	14
II. GENERAL PROVISIONS:.....	15
III. STATE LAW RIGHTS:.....	15
IV. HOW TO GET WARRANTY SERVICE:.....	15
V. WHAT THIS WARRANTY DOES NOT COVER:.....	15
VI. PATENT AND SOFTWARE PROVISIONS:.....	16
VII. GOVERNING LAW:.....	16
VIII. For Australia Only.....	16
Read Me First	18
Software Version.....	18
Touchscreen Navigation.....	19
Chapter 1: Radio Care	21
1.1 Cleaning Your Radio.....	22
1.2 Radio Service and Repair.....	22
1.3 Battery Recycling and Disposal.....	22
Chapter 2: Radio Overview	23
2.1 Programmable Radio Functions.....	25
2.2 ViQi.....	27
2.2.1 Using ViQi.....	30
Chapter 3: Getting Started	32
3.1 Attaching and Removing the Battery.....	32
Attaching the Battery.....	32

Removing the Battery.....	32
3.2 Attaching and Removing the Antenna.....	32
Attaching the Antenna.....	32
Removing the Antenna.....	32
3.3 Inserting or Removing the SIM Card.....	33
3.4 Attaching and Removing the Accessory Connector Cover.....	33
Attaching the Accessory Connector Cover.....	33
Removing the Accessory Connector Cover.....	33
3.5 Using the Carry Holder.....	33
3.6 Charging the Radio.....	34
3.7 Turning the Radio On or Off.....	34
Turning the Radio On.....	34
Turning the Radio Off.....	34
3.8 Adjusting the Volume of the Radio.....	34
3.9 Adjusting the Display Brightness.....	35
3.10 Turning On Night Mode.....	35
3.11 Setting the Clock.....	35
3.12 Setting the Front Display Timer.....	35
Chapter 4: Home Screen Overview.....	36
4.1 On-Screen Keyboard Overview.....	37
4.2 Identity and Status Widget.....	38
4.2.1 Managing Operational Status.....	38
4.2.2 User Login Feature.....	39
4.2.2.1 Logging In to Automatic Registration Service.....	39
4.2.2.2 Logging Out of Automatic Registration Service.....	39
4.2.3 Entering the Soft ID.....	39
4.2.4 CommandCentral Authentication Login.....	40
4.2.4.1 Logging In to CommandCentral.....	40
4.2.4.2 Logging Off CommandCentral.....	41
4.2.5 Updating Unit ID.....	41
4.2.6 Updating On/Off Duty Status.....	41
4.3 Status Indicators.....	42
4.3.1 Radio Icons.....	42
4.3.2 LED Indications.....	44
4.3.3 Transmit and Receive Indicator.....	45
Chapter 5: General Radio Operation.....	47
5.1 Responding to Notifications.....	47
5.2 Managing Mode Select Menus.....	47
5.3 Toggling the Controls and Buttons Tones On and Off.....	48

5.4 Control Lock.....	48
5.4.1 Locking the Controls.....	48
5.5 Toggling the Transmit Power Level between High and Low.....	48
5.6 Selecting a Radio Profile.....	49
5.7 General Radio Information.....	49
5.7.1 Accessing the General Radio Information.....	50
Chapter 6: Zone and Channel Selection.....	51
6.1 Selecting Zones.....	51
6.2 Selecting Zones from Zone Banks.....	51
6.3 Selecting Channels.....	52
6.3.1 Channel Error Messages.....	52
Chapter 7: Dynamic Zone Programming.....	53
7.1 Selecting Channels in the Dynamic Zone.....	53
7.2 Managing Channels in the Dynamic Zone.....	53
Chapter 8: Zone-to-Zone Cloning.....	55
8.1 Cloning Zones.....	55
Chapter 9: Multiple Private Line.....	56
9.1 Selecting Multiple Private Line.....	56
Chapter 10: Types of Radio Calls.....	57
10.1 Making Calls on the Radio.....	58
10.2 Receiving Calls on the Radio.....	59
10.3 Making Priority Dispatch Calls.....	59
Chapter 11: Emergency Operation.....	61
11.1 Special Considerations for Emergency Operation.....	61
11.2 Sending Emergency Alarms.....	62
11.3 Sending Emergency Alarms with Emergency Calls.....	62
11.4 Exiting Emergency Operation.....	63
11.5 Remote Emergency.....	64
11.5.1 Sending Remote Emergency from Contacts.....	64
11.5.2 Sending Remote Emergency from the Dialer.....	64
11.5.3 Sending Remote Emergency from Menu Feature Launcher.....	65
11.5.4 Receiving Remote Emergency.....	65
11.6 Emergency Keep-Alive.....	66
11.7 Emergency Beacon.....	66
11.7.1 Sending Emergency Beacons.....	66
11.7.2 Receiving Emergency Beacons.....	66
11.7.3 Viewing Received Emergency Beacon.....	67
Chapter 12: Fireground.....	68

12.1 Entering Fireground Zone Channel (Conventional).....	68
12.2 Responding to Evacuation Indicator.....	69
12.3 Sending Evacuation Tone.....	69
Chapter 13: Tactical Public Safety (Conventional Only).....	70
13.1 Using TPS Normal Transmission.....	70
13.2 Using TPS Emergency Transmission.....	70
Chapter 14: Fall Alert	71
14.1 Radio Alerts When Fall Alert is Triggered.....	71
14.2 Testing Fall Alert.....	71
14.3 Exiting Fall Alert.....	72
14.4 Reinitiating Fall Alert.....	72
Chapter 15: Secure Operations.....	73
15.1 Toggling Between Secure and Clear Transmission.....	73
15.2 Multikey Feature.....	73
15.3 MDC OTAR (Conventional Only).....	73
15.4 Selecting Encryption Keys (Conventional Only).....	74
15.5 Changing Encryption Keysets.....	74
15.6 Infinite UKEK Retention.....	74
15.7 Requesting Rekey.....	74
Chapter 16: Scan.....	75
16.1 Toggling the Scan Feature On and Off.....	75
16.2 Making a Dynamic Priority Change (Conventional Scan Only).....	75
16.3 Deleting Nuisance Channels.....	75
16.4 Restoring a Nuisance Channel.....	76
Chapter 17: Scan Lists.....	77
17.1 Intelligent Priority Scan.....	77
17.2 Managing the Scan List.....	77
Chapter 18: SmartProgramming.....	78
18.1 Programming using USB for CPS.....	78
18.2 Firmware Update Notification Actions.....	79
Chapter 19: Over-The-Air Programming (POP 25).....	80
19.1 Responding to Codeplug Update Notification.....	80
Chapter 20: Connectivity.....	81
20.1 LTE.....	81
20.1.1 Editing APN Configuration.....	81
20.2 SmartConnect.....	81
20.3 Wi-Fi.....	82
20.4 Bluetooth®.....	82

20.4.1	Toggling Bluetooth On and Off	82
20.4.2	Searching and Pairing the Bluetooth Device.....	82
20.4.3	Toggling Bluetooth Audio On and Off.....	83
20.4.4	Viewing and Clearing the Bluetooth Enabled Device Information.....	83
20.5	P25 Digital Vehicular Repeater System.....	83
20.6	Sideloaded Files on the Radio Using USB Cable.....	84
Chapter 21:	Location.....	85
21.1	Toggling Location On and Off.....	85
21.2	Viewing My Location.....	85
21.3	Waypoints.....	86
21.3.1	Managing Waypoints.....	86
21.4	SmartMapping.....	87
21.4.1	Viewing Units/Devices.....	88
21.4.2	Creating Waypoints in Map View.....	89
21.4.3	Editing Waypoints in Map View.....	89
21.4.4	Managing Options in Map View.....	89
21.4.5	Managing Options in List View.....	90
Chapter 22:	Mission Critical Geofence (ASTRO 25 Trunking).....	91
22.1	Entry to the Geofence Area.....	91
22.2	Entry to Mission Critical Geofence.....	92
22.3	Exit from Mission Critical Geofence.....	92
Chapter 23:	Contacts.....	93
23.1	Contacts Overview.....	93
23.2	Accessing Contacts.....	95
Chapter 24:	Recent Calls.....	96
24.1	Viewing Recent Calls.....	96
24.2	Deleting Calls.....	96
24.3	Accessing Instant Recall.....	97
Chapter 25:	SmartMessaging.....	98
25.1	User Presence.....	98
25.2	Sending Quick Text Messages.....	98
25.3	Viewing Messages.....	99
25.4	Replying Messages.....	99
25.5	Deleting Messages.....	99
25.6	Accessing Multimedia Attachments.....	100
Chapter 26:	Messages.....	102
26.1	Creating New Messages.....	102
26.2	Viewing Messages.....	102

26.3 Deleting Messages.....	102
Chapter 27: Voice Announcement	104
Chapter 28: Radio Inhibit.....	105
Chapter 29: Smart PTT (Conventional Only).....	106
Chapter 30: Remote Monitor.....	107
Chapter 31: Toggling between Repeater and Direct Operation.....	108
Chapter 32: Trunking System Controls	109
32.1 Operating in Failsoft System.....	109
32.2 Imbalanced Coverage.....	109
32.3 Out-of-Range Radio.....	109
32.4 Site Trunking Feature.....	109
32.5 Site Search.....	110
Chapter 33: Dynamic Regrouping (Trunking Only)	111
33.1 Classification of Regrouped Radios.....	111
33.2 Requesting a Reprogram.....	111
Chapter 34: Front Panel Programming.....	112
34.1 Initiating the FPP Feature.....	112
34.2 Changing PIN (Optional).....	112
34.3 Editing FPP Mode Parameters.....	113
Chapter 35: Accessories.....	114

List of Figures

Figure 1: Radio Overview.....	23
Figure 2: Home Screen Overview.....	36
Figure 3: On-Screen Keyboard Overview.....	38
Figure 4: Firmware Update Notification.....	79
Figure 5: Contacts Tab.....	93
Figure 6: Call List Tab.....	94

List of Tables

Table 1: Touchscreen Actions.....	19
Table 2: Radio Overview Description.....	23
Table 3: Assignable Radio Functions.....	25
Table 4: ViQi Voice Control Commands.....	27
Table 5: ViQi Virtual Partner Queries.....	29
Table 6: Home Screen Overview Description.....	36
Table 7: LED Indications.....	45
Table 8: MPL Selection Mode.....	56
Table 9: Emergency Operation Scenarios.....	61
Table 10: SmartMapping Icons.....	87
Table 11: Contacts Tab.....	94
Table 12: Call List Tab.....	95
Table 13: User Status Icons.....	98

Legal and Support

Intellectual Property and Regulatory Notices

Copyrights

The Motorola Solutions products described in this document may include copyrighted Motorola Solutions computer programs. Laws in the United States and other countries preserve for Motorola Solutions certain exclusive rights for copyrighted computer programs. Accordingly, any copyrighted Motorola Solutions computer programs contained in the Motorola Solutions products described in this document may not be copied or reproduced in any manner without the express written permission of Motorola Solutions.

No part of this document may be reproduced, transmitted, stored in a retrieval system, or translated into any language or computer language, in any form or by any means, without the prior written permission of Motorola Solutions, Inc.

Trademarks

MOTOROLA, MOTO, MOTOROLA SOLUTIONS, and the Stylized M Logo are trademarks or registered trademarks of Motorola Trademark Holdings, LLC and are used under license. All other trademarks are the property of their respective owners.

License Rights

The purchase of Motorola Solutions products shall not be deemed to grant either directly or by implication, estoppel or otherwise, any license under the copyrights, patents or patent applications of Motorola Solutions, except for the normal nonexclusive, royalty-free license to use that arises by operation of law in the sale of a product.

Open Source Content

This product may contain Open Source software used under license. Refer to the product installation media for full Open Source Legal Notices and Attribution content.

European Union (EU) and United Kingdom (UK) Waste of Electrical and Electronic Equipment (WEEE) Directive



The European Union's WEEE directive and the UK's WEEE regulation require that products sold into EU countries and the UK must have the crossed-out wheellie bin label on the product (or the package in some cases). As defined by the WEEE directive, this crossed-out wheellie bin label means that customers and end users in EU and UK countries should not dispose of electronic and electrical equipment or accessories in household waste.

Customers or end users in EU and UK countries should contact their local equipment supplier representative or service center for information about the waste collection system in their country.

Disclaimer

Please note that certain features, facilities, and capabilities described in this document may not be applicable to or licensed for use on a specific system, or may be dependent upon the characteristics of a specific mobile subscriber unit or configuration of certain parameters. Please refer to your Motorola Solutions contact for further information.

© 2024 Motorola Solutions, Inc. All Rights Reserved

Legal and Compliance Statements

Disclaimer

The information in this document is carefully examined, and is believed to be entirely reliable. However, no responsibility is assumed for inaccuracies.

Furthermore, Motorola Solutions reserves the right to change any products to improve readability, function, or design. Motorola Solutions does not assume any liability arising out of the applications or use of any product or circuit described herein; nor does it cover any license under its patent rights, nor the rights of others.

Declaration of Conformity

Per FCC CFR 47 Part 2 Section 2.1077(a)



Responsible Party

Name: Motorola Solutions, Inc.

Address: 2000 Progress Pkwy, Schaumburg, IL 60196-1078, U.S.A.

Phone Number: 1-800-927-2744

Hereby declares that the product:

Model Name: **APX N70**

conforms to the following regulations:

FCC Part 15, subpart B, section 15.107(a), 15.107(d), and section 15.109(a)

Class B Digital Device

As a personal computer peripheral, this device complies with Part 15 of the FCC Rules. Operation is subject to the following two conditions:

1. This device may not cause harmful interference, and

2. This device must accept any interference received, including interference that may cause undesired operation.



NOTE:

This equipment has been tested and found to comply with the limits for a Class B digital device, pursuant to part 15 of the FCC Rules. These limits are designed to provide reasonable protection against harmful interference in a residential installation. This equipment generates, uses, and can radiate radio frequency energy and, if not installed and used in accordance with the instructions, may cause harmful interference to radio communications. However, there is no guarantee that interference will not occur in a particular installation.

If this equipment does cause harmful interference to radio or television reception, which can be determined by turning the equipment off and on, the user is encouraged to try to correct the interference by one or more of the following measures:

- Reorient or relocate the receiving antenna.
- Increase the separation between the equipment and receiver.
- Connect the equipment into an outlet on a circuit different from that to which the receiver is connected.
- Consult the dealer or an experienced radio or TV technician for help.

For country code selection usage (WLAN devices)



NOTE: The country code selection is for non-US model only and is not available to all US models. Per FCC regulation, all Wi-Fi products marketed in the US must be fixed to US operation channels only.

Notice to Users (FCC)

This device complies with Part 15 of the FCC rules per the following conditions:

- This device may not cause harmful interference.
- The device must accept any interference received, including interference that may cause undesired operation.
- Changes or modifications made to this device, not expressly approved by Motorola Solutions, could void the authority of the user to operate this equipment.

FCC Licensing Information

This device complies with Parts 90 and 15 of the Federal Communications Commission (FCC) Rules.

Operation is subject to the condition that this device does not cause harmful interference. The radio operates on radio frequencies that are regulated by the Federal Communications Commission (FCC). To transmit on these frequencies, you are required to have a license issued by the FCC. Application is made available on FCC Form 601 and Schedules D, H, and Remittance Form 159.

To obtain these FCC forms, request document 000601 which includes all forms and instructions. If you wish to have the document faxed, mailed, or have questions, use the following contact information.

Fax

Contact the Fax-On-Demand system at 1-202-418-0177

Mail

Call the FCC forms hotline at 1-800-418-FORM or 1-800-418-3676

Contact

For questions regarding FCC license, contact 1-888-CALL-FCC, 1-888-225-5322, or <http://www.fcc.gov>.

Before filling out your application, you must decide which frequency you can operate on. For questions on determining the radio frequency, call Motorola Solutions Product Services at: 1-800-448- 6686. Changes

or modifications not expressly approved by Motorola Solutions may void the user authority granted by the FCC to operate this radio and should not be made. To comply with FCC requirements, transmitter adjustments should be made only by or under the supervision of a person certified as technically qualified to perform transmitter maintenance and repairs in the private land mobile and fixed services as certified by an organization representative of the user of those services.

Replacement of any transmitter component such as crystal, semiconductor, and others not authorized by the FCC equipment authorization for this radio could violate FCC rules.



NOTE: Use of this radio outside the country where it was intended to be distributed is subject to government regulations and may be prohibited.

Applying for Canadian License

The operation of your Motorola Solutions radio is subject to the Radio communications Act and must comply with rules and regulations of the Federal Government's department of Innovation, Science, and Economic Development Canada (ISED). ISED requires that all operators using Private Land Mobile frequencies obtain a radio license before operating their equipment.

Prerequisites: Obtain the latest Canadian License Application form at http://www.ic.gc.ca/ic_wp-pa.htm.

Procedure:

1. Fill in the items as per the instructions. Be sure to print legibly.
If you need additional space for any item, use the reverse side of the application.
2. Make a copy of your files.
3. Prepare a cheque or money order payable to the "Receiver General for Canada", for an amount for each radio purchased.
The license is renewed on April 1st each year, and issued for a period of 12 months.
4. Mail your completed application along with your cheque or money order to the closest ISED office.

Important Safety Information

RF Energy Exposure and Product Safety Guide for Portable Two-Way Radios



ATTENTION:

This radio is restricted to Occupational use only.

Before using the radio, read the RF Energy Exposure and Product Safety Guide for Portable Two-Way Radios which contains important operating instructions for safe usage and RF energy awareness and control for Compliance with applicable standards and Regulations.

For a list of Motorola Solutions-approved antennas, batteries, and other accessories, visit the following website:

<https://www.motorolasolutions.com>

Under Innovation, Science, and Economic Development Canada (ISED) regulations, this radio transmitter may only operate using an antenna of a type and maximum (or lesser) gain approved for the transmitter by ISED. To reduce potential radio interference to other users, the antenna type and its gain should be so chosen that the equivalent isotropically radiated power (e.i.r.p.) is not more than that necessary for successful communication.

This radio transmitter is approved by ISED to operate with a Motorola Solutions-approved antenna with the maximum permissible gain and required antenna impedance for each antenna type indicated. Antenna types not included in this list, having a gain greater than the maximum gain indicated for that type, are strictly prohibited for use with this device.

Limited Warranty

MOTOROLA SOLUTIONS COMMUNICATION PRODUCTS

I. WHAT THIS WARRANTY COVERS AND FOR HOW LONG:

MOTOROLA SOLUTIONS, INC. (“MOTOROLA”) warrants the MOTOROLA SOLUTIONS manufactured Communication Products listed below (“Product”) against defects in material and workmanship under normal use and service for a period of time from the date of purchase as scheduled below:

APX N70	One (1) Year
Product Accessories	One (1) Year

MOTOROLA SOLUTIONS, at its option, will at no charge either repair the Product (with new or reconditioned parts), replace it (with a new or reconditioned Product), or refund the purchase price of the Product during the warranty period provided it is returned in accordance with the terms of this warranty. Replaced parts or boards are warranted for the balance of the original applicable warranty period. All replaced parts of Product shall become the property of MOTOROLA SOLUTIONS.

This express limited warranty is extended by MOTOROLA SOLUTIONS to the original end user purchaser only and is not assignable or transferable to any other party. This is the complete warranty for the Product manufactured by MOTOROLA SOLUTIONS. MOTOROLA SOLUTIONS assumes no obligations or liability for additions or modifications to this warranty unless made in writing and signed by an officer of MOTOROLA SOLUTIONS.

Unless made in a separate agreement between MOTOROLA SOLUTIONS and the original end user purchaser, MOTOROLA SOLUTIONS does not warrant the installation, maintenance or service of the Product.

MOTOROLA SOLUTIONS cannot be responsible in any way for any ancillary equipment not furnished by MOTOROLA SOLUTIONS which is attached to or used in connection with the Product, or for operation of the Product with any ancillary equipment, and all such equipment is expressly excluded from this warranty. Because each system which may use the Product is unique, MOTOROLA SOLUTIONS disclaims liability for range, coverage, or operation of the system as a whole under this warranty.

MOTOROLA SOLUTIONS offers the following optional extended service contracts.

DEVICE MANAGED SERVICES (DMS) ACCIDENTAL DAMAGE

Provides for extended hardware repair coverage INCLUDING CHEMICAL, LIQUID, FIRE, AND OTHER PHYSICAL DAMAGE. Accidental damage coverage is available in conjunction with MOTOROLA SOLUTIONS'S standard Commercial Warranty and starts from the FIRST DAY the radio is put into use. Service performed under this plan consists of repair or replacement of the covered equipment as set forth in the terms and conditions. Repairs will be made only at the designated MOTOROLA SOLUTIONS repair depot. Local services are not included. MOTOROLA SOLUTIONS will pay the inbound shipping charges only with use of the MOTOROLA SOLUTIONS designated delivery service. MOTOROLA SOLUTIONS will pay for outbound shipping via MOTOROLA SOLUTIONS'S normal shipping methods.

DEVICE MANAGED SERVICES (DMS) STANDARD HARDWARE

Provides extended hardware normal wear and tear repair coverage beginning AFTER MOTOROLA SOLUTIONS'S standard Commercial Warranty period expires. Service performed under this plan consists of repair of the covered equipment as set forth in the terms and conditions. Repairs will be made only

at the designated MOTOROLA SOLUTIONS repair depot. Local services are not included. MOTOROLA SOLUTIONS will pay for outbound shipping via MOTOROLA SOLUTIONS'S normal shipping methods.

II. GENERAL PROVISIONS:

This warranty sets forth the full extent of MOTOROLA SOLUTIONS'S responsibilities regarding the Product. Repair, replacement, or refund of the purchase price, at MOTOROLA SOLUTIONS's option, is the exclusive remedy. THIS WARRANTY IS GIVEN IN LIEU OF ALL OTHER EXPRESS WARRANTIES. IMPLIED WARRANTIES, INCLUDING WITHOUT LIMITATION, IMPLIED WARRANTIES OF MERCHANTABILITY AND FITNESS FOR A PARTICULAR PURPOSE, ARE LIMITED TO THE DURATION OF THIS LIMITED WARRANTY. IN NO EVENT SHALL MOTOROLA SOLUTIONS BE LIABLE FOR DAMAGES IN EXCESS OF THE PURCHASE PRICE OF THE PRODUCT, FOR ANY LOSS OF USE, LOSS OF TIME, INCONVENIENCE, COMMERCIAL LOSS, LOST PROFITS OR SAVINGS OR OTHER INCIDENTAL, SPECIAL OR CONSEQUENTIAL DAMAGES ARISING OUT OF THE USE OR INABILITY TO USE SUCH PRODUCT, TO THE FULL EXTENT SUCH MAY BE DISCLAIMED BY LAW.

III. STATE LAW RIGHTS:

SOME STATES DO NOT ALLOW THE EXCLUSION OR LIMITATION OF INCIDENTAL OR CONSEQUENTIAL DAMAGES OR LIMITATION ON HOW LONG AN IMPLIED WARRANTY LASTS, SO THE ABOVE LIMITATION OR EXCLUSIONS MAY NOT APPLY.

This warranty gives specific legal rights, and there may be other rights, which may vary from state to state.

IV. HOW TO GET WARRANTY SERVICE:

You must provide proof of purchase (bearing the date of purchase and Product item serial number) in order to receive warranty service and, also, deliver or send the Product item, transportation and insurance prepaid, to an authorized warranty service location. Warranty service will be provided by MOTOROLA SOLUTIONS through one of its authorized warranty service locations. If you first contact the company which sold you the Product (e.g., dealer or communication service provider), it can facilitate your obtaining warranty service. You can also call MOTOROLA SOLUTIONS at 1-800-927-2744 US/Canada.

V. WHAT THIS WARRANTY DOES NOT COVER:

1. Defects or damage resulting from use of the Product in other than its normal and customary manner.
2. Defects or damage from misuse, accident, water, or neglect.
3. Defects or damage from improper testing, operation, maintenance, installation, alteration, modification, or adjustment.
4. Breakage or damage to antennas unless caused directly by defects in material workmanship.
5. A Product subjected to unauthorized Product modifications, disassembles, or repairs (including, without limitation, the addition to the Product of non-MOTOROLA SOLUTIONS supplied equipment) which adversely affect performance of the Product or interfere with MOTOROLA SOLUTIONS's normal warranty inspection and testing of the Product to verify any warranty claim.
6. Product which has had the serial number removed or made illegible.
7. Rechargeable batteries if:
 - any of the seals on the battery enclosure of cells are broken or show evidence of tampering.
 - the damage or defect is caused by charging or using the battery in equipment or service other than the Product for which it is specified.
8. Freight costs to the repair depot.

9. A Product which, due to illegal or unauthorized alteration of the software/firmware in the Product, does not function in accordance with MOTOROLA SOLUTIONS's published specifications or the FCC certification labeling in effect for the Product at the time the Product was initially distributed from MOTOROLA SOLUTIONS.
10. Scratches or other cosmetic damage to Product surfaces that does not affect the operation of the Product.
11. Normal and customary wear and tear.

VI. PATENT AND SOFTWARE PROVISIONS:

MOTOROLA SOLUTIONS will defend, at its own expense, any suit brought against the end user purchaser to the extent that it is based on a claim that the Product or parts infringe a United States patent, and MOTOROLA SOLUTIONS will pay those costs and damages finally awarded against the end user purchaser in any such suit, which are attributable to any such claim, but such defense and payments are conditioned on the following:

1. that MOTOROLA SOLUTIONS will be notified promptly in writing by such purchaser of any notice of such claim,
2. that MOTOROLA SOLUTIONS will have sole control of the defense of such suit and all negotiations for its settlement or compromise, and
3. should the Product or parts become, or in MOTOROLA SOLUTIONS' opinion be likely to become, the subject of a claim of infringement of a United States patent, that such purchaser will permit MOTOROLA SOLUTIONS, at its option and expense, either to procure for such purchaser the right to continue using the Product or parts or to replace or modify the same so that it becomes non-infringing or to grant such purchaser a credit for the Product or parts as depreciated and accept its return. The depreciation will be an equal amount per year over the lifetime of the Product or parts as established by MOTOROLA SOLUTIONS.

MOTOROLA SOLUTIONS will have no liability with respect to any claim of patent infringement, which is based upon the combination of the Product or parts furnished hereunder with software, apparatus or devices not furnished by MOTOROLA SOLUTIONS, nor will MOTOROLA SOLUTIONS have any liability for the use of ancillary equipment or software not furnished by MOTOROLA SOLUTIONS, which is attached to or used in connection with the Product. The foregoing states the entire liability of MOTOROLA SOLUTIONS with respect to infringement of patents by the Product or any parts thereof.

Laws in the United States and other countries preserve for MOTOROLA SOLUTIONS certain exclusive rights for copyrighted MOTOROLA SOLUTIONS software such as the exclusive rights to reproduce in copies and distribute copies of such MOTOROLA SOLUTIONS software. MOTOROLA SOLUTIONS software may be used in only the Product in which the software was originally embodied and such software in such Product may not be replaced, copied, distributed, modified in any way, or used to produce any derivative thereof. No other use including, without limitation, alteration, modification, reproduction, distribution, or reverse engineering of such MOTOROLA SOLUTIONS software or exercise of rights in such MOTOROLA SOLUTIONS software is permitted. No license is granted by implication, estoppel or otherwise under MOTOROLA SOLUTIONS patent rights or copyrights.

VII. GOVERNING LAW:

This Warranty is governed by the laws of the State of Illinois, U.S.A.

VIII. For Australia Only

This provision applies to products and services supplied by Motorola Solutions to consumers within the meaning of the Australian Consumer Law. This warranty is given by Motorola Solutions Australia Pty Limited (ABN16 004 742 312) of Tally Ho Business Park, 10 Wesley Court, Burwood East, Victoria. Our goods come

with guarantees that cannot be excluded under the Australia Consumer Law. For major failures with the service, you are entitled:

- To cancel your service contract with us: and
- To a refund for the unused portion, or to compensation for its reduced value.

You are entitled to choose a replacement or refund for a major failure with goods. If a failure with the goods or service does not amount to a major failure, you are entitled to have the failure rectified in a reasonable time. If this is not done, you are entitled to a refund for the goods, and to cancel the contract for the service and obtain a refund of any unused portion. You are also entitled to be compensated for any other reasonably foreseeable loss or damage from a failure in the goods or service. If you have any queries, please call Motorola Solutions Australia at 1800 457 439. You may also visit our website: https://www.motorolasolutions.com/en_xa/support.html for current warranty terms.

Read Me First

This User Guide covers the basic operation of the radio.

Notations Used in This Manual

Notations such as **Warning**, **Caution**, and **Notice** are used throughout the text in this publication. These notations are used to emphasize that safety hazards exist, and the care that must be taken or observed.



WARNING: An operational procedure, practice, or condition, and so on, which can result in injury or death if not carefully observed.





CAUTION: An operational procedure, practice, or condition, and so on, which can result in damage to the equipment if not carefully observed.



NOTE: An operational procedure, practice, or condition, and so on, which is essential to emphasize.

The following special notations identify certain items.

Example	Description
Home button or 	Buttons and keys are shown in bold print or as an icon.
Phon	Menu entries are shown similar to the way that they appear on the display of the radio.
	This means “Press the right side of the 4-Way Navigation button.”

What Your Dealer or System Administrator Can Tell You

Your dealer or system administrator can customize your radio to your specific needs. If the radio is to be operated in extreme temperatures (less than -30 °C or more than +60 °C), check with your system administrator for the correct radio settings.

You can consult your dealer or system administrator about the following:

- Is your radio programmed with any preset conventional channels?
- Which buttons have been programmed to access other features?
- What optional accessories suit your needs?



NOTE: Specifications vary for different radio models. For more information, contact your system administrator.





Software Version

All the features described in the following sections are supported by the software version **R03.00.00** or later.

Contact your system administrator for more details of all the supported features.

Touchscreen Navigation

Table 1: Touchscreen Actions

Action	Results
<p>Tap</p> 	<p>You can tap to perform the following actions:</p> <ul style="list-style-type: none">• Select items on the screen• Type letters and symbols using the onscreen keyboard• Press on-screen buttons
<p>Tap and hold</p> 	<p>You can tap and hold to perform the following actions:</p> <ul style="list-style-type: none">• Drag an application on the home screen to move it to a new location or to remove it• Create a shortcut of an application on the home screen• At an empty area of the home screen, tap and hold to launch a menu to select wallpapers, widgets and Home settings
<p>Swipe</p> 	<p>You can move your finger up, down, left, or right on the screen to perform the following actions:</p> <ul style="list-style-type: none">• Unlock the screen• View additional home screens• View additional application icons in the Launcher window• View more information on an application screen
<p>Double-tap</p> 	<p>You can tap twice on a webpage, map, or other screen to zoom in and out.</p>

Action

Results

Pinch

In some applications, you can zoom in and out by placing two fingers on the screen and pinching them together (to zoom out) or spreading them apart (to zoom in).



Chapter 1

Radio Care

Proper radio usage and care ensure efficient operation and long life of the product.



CAUTION: Use the radio according to the following recommendations and warnings.

- Your radio casing has a vent port for pressure equalization in the radio. Never poke this vent with objects such as needles, tweezers, or screwdrivers. Poking the vent could create leak paths into the radio and the radio submergibility will be lost.
- Never obstruct or cover the vent port, even with a label.
- Ensure that no oily substances come in contact with the vent port.
- Your radio is designed to be submerged to a maximum depth of 6 feet and maximum time of 2 hours. Exceeding either maximum limit may result in damage to the radio.
- Elastomer seals used in portable radios age with time and environmental exposure. To ensure the waterseal integrity of the radio, Motorola Solutions recommends that radios be checked annually as a preventive measure. The disassembly, test, and reassembly procedures along with necessary test equipment are available in the *Service Manual*.
- If the radio battery contacts are exposed to water without the battery attached, dry and clean the radio battery contacts before attaching a battery to the radio. Turn the radio over with the battery contact facing down and shake the radio so any trapped water can escape. A short circuit of the contacts could occur if they are not dried properly.
- If the radio has been submerged in water, shake the radio to remove any water that is trapped inside the speaker grille and microphone port. Otherwise, the water decreases the audio quality of the radio.
- If an accessory is not attached to the radio, ensure that the accessory connector cover is attached to the radio side accessory connector.
- If the radio is submerged or exposed to a high force water spray, such as from a hose, remove the accessory or accessory connector cover immediately and ensure that no water is forced into the accessory connector/radio interface. Rinse and dry the area and re-attach the accessory or accessory connector cover if leakage occurs.
- If the radio is exposed to a corrosive environment, such as salt water or corrosive gases or liquids, rinse and clean the radio immediately to prevent damage to radio materials, especially plated surfaces. Remove the battery and the antenna before cleaning.
- Do **not** disassemble the radio as you could damage radio seals and result in leak paths into the radio. Any radio maintenance should be performed only by a qualified radio technician.
- Only Underwriter Laboratory (UL) approved service centers can open and service UL certified radios. Opening or repairing at unauthorized locations invalidates hazardous location rating of the radio.
- Do **not** pound, drop, or throw the radio unnecessarily.
- Turn off the radio when charging the radio using a wall-mounted charger. Otherwise, the Fall Alert and Emergency may be accidentally triggered.
- When cleaning the radio, do not use a high-pressure jet spray as this may exceed the depth pressure and cause water to leak into the radio.

1.1

Cleaning Your Radio



CAUTION: Do **not** use solvents to clean your radio as most chemicals may permanently damage the radio housing and textures.

Do **not** submerge the radio in the detergent solution.

To clean the external surfaces of your radio, perform the following:

Procedure:

1. Combine one teaspoon of mild dishwashing detergent to one gallon of water (0.5% solution).
2. Apply the solution sparingly with a stiff, non-metallic, shortbristled brush, making sure that excess detergent does not get entrapped near the connectors, controls, or crevices.
3. Rinse and then dry the radio thoroughly with a soft, lint-free cloth.
4. Clean battery contacts with a lint-free cloth to remove dirt or grease.

1.2

Radio Service and Repair

Proper repair and maintenance procedures ensure efficient operation and long-life of this radio. A Motorola Solutions maintenance agreement provides expert service to keep the radio and all other communication equipment in perfect operating condition.

A nationwide service organization is provided by Motorola Solutions to support maintenance services. Through its maintenance and installation program, Motorola Solutions makes the finest service available to those desiring reliable continuous communications on a contract basis.

For a contract service agreement, contact your nearest Motorola Solutions service or sales representative, or an authorized Motorola Solutions dealer.

1.3

Battery Recycling and Disposal

In the U.S. and Canada, Motorola Solutions participates in the nationwide Call2Recycle program for battery collection and recycling. Many retailers and dealers participate in this program.

For the location of the drop-off facility closest to you, go to <http://www.call2recycle.org/> or call 1-800-8-BATTERY. This website and telephone number also provide other useful information concerning recycling options for consumers, businesses, and governmental agencies.

Chapter 2

Radio Overview

Figure 1: Radio Overview



Table 2: Radio Overview Description

Number	Name	Description
1	RF Antenna	Transmits and receives electromagnetic waves during transmitting and receiving.
2	Status LED	Indicates the operating status of the radio.
3	ABC Switch	This switch is usually programmed for zone selection.
4	Touch Screen	The front radio display screen with touch sensitivity function.
5	Display Sleep/Wake and Home button	Pressing this button wakes or puts the radio to sleep. Pressing and holding this button brings you back to the Home screen.

Number	Name	Description
6	P1 to P6 Programmable buttons	Use these programmable buttons to access programmed functions or, enable or disable features.
7	Battery Latch	This latch locks the battery in place.
8	2-Dot (Side Bottom) Feature button	Use this programmable button to access a programmed function or, enable or disable a feature.
9	1-Dot (Side Middle) Feature button	Use this programmable button to access a programmed function or, enable or disable a feature.
10	Push-to-Talk (PTT) button	Allows you to execute voice operations.
11	Purple (Side Top) button	Use this programmable button to access a programmed function or, enable or disable a feature.
12	High Dynamic Range (HDR) Mic 1	Converts sound into electric signals.
13	On/Off/Volume Control knob	Allows you to turn the radio on or off, and adjust the volume.
14	Channel Selector	Allows you to select channels.
15	2-Position Concentric Switch	This switch is usually programmed to enable or disable secure operation.
16	Top Display	The top radio display screen.
17	High Dynamic Range (HDR) Mic 2	Converts sound into electric signals.
18	3-Dot (Speaker Grill) Feature button	Use this programmable button to access a programmed function or, enable or disable a feature.
19	Speaker	Converts electric signals into sound and audio output.
20	Near Field Communication (NFC) Antenna	Allows two devices that are close to each other to connect and communicate.
21	Battery	Provides battery power for your radio.
22	Charging Contacts	Charging point for the battery.
23	Accessory Connector	Allows you to connect accessories to your radio.
24	Top (Orange) button	Allows you to turn on and off Emergency Operations. Besides the Emergency Operation, this button can also be configured for other features.

2.1

Programmable Radio Functions

Your system administrator can program the programmable buttons or switches as shortcuts to radio functions depending on the duration of a button press. Contact your system administrator to learn more about the radio functions assigned to the programmable buttons and switches of your radio.

Table 3: Assignable Radio Functions

Function	Description
Audio Playback	<p>To play the last saved call audio followed by other saved audio in the sequence from oldest to newest.</p> <p>To save the received call audio into your radio, press and hold the button.</p> <p> NOTE: These programmable buttons do not function if the radio is in the Recents menu.</p>
Basic Zone Bank	Switches between Basic Zone Bank 1 and Basic Zone Bank 2.
Bluetooth On/Off	<p>To turn on or off the Bluetooth, press the button.</p> <p>To clear all the Bluetooth devices information, press and hold the button.</p>
Bluetooth Configuration	Allows you to access the Bluetooth menu.
Bluetooth Audio Reroute	Allows you to toggle the audio route between the radio speaker or the Remote Speaker Microphone and the Bluetooth headset.
Bluetooth Headset PTT	Keys up the Bluetooth Headset microphone.
Call Response	Allows you to answer a private call.
Channel Up/Down	Allows you to scroll up or down to other channels within the current Zone.
Chanel Select	Allows you to select a channel from the switch.
Channel Search	Allows you to search for a channel.
Contacts	Allows you to access the Contacts menu.
Dynamic Priority (Conventional Only)	Allows any channel in a Scan List (except for a Priority-One channel) to temporarily replace the Priority-Two channel.
Emergency	Allows you to send or cancel Emergency Alarm to the dispatcher.
Fall Alert Clear	Allows you to clear the Fall Alert mode alarm and exit Fall Alert feature.
In-Call User Alert	Allows the radio to remain muted to affiliated talkgroup calls while operating on the current Trunking Personality or conventional channel.
Light/Flip	<p>To turn on the display backlight on and off, press the button.</p> <p>To flip the screen orientation of the top display, press and hold the button.</p>
Location	Toggles the GPS/Location capabilities on and off.

Function	Description
Mode Select (MS01– MS13)	<p>To change to the preset Mode Select zone and channel, press the button.</p> <p>When the Preconfigurable Preset Zone and Channel field is enabled, to save the current zone and channel to one of the Mode Select menus, press and hold the preferred Mode Select menu.</p>
Monitor (Conventional Only)	<p>Monitors a selected channel for all radio traffic until the function is disabled.</p>
Nuisance Delete	<p>Temporarily removes an unwanted channel from scan list, except for priority channels and the designated transmit channel.</p>
Private Call (Trunking Only)	<p>Allows you to dial the programmed ID (number) and initiate the Private Call.</p>
Priority Dispatch	<p>Allows you to call the dispatcher on a different talkgroup.</p>
Radio Profiles	<p>Allows you to access a set of programmed visual and audio settings of the radio.</p>
Record Playback	<p>Allows you to saves and playback recorded calls.</p>
Rekey Request	<p>Notifies the dispatcher that a new encryption key is needed.</p>
Remote Monitor	<p>Enables the system administrator to remotely command a targeted radio.</p>
Repeater Access Button (RAB) (Conventional Only)	<p>Allows you to manually send a repeater access codeword.</p>
Reprogram Request (Trunking Only)	<p>Notifies the dispatcher that a new dynamic regrouping assignment is needed.</p>
Request-To-Talk (Conventional Only)	<p>Notifies the dispatcher that you want to send a voice call.</p>
Scan	<p>To turn on or off the scan function, press the button.</p> <p>To enable Scan List Programming and selects the scan list for editing, press and hold the button.</p> <p> NOTE: If this function is programmed to a radio switch, you cannot change the scan mode on the Radio Quick Settings menu.</p>
Secure Transmission Select	<p>Toggles the Secure Transmission on and off when the Secure/Clear Strapping field is set to Select for the current channel.</p>
Site Display/Search (Trunking Only)	<p>To display the current site ID and Received Signal Strength Indicator (RSSI) value.</p> <p>To perform site search for Automatic Multiple Site Select (AMSS) or SmartZone operation, press and hold the button.</p>
Site Lock/Unlock (Trunking Only)	<p>Allows your radio to lock onto a specific site.</p>
Status (Trunking Only)	<p>Sends data calls to the dispatcher about a predefined status.</p>
Status Call	<p>Sends data calls to the dispatcher about a predefined status.</p>

Function	Description
Talkaround/Direct (Conventional Only)	Toggles between using a repeater or communicating directly with another radio.  NOTE: If this function is programmed to a radio switch, you cannot change the talkaround/direct mode on the Radio Quick Settings menu.
Text Messaging Service (TMS)	Allows you to access the Text Messaging Service (TMS) menu.
TMS Quick Text	Selects a predefined message.
User	Allows you to log on to the server with a personally identifiable user name.
Voice Announcement	Audibly indicates the current feature mode, zone, or channel that you are assigned to.
Voice Mute	Allows you to mute the voice transmission of the current zone and channel.
Volume Set Tone	Sets the volume set tone.
Zone Bank Up	Scrolls through the zone banks in ascending order.
Zone Bank Down	Scrolls through the zone banks in descending order.
Zone Select	Allows you to select a zone from the switch.

2.2

ViQi

ViQi is a virtual assistant that helps you manage your radio and perform information lookups using voice commands. This feature is purpose-built for public safety and is active when you press the assigned ViQi button on the radio or an associated Remote Speaker Microphone (RSM).

ViQi Voice Control

ViQi Voice Control allows you to operate the radio with your voice, for example, to change zones, channels, or volume.



 **NOTE:** Voice Control follows the language that you set in the device. If you changed the device language in RadioCentral or Customer Programming Software (CPS), your device automatically downloads the new language files for this feature through LTE or Wi-Fi. This feature is disabled until the language files are downloaded successfully. Therefore, retry if your download fails.

Table 4: ViQi Voice Control Commands

The following table shows the functions supported by the ViQi Voice Control feature and their respective commands.

Feature	Examples
Zone and Channel	To identify your current zone and channel, say: <ul style="list-style-type: none"> • “What is my zone and channel?” • “Current zone and channel” • “Zone and channel” <hr/> To change to a new zone and channel, say:

Feature	Examples
Zone	<ul style="list-style-type: none">● “Zone <i><zone name></i>, channel <i><channel name></i>”● “Change zone to <i><zone name></i>, channel to <i><channel name></i>”● “Switch zone to <i><zone name></i>, channel to <i><channel name></i>” <p>To identify your current zone, say:</p> <ul style="list-style-type: none">● “What is my zone?”● “Current zone”● “Zone” <p>To change to a new zone, say:</p> <ul style="list-style-type: none">● “Zone <i><zone name></i>”● “Change zone to <i><zone name></i>”● “Switch zone to <i><zone name></i>”
Channel	<p>To identify your current channel, say:</p> <ul style="list-style-type: none">● “What is my channel?”● “Current channel”● “Channel” <p>To change to a new channel, say:</p> <ul style="list-style-type: none">● “Channel <i><channel name></i>”● “Change channel to <i><channel name></i>”● “Switch channel to <i><channel name></i>”
Home Channel	<p>To change to your home channel, say:</p> <ul style="list-style-type: none">● “Home channel”● “Change to home channel”● “Switch to home channel”
Volume	<p>To identify the volume level of your radio, say:</p> <ul style="list-style-type: none">● “What is my volume?”● “Current volume”● “Volume” <p>To change the volume level of your radio, say “Volume <i><volume level></i>”.</p> <p>The available commands and their respective volume levels are as follows:</p> <ul style="list-style-type: none">● <i><low></i> – 10%● <i><medium></i> – 50%● <i><high></i> – 100%● <i><1></i> to <i><10></i> – 10% to 100%
Cancel Last Command	<p>To cancel your previous command, say “Cancel”.</p> <p> NOTE: Cancel command works within a five-second window after the last command.</p>

Feature	Examples
Profile	To change to a new profile, say: <ul style="list-style-type: none"> • “<profile name> profile” • “Change to <profile name> profile” • “Switch to <profile name> profile”
Scan	To start or stop scanning, say: <ul style="list-style-type: none"> • “Start scan” • “Stop scan” • “Start scanning” • “Stop scanning”
Battery	To identify your battery level, say: <ul style="list-style-type: none"> • “What is my battery level?” • “Battery level” • “Battery”
Time	To identify current time, say: <ul style="list-style-type: none"> • “What is the time?” • “What time is it?” • “Current time” • “Time check” • “Time”
Initiate ViQi Virtual Partner	“Hey ViQi” “Look up information”  NOTE: These commands are used to initiate Virtual Partner when both Voice Control and Virtual Partner are programmed on the same ViQi button.

ViQi Virtual Partner



ViQi Virtual Partner helps you to look up information such as license plate, driver's license, and Vehicle ID Number (VIN), and she responds with a result to your query.

Table 5: ViQi Virtual Partner Queries

The following table shows the queries supported by the ViQi Virtual Partner feature and their respective commands. Use the following commands followed by the supported query instructions to initiate ViQi Virtual Partner:

- “Look up...”
- “Check...”
- “Run a...”

Query	Examples
License plate	“Run a <state> license plate <alphanumeric string>”

Query	Examples
	“Check a <state> license plate” “Look up <state> license plate <alphanumeric string>”
Driver's license	“Run a <state> driver's license <alphanumeric string>” “Check the state of <state> driver's license <alphanumeric string>” “Look up <state> driver's license<alphanumeric string>”
Vehicle Identification Number	“Check Vehicle Identification Number <alphanumeric string>” “VIN check <alphanumeric string>” “Run a VIN”  NOTE: You can use variations such as <Vehicle Identification Number>, <VIN>, and <Vehicle Number>.
Own Location	“Where am I?” “Can I get my exact location?” “Am I still at the <location> ?”  NOTE: ViQi will ask for more information to complete the query.
Target Location	“Where is <unit name> ?” “Tell me where <unit name> is”  NOTE: ViQi will ask for more information to complete the query.

You are also able to receive and listen to LMR and Virtual Partner over broadband audio simultaneously. These audio mixing is configurable and must be preprogrammed by a qualified radio technician. Check with your dealer or system administrator for more information.

2.2.1 Using ViQi

Perform the following procedure to activate ViQi for the Voice Control or Virtual Partner features.

Prerequisites:

- See [ViQi on page 27](#) for the queries supported by this feature.
- To perform the queries, you are required to log in to CommandCentral. See [Logging In to CommandCentral on page 40](#).

Procedure:

1. Press and hold the assigned **ViQi** button.
2. After you hear a tone, speak your request into the microphone.
3. Release the assigned programmable button and wait for ViQi to respond.
4. Throughout your session, repeat steps [step 1](#) through [step 3](#) when responding to ViQi. Depending on your query, you can also say the following requests:
 - To display a list of preferred voice commands in any supported languages, say “What can I say?”
 - To play the available results, say “Play results”.

- To request for more details, say “More details”.
- To complete the Virtual Partner session, say “Complete”.

Chapter 3

Getting Started

This section provides instructions to prepare your radio for use.

3.1

Attaching and Removing the Battery

The radio notifies you if it detects a non-Motorola Solutions battery when powering up, charging, or removed from the charger.

Attaching the Battery

Procedure:

1. At the battery compartment, align the battery with the bottom rails.
2. Slide the battery into the radio frame until the side latches click into place.

Removing the Battery

Procedure:

1. Press the latches on both sides.
2. Pull the battery away from the radio.

3.2

Attaching and Removing the Antenna

Attaching the Antenna

Prerequisites: Turn off the radio.

Procedure:

1. Set the bottom of the antenna into the antenna receptacle.
2. Turn the antenna clockwise and tighten the antenna securely on the radio.

Removing the Antenna

Prerequisites: Turn off the radio.

Procedure:

1. Turn the antenna counterclockwise until loose.
2. Lift the antenna from the antenna receptacle.

3.3

Inserting or Removing the SIM Card

Prerequisites: Remove the battery from the radio and hold the radio with the speaker grille facing up.

Procedure:

1. Gently pull the tab to slide out the SIM card tray.



NOTE: The SIM card tray must not be removed with a hook or prying tool.

2. Perform one of the following actions:
 - Insert the SIM Card in the SIM card tray where the letters "TOP" is facing away from the chassis of the radio.
 - Remove the SIM card from the tray.
3. Push the SIM card tray back into the radio and avoid bending it sideways or up or down.



NOTE: If the SIM card tray does not slide freely, check the orientation of the tray and reseal the SIM card.

3.4

Attaching and Removing the Accessory Connector Cover

The connector cover shields the accessory connector from damage when not in use.

Attaching the Accessory Connector Cover

Procedure:

1. Insert the slanted end into the slot above the connector.
2. Push connector upward.
3. Press downwards on the accessory connector.
4. Rotate the thumbscrew clockwise to tighten the cover.

Removing the Accessory Connector Cover

Procedure:

1. Rotate the thumbscrew counterclockwise until it disengages from the radio.
2. Rotate outwards and lift the connector cover to disengage it from the radio.

3.5

Using the Carry Holder

Procedure:

1. To insert the radio into the carry holder, perform the following actions:
 - a. Position the radio within the carry holder with the main speaker facing outward.

- b. Slide the radio down into the carry holder until it clicks in place.
 2. To remove the radio from the carry holder, perform the following actions:
 - a. Place the tip of your fingers on the ledge of the carry holder.
 - b. Push the bottom of the radio until it is released from the carry holder.

3.6

Charging the Radio

Prerequisites:



WARNING:

To avoid possible explosion:

- Do **not** replace the battery in any area labeled **Hazardous Atmosphere**.
- Do **not** discard batteries in a fire.

Procedure:

1. Turn off the radio while charging in a single or multiunit charger.
2. Place the radio in a Motorola Solutions-approved charger.



NOTE: If the radio must remain powered on in the multiunit charger, LMR PTT is not allowed as possible degradation in performance may occur.

3.7

Turning the Radio On or Off

Turning the Radio On

Prerequisites: Ensure that the battery is fully charged before the first use.

Procedure:

Rotate the **On/Off/Volume Control Knob** clockwise until you hear a click.

Turning the Radio Off

Procedure:

Rotate the **On/Off/Volume Control Knob** counterclockwise until you hear a click.

3.8

Adjusting the Volume of the Radio

Procedure:

Perform one of the following actions:

- To increase the volume, rotate the **On/Off/Volume Control Knob** clockwise.
- To decrease the volume, rotate the **On/Off/Volume Control Knob** counterclockwise.

3.9

Adjusting the Display Brightness

Procedure:

1. From the **Home** screen, tap  **Brightness**.
2. Perform one of the following actions:
 - Drag the **Brightness Slider** to set a custom brightness level.
 - Tap **Auto Brightness** to automatically adjust the screen brightness based on the lighting conditions.

3.10

Turning On Night Mode

Procedure:

From the **Home** screen, tap  **Night Mode** to toggle between Day or Night Mode of the display.

3.11

Setting the Clock

Procedure:

1. From the **Home** screen, tap  **System Settings**.
2. Tap **Clock**, then perform one of the following actions:

Option	Actions
To toggle use 24-hour format on and off	Tap Use 24-hour format .
To toggle automatic time zone on and off	Tap Set Automatic .
To manually select time zone	<ol style="list-style-type: none">a. Toggle Set Automatic to off.b. Tap Select Time Zone.

3.12

Setting the Front Display Timer

This setting determines the period before the front display dims and turns off due to inactivity.

Procedure:

1. From the **Home** screen, tap  **System Settings**.
2. Tap **Display** → **Front Display Timer**.
3. Select the required period.

Chapter 4

Home Screen Overview

Figure 2: Home Screen Overview

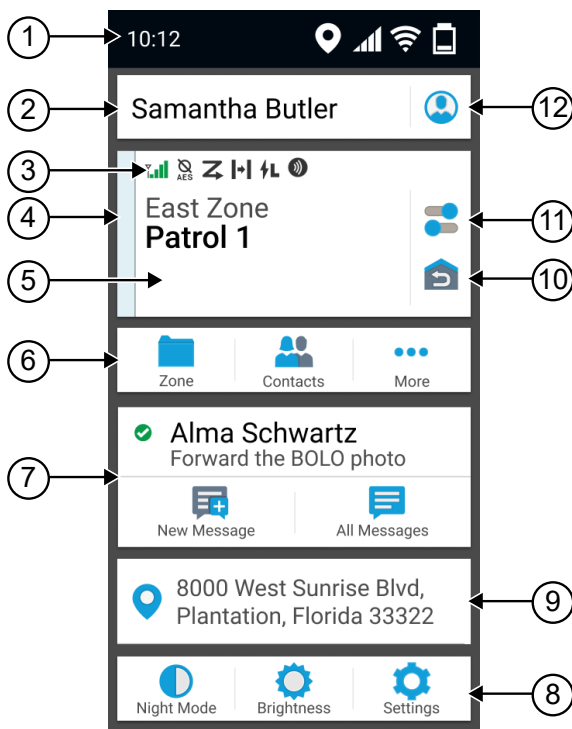





Table 6: Home Screen Overview Description

No.	Name	Description
1	Status Bar	Status icons appear in the status bar to provide device status and feature notifications.
2	Identity and Status Widget	Displays your email account when you are logged in. When you are logged out, radio alias will be shown on the widget.
3	Channel Status Icons	Provides information or status specific to the selected channel.
4	Transmit and Receive Indicator	Reflects the active call state of the radio.
5	Radio Control Widget	Displays channel errors, trunking statuses, call states, and notifications. Allows you to change zone and channel from the Home screen.

No.	Name	Description
6	Menu Feature Launcher Widget	<p>Displays the top two priority features provisioned in the Customer Programming Software (CPS).</p> <p>The  More option contains all other programmed menu items.</p>
7	Messages Widget	<p>Allows you to compose a new text message and view all messages in the inbox. Depending on the RadioCentral or CPS configuration of your radio, the widget opens the LMR messages or SmartMessaging application.</p> <p> NOTE: The number of unread messages are displayed on the all messages icon .</p>
8	Settings Widget	<p>Provides shortcuts to radio settings.</p> <p> System Settings contains other settings in the radio.</p>
9	Location Widget	<p>Displays the current location of your radio.</p> <p>Allows you to view and manage all location-related features. Depending on the RadioCentral or CPS configuration of your radio, the widget opens the Waypoints or Smart-Mapping application.</p>
10	Home Channel Revert	Allows you to revert to the Home Channel or Talkgroup.
11	Radio Quick Settings	Allows you to quickly toggle the radio communication settings. The settings are channel specific.
12	Shift Manager Launcher	Depending on the radio programming, this shortcut allows you to access your Radio Alias, User Login, Soft ID, CommandCentral Login, or Status list.

4.1

On-Screen Keyboard Overview

The on-screen keyboard only supports CCAAdmin login, Automatic Registration Service (ARS) user login, and Long Term Evolution (LTE) Access Point Names (APN) settings.

To enter alphanumeric text on your radio, you can use the keyboard in portrait or landscape orientation. Based on the language settings of your radio, you can also tap and hold a character to input alternate characters.

Figure 3: On-Screen Keyboard Overview

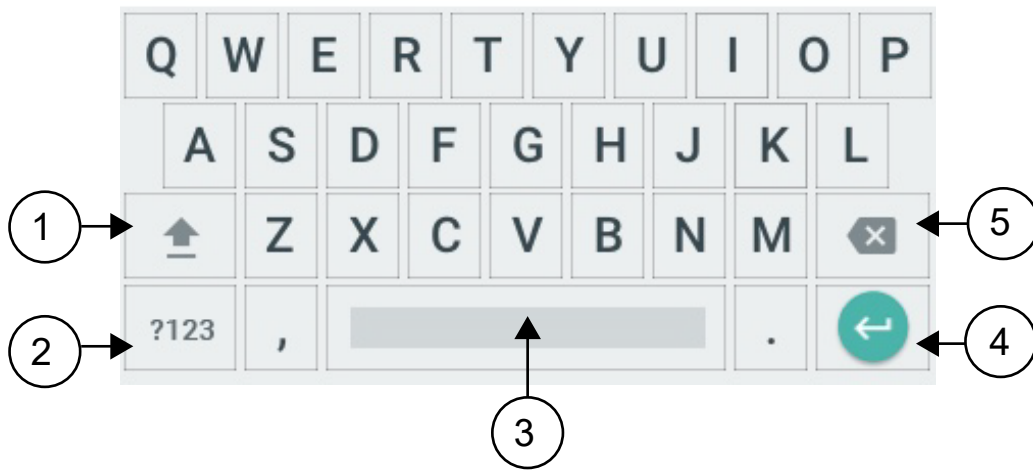

No.	Description
1	Tap to type in uppercase. Double-tap for caps lock.
2	Tap to input numbers, punctuation, or symbols.
3	Tap to insert space. Double-tap to insert a period.
4	Enter
5	Backspace

4.2

Identity and Status Widget

The Identity and Status Widget displays the identity of the radio with either the Radio Alias, Soft ID, or User Login. This widget also allows you to send the operational status directly from the home screen.

4.2.1

Managing Operational Status

Procedure:

1. From the **Home** screen, tap the **Identity and Status Widget**.
2. Select the available status.

4.2.2

User Login Feature

This feature allows you to take on a friendly username such as Text Messaging Service (TMS).

You can still send text messages without logging in as a user. The user login feature only enables the recipient of your message to identify you as the sender by assigning a username to your message. This feature is only applicable for Land Mobile Radio (LMR) Messaging.

4.2.2.1

Logging In to Automatic Registration Service

Procedure:

1. From the **Home** screen, tap **Shift Manager Launcher**.
2. Tap **User Login**, then perform one of the following actions:

Option	Actions
Log in with an existing ID	Tap the ID.
Log in with a new ID	<ol style="list-style-type: none"> a. Tap Login with new ID. b. Enter the User Login ID, then tap Done. ✓

3. Enter the authorized PIN, then tap ✓ **Done**.

If a PIN is not assigned to the ID, skip this step.

The display shows the **Progress** screen. If the channel does not support Automatic Registration Service login, the display shows the status as *Offline*.

4. While sign in is in progress, tap **Hide**.

Result: After the login is completed, the **Identity and Status Widget** shows the login ID.

4.2.2.2

Logging Out of Automatic Registration Service

Procedure:

1. From the **Home** screen, tap **Shift Manager Launcher**.
2. Tap your ID, then tap **Yes** to confirm the request.
3. Perform one of the following actions:
 - To clear the private data, tap **Yes**.
 - To keep your private data, tap **No**.

4.2.3

Entering the Soft ID

Soft ID entry is only allowed if it is enabled and User Login is not used.

Procedure:

1. From the **Home** screen, tap **Shift Manager Launcher**.
2. Tap **Soft ID**, then enter your Soft ID.
3. Tap  **Done** to confirm.



NOTE: If you leave the Soft ID empty, the **Work Manager Widget** displays the Radio Alias ID if it is enabled.

4.2.4

CommandCentral Authentication Login

To log into the CommandCentral for the first time, simply follow the First-Time Login steps as follows.



NOTE: After selecting **Remember my username**, the First-Time Login steps will be skipped on subsequent logins.

After you have logged in, you can view your agency details (Agency name, Unit ID, Auto logout date and time). You will be notified when you are about to be logged out when you see a logout timer on the widget. The timer is displayed 1 hour before the logout time if the session timeout is set to less than 29 days, or 20 hours before if session timeout is set to more than 29 days.

4.2.4.1

Logging In to CommandCentral



Procedure:

1. From the **Home** screen, tap **Shift Manager Launcher**.
2. Login using one of the following options:

Option	Actions
User Authentication via email and username	<ol style="list-style-type: none">a. Tap CommandCentral Login.b. Enter your Username/ E-mail address and Password.
Device certificate authentication	<ol style="list-style-type: none">a. Tap CommandCentral Login. <p> NOTE: The device automatically logon at power up.</p>

3. Depending on your login attempt, use one of the following options:

Option	Actions
First-time login	<ol style="list-style-type: none">a. Tap Sign On.b. Scroll down and tap the Received passcodes via email (if two-factor authentication is enabled).c. Enter the passcode and tap Verify to complete the login (if two-factor authentication is enabled).

Option	Actions
Subsequent login	<p>a. Tap Sign On, then enter the verification code generated by your device (if two-factor authentication is enabled).</p> <p>b. Tap  to complete the log in.</p> <p> NOTE: You can request to resend the code to the connected device. The code is 8 characters and can be alphanumeric.</p>

4.2.4.2

Logging Off CommandCentral

Procedure:

1. From the **Home** screen, tap **Shift Manager Launcher**.
2. To log out of CommandCentral, tap on your username or email address listed under **CommandCentral Login**.

4.2.5

Updating Unit ID

Prerequisites: Field users must log in before changing Unit ID.

Procedure:

1. From the **Home** screen, tap  **Shift Manager Launcher**.
2. Update the Unit ID by using the following options:

Option	Actions
Updating Unit ID for the first time	<p>a. At the Shift Manager screen, tap on My Unit ID.</p> <p>b. Tap on the required Unit ID and wait until the requested ID is completely assigned.</p>
Updating Unit ID from Recents list	<p>a. At the Shift Manager screen, tap on My Unit ID.</p> <p>b. Tap on the Recents.</p> <p>c. Tap on the required Unit ID and wait until the requested ID is completely assigned.</p>



4.2.6

Updating On/Off Duty Status

Prerequisites: Field users must log in before changing On/Off duty status.

Procedure:

Update the On/Off duty status by using the following options:

Option	Actions
From the Shift Manager	<p>a. From the Home screen, tap  Shift Manager Launcher.</p> <p>b. From the Shift Manager screen, tap  on My Status to toggle between On or Off duty status.</p>
From the Home Screen	<p>a. From the Home screen, tap  Shift Manager Launcher.</p> <p>b. At My Status screen, tap on the Duty Status to toggle between On or Off duty status.</p>

4.3







Status Indicators









This section explains the status indicators of the radio.

4.3.1







Radio Icons



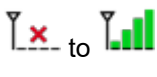





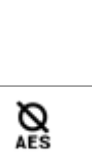

These icons appear at the status bar to provide device-specific information or status.

Icon	Name	Description
 (Front display)	Battery	Indicates the remaining battery level of the radio. The icon blinks when the battery level drops to 10% or lower.
	Bluetooth® On	Bluetooth is connected to an external device.
	GPS	GPS is enabled and its signal is available.
	No SIM	SIM card is not inserted or detected.
 to 	LTE Network Strength	The radio is connected to an LTE network. The number of bars represents the signal strength of the LTE network.

Icon	Name	Description
	LTE No Service	The radio is not connected to an LTE network.
	Data Disabled	The radio is connected to an LTE network but the data is disabled.
	Downloading Data	Indicates the updates are downloading.
 (Top display only)	Notification	The radio receives notification of an activity or event.
	Unread Notification	Indicates there is an unread notification that requires action from the user.
	Time	Indicates the current time.
	Wi-Fi	The radio is connected to a Wi-Fi network. The number represents the signal strength of the Wi-Fi network.
		

These icons appear at the Radio Control Widget to provide information or status of LMR-specific features.

Icon	Name	Description
	Received Signal Strength Indicator (RSSI)	The number of bars represents the received signal strength of the current site in trunking mode.
	Receiving	The radio is receiving a call or data.
	Transmitting	The radio is transmitting a call or data.
	Roaming	The radio has roamed to and is registered to a foreign system.
 (Top display only)	View/Program Mode	Steady – Radio is in View mode. Blinking – Radio is in Program mode.
	Monitor (Carrier Squelch)	The selected channel is being monitored in conventional operation.
	Secure Operation	Blinking – The radio is receiving an encrypted voice call. Steady – The radio is operating in a secure channel.
	AES Secure Operation	Blinking – The radio is receiving an AES-encrypted voice call.

Icon	Name	Description
	Scan	Steady – The radio is operating in an AES-secure channel. The radio is scanning a scan list.
	Priority Channel Scan	Blinking – The radio detects activity on the designated Priority-One channel. Steady – The radio detects activity on the designated Priority-Two channel.
	Vote Scan	The Vote Scan feature is enabled.
	Direct	The radio is configured for direct radio-to-radio communication in conventional operation.
	SmartConnect	Inverted – The current channel is currently connected through the SmartConnect feature. Steady – The current channel supports SmartConnect.
	Power Level	Off – The radio is set at high power. On – The radio is set at low power.
	Zone Bank	Basic Zone Bank – Icons "A" to "F" indicates that the radio is in the dedicated zone. Enhanced Zone Bank – Icons "A" to "Y" indicates that the radio is in the dedicated zone bank.
	User Login Indicator (IP Packet Data)	Steady – The user is associated with the radio. Blinking – The device registration or user registration with the server failed due to an invalid username or pin. Inverted – The user is logged on to the secured IP packet data.
	Data Activity	Data activity is present on the radio.
	In-Call User Alert	The receiving audio turns off.

4.3.2

LED Indications

The LED indications represent the operational status of your radio. A qualified technician can permanently disable the LED indication by programming it.

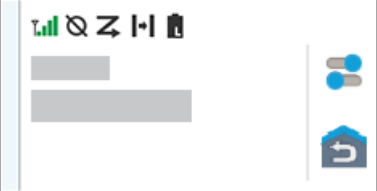

Table 7: LED Indications

Indication	Status
Solid red	Radio is transmitting.
Double blinking red	Radio is transmitting an emergency alarm or call.
Rapid blinking red	Radio has failed the self-test upon powering up or encountered a fatal error.
Solid yellow	Radio is receiving in both trunking and conventional clear mode.  NOTE: The yellow LED will illuminate only when the Busy LED feature is enabled through Customer Programming Software (CPS).
Blinking yellow	Radio is receiving a secured transmission.
Solid green	Radio is powering up.
Blinking green	Radio is receiving an individual or telephone call.

4.3.3

Transmit and Receive Indicator

The Transmit and Receive Indicator indicates the active call state of the radio.

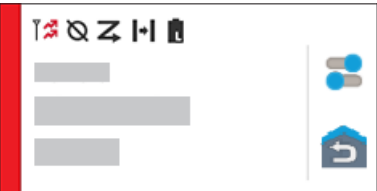
Color	Call State
Light Blue 	Open/Standby
Yellow 	Receiving and Unmuted
Red 	Voice Transmission
Gray	Unprogrammed

Color

Call State

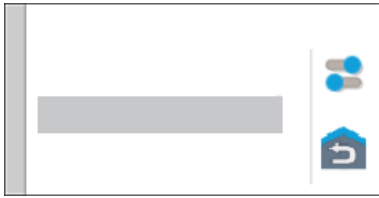

Chapter 5

General Radio Operation

This chapter explains the general operations of your radio.

5.1

Responding to Notifications

The **Notification Center** provides concise information about an activity or event.

Procedure:

1. Drag down the **Status Bar** to open the **Notification Center**.
2. Perform one of the following actions:
 - To respond to a notification, tap the assigned action message.
 - To clear all notifications, tap **Clear All**.
3. Swipe up from the bottom of the screen to close the **Notification Center**.

5.2

Managing Mode Select Menus

The Mode Select feature allows you to save the current zone and channel on your radio to one of the Mode Select feature menus (M01–M05) in the **Menu Feature Launcher** screen or a programmable side button (MS01–MS13). After that, the menus on the **Home** screen function as shortcuts to the saved zone and channel.

Prerequisites: Navigate to the zone and channel that you want to save.

Procedure:



1. From the **Home** screen, tap  **More**.
2. Perform one of the following actions:
 - To save the current zone and channel to one of the Mode Select menus, tap and hold the desired **Mode Select** menu.
 - To change to the preset zone and channel of the Mode Select menu, tap the **Mode Select** menu.

If you tap and hold the **Mode Select** menu, when the **Preconfigurable Preset Zone and Channel** field is disabled, the radio displays the `Feature not allowed` error message.

5.3

toggling the Controls and Buttons Tones On and Off

Procedure:

1. From the **Home** screen, tap  **More**.
2. To toggle the controls and buttons tones on and off, tap  **Tones**.

5.4

Control Lock

This feature allows you to lock and unlock the radio switches, buttons, knobs, and touch screen display.

5.4.1

Locking the Controls

Procedure:

- Press the pre-programmed **Control Lock** button.
The radio unlocks automatically during power cycle.

 **NOTE:** When the lock function is programmed to a switch, the switch state is detected and the lock is re-engaged automatically after the radio is rebooted.

5.5

toggling the Transmit Power Level between High and Low

This feature allows you to reduce the transmit power level for a specific case that requires a lower power level. The reduced transmit power level does not affect the receiving performance of your radio nor diminish the data functionality of the radio.

Low power level enables a shorter transmitting distance and helps conserve power. High power level enables a longer transmitting distance.

 **NOTE:** If this function is programmed to a radio switch, you are unable to change the transmit power level on the **Radio Quick Settings** menu.

Procedure:

1. From the **Home** screen, tap **Radio Quick Settings**.
2. To toggle the power level between low and high power, tap  **Low Power**.

5.6

Selecting a Radio Profile

This feature allows you to manually switch the visual and audio settings of the radio. The display, backlight, alert tones, and audio settings are defined according to the programmed radio settings of each radio profile.

Procedure:

1. From the **Home** screen, tap **More**.
2. Tap **Profiles**, then select the required profile.

5.7

General Radio Information

Use this menu item to view the general information of your radio.

The available information is:

- Radio Information
- IP Display
- SIM Status
- Control Assignments

5.7.1

Accessing the General Radio Information

Procedure:

To access the general radio information, perform one of the following:

Option	Actions
Accessing the Radio Information	<p>a. From the Home screen, tap More.</p> <p>b. Tap Info → Radio Information.</p> <ul style="list-style-type: none">• The radio shows the following information:<ul style="list-style-type: none">○ Software Version○ Host Version○ Secure Version○ Model Number○ DSP Version○ Flash Code○ Serial Number○ Codeplug Alias○ RF Band(s)○ (KG) Secure Algorithms○ MAC Address○ ESN Numbers○ IMEI/ICCID
Viewing Control Map	<p>a. From the Home screen, tap More.</p> <p>b. Tap Info → Control Map.</p>
Checking Device Status	<p>a. From the Home screen, tap System Settings.</p> <p>b. Tap My Device.</p>

Chapter 6



Zone and Channel Selection

This chapter explains the operations to select a zone or channel on your radio. A zone is a group of channels.

6.1 Selecting Zones

Procedure:

Use one of the following methods to select a zone.

Option	Actions
 ABC switch	Slide the ABC switch to the required position.
 Home screen	<ol style="list-style-type: none"> a. From the Home screen, tap the Radio Control Widget. b. Perform one of the following actions: <ol style="list-style-type: none"> i. Select Current Zone <Zone Name>, then select the required zone followed by the required channel. <div data-bbox="954 1087 1393 1243" style="border: 1px solid #ccc; padding: 5px; margin: 5px 0;">  NOTE: If the default or last known channel is configured on the radio, it automatically highlights that channel for easier selection. </div> ii. Select Recents followed by one of the recently used zones and channels.

6.2 Selecting Zones from Zone Banks

A Zone Bank consists of three zones. The Basic Zone Bank feature supports two zone banks and a total of six zones. The zones are indicated by the "A" to "F" icons. The Enhanced Zone Bank feature supports 25 zone banks, which are indicated by the "A" to "Y" icons.

Procedure:

1. To change zone banks, perform one of the following actions:
 - To change Basic Zone Banks, press the preprogrammed **Basic Zone Bank** button.
 - To change Enhanced Zone Banks, press the preprogrammed **Enhanced Zone Bank Up** or **Enhanced Zone Bank Down** button.

 **NOTE:** For the Enhanced Zone Bank feature, you can press and hold the preprogrammed **Zone Bank Up** or **Zone Bank Down** button for faster scrolling.

One of the following scenarios occur:

- For the Basic Zone Bank feature, the radio displays the icon of the selected zone.
- For the Enhanced Zone Bank feature, the radio displays the icon of the selected zone bank.



2. To change zones, change the position of the **ABC Programmable Switch**.

6.3

Selecting Channels

Procedure:

Use one of the following methods to select a channel:

Option	Actions
 ABC switch	Rotate the Channel Selector knob to the required position.
 Home screen	<ol style="list-style-type: none"> a. From the Home screen, tap the Radio Control Widget. b. Perform one of the following actions: <ol style="list-style-type: none"> i. On the Channel tab, select the required channel. ii. On the Recents tab, select the recently used zone and channel.

6.3.1

Channel Error Messages

If there is a channel error, your radio displays error messages on the Radio Control Widget.

Type	Description
Unprogrammed	The mode is set to an unprogrammed channel.
Fail 001	The selected channel is assigned to an incorrect frequency band.

Chapter 7

Dynamic Zone Programming

Dynamic Zone Programming (DZP) provides one or more Dynamic Zones to store frequently used channels for conventional or trunking. With Dynamic Zone, you can select channels from different zones without first switching to that particular zone to select a channel.



 **NOTE:** Your radio must be preprogrammed to use this feature. At least one zone in the radio must be a non-dynamic zone.

7.1

Selecting Channels in the Dynamic Zone

Procedure:

From the menu, enter a Dynamic Zone by performing one of the following options:

Option	Actions
	<ol style="list-style-type: none"> a. Slide the ABC Programmable Switch to the required position. b. Select the required channel using the Channel Selector.
	<ol style="list-style-type: none"> a. From the Home screen, tap the Radio Control Widget. b. Select the Dynamic Zone followed by the required channel.

7.2

Managing Channels in the Dynamic Zone

Prerequisites: Ensure that the Dynamic Zone Programming feature is enabled in the codeplug to be displayed in the **Menu Feature Launcher**.

Procedure:

1. Enter the Dynamic Zone by performing the following actions:
 - a. From the **Home** screen, tap the **Radio Control Widget**.
 - b. Tap the Dynamic Zone.
 - c. Tap a channel or any blank channel.
2. From the **Home** screen, tap  **More**.
3. Tap **Zone Prgm**.

4. At the **Program Zone** screen, manage channels in the Dynamic Zone by using the following options.

Option	Actions
Adding channels to the Dynamic Zone	<div style="text-align: center; margin-bottom: 10px;">  </div> <p>a. Tap the Add icon of a Blank channel.</p> <p>b. To assign a channel to the Blank channel, tap the zone and then the required channel.</p>
Replacing channels in the Dynamic Zone	<p>a. Tap the Edit icon of the channel that you want to replace.</p> <p>b. Tap Replace Channel.</p> <p>c. Tap the zone and then the required channel that you want to assign as a replacement.</p>
Deleting channels from the Dynamic Zone	<p>a. Tap the Edit icon of the channel that you want to delete.</p> <p>b. Tap Delete Channel.</p>

Chapter 8

Zone-to-Zone Cloning

Zone Cloning clones conventional zones from one radio to another.

You can select the followings zones from a source radio and clone them into a target radio.



- Clone enabled zones
- Dynamic Zones
- Multiple Private Line (MPL)

You can clone the zones by connecting the source radio and target radio with a clone cable. The target radio must be digital, band, and FCC mandate compatible with the source radio.

8.1

Cloning Zones

Procedure:

1. Connect the source radio to the target radio with a clone cable.
2. On the source radio, from the **Home** screen, tap  **More** → **Zone Cloning**.
When the source radio is connected to the target radio, a *Connected* notification appears.
3. Tap the source zone that you want to clone.
4. Tap the required target zone.
5. Tap  **Done** → **CONTINUE**.
6. Enter your authorized PIN number and tap  **Done**.

Result: If the zone cloning is successful, the display on the source radio shows a positive notification.

Chapter 9

Multiple Private Line

Multiple Private Line (MPL) is a feature that allows user to modify the PL/DPL codes of the current mode by selecting from a predefined list of codes. For the purpose of accessing different communication sub-groups, repeaters and others, user no longer need to program multiple channels of the same frequency with different PL/DPL codes.

The feature supports the following MPL selection Mode:

Table 8: MPL Selection Mode

Selection Mode	Description
Dynamic	The MPL List selection/functionality is automatically updated (and active on the radio current channel) as users scroll through the available MPL List selections.
Static	While users are scrolling through the radio available MPL List selections, MPL functionality does not change until a new MPL List is manually selected.

9.1

Selecting Multiple Private Line

Prerequisites: Ensure that this feature is enabled in the codeplug and the radio is in Conventional Mode.

Procedure:

1. Perform one of the following actions:
 - Press the programmable Multiple Private Line (MPL) Side button.
 - From the **Home** screen, tap  **More**.
2. Tap the required MPL.

The Radio Control Widget displays the selected MPL.

Chapter 10

Types of Radio Calls









Your radio can make talkgroup, private, and enhanced private calls in conventional and/or trunking mode.





Call Type	Conventional Mode	Trunking Mode	SmartConnect
Talkgroup Call A Talkgroup Call is a point-to-multipoint call operation. Your radio must be configured as a member of the talkgroup for you to communicate within the talkgroup.	✓	✓	✓
Private Call A Private Call is a call from one individual radio to another.	✗	✓	✗
Enhanced Private Call This feature allows you to send a follow up Call Alert Page immediately after a private call to a target radio is unanswered.	✗	✓	✗
Selective Call A Selective Call is a call from an individual radio to another individual radio with privacy.	✓	✗	✗
Call Alert Page Allows the radio to function like a pager, or to verify if a radio is active on the system.	✓	✓	✓

10.1 Making Calls on the Radio

Procedure:

Perform one of the following actions based on the type of radio call:

Option	Actions
Talkgroup Call	<ol style="list-style-type: none"> Ensure that you are in the preferred zone and channel. To transmit, press and hold the PTT button. Wait for the Talk Permit Tone. Then, speak into the microphone. To listen, release the PTT button. <p> NOTE: You cannot transmit longer than the preset Time-Out Timer setting. If you attempt to do so, the radio automatically stops your transmission, and you hear a negative tone.</p>
Call Alert Page	<ol style="list-style-type: none"> From the Home screen, tap  Contacts. Tap  FAB → Dialer. Enter the required number. Tap  More → Page. Tap  Page.
Private Call or Selective Call	<ol style="list-style-type: none"> From the Home screen, tap  Contacts. Tap  FAB → Dialer. Enter the required number. Tap  More → Private Call. To start the call, press the PTT button. To end the call, tap End. <p> NOTE: If Enhanced Private Call is enabled and there is no answer from the target radio, press the PTT button to send a Call Alert Page.</p>

Option	Actions
Dual Tone Multi-Frequency (DTMF) Transmission	<p>Perform one of the following actions:</p> <p>If Hot Keypad mode enabled:</p> <ol style="list-style-type: none"> From the Menu Feature Launcher, tap  <ol style="list-style-type: none"> Dialer →  More → DTMF. Press the PTT button while entering the DTMF number. <p>If DTMF Mic enabled:</p> <ol style="list-style-type: none"> From the Menu Feature Launcher, tap  <ol style="list-style-type: none"> Dialer →  More → DTMF. Enter the DTMF number.

10.2

Receiving Calls on the Radio

Procedure:

Perform one of the following actions based on the type of radio calls:

Option	Actions
Talkgroup Call	No action is required. Your radio automatically plays the transmission from the talkgroup call.
Call Alert Page	Tap Okay to accept the Call Alert Page.
Private Call or Selective Call	<p>Perform one of the following actions:</p> <ul style="list-style-type: none"> To accept the call, tap Accept. To end the call, tap End. To dismiss the call, tap Dismiss.

10.3

Making Priority Dispatch Calls

If a talkgroup is congested, the Priority Dispatch feature allows you to call the dispatcher on a different talkgroup. This talkgroup is called the Priority Talkgroup. Each trunking talkgroup can have its own assigned Priority Talkgroup. Priority Dispatch is not available during Emergency operations. Scan feature is suspended when Priority Dispatch is initiated.

Prerequisites: Dispatch console that supports this feature must be preprogrammed to use this feature. Check with your dealer or system administrator for more information on dispatch console supporting this feature.

Procedure:

1. Press the preprogrammed **Priority Dispatch** button.



NOTE: Harris' Symphony™ Dispatch Console supports this feature.

A tone sounds and the radio enters Priority Dispatch mode. The radio exits this mode when the Priority Dispatch Time Out Timer expires. The display shows **Priority Dispatch On**. Priority Talkgroup Alias also shows **Talking** when PTT is pressed.

2. Before the Priority Dispatch Time Out Timer expires, press and hold the **PTT** button to transmit.
The display shows the Priority Talkgroup alias.

3. Release the **PTT** button to listen.

The radio exits Priority Dispatch mode, returns to its original talkgroup, and displays the home channel alias.

Chapter 11

Emergency Operation

The Emergency feature is used to indicate a critical situation. An emergency signal overrides any other communication over the selected channel.

Your radio supports the following Emergency modes:

- Emergency Alarm
- Emergency Call
- Emergency Alarm with Emergency Call

One channel supports only one Emergency mode. The radio responds differently when pressing the programmed **Emergency** button in each channel.

Your radio is also programmed to operate in one of the following conditions:

Tactical/Non-Revert

The radio sends an emergency alarm and/or makes an emergency call on the current channel.

Non-Tactical/Revert for Conventional System

The radio reverts to the programmed emergency channel to send an alarm and/or make an emergency call.

Non-Tactical/Revert for Trunking System

The radio reverts to the programmed emergency talkgroup (trunking system) or channel (conventional system) to send an alarm and/or make an emergency call.

Fall Alert is an alternate way to activate the Emergency feature. For more information, see [Fall Alert on page 71](#).

For more information, contact your system administrator.

11.1

Special Considerations for Emergency Operation

The following scenarios apply during Emergency operation:

Table 9: Emergency Operation Scenarios

Scenario	Outcome
If you press the Top (Orange) button while in a channel that has no Emergency capability,	a low-pitched tone sounds.
If you change to a channel/mode with no Emergency capability while in Emergency operation,	the following occurs: <ul style="list-style-type: none"> • The display shows <code>No emergency</code>. • A continuous low-pitched tone sounds until you select a valid Emergency channel/mode or until you disable the Emergency operation.
If you change to a channel/mode with Emergency capability while in Emergency operation,	the Emergency Alarm and/or Emergency Call continues on the new channel/mode.
If the radio is out-of-range of the system or the emergency alarm is not acknowledged,	a tone sounds and the display shows <code>No ac-</code> knowledge.

11.2

Sending Emergency Alarms

This feature allows you to send a data transmission, which identifies the radio sending the emergency, to the dispatcher.

Procedure:

Press the programmed **Top (Orange)** button for emergency.

Your radio shows the following indications:

- A tone sounds
- The LED blinks red momentarily
- The radio displays *Emergency*

Result: When you receive an acknowledgment from the dispatcher (and the central controller if you are in a trunking system), your radio shows the following indications:

- A high-pitched tone sounds (Trunking only)
- The display shows *Acknowledge Received*
- Four audio tones sound
- The alarm ends
- The radio exits the Emergency Alarm mode

11.3

Sending Emergency Alarms with Emergency Calls

Procedure:

1. Press the programmed **Top (Orange)** button for emergency.
 - Your radio displays the confirmation message of a successful or unsuccessful acknowledgment from the dispatcher.
 - Your radio exits Emergency Alarm and enters the Emergency Call state.
2. Perform one of the following actions based on the type of emergency call:

Option	Actions
Emergency Call	<ol style="list-style-type: none">a. Press and hold the PTT button.b. Speak into the microphone.c. To end the transmission and wait for a response from the dispatcher, release the PTT button.

Option	Actions
Emergency Call with Hot Mic	<p>Speak into the microphone.</p> <p> NOTE: The Hot Mic applies to the first voice transmission from your radio during the Emergency call. For subsequent transmissions in the same Emergency call, you must press the PTT button.</p>

- To exit Emergency Call, see [Exiting Emergency Operation on page 63](#).

11.4

Exiting Emergency Operation

If an Emergency operation is triggered on your radio, the dispatch console or radios configured as Supervisor can exit the Emergency operation and cancel emergency mode of other radios. The dispatch console must be programmed to use this feature.

Procedure:

To exit Emergency, perform one of the following:

Option	Actions
Exiting Emergency Operation	<ol style="list-style-type: none"> From the Home screen, swipe down the Status Bar. Tap Cancel and confirm the action by tapping Yes.
Exiting Emergency as Supervisor (Trunking Only)	<ul style="list-style-type: none"> If the emergency mode is initiated by other radios, press and hold the 1-Dot (Side Middle) button, and press the Top (Orange) button. If the emergency mode is initiated by the Supervisor, perform one of the following: <ul style="list-style-type: none"> Press and hold the Top (Orange) button. Press and hold the 1-Dot (Side Middle) button, and press the Top (Orange) button. Wait for console to clear emergency. <p> NOTE: The combinations of the following buttons are supported in your radio:</p> <ul style="list-style-type: none"> Radio 1-Dot (Side Middle) and Top (Orange) buttons. Radio 1-Dot (Side Middle) and accessory Top (Orange) buttons. Accessory 1-Dot button and radio Top (Orange) button. Accessory 1-Dot button and accessory Orange button.
Exiting Emergency Via Console (Trunking Only)	<p>Radios configured as console only are not able to cancel emergency mode from the radio. The dispatch operator or supervisor must clear the emergency. Contact your system administrator for more information.</p>

11.5

Remote Emergency



The Remote Emergency feature allows you to remotely launch the emergency feature on a target radio.

You can send the Remote Emergency request to radios from recently transmitted or received calls that are stored. The latest Recent Call List refreshes automatically on your radio.

11.5.1

Sending Remote Emergency from Contacts

Procedure:

1. From the **Home** screen, tap  **Contacts**.
2. Select the required contact.
3. On the selected contact, tap and hold  **Quick Action** to open the drop-down menu.
4. Select  **Remote Emergency**.
5. To send Remote Emergency, press the **PTT** button.

Result:

If the ID of the target radio is valid, your radio displays *Sending remote emergency...* and saves the ID as the last Remote Emergency ID.

If the ID of the target radio is invalid, your radio displays an invalid ID notification.

If your radio is in one of the following states, your radio plays a tone.

- Receive-only Channel
- Transmit Inhibit
- Out of Range
- Imbalance Coverage



If your radio receives acknowledgment, your radio displays a positive notification.

If your radio does not receive acknowledgment from the target radio, your radio displays a negative notification.

11.5.2

Sending Remote Emergency from the Dialer

Procedure:

1. From the **Home** screen, tap  **Contacts**.
2. Tap  **FAB** → **Dialer**.
3. To change the call type, tap  **More** → **Remote Emergency**.
4. Enter the number of the target radio.

5. To send Remote Emergency, press the **PTT** button.

Result:

If the ID of the target radio is valid, your radio displays `Sending remote emergency...` and saves the ID as the last Remote Emergency ID.

If the ID of the target radio is invalid, your radio displays an invalid ID notification.

If your radio is in one of the following states, your radio plays a tone.

- Receive-only Channel
- Transmit Inhibit
- Out of Range
- Imbalance Coverage

If your radio receives acknowledgment, your radio displays a positive notification.

If your radio does not receive acknowledgment from the target radio, your radio displays a negative notification.

11.5.3

Sending Remote Emergency from Menu Feature Launcher

Procedure:

1. From the **Menu Feature Launcher** widget, tap  **Remote Emergency**.
Your radio displays the Call List.
2. Select the required contact.
3. To send remote emergency, press the **PTT** button.

Result:

If the ID of the target radio is valid, your radio displays `Sending remote emergency...` and saves the ID as the last Remote Emergency ID.

If the ID of the target radio is invalid, your radio displays an invalid ID notification.

If your radio is in one of the following states, your radio plays a tone.

- Receive-only Channel
- Transmit Inhibit
- Out of Range
- Imbalance Coverage

If your radio does not receive acknowledgment from the target radio, your radio displays a no-acknowledgment notification.

11.5.4

Receiving Remote Emergency

When you receive a remote emergency notification, the display shows Emergency mode and home display alternately. The receiving radio displays `Remote Emergency`.

Procedure:

1. To view notification, drag down the **Status Bar** to open the **Notification Center**.
2. To exit Emergency mode, tap **CANCEL** → **YES**.

Canceling Emergency mode dismisses Emergency notification, and your radio returns to normal operation.

Result:

If the receiving radio receives the command, the following indications occur:

- A positive indicator tone sounds.
- The display shows a positive notification.

If the receiving radio is on a channel with no emergency configured, your radio displays `No Emergency`.



NOTE: Some features are unavailable when your radio is in Emergency mode.

11.6

Emergency Keep-Alive

This feature prevents your radio from turning off when in Emergency mode. If this feature is enabled, you are required to exit Emergency mode before turning off your radio.

11.7

Emergency Beacon

When the radio is in Emergency mode, the Emergency Beacon feature transmits Bluetooth Low Energy (BTLE) signals and other Emergency information to nearby radios.

For more information, contact your system administrator.

11.7.1

Sending Emergency Beacons

When and where to use: The following method allows you to transmit the beacon.

Procedure:

Press the programmed **Top (Orange)** button for emergency.

11.7.2

Receiving Emergency Beacons

When and where to use:

The receiving radio displays `Beacon Received`, the transmitting radio Contact ID, or alias. The following methods are options on how to receive the beacon.

Procedure:

Perform one of the following:

- Tap `Details` to view the beacon list.

- Tap `Dismiss` to dismiss the beacon.



NOTE: If there are multiple beacons, the radio displays the recent beacon received.

11.7.3

Viewing Received Emergency Beacon

Procedure:

From the **Home** screen, tap  **Beacon**.



NOTE: The received beacons will be removed from the list after four minutes.

Chapter 12

Fireground

The portable Fireground Communications System is designed for deployment at an incident scene.

It consists of central components that provide on-scene and in building radio coverage, and enhanced personnel accountability and monitoring:

- Your APX portable radios
- Incident Management Software
- Command Terminal
- Radio Frequency (RF) Modem (Conventional Only)
- Control Channel Radio (Trunking)
- Optional Data Radio (Trunking)
- Accountability Server (Trunking)
- DVRS (Optional)

If you have a critical situation, you can press the **Top (Orange)** button, which activates an alarm on the Incident Management Software at the command terminal.

The command terminal receives the following status updates from your radio:

- Turning the radio on and off
- Automatic response to Polling
- Response to Evacuation commands
- Pressing the **PTT** button to make voice transmission
- Sending an Emergency Alarm and Call
- Entering or exiting a Trunking Talkgroup

12.1

Entering Fireground Zone Channel (Conventional)

Procedure:

1. Upon powering up, one of the following scenarios occurs:
 - If the Fireground Zone Channel is set as default, you hear the gurgle tone and the radio displays the home screen. You are in Fireground zone channel.
 - If the Fireground Zone Channel is set as default, but you hear a short, low-pitched tone, the display shows `REG FAIL` to indicate that the command terminal does not respond to Fireground Zone Channel. Get a qualified technician for assistance.
 - If your home channel is not Fireground Zone Channel, toggle or change the radio zone channel to Fireground Zone Channel.

If you are entering Fireground Trunking Talkgroup, upon powering up, ensure that the Fireground Trunking Talkgroup is selected. The subscriber unit automatically appears on the Incident Commander's terminal.

2. Listen for a transmission. Adjust the **Volume Control Knob** if necessary.

3. Perform one of the following actions:
 - Press and hold the preprogrammed **Volume Set** button to hear the volume set tone. Adjust the **Volume Control Knob** if necessary. Release the **Volume Set** button.
 - At the desired Fireground zone and channel, press the preprogrammed **Monitor** button and listen for activity. Adjust the **Volume Control Knob** if necessary.
 - If your radio is working in Fireground Zone Channel, proceed to next step.
4. Press and hold the **PTT** button to transmit. The LED lights up solid red while transmitting. Talk into the microphone clearly if needed.
5. Release the **PTT** button to receive.
You hear a Transmit End Tone.

12.2

Responding to Evacuation Indicator

When and where to use: The Incident Commander can trigger one of sixteen Tactical Alerts from the Command Terminal. These alerts can target individuals or groups of users within the Fireground Communication System. The ergonomic (visual and audible) response for the Tactical Alerts can be customized.

Your radio sounds the audible response at the profile maximum alert tone volume level. The display shows the configurable programmed alert text and intelligent lighting.

Procedure:

Perform one of the following actions:

- Press the radio **Top Side** button.
- Press the RSM **Side Button 1** if the radio is connected to RSM.
- Press the **PTT** button. **PTT** button must be configured in RadioCentral or Customer Programming Software (CPS) to enable this function.

The radio cancels the indications, a tone sounds and the radio sends an acknowledgment to the command terminal.



NOTE: Move the **Volume Control Knob** to adjust the volume of the audible alert from full volume.

12.3

Sending Evacuation Tone

This feature enables the evacuation tone to be heard on the transmitting radio and on any radio that is able to receive the tone instruction.

Procedure:

Press and hold the **PTT** button and then short press the **Top (Orange)** button.

Result: Once the tone begins to sound, if the orange button is released the tone continues to alarm on all radios within the talkgroup, until the **PTT** button is released.



NOTE: Radio does not transmit evacuation tone if the radio is in secure mode.

Chapter 13

Tactical Public Safety (Conventional Only)

Tactical Public Safety (TPS) enables the member of a group to identify the start and the end of a transmission by displaying the caller name or ID on the radio display.

13.1

Using TPS Normal Transmission

Procedure:

At TPS Zone Channel, perform one of the following actions:

- Press **PTT** button to transmit. Talk clearly into the microphone. Release **PTT** button to listen.
- Receive and listen to call, the radio displays the caller's name or ID.

13.2

Using TPS Emergency Transmission

The following are two important alert tones designed for this feature.

Emergency Beacon

If you press the **Top (Orange)** button during an emergency, the radio sounds a Beacon at maximum volume using the radio internal speaker (not adjustable). When pressing the **PTT** button for voice communication, the beacon is muted.

Emergency Call De-Key Sidetone

The radio sounds an alert tone to remind you that the Emergency Mode is still active after you release the **PTT** button for an Emergency call transmission. The volume of loudness depends on the maximum tone volume set in your radio profile.

Procedure:

1. Press the **Top (Orange)** button to enter Emergency Mode.
The Emergency Beacon tone sounds.
2. Press **PTT** button to make an Emergency Call.
3. Release to listen.
The Emergency Call De-Key Sidetone sounds. After a short pause, the Emergency Beacon tone sounds.
4. Press and hold the **Top (Orange)** button to exit Emergency mode and cancel Emergency Beacon.

Chapter 14

Fall Alert

Fall Alert is a supporting feature of the Emergency operation. The Emergency feature must be programmed for Fall Alert to operate.

Your radio activates the Fall Alert feature when it achieves or exceeds a tilt angle threshold or a combination of the angle threshold and radio motion below the motion sensitivity level. The radio must stay in this condition for a programmed period before the Emergency Alarm or Call is activated.



NOTE: Because Fall Alert may be triggered accidentally, consider the following scenarios when using your radio:

- If the radio is programmed to a horizontal position only, it must be worn in a vertical position.
- If the radio is programmed with the Fall Alert feature, turn off the radio when charging it with a wall-mounted charger.
- When you dismiss Fall Alert and keep the radio horizontal, no emergency will be sent and no further Fall Alert notification will occur until the device is rotated back to normal (portrait) mode.

14.1

Radio Alerts When Fall Alert is Triggered

When Fall Alert is triggered, your radio plays an alert tone, and the display shows `Fall Alert`.

Fall Alert Enhanced

Your radio also supports Fall Alert Enhanced where an alert tone is played for a programmed period. This tone is louder than the programmed minimum level or the current level of the speaker. This tone acts as a beacon to help find the radio.

When the alert tone is active, changing to another channel with a different setup triggers a different response from the radio:

- The alert tone is inhibited when you change to a channel without Emergency feature.
- The alert tone is inhibited when you change to a channel with Emergency but no Fall Alert feature.
- The current alert tone is inhibited and is replaced with a different alert tone when you change to a channel with Emergency feature and a different Fall Alert configuration.
- The alert tone continues when you change to a channel with Emergency and similar Fall Alert configuration.

14.2

Testing Fall Alert

Prerequisites: Ensure that Fall Alert feature is configured in your radio.

Procedure:

1. Turn on the radio, and place it in a vertical position for at least 5 seconds.
2. Lay the radio down in a horizontal position.

Result:

The radio plays an alert tone and the display shows `Fall Alert Detected`.

Postrequisites: If Fall Alert is configured but the condition does not trigger the activation of the feature, send the radio to a qualified technician.

14.3

Exiting Fall Alert

Procedure:

To exit Fall Alert mode, tap **Cancel**.

14.4

Reinitiating Fall Alert

Procedure:

To reinitiate Fall Alert after exiting Emergency Operation, perform one of the following actions:

- Return the radio to a vertical position.
- If motion sensitivity is enabled, shake the radio.

Chapter 15

Secure Operations

Secure radio operation provides the highest commercially available level of voice security on both trunked and conventional channels.

By default, the radio automatically enters the encrypted environment without having to manually select or clear the secure transmission.

15.1

Toggling Between Secure and Clear Transmission

Procedure:

Turn the **Secure/Clear** switch to the required position.

If the Secure/Clear selection differs from the security settings of the channel when you attempt to transmit, the **Radio Control Widget** shows `Secure Tx Only` or `Clear Tx Only`.

15.2

Multikey Feature

This feature allows the radio to be equipped with different encryption keys.

There are two types of encryption keys:

Conventional Multikey

The encryption keys are strapped on a one-per-channel basis, through CPS. In addition, you can have operator-selectable keys, operator-selectable keysets, and operator-selectable key erasure. If talkgroups are enabled in conventional, then the encryption keys are strapped to the talkgroups.

Trunked Multikey

If both conventional and trunked applications are applied, strap the encryption keys for trunking on a per-talkgroup, or announcement-group basis. Also, a different key can be strapped to other features such as dynamic regrouping, failsoft, or emergency talkgroup. You can have operator-selectable key erasure.

15.3

MDC OTAR (Conventional Only)

This feature allows you to view or define the Motorola Data Communications (MDC) Over-the-Air Rekeying (OTAR) features. It is applied only when operating in secure encrypted mode. In addition to Rekey Requests, OTAR transmissions include Delayed Acknowledgments, and Power-up Acknowledgments.

Some of the selected options require configuration at the Key Management Controller (KMC) site to work properly.





NOTE: This feature must be programmed by a qualified radio technician.

15.4

Selecting Encryption Keys (Conventional Only)

This feature allows you to change the encryption key from an active keyset.



Procedure:

1. From the **Home** screen, tap  **More**.
2. Tap  **Select Key**, then select the required encryption key.

15.5

Changing Encryption Keysets

Procedure:

1. From the **Home** screen, tap  **More**.
2. Tap  **Change Keyset**, then select the required encryption keyset.
3. Tap **Change** to confirm the request.

15.6

Infinite UKEK Retention

This feature enables Unique Key Encryption Key (UKEK) to be permanently stored in the radio even when all the encryption keys are erased. Without this UKEK key, the radio cannot be rekeyed over the air. The Infinite UKEK Retention settings can be different for each secure profile.



NOTE: This feature must be programmed by a qualified radio technician. For more information, contact your system administrator.

15.7

Requesting Rekey

Over-the-Air Rekey (OTAR), allows the system administrator to remotely reprogram encryption keys in the radio. The Rekey Request feature allows you to request for the reprogramming of the encryption keys.

Prerequisites: Ensure that at least one initial secret Unique Key Encryption Key (UKEK) has been provisioned. This secret UKEK must be established before a Rekey Request delivers the updated keys.

Procedure:

From the **Home** screen, tap  **More** →  **Request Rekey** → **Continue**.

Chapter 16

Scan





This feature allows you to monitor traffic on different channels by scanning a programmed list of channels. Scanning is halted if you initiate a call and resumes when the call has ended.

16.1

Toggling the Scan Feature On and Off

Procedure:

Perform one of the following actions:

Option	Actions
	To turn on Scan, turn the preprogrammed 2-Position Concentric switch to the scan position.
	a. From the Home screen, tap  Radio Quick Settings . b. To toggle the scan feature on and off, tap  Scan .

16.2

Making a Dynamic Priority Change (Conventional Scan Only)

While the radio is scanning, the dynamic priority change feature allows you to temporarily change any channel in a scan list (except for the Priority-One channel) to the Priority-Two channel. This change remains in effect until scan is turned off. Scan then reverts to the default setting.

Procedure:

From the **Home** screen, tap .

16.3

Deleting Nuisance Channels

If a channel continually generates unwanted calls or noise (termed “nuisance” channel), you can temporarily remove the unwanted channel from the scan list. This capability does not apply to priority channels or the designated transmit channel.

Procedure:

From the **Home** screen, tap  **Nuis Del**.

16.4

Restoring a Nuisance Channel

Procedure:

To restore the deleted nuisance channel, perform one of the following actions:

- Press the programmed **Scan** button to turn off scan and press this button again to turn on scan.
- Mode change to another channel and back to the original channel.
- Turn off the radio and then turn it on again.

Chapter 17

Scan Lists

Scan lists are created and assigned to individual channels or groups. Your radio scans for voice activity by cycling through the channel or group. The sequence of scan is as specified in the scan list for the current channel or group.

Your radio supports different types of Scan Lists:

- Conventional Scan List
- Multi-System Talkgroup Scan
- Trunking Priority Monitor Scan List

17.1

Intelligent Priority Scan

This feature allows you to add or delete conventional channels and trunking talkgroups from multiple systems into the priority scan lists.

When the radio locks onto a channel in the Intelligent Priority Scan list, the radio scans for higher priority member within the same Trunking or Conventional system.

17.2

Managing the Scan List

Procedure:

1. From the **Home** screen, tap  **Scan List**.
2. Tap **Scan List** or **Channels**.
3. Tap the required channel and perform one of the following options:
 - To assign Priority-One status to the channel, select **Priority 1**.
 - To assign Priority-Two status to the channel, select **Priority 2**.
 - To remove priority from this channel, select **No Priority**.
 - To remove the channel from the scan list, select **Remove from Scan**.
 - To add the channel to the scan list, from the **Channels** tab, select **Add to Scan List**.

Chapter 18

SmartProgramming

The SmartProgramming service enables radio programming and updates over LTE broadband connection while the radios are in use. Seamless updates of firmware (full and differential), radio configuration and security updates are scheduled by the radio system administrator and the radio user is given a choice to install immediately or delay for later.

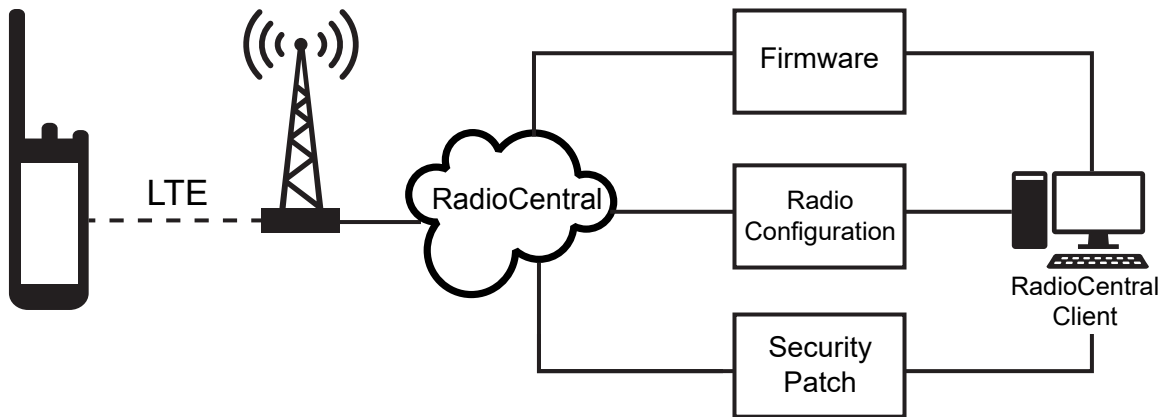

With SmartProgramming, you can apply a software feature to your radios on the go. Shortly after the purchase, the new software features license is loaded into RadioCentral or Customer Programming Software (CPS) and a provisioning job can be scheduled to enable the feature through LTE. Your radio service provider can also schedule a software update for your radio. When an update is available, your radio automatically downloads the update package. After the package is downloaded, you can install it immediately or later.

You or your service provider can reset your radio to factory settings by using this feature.

 **NOTE:** The Remote Speaker Microphone (RSM) firmware updates are carried out by the radio. Your radio will not show any notification as the updates are happening in the background.

18.1

Programming using USB for CPS

In offline situations such as emergencies or unavailable broadband connection, the Customer Programming Software (CPS) allows you to program your radio through a USB port on a local PC. You can program radios one at a time using this method.

The CPS is a proprietary Windows-based application. You can add new software and enhance features on the radio with CPS features such as drag-and-drop, clone wizard, and basic import and export functions. When loaded, radio configurations can be read and edited. You can save codeplugs and templates locally for reuse when programming other radios.

Programming your radio using CPS is the same procedure as programming any APX radios. You can refer to the *APX™ CPS Radio Management User Guide, MN003621A01* for information on programming APX radios.

 **NOTE:** Your radio firmware must be the 2021.4 or later and CPS must be R26.00.00 or later.

18.2

Firmware Update Notification Actions

Figure 4: Firmware Update Notification

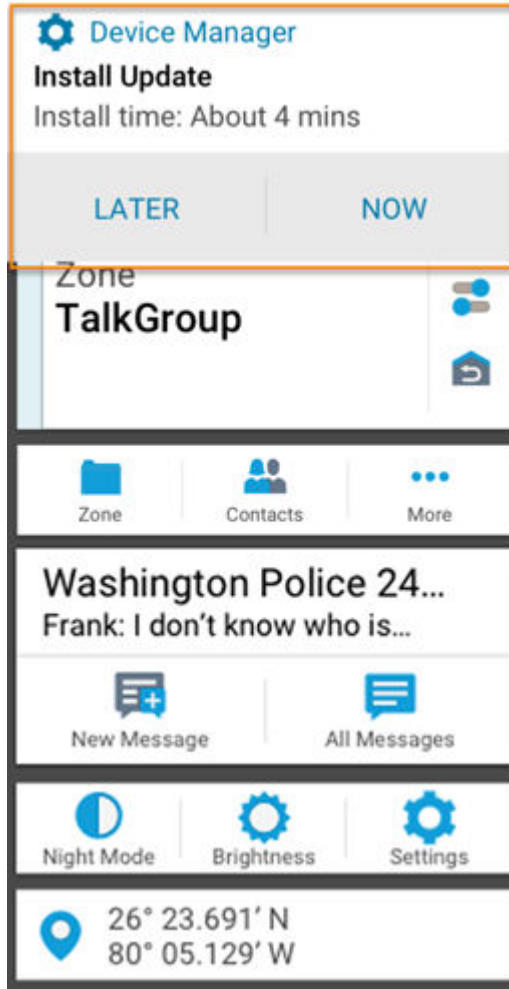

Option	Description
Later	Firmware updates on a later date.  NOTE: The firmware update notification appears each time you power up your radio.
Now	Firmware updates takes place immediately.

Chapter 19

Over-The-Air Programming (POP 25)

Over-The-Air_Programming (OTAP) allows codeplug programming over an ASTRO P25 data channel or POP 25. The codeplug of the radio can be accessed or upgraded through a wireless radio network. Full use of the radio is retained during the data transfer without interrupting communication.



IMPORTANT: Your radio firmware must be the 2023.3 or later and CPS must be R32.00.00 or later.

If the upgrade happens on ASTRO 25 and ASTRO Conventional systems, the upgrade pauses to give priority to voice calls and continues after the voice call ends.

When configuration upgrades are downloaded to your radio, you can install new changes immediately or delay the installation to the next time you turn on the radio.

19.1

Responding to Codeplug Update Notification

When your radio displays a **System Setting** dialog box that prompts you to install a codeplug update.

Procedure:

To respond to the codeplug update notification, perform one of the following actions:

- To install the update immediately, tap **Now**.
- To install the update later, tap **Later**.

Result:

If you choose to install the update immediately, the display shows `Programming Dont power off`. Your radio resets to install the upgrade.

If you choose to install the update later, the codeplug update is installed automatically the next time you turn on the radio.

Chapter 20

Connectivity

This section explains the management of connections between your radio and a variety of networks and other devices.

20.1

LTE

Your radio is set up with Long Term Evolution (LTE) broadband connection to enable Smart Programming out-of-the box, and also the SmartConnect and SmartLocate features.

In some countries, an LTE SIM may be installed into the radio by Motorola Solutions before delivery. Each preinstalled SIM is locked to the specific radio so it cannot operate in any other radio or device. The SIM is located in a slot in the rear chassis. Do not remove the SIM, even if LTE is not active or in use.

 **NOTE:** On certain occasions, the Access Point Name (APN) information needs to be edited on the device to establish connectivity with the country's SIM carrier company.

20.1.1

Editing APN Configuration

Procedure:

1. From the **Home** screen, tap  **System Settings**.
2. Tap **Advanced** → **Access Point Names**.
3. Tap **Continue** when prompted.

 **NOTE:** The fields that cannot be edited are greyed out.



20.2

SmartConnect

SmartConnect allows your radio to maintain voice communication when LMR is out of range by switching to a Wi-Fi or LTE network.

Before switching broadband connections, your radio compares the relative signal strength of the various broadband connection types to one another, as well as LMR. Your radio remains or returns to LMR when all the other broadband connections fall below the quality thresholds. SmartConnect selects Wi-Fi over LTE when both broadband connections are considered the same quality according to the SmartConnect quality threshold. Otherwise, the highest quality broadband adapter is selected. In addition, a radio operating on a lower priority broadband connection returns to the higher priority or quality connection while idle on SmartConnect.

 **NOTE:** This feature must be preprogrammed by a qualified radio technician. For more information, contact your system administrator.

Your radio displays the SmartConnect capable icon  on the SmartConnect enabled channel. When the device is connected to an available network, the radio displays SmartConnect connection icon  . Your radio displays `Out of Range` when both LMR and SmartConnect are unavailable.

20.3

Wi-Fi

You can connect your radio to a Wi-Fi network for wireless programming and SmartConnect features. Your service administrator preprograms the Wi-Fi Service Set Identifier (SSID) or network name that your radio can connect to. This feature is enabled by default on your radio.



NOTE: Channel 12 and 13 are enabled for Wi-Fi for all countries except US and Canada.

20.4

Bluetooth®

This feature allows your radio to extend its functionality by connecting to external Bluetooth accessories.



By default, Bluetooth wireless technology is activated on your radio. Your radio supports the following Bluetooth enabled devices or profiles:

- Headset (HSP)
- Personal Area Networking (PAN)
- General Attribute Profile (GATT)

20.4.1

Toggling Bluetooth On and Off



Procedure:

1. From the **Home** screen, tap  **More**.
2. Tap  **Bluetooth**.
3. To toggle Bluetooth on and off, tap **Bluetooth**.

20.4.2

Searching and Pairing the Bluetooth Device

Procedure:

1. From the **Home** screen, tap  **More**.
2. Tap  **Bluetooth**.

3. Tap  .
Your radio starts to search for nearby pairable devices.

4. Tap the name of the Bluetooth enabled device that you want to pair with, then tap **Pair**.



 **NOTE:** If the Bluetooth Pairing PIN feature is enabled, verify that the codes are correct before you begin pairing.

20.4.3

Toggling Bluetooth Audio On and Off

Bluetooth Spkr will not be available if no Bluetooth enabled audio device is connected.



Procedure:

1. From the **Home** screen, tap  **More**.
2. Tap  **Bluetooth**.
3. To toggle Bluetooth Audio on and off, tap **Bluetooth Spkr**.

20.4.4

Viewing and Clearing the Bluetooth Enabled Device Information

Procedure:

1. From the **Home** screen, tap  **More**.
2. Tap  **Bluetooth**.
3. To view the device information, tap  next to the name of the device.
4. Tap **Forget** twice, to confirm the request.

20.5

P25 Digital Vehicular Repeater System

Motorola Solutions offers an MSI Certified APX compatible, third party, P25 Digital Vehicular Repeater System (DVRS). This provides low-cost portable radio coverage in areas where only mobile radio coverage is available.

 **NOTE:** Portable subscriber units enabled in the system for Radio Authentication shall be able to authenticate regardless of whether they are communicating directly on the system or by using a DVRS.

DVRS can also work with SmartConnect to use broadband coverage for the in-vehicle mobile. Portable radios communicate through the in-vehicle mobile to the system through the LTE, Satellite, or Wi-Fi connection. This extends the system coverage when you are away from the vehicle.

20.6

Sideload Files on the Radio Using USB Cable

Procedure:

1. Connect your radio to your PC using a USB cable.
2. From the radio home screen, select **Settings** → **Advance** → **USB Connection** → **File Transfer**.
3. From your PC, click on your connected device and select **Internal Shared Storage**.
4. Upload your desired files into the appropriate folders.



NOTE: A persistent notification appears on your radio if your radio's storage has between 0%-5% left. The notification can be dismissed when your radio has 6% or more internal storage remaining.

Chapter 21

Location

The Global Navigation Satellite System (GNSS) integrates information from the Global Positioning System (GPS) and the Global Navigation Satellite System (GLONASS) to determine the approximate geographical location of your radio.

The radio also supports the following features:

Indoor Positioning

This feature allows your radio location to be tracked through Wi-Fi or cellular modem when satellite signal is unavailable. Your radio is able to continually report the current location to other radios using SmartMapping and CommandCentral Aware through SmartLocate, even when you are located indoors.



NOTE: This feature is enabled through RadioCentral or Customer Programming Software (CPS). Contact your system administrator for more information.

SmartLocate

The SmartLocate feature allows the radio to send its own location securely over broadband or LMR depending on how the radio is configured. For LMR, the radio requires a system with an Intelligent Middleware (IMW) configured along with a CommandCentral Cloud Connector.

SmartMapping

This feature allows you to view your current location and the location of other devices/units in a map or list view.

The dispatcher can always request the system to determine the real-time location of the radio.





NOTE: The Location feature is sometimes referred to as GPS in the manual, as the naming convention of the buttons and strings follows that of the legacy GPS feature.

21.1

Toggling Location On and Off

Procedure:

1. From the **Home** screen, tap  **More**.
2. To toggle location services on and off, tap  **Location**.

21.2

Viewing My Location

Procedure:

1. From the **Home** screen, tap the **Location Widget**.

2. Perform one of the following actions:

Option	Actions
If SmartMapping is enabled	Perform one of the following actions: <ul style="list-style-type: none"> • In Map view, tap My Location and tap the address. • In List view, tap the address in My Location.
If SmartMapping is disabled	Tap the address in My Location .

21.3

Waypoints

This feature shows the location coordinates and the saved waypoints on your radio. Waypoints are saved manually or automatically whenever an Emergency operation is triggered from your radio. If the Saved Waypoints list is full when Emergency operation is triggered, the radio deletes the oldest generated Emergency waypoint.

21.3.1

Managing Waypoints

Procedure:

1. From the **Home** screen, tap  **More** →  **Waypoints**.
2. Select Waypoint from the list.

Option	Actions
Deleting waypoints	<ol style="list-style-type: none"> a. Tap Delete waypoints. b. Select the waypoints that you want to delete, then tap  Delete.
Setting waypoints to the current location	By default, the radio has a HOME waypoint. It starts as an empty waypoint with no coordinates. <p>Perform one of the following actions:</p> <ul style="list-style-type: none"> • In the Map view, select the home waypoint to reset the map to the Home location. • Tap Set to current loc. → Update.

Option	Actions
Changing the location settings	<ol style="list-style-type: none"> a. Tap Location settings. b. Perform one of the following actions: <ul style="list-style-type: none"> • To change or disable the friendly location format, tap Friendly format. • To change the coordinate format, tap Coordinate format. c. Select the required format setting.











21.4

SmartMapping

This feature allows you to view your current location and the location of other devices/units in a map or list view.

Table 10: SmartMapping Icons

Icons are used in the map to provide event indications and also user functions when selected. Contact your system administrator for other icons supported on your radio.

Icon	Name	Description
	Map/List Tab	Allows you to toggle between Map and List view.
	My Location	Shows the location of your radio. Appears in gray when there is no GPS signal, internet connection, or when location is disabled.
	Zoom In/Zoom Out	Enlarges or reduces the view of the map.
	Center Location	Brings  My Location to the center of the map. Appears when  My Location is not at the map center.
	Waypoint	Indicates the waypoints saved in your radio.
	First Responder Unit	Indicates other units that are logged in to CommandCentral.
	First Responder Unit in Emergency	Indicates that the unit is in Emergency mode.
	Smartphone	Indicates other Smartphones that are logged in to CommandCentral.

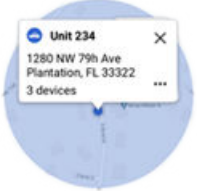
Icon	Name	Description
	Unit label	Tap a unit on the map to show dialog box and location accuracy.
	Location accuracy indicator	Indicates the confidence range for the actual location of the unit on the map.

21.4.1 Viewing Units/Devices

Procedure:



1. From the **Home** screen, tap the **Location Widget**.
2. Perform one of the following actions:
 - To view units/devices in **Map** view, tap the desired unit/device icon then tap the address.
 - To view units/devices in **List** view, tap the desired unit/device then tap the address.
3. To zoom, perform one of the following actions:
 - Tap on **+** or **-** zoom to adjust zoom levels.
 - Double tap anywhere on the map to zoom in.
 - Double tap anywhere on the map and drag your finger up or down in order to zoom in or out granularly until finger is lifted or set back to initial position.
4. To view the device details of a unit, tap the name or icon of the device.

While in Map View, a blue circle will appear behind the Unit dialog box, representing real location confidence range.

 **NOTE:** Adjusting zoom levels will change size of graphical radius and indicate exact distance on map.

5. For further details, tap the dialog box to open the **Device details** window.

While in the **Device details** menu, perform one of the following actions:

- To view the location of the device on the map, tap  **View on Map**.
- To view the contact information of the selected device, tap  **Contact Detail**.

Depending on whether the contact is saved in your radio, the radio opens the Dialer feature with or without the contact information.

 **NOTE:** All saved contacts are provisioned through the RadioCentral or Customer Programming Software (CPS).

21.4.2

Creating Waypoints in Map View

Prerequisites: To create a Waypoint, enable **Waypoints** from the filter by tapping  **More**.

 **NOTE:** Ensure that you save all the changes.

Procedure:

1. From the **Home** screen, tap the **Location Widget**.
2. From the **Map** view, long press a location on the map.

3. Tap  **Add Waypoint**.

4. Select required name, then tap  **Done**.

21.4.3

Editing Waypoints in Map View

Procedure:

1. From the **Home** screen, tap the **Location Widget**.
2. From the **Map** view, tap a waypoint then tap  **More**.
3. Use one of the following options:

Option	Actions
Setting a waypoint to the current location	Tap Set to current loc. → Update .
Deleting a waypoint	Tap Delete .

21.4.4

Managing Options in Map View

Procedure:

1. From the **Home** screen, tap the **Location Widget**.
2. Tap **Map** →  **More**.
3. Use one of the following options:

Option	Actions
Filtering and displaying group and Waypoints options	<ol style="list-style-type: none"> a. Tap Filter. b. Select the groups or Waypoints. c. Tap  Done.

Option	Actions
Changing base map	Tap Map layers → <i><required map view></i> .
Viewing Waypoints	Tap Waypoints .
Opening location settings	Tap Settings .
Viewing SmartMapping application notes	Tap About map .
Activating or deactivating clustering	Tap App Settings → Clustering → Restart .

21.4.5 Managing Options in List View

Procedure:

1. From the **Home** screen, tap the **Location Widget**.
2. Tap **List** →  **More**.
3. Use one of the following options:

Option	Actions
Filtering and displaying the group and Waypoints options	<ol style="list-style-type: none"> a. Tap Filter. b. Select the desired groups or Waypoints, then tap  Done.
Viewing Waypoints	Tap Waypoints .
Opening Location settings	Tap Settings .

Chapter 22

Mission Critical Geofence (ASTRO 25 Trunking)

This feature allows the radio to use the Global Positioning System (GPS) receiver to determine its location at frequent intervals and evaluate if the radio is within the Geofence area in real time. Geofence is a virtual perimeter based on the GPS to define a geographical area on earth.

When the radio enters the predefined Geofence area, your radio receives the Dynamic Regroup command from the system and immediately connects to a Dynamic Regroup talkgroup. The radio display shows the new selected Dynamic Regrouped talkgroup with green intelligent light for your attention. Voice Announcement is also available to support this feature.

Any new text messages received at Geofence is displayed immediately on the radio display.

**NOTE:**

If the radio is set up in Digital Vehicular Repeater System (DVRS), only mobile radio is supported for this feature.

The user navigation for this feature is not available for this model.

22.1

Entry to the Geofence Area

The Voice Announcement and Text Messaging Service (TMS) display in this feature are optional. These features must be configured to enable you to hear, and see these indicators.

When the radio enters a Geofence area, the radio immediately sends a message `ACK` back to the system.

The radio searches the current zone for the channel with same talkgroup assigned as the Dynamic Talkgroup and also with same system ID of current trunk system. Once matched, the radio display shows the first matched and connected channel alias.

If there is no channel with matching Talkgroup ID and trunk system ID, the radio display shows the channel alias of `<DYNAMIC talkgroup>`.

Once the radio is connected, you hear a dynamic regroup tone. The radio display shows `<DYNAMIC channel>`. The radio display shows the green intelligent backlight, and you hear a Voice Announcement.

**NOTE:**

When the radio loses the Global Positioning System (GPS) signal, the GPS icon blinks and the radio sounds two high-pitched tones repetitively to indicate that the GPS has failed to operate. The radio display shows the red intelligent light.

If the first matched channel is not configured with Voice Announcement, no Voice Announcement is played.

The system sends a message to your radio. The radio display shows a direct text message content without any user operation. This message indicates that you are currently present in a Geofence area. This TMS remains open on the display until you press exit or home to exit this screen.



NOTE: If there is another incoming text message before you exit the previous message, the message screen is refreshed to show the latest message.

When the radio exits the Geofence area, your radio reverts to original channel or newly assigned talkgroup. The radio display shows the new channel together with Voice Announcement to indicate the changes. Voice Announcement of the new channel only works if that channel is configured with Voice Announcement.

22.2

Entry to Mission Critical Geofence

When the radio enters the predefined Geofence area, the radio displays <Geofence Alias>. The radio display also shows the intelligent backlight, and you hear a Voice Announcement. Zone and channel alias of the Geofence area is displayed.

If the radio is set to manual, you can choose either to proceed with zone and channel change, or cancel the change.

The radio then connects to the designated talkgroup. The radio displays the talkgroup alias and dynamic regroup tone sounds. The level changes for transmit power and, your radio shows a direct text message content without any user operation.

**NOTE:**

The availability of the Voice Announcement (VA), Text Messaging Service (TMS) display, Intelligent Backlight, and Transmit Power Level alerts depend on your radio configuration. The VA can be programmed to alert continuously, or momentarily.

If Site Selectable Alert (SSA) is enabled, the radio mutes any alert that is received when entering the Geofence area, and unmutes when exiting.

22.3

Exit from Mission Critical Geofence

When the radio exits the Geofence area, the radio reverts to the original transmit power level, intelligent lighting, channel, or newly assigned talkgroup. Voice announcement (VA) is canceled or you hear a programmed VA tone. The radio displays the new channel, and a message is received to indicate the changes.

Chapter 23

Contacts

This feature provides address-book capabilities on your radio. Each entry corresponds to an alias (name) and ID (number) that you use to initiate a call. Contact entries are alphabetically sorted according to the entry alias.

Each entry within Contacts contains the following information:

- Call Alias (Name)
- Call ID (Number)
- Call Type (Icon)
- WACN ID (ASTRO 25 Trunking IDs only)
- System ID

Your radio must be programmed to allow you to add, edit, or delete the contact entries.



NOTE: Your radio is programmed with a few contacts per Call Lists. Check with your dealer or system administrator for more information.

23.1

Contacts Overview

Figure 5: Contacts Tab

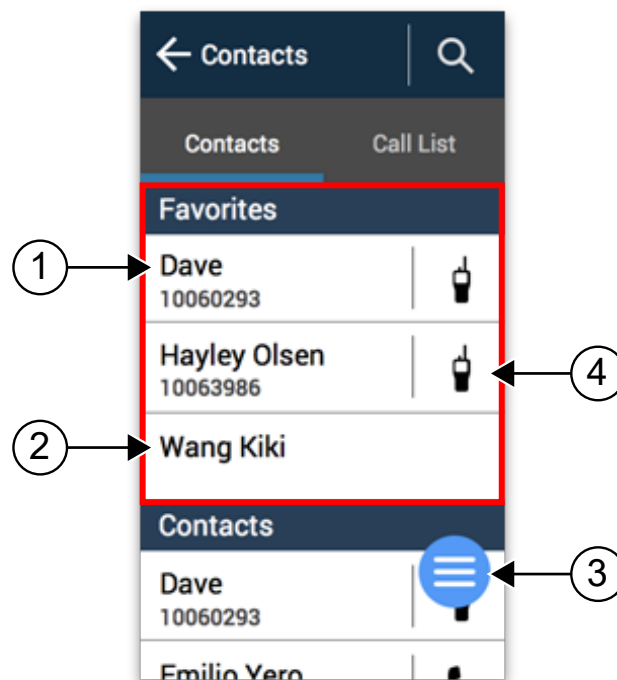

Table 11: Contacts Tab

Label	Name	Description
1	Saved Contacts	Your radio displays the numbers and names of saved contacts.
2	Favorites Contacts	Your radio displays the frequently contacted numbers or names.
3	Floating Action Button (FAB)	Allows you to access contact options.
4	Quick Action	Allows you to perform the assigned radio function.

Figure 6: Call List Tab

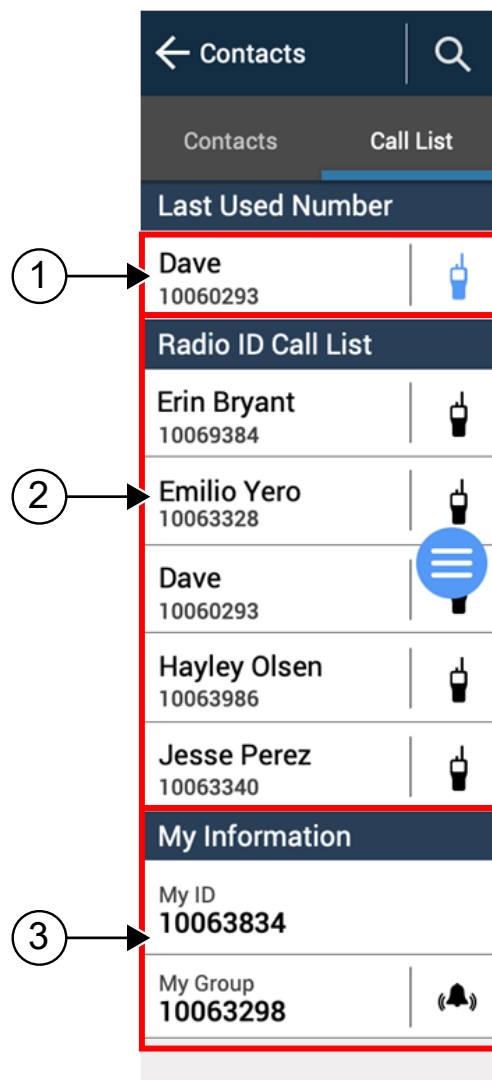

Table 12: Call List Tab

Label	Name	Description
1	Last Used Number	Your radio displays the last number received or dialed.
2	Radio ID Call List	Your radio displays the numbers and names of saved Radio ID.
3	My Information	Your radio displays your user and group number associated with the current channel.

23.2

Accessing Contacts

Procedure:

To access the contacts, use the following options:

Option	Actions
Accessing Dialer	From the Home screen, tap Contacts → FAB .
Viewing the contact details	<ol style="list-style-type: none"> From the Home screen, tap Contacts. To view the secondary information of the contact, tap <<<i>Required Contact</i>>> → Down Arrow.
Deleting the contact	<ol style="list-style-type: none"> From the Home screen, tap Contacts. To delete the contact, tap <<<i>Required Contact</i>>> → More → Delete Contact. To confirm the action, tap Delete.
Adding a contact to a Call List	<ol style="list-style-type: none"> From the Home screen, tap Contacts. To add contact to a call list, tap <<<i>Required Contact</i>>> → More → Add to Call List. Select the open slot. Tap confirm.
Editing a contact in a Call List	<ol style="list-style-type: none"> From the Home screen, tap Contacts. To edit a call list, tap <<<i>Required Contact</i>>> → More → Edit Call List. Select which number you want to edit. Select the contact you want to move. Select the new open slot.
Deleting a contact from a Call List	<ol style="list-style-type: none"> From the Home screen, tap Contacts. To edit a call list, tap <<<i>Required Contact</i>>> → More → Edit Call List. Select X beside the number you want to delete. To confirm the action, tap Remove.

Chapter 24

Recent Calls

Recent call menu allows you to view the recent incoming and outgoing call information.

You can view the information of the following type of calls:

- Emergency Calls
- Individual Calls
- Dispatch Calls



NOTE: The Log Dispatch Calls Enable field need to be enabled in RadioCentral or Customer Programming Software (CPS) for your radio to log the dispatch call.

24.1

Viewing Recent Calls

Procedure:

1. From the **Home** screen, tap **Recent Calls**.
2. To filter the calls, tap  **More** → **Filter**.
3. Select one of the following:
 - **Emergency Calls**, the result shows Emergency group calls and Emergency alarms.
 - **Individual Calls**, the result shows Call Alert (Page), Selective Calls, and Private Calls.
 - **Dispatch Calls**, the result shows Dispatch/Scan group calls.

24.2

Deleting Calls

This feature allows you to delete calls from the Recent Calls list.

Procedure:

Delete calls by using the following options:

Option	Actions
Deleting all calls	<ol style="list-style-type: none">a. Tap on the  More button.b. Select Delete Calls.c. Tap DELETE.d. Tap CONFIRM.

Option	Actions
Deleting selected calls	<ol style="list-style-type: none"> Tap on the  More button. Select Select to Delete. Select the calls to delete. Tap DELETE.

Result:

When you have successfully deleted all calls, your display shows *All entries deleted* and the Recent Calls list is empty.

When you have successfully deleted non-emergency calls, your display shows *Selected entries deleted* and the Recent Calls list only contains the remaining calls.









24.3

Accessing Instant Recall

The Instant Recall feature allows you to save and play back recent-received calls. All saved calls are removed upon radio power cycle.

Procedure:

Access the Instant Recall feature by using the following options:

Option	Actions
Playing Received Calls	<ol style="list-style-type: none"> From the Home screen, tap  More. Tap  Recents and perform one of the following actions: <ul style="list-style-type: none"> To play a recent call audio, tap  All conv. and tap the call that you want to play. The radio autoplays the audio that you have selected up to the newest received audio. To play a saved call audio, tap  Saved conv. and tap the call that you want to play. The radio autoplays the audio that you have selected up to the newest saved audio.
Saving Received Calls	<ol style="list-style-type: none"> From the Home screen, tap  More. Tap  Recents →  All conv.. Tap  Context Menu → Save all.

Chapter 25

SmartMessaging

SmartMessaging allows you to send or receive messages over a broadband connection. Messages are in the form of predefined Quick Text Messages.

The messages are synced to a server. The messages are available when you sign in from any devices or shared devices.

You are required to log in to CommandCentral to use this feature. See [Logging In to CommandCentral on page 40](#).





25.1

User Presence

This feature displays the current user status.

The status is displayed in the homescreen messages widget, All Messages screen, New Message screen and chat screen. The icon appears next to the user name to indicate the current user status.

Table 13: User Status Icons

Icon	Description
	Available
	Unavailable
	Do Not Disturb
	Unknown



25.2

Sending Quick Text Messages

Procedure:

1. From the **Home** screen, tap  **New Message**.

2. Select the recipient by using one of the following options.

Option	Actions
Sending messages to an individual	<ol style="list-style-type: none">a. From ALL, tap the required recipient from the list.b. Tap  Quick Message or Choose Text.c. Send the message by tapping the required quick message.
Sending messages to a group	<ol style="list-style-type: none">a. From GROUPS, tap the required group from the list.b. Tap  Quick Message or Choose Text.c. Send the message by tapping the required quick message.

25.3

Viewing Messages



Procedure:

1. From the **Home** screen, tap  **All Messages**.
2. Tap the required message.

25.4

Replying Messages

Procedure:

1. From the **Home** screen, tap  **All Messages**.
2. Tap the required message from the list.
3. Tap  **Quick Message** or **Choose Text**.
4. Send the reply message by tapping the required quick message.





25.5

Deleting Messages

Procedure:

1. From the **Home** screen, tap  **All Messages**.

2. Delete messages by using the following options.

Option	Actions
Deleting a Message	<ol style="list-style-type: none"> Tap and hold the required message. Tap  Delete.
Deleting More than One Message	<ol style="list-style-type: none"> Tap  More → Select to Delete. To select, tap the required messages. Tap  Delete.
Deleting All Messages	<ol style="list-style-type: none"> Tap  More → Delete All. Tap DELETE.



25.6

Accessing Multimedia Attachments

This feature is applicable for SmartMessaging only.

Procedure:

1. From the **Home** screen, tap **All Messages**.
2. Perform one of the following actions:

Option	Actions
Viewing an image attachment	<ol style="list-style-type: none"> Tap the required message with an image attachment. To zoom in and out of the image, perform one of the following actions: <ul style="list-style-type: none"> • Double tap on the image. • Tap  or .
Viewing a video attachment	<ol style="list-style-type: none"> Tap the required message with a video attachment. To play the video, tap Play.
Listening to an audio attachment	<ol style="list-style-type: none"> Tap the required message with audio attachment. To listen to the audio, tap Play.

Option	Actions
Viewing a sent location	<p>a. Tap the required message with a sent location.</p> <p>The display shows the location, and the address is updated to the friendly address.</p>
Forwarding a multimedia attachment	<p>a. Open an attachment from the selected message.</p> <p>b. Tap and hold the attachment, then tap Forward.</p> <p>c. Select the required recipient from the contact list.</p>

Chapter 26

Messages

This feature allows you to quickly send and receive messages directly from your radios. The maximum length of a text message is 200 characters. Local date and time is timestamped on the messages.



NOTE: This feature must be preprogrammed by a qualified radio technician. Check with your dealer or system administrator for more information.

26.1

Creating New Messages

Procedure:

1. From the **Home** screen, tap **New Message**.
2. Use one of the following options:

Option	Actions
If the recipient is on the User List	Tap the target user.
If the recipient is not on the User List	<ol style="list-style-type: none">a. Tap New Conversation.b. Enter the user name or ID.

3. Tap **Message Bar** to reply by using one of the canned messages.
4. To send the message, tap **Send**.

26.2

Viewing Messages

Procedure:

1. From the **Home** screen, tap **All Messages**.
2. To view message history, tap any selected conversation and view the message history in the conversation view.



26.3

Deleting Messages

Procedure:

1. Tap **All Messages**.
2. Delete messages by using one of the following options:

Option	Actions
Deleting a message	<ol style="list-style-type: none">a. Tap and hold the required message.b. Tap Delete.

Option	Actions
Deleting selected messages	<p>a. Tap  More → Select to Delete → <i><required message></i>.</p> <p>b. Tap Delete.</p>
Deleting a conversation	<p>a. Tap  More → Delete → <i><required conversation></i>.</p> <p>b. Tap Delete.</p>

Chapter 27

Voice Announcement

This feature enables the radio to audibly indicate the current feature mode, zone, or channel assigned to the user.

The available voice announcement (VA) priority options are:

High

Voice announcement is enabled even when the radio is receiving calls.

Low

Voice announcement is disabled when the radio is receiving calls.



NOTE: If the **Voice Announcement** field is set to **Enabled**, after an interruption by a momentary tone one of the following scenarios occurs:

- If **Suppress Replay** field is **Enabled**, voice announcement replays.
- If **Suppress Replay** field is **Disabled**, voice announcement turns off.

Chapter 28

Radio Inhibit

This feature allows the system administrator to put a radio into a nonfunctional state when the radio is missing or in an unknown hand. The radio stays in this state regardless of its power changes.



NOTE:

If the radio has Intersystem roaming capability, the system administrator is able to put the radio into a nonfunctional state when the missing radio roams to another system.

The radio can only be uninhibited by receiving an uninhibited command from the system administrator.

Chapter 29

Smart PTT (Conventional Only)

Smart PTT is a per-personality, programmable feature used to keep radio users from talking over other radio conversations. When Smart PTT is enabled in your radio, you cannot transmit on an active channel.

The following table shows the variations of Smart PTT.

Mode	Description
Transmit Inhibit on Busy Channel with Carrier	You cannot transmit if traffic is detected on the channel.
Transmit Inhibit on Busy Channel with Wrong Squelch Code	You cannot transmit on an active channel with a squelch code or (if secure-equipped) encryption key other than your own. If the PL code is the same as yours, the transmission is not prevented.

Chapter 30

Remote Monitor

This feature allows the system administrator to turn on the microphone of a targeted radio with a subscriber alias or ID.

When remote monitor feature is activated, the audio transmission can be configured in Customer Programming Software (CPS) to route the audio to the radio internal microphone, wired Remote Speaker Microphone (RSM), or Bluetooth wireless microphone.

In life-threatening or critical situations, the system administrator can remotely monitor any audible activity surrounding the targeted radio.

Chapter 31

Toggling between Repeater and Direct Operation

Repeater operation increases radio coverage area by connecting with other radios through a repeater. Direct or "talkaround" operation bypasses the repeater and connects directly to another radio. You can select either one of these operations on your radio.

Procedure:

1. From the **Home** screen, tap  **Radio Quick Settings**.
2. To toggle between repeater and direct operation, tap  **Direct**.

Chapter 32

Trunking System Controls

This chapter explains the trunking system control features in your radio.

32.1

Operating in Failsoft System

The failsoft system ensures continuous radio communication during a trunked system failure. When the radio goes into failsoft operation, it automatically switches to a failsoft channel which allows your radio to transmit and receive in conventional operation on a predetermined frequency.

When in failsoft operation, the radio emits a medium-pitched tone and the display shows `Failsoft`. When the trunking system returns to normal operation, your radio automatically leaves failsoft operation and returns to trunked operation.

Procedure:

If you want to communicate with other talkgroups during failsoft operation, rotate the **Channel Selector** to a different repeater frequency and press **PTT** to talk.

32.2

Imbalanced Coverage

Imbalanced coverage occurs when the radio is able to receive the control channel but is unable to transmit back to the system. The radio generates a periodic tone and displays `No Comms`.

32.3

Out-of-Range Radio

Your radio can no longer lock onto a control channel when out-of-range from the system.

When out-of-range, your radio shows the following indications:

- A tone sounds.
- The display shows the currently selected zone or channel combination, and out-of-range notification.

Your radio remains in this out-of-range condition until it locks onto a control channel or failsoft channel, or if it is turned off.

32.4

Site Trunking Feature

If the Zone Controller loses communication with any site, that site reverts to site trunking. When this occurs, you can communicate only with the radios within your trunking site.

The display shows the currently selected zone or channel, and the site trunking message.

32.5

Site Search

When searching for a site, your radio is inoperable. In the site search mode, your radio scans for trunked control channels but has yet to connect to the trunking system or reach other trunking states. Other trunking states are such as Out of Range and Imbalanced Coverage.

The *Scanning Site* indicator alerts you that your radio is attempting to search for a valid trunked control channel.

Chapter 33

Dynamic Regrouping (Trunking Only)

This feature allows the dispatcher to temporarily reassign selected radios to a particular channel to communicate with each other.

When your radio is dynamically regrouped, it receives a dynamic regrouping command and automatically switches to the dynamically regrouped channel. You hear a tone and the display shows the name of the dynamically regrouped channel.

When the dispatcher cancels dynamic regrouping, the radio automatically returns to the previous zone and channel.

If you access a zone or channel that has been reserved as a dynamically regrouped mode for other users, you hear an invalid tone.

33.1

Classification of Regrouped Radios

The dispatcher can classify regrouped radios into Select Enabled or Select Disabled categories.

Select Enabled

Select-enabled radios are free to change to any available channel, including the dynamic-regrouping channel, once you have selected the dynamic-regrouping position.

Select Disabled

Select-disabled radios cannot change channels while dynamically regrouped. The radio is forced to remain on the dynamic-regrouping channel.

The Scan and Private Call features are unavailable when your radio is Select Disabled.

33.2

Requesting a Reprogram

Procedure:

1. From the **Home** screen, tap  **More**.
2. To request a new dynamic regrouping assignment, tap  **Reprogram**.

Chapter 34

Front Panel Programming

You are able to customize certain feature parameters in Front Panel Programming (FPP) to enhance the use of your radio.

The radio can be programmed in two ways:

- Front Panel Programming (FPP) using the front panel controls of the radio.
- Customer Programming Software (CPS), with the radio connected to a PC computer.

There are two methods to program a channel within a zone. Either:

- Select the zone and channel through the radio interface, and then initiate the FPP feature. Or,
- Initiate the FPP feature, and then select the zone and channel.





NOTE: When any of the Rx parameters such as Rx frequency, Rx PL, Rx DPL, and Rx NAC is changed, FPP automatically copies these Rx parameter values to the equivalent Direct operation (also known as Talkaround operation) parameters. If you use FPP to change the Rx frequency to be the same as the Tx frequency and subsequently use the CPS to read then write to the radio, Direct/Talkaround mode will operate differently from when a receive channel parameter value is changed through FPP. Refer to the CPS help files for a description of Direct/ Talkaround Mode operation, in respect to a CPS write to the radio.

34.1

Initiating the FPP Feature

Prerequisites: Remove the universal connector seal or any other accessories attached to the radio.

Procedure:

1. From the **Menu Feature Launcher** widget, tap  **FPP**.
2. Perform one of the following actions:
 - To program zones that are not password protected and only supported in Federal FPP, tap .
 - To program a set of zones, of which one or more are password protected, enter the PIN and tap .

Result:

For the nonpassword protected choice, the radio displays `Radio Param` and `Zn/Ch Param`.

For the password protected choice, the radio requires you to enter your authorized PIN.

34.2

Changing PIN (Optional)

Prerequisites: To access the protected channels, tap **OK** when your radio prompts you to change the PIN.

Procedure:

1. Tap **FORGOT PIN** or **EDIT PIN**.

2. Enter the current PIN
3. Enter the new PIN.
4. To accept the entry, enter the new PIN again.

34.3

Editing FPP Mode Parameters

Perform the following actions as required while navigating through the mode parameters.

Procedure:

1. Scroll and select desired parameters to edit.
2. Edit the parameter values as required.

Chapter 35

Accessories

Not all accessories are FCC certified to operate with all radio models, band splits, or both. See the radio price pages for a list of FCC certified accessories or contact your sales representative for accessory compatibility.

See <https://www.motorolasolutions.com> to know more about the accessories supported by this radio.