



**MOTOROLA**

# **ASTRO® XTL™ 2500**

Digital Mobile Radio

Control Head  
User's Guide

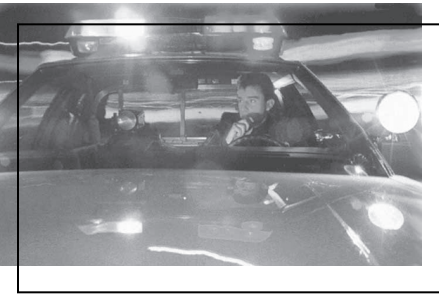



# Control Head

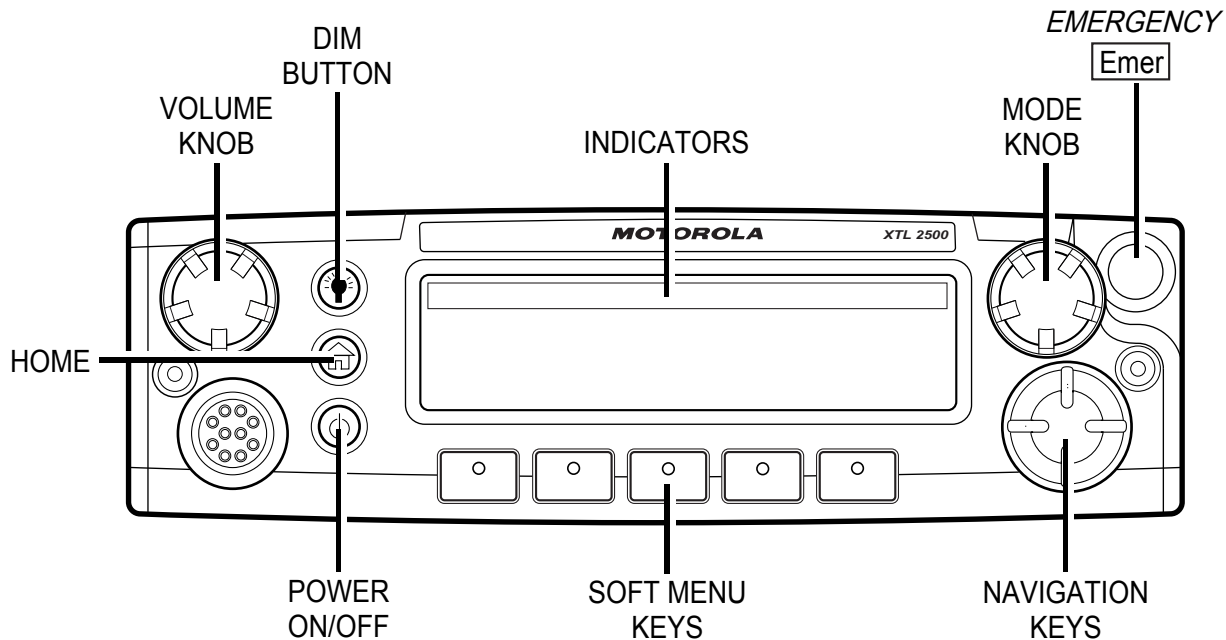



This declaration is applicable to your radio *only* if your radio is labeled with the FCC logo shown below.

## DECLARATION OF CONFORMITY

Per FCC CFR 47 Part 2 Section 2.1077(a)



Responsible Party

Name: Motorola, Inc.

Address: 1301 East Algonquin Road.  
Schaumburg, IL 60196-1078, USA  
Phone Number: 1-800-927-2744

Hereby declares that the product:

Model Name: **XTL 2500**

conforms to the following regulations:

FCC Part 15, subpart B, section 15.107(a), 15.107(d) and section 15.109(a)

### **Class B Digital Device**

As a personal computer peripheral, this device complies with Part 15 of the FCC Rules. Operation is subject to the following two conditions:

1. this device may not cause harmful interference, and
2. this device must accept any interference received, including interference that may cause undesired operation.

**Note:** This equipment has been tested and found to comply with the limits for a Class B digital device, pursuant to part 15 of the FCC Rules. These limits are designed to provide reasonable protection against harmful interference in a residential installation. This equipment generates, uses and can radiate radio frequency energy and, if not installed and used in accordance with the instructions, may cause harmful interference to radio communications. However, there is no guarantee that interference will not occur in a particular installation.

**If this equipment does cause harmful interference to radio or television reception, which can be determined by turning the equipment off and on, the user is encouraged to try to correct the interference by one or more of the following measures:**

- Reorient or relocate the receiving antenna.
- Increase the separation between the equipment and receiver.
- Connect the equipment into an outlet on a circuit different from that to which the receiver is connected.
- Consult the dealer or an experienced radio/TV technician for help.

---

## Product Safety and RF Exposure Compliance



Before using this product, read the operating instructions for safe usage contained in the Product Safety and RF Exposure booklet enclosed with your radio.

### ATTENTION!

**This radio is restricted to occupational use only to satisfy FCC RF energy exposure requirements. Before using this product, read the RF energy awareness information and operating instructions in the Product Safety and RF Exposure booklet enclosed with your radio (Motorola Publication part number 6881095C99) to ensure compliance with RF energy exposure limits.**

### Computer Software Copyrights

The Motorola products described in this manual may include copyrighted Motorola computer programs stored in semiconductor memories or other media. Laws in the United States and other countries preserve for Motorola certain exclusive rights for copyrighted computer programs, including, but not limited to, the exclusive right to copy or reproduce in any form the copyrighted computer program. Accordingly, any copyrighted Motorola computer programs contained in the Motorola products described in this manual may not be copied, reproduced, modified, reverse-engineered, or distributed in any manner without the express written permission of Motorola. Furthermore, the purchase of Motorola products shall not be deemed to grant either directly or by implication, estoppel, or otherwise, any license under the copyrights, patents or patent applications of Motorola, except for the normal non-exclusive license to use that arises by operation of law in the sale of a product.

### Documentation Copyrights

No duplication or distribution of this document or any portion thereof shall take place without the express written permission of Motorola. No part of this manual may be reproduced, distributed, or transmitted in any form or by any means, electronic or mechanical, for any purpose without the express written permission of Motorola.

### Disclaimer

The information in this document is carefully examined, and is believed to be entirely reliable. However, no responsibility is assumed for inaccuracies. Furthermore, Motorola reserves the right to make changes to any products herein to improve readability, function, or design. Motorola does not assume any liability arising out of the applications or use of any product or circuit described herein; nor does it cover any license under its patent rights, nor the rights of others.

MOTOROLA, the Stylized M Logo, ASTRO, SmartZone and FLASHport are registered in the U.S. Patent & Trademark Office. All other product or service names are the property of their respective owners. P25 radios contain technology patented by Digital Voice Systems, Inc.

© 2007, 2008, 2010 by Motorola, Inc. Printed in the U.S.A.

---

## Notations Used in This Manual

You will notice the use of WARNING, CAUTION, and Note notations throughout this manual. These notations are used to emphasize that safety hazards exist, and care that must be taken or observed.



**WARNING:** An operational procedure, practice, or other condition, which might result in injury or death if not carefully observed.



**CAUTION:** An operational procedure, practice, or other condition, which might result in damage to the equipment if not carefully observed.

**Note:** Note: An operational procedure, practice, or other condition, which is essential to emphasize.

The following special notations identify certain items:

<i>Example</i>	<i>Description</i>
Light button or 	Buttons and keys are shown in bold print or as a key symbol.
PHONE	Menu items (softkeys) are similar to the way they appear on the radio's display.

---

## **Additional Performance Enhancement**

The following are some of the latest creations designed to enhance the security, quality and efficiency of your radio.

### **Dynamic System Resilience (DSR)**

DSR ensures the radio system is seamlessly switched to a backup master site dynamically in case of system failure. DSR also provides additional indication e.g. failure detection, fault recovery, and redundancy within the system to address to the user in need. Mechanisms related to the Integrated Voice and Data (IV & D) or data centric are all supported by DSR.

### **Encrypted Integrated Data (EID)**

EID provides security encryption and authentication of IV & D data bearer service communication between the radio and the Customer Enterprise Network.



# Contents

---

<b>Control Head</b> .....	<b>i</b>
Computer Software Copyrights .....	i
Documentation Copyrights .....	i
Disclaimer .....	i
Notations Used in This Manual .....	ii
Additional Performance Enhancement .....	iii
Dynamic System Resilience (DSR) .....	iii
Encrypted Integrated Data (EID) .....	iii
<b>Introduction</b> .....	<b>1</b>
Using Your Radio: The Basics .....	1
Getting Started .....	2
Identifying Your Radio .....	4
Control Head .....	4
Operating Your Control Head .....	5
Turning On the Radio .....	5
Setting the Volume .....	6
Adjusting the Display Brightness .....	6
Using the navigation keys .....	6
Keypad Microphone Option .....	7
Trunked Modes or Conventional Channels .....	8
Field Programming .....	8
Display Status .....	8
Feature Control .....	9
Menu .....	9
Programmable Buttons .....	9
One Touch Button .....	9
Alert Tones .....	10
<b>Multiple Control Head Features</b> .....	<b>13</b>
Overview .....	13
Setting the Initial Control Head's ID .....	15
All Active Mode .....	16
One Active Mode .....	17
Intercom feature .....	19
Using the Intercom feature .....	19
<b>Basic Operating Procedures</b> .....	<b>22</b>
Basic Functions .....	22
Selecting the Zone or Mode .....	23

---

Selecting or Changing the Zone .....	23
Selecting or Changing a Mode in the Current Zone .....	24
Selecting or Changing to a Mode Not in the Current Zone .....	25
Mode Select Button .....	26
Selecting the Home Mode .....	27
Transmitting (Conventional Modes Only) .....	27
Transmitting (Trunked Modes Only) .....	28
Selecting the Transmit Power Level .....	28
Monitoring Conventional Mode Activity .....	29
Adjusting the Squelch Level .....	30
<b>General Radio Features .....</b>	<b>31</b>
Often-Used Features .....	31
Emergency Call and Alarm .....	32
Emergency Call .....	32
Initiating an Emergency Alarm .....	33
Initiating an Emergency Call .....	33
Initiating an Emergency Call and Alarm .....	34
Initiating a Silent Emergency Alarm .....	35
Special Considerations for Emergencies .....	35
Scan Operation .....	36
Turning On Scan .....	37
Turning Scan On While Disregarding the Squelch Code (Conventional Modes Only) .....	38
Viewing a Scan List .....	39
Transmitting While Scan Is On .....	40
Temporarily Deleting a Nuisance Mode with Scan On .....	41
Restoring a Nuisance Mode .....	41
Changing Mode Priorities While Scan Is On .....	42
Restoring Mode Priorities in a Scan List .....	42
Programming a Scan List .....	43
Hang Up Box (HUB) .....	45
Optional External Alarms (Horn and Lights) .....	45
Activating the External Alarm(s) .....	45
Changing the Selected Alarms .....	46
Receiving a Call While Alarms Are Turned On .....	47
Time-Out Timer .....	48
Push-To-Talk Identification (PTT-ID) .....	48
Telephone Interconnect List (Conventional and Trunking) .....	49
Answering a Phone Call .....	49

---

Initiating a Telephone Call from the List .....	50
Unlimited Telephone Interconnect .....	51
Calling a Phone Number Not in the List .....	51
Storing a Number in the List .....	52
Editing a Name in the List .....	53
Call Alert Page (Conventional and Trunking – Digital Modes Only)	56
Sending a Call Alert Page .....	56
<b>Conventional Radio Features .....</b>	<b>58</b>
Features Used in Conventional Operation .....	58
Status Calls (Digital Modes Only) .....	59
Sending a Status Call .....	59
Sending a Direct-Entry Keyboard (DEK) Status .....	61
Smart PTT .....	62
Conventional Talkgroup Calls .....	62
Digital Modes Only .....	62
Selecting a Conventional Talkgroup .....	63
Conventional Talkaround .....	64
Talk Direct (Mobile-To-Mobile) .....	64
Selective Calls (Digital Modes Only) .....	64
Answering a Selective Call .....	65
Initiating a Selective Call .....	66
Viewing Your Unit ID Number .....	68
Storing a Unit ID Number in the List .....	69
Editing a Name in the List .....	70
<b>Trunking Operation .....</b>	<b>72</b>
Features Used on Trunking Systems .....	72
Enhanced Private Conversation (Digital Modes Only) .....	73
Answering an Enhanced Private Conversation Call .....	73
Initiating an Enhanced Private Conversation Call .....	74
Failsoft .....	76
Dynamic Regrouping (Digital Modes Only) .....	77
Receiving a Dynamic Regrouping ID Assignment .....	77
Selecting Enable and Disable (Digital Modes Only) .....	78
Requesting a Dynamic Regrouping (Digital Modes Only) .....	78
SmartZone .....	80
Site-Button Operation .....	80
Locking onto a Site .....	81

---

Site Trunking .....	81
Out-of-Range Indication .....	82
Trunked Announcement .....	83
Initiating an Announcement .....	83

**ARS User Login and Text Messaging Features . . . 84**

Automatic Registration Service (ARS) .....	84
Selecting or Changing ARS Mode .....	84
ARS User Login Feature .....	86
Accessing the User Login Feature .....	86
To Login as a User .....	87
Selecting a Predefined Username .....	92
Text Messaging .....	93
Accessing TMS Feature .....	93
Receive a Message .....	98
To View Message from the Inbox. ....	98
Compose a New Text Message .....	99
Send a Predefined Message .....	103
Edit a Quick Text Message .....	104
Reply to a Received Message .....	105
Delete a Message .....	106
To Access the Draft Folder .....	107
To Access the Sent Folder .....	108

**Secure Operation . . . . . 109**

Features Available on Secure XTL 2500 .....	109
Receiving a Private Message .....	110
Transmitting a Private Message .....	110
System Considerations .....	111
Loss Indication .....	111
Selecting an Encryption Key (Conventional Only) .....	112
Selecting an Encryption Index (Conventional Only) .....	114

**Troubleshooting . . . . . 115**

**Accessories. . . . . 116**

Antennas .....	116
Bull Horns for Siren and Public Address .....	118
Cables .....	118
Microphones .....	119

---

Miscellaneous .....	119
Remote Mounting Kits .....	120
Speakers .....	120
Trunnion Kits .....	120
<b>Appendix: Maritime Radio Use in the VHF Frequency Range .....</b>	<b>121</b>
Special Channel Assignments .....	121
Emergency Channel .....	121
Non-Commercial Call Channel .....	122
Operating Frequency Requirements .....	122
<b>Glossary .....</b>	<b>125</b>
<b>Commercial Warranty and Service .....</b>	<b>128</b>
Limited Warranty .....	128
Service .....	132
<b>Index .....</b>	<b>133</b>

---

## Notes

# Introduction

---

## Using Your Radio: The Basics

This chapter gives you the basic knowledge you need in order to use your radio. The following topics are covered:

- Getting Started (page 2)
- Identifying Your Radio (page 4)
- Operating Your Control Head (page 5)
- Turning On the Radio (page 5)
- Setting the Volume (page 6)
- Adjusting the Display Brightness (page 6)
- Keypad Microphone Option (page 6)
- Display Status (page 8)
- Feature Control (page 9)
- Alert Tones (page 8)

## Getting Started

The ASTRO® XTL™ 2500 Digital Mobile Radio is among the most sophisticated two-way radios available. It can operate in the following frequency ranges:

<b>VHF</b>	<b>UHF</b>	<b>700/800 MHz</b>	<b>900 MHz</b>
136 – 174 MHz	380 – 470 MHz	762 – 776 MHz	896 – 901 MHz
	450 – 520 MHz	794 – 806 MHz	935 – 940 MHz
		806 – 825 MHz	
		851 – 870 MHz	

These channels provide maximum communications capability under varying operating conditions.

One of the newest in a long line of quality Motorola products, the ASTRO XTL 2500 Digital Mobile Radio provides improved voice quality across more of your coverage area. The digital process called *embedded signaling* intermixes system signaling information with digital voice, resulting in improved system reliability and the capability of supporting a multitude of advanced features. Such features add up to better, more cost-effective two-way radio communications.

ASTRO digital technology is also helping to provide the solution to improved spectral efficiency requiring only half as much bandwidth per channel (12.5 kHz) compared to analog technology (25/30 kHz). The net benefit to you is fewer users per channel or more users per system.

The ASTRO XTL 2500 Digital Mobile radio can include an optional RS-232 data port to interface with external devices, such as certain fax machines and laptop computers. ASTRO XTL 2500 Digital Mobile voice radios and data terminals can access the same channel without interfering with each other.



**Note:** In this manual –

*Analog mode* refers to a mode that uses traditional, non-ASTRO digital signaling.

*ASTRO mode* refers to a mode that uses ASTRO digital signaling.

Your ASTRO XTL 2500 Digital Mobile Radio utilizes Motorola's revolutionary **FLASHport**<sup>™</sup> technology. This allows your radio's capabilities to be flexible because **FLASHport** makes it possible to add software that drives these capabilities both at the time of purchase and later on. Similar to how a computer can be loaded with different software, your radio's features and capabilities can be upgraded with software.

**FLASHport** allows you to add software to your radio as your needs change and as technology advances, making your radio investment go further.

**FLASHport** is the future of radio communications, and it's yet another example of Motorola's commitment to your satisfaction.

ALL XTL 2500 radios except for the 900 MHz band are capable of both analog operation (12.5 kHz, 20 kHz and 25 kHz bandwidths) and ASTRO mode digital operation (12.5 kHz bandwidth). 900 MHz band radios are only capable of analog operation (12.5 kHz).

XTL 2500 900 MHz does not support Multi Control Head, Data and Secure features.

## Identifying Your Radio

The ASTRO XTL 2500 Digital Mobile Radio has two major components: the radio unit installed in your vehicle and the control head that is used to activate various radio features. Keep the foldout page opened for reference as you read this manual. Your radio has the following control head:

### Control Head

The control head has the rotary **Mode** and **Volume** knobs, five programmable menu buttons, a menu navigation button, and a 3-line, 14-character, fully bitmapped display (See "Control Head" on page i.).

**Note:** A "CH MISMATCH" error upon turning on your radio, means that either the Control Head has been connected to a legacy transceiver, or vice versa.

## Operating Your Control Head

Your advanced control head is designed for ease of use and flexibility of feature control. Before operating the radio, familiarize yourself with the various controls, indicators, and alert tones. Refer to the foldout diagrams in the front and back of this manual for your particular control head.

## Turning On the Radio

Basic operation is the same for all radio control heads.

Do the following:

- Turn the radio on with a short press of the power button in the lower left corner of the control unit.

After a short time, the red, green and yellow LEDs light up, indicating that the radio is powering up.

The display then shows `XTL 2500`.

When the radio is fully powered on, the Zone and Channel text and menu items is displayed. The backlight will turn on to the last selected color and dim level.

**Note:** Pressing the power button before the LEDs light up will be ignored.

Pressing the power button anytime after the LEDs light up will **TURN OFF** the radio.

**Note:** If `FAIL ##/##` appears in the display, the radio will not function until the condition has been corrected.

If `ERROR ##/##` appears, some non-critical data has been changed. If either of these displays appear, if the display goes blank, or if the unit appears to be locked up, refer to the “Troubleshooting” section.

## Setting the Volume

Rotate the **Volume** knob clockwise to increase the volume and counterclockwise to decrease the volume.

---

## Adjusting the Display Brightness

Press the dimmer button (**DIM**) to change the display brightness to one of four levels:

- Off to high
- High to medium
- Medium to low
- Low to off

In Off, both the display and backlight are off (used for surveillance operations).

---

## Using the navigation keys

When accessing a feature on the radio, use the left or right toggles on the navigation key to access further options within the menu.

If you cannot locate a menu item, it may not be programmed, or it may not apply to the radio's current mode setting.

---

## Keypad Microphone Option

If your radio is equipped with a keypad microphone, you can perform the same navigation functions from that keypad that are available on the Control Head. The keypad also enables you to use certain capabilities within features such as telephone interconnect and Selective Call. These capabilities are described in detail within the appropriate sections of this manual.

**Note:** The checkmark and X buttons on the keypad microphone are for future use and not currently used by the radio.

---

## Trunked Modes or Conventional Channels

Depending on how your radio is programmed, you can select conventional channels or trunked talkgroup. Conventional channels consist of a transmit and receive frequency pair, an associated squelch code pair, and a time-out timer value. See “Conventional Radio Features” on page 58.

Trunked modes consist of the system/announcement group/talkgroup combination and a time-out timer value. See “Trunking Operation” on page 72.

## Field Programming

Other radio features may be slaved to the selected mode by field programming. This *mode slaving* means that the radio is preprogrammed to automatically give you the proper operation for each mode you select.

You may use the control head to program your own mode names. The names you assign are clearly shown in the alphanumeric display. You can see all the key operating information, including the mode selected or being scanned, and the on/off status of various features. The operating conditions are shown either by the display or by visual/audio indicators, or by both.

## Display Status

The control head display indicates your selected mode, or the currently active receive mode when scan is on.

## Feature Control

You can turn the various radio features on or off, change modes, and adjust the volume.

To exit a feature, such as phone, press the **HOME** button.

## Menu

You can access the features supported by your radio through the Menu. To select a feature, press the soft menu key buttons below the relevant softkeys displayed.

## Programmable Buttons

Each of the five Soft Menu Key buttons and the Emergency button are programmable buttons which can be preprogrammed by a qualified radio technician to a default function which is activated upon a short press.

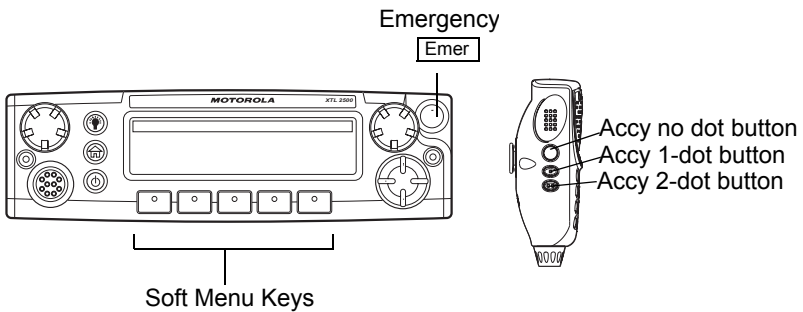

**Figure 1: Programmable Buttons on the Keypad Microphone**

## One Touch Button

Each of the five soft menu key buttons and the emergency button are programmable buttons which can be preprogrammed by a qualified radio technician to support the One Touch feature. Short press the preprogrammed One Touch button to access the One Touch Menu. Call, Page, Phone, Status and Message are commonly used features that can be assigned to this button.

**Note:** Sig 1-3 & Disp can be programmed as Soft Menu Keys to launch the One Touch features.

## Alert Tones

<i><b>Tone Type</b></i>	<i><b>Name</b></i>	<i><b>Description</b></i>
Two high-pitched tones	Private Conversation™	Indicate that a private call has been received.
Four high-pitched tones every five seconds	Call Alert	Indicate that a Call Alert page has been received.
Single, high-pitched tone	Central Acknowledge	Indicates that a Call Alert, emergency alarm, reprogram request, or status/message transmission has been received by the system's central controller.
Four high-pitched tones	Mobile Unit Acknowledge	Indicate that a Call Alert page has been received by the intended unit, or the emergency alarm, reprogram request, or status/message transmission has been acknowledged by the intended dispatcher.
Sound similar to a telephone busy signal	System Busy	Indicates, when you press the microphone push-to-talk (PTT) button, that you cannot transmit because all system radio channels are in use. Release the PTT button and wait for call back.
A series of two short, high-pitched tones	Automatic Call Back	Indicate that a channel is now available for your previously requested transmission.



<b><i>Tone Type</i></b>	<b><i>Name</i></b>	<b><i>Description</i></b>
A series of two short, high-pitched tones (same as automatic call back)	Talk Permit (optional)	Indicate, when you press the microphone PTT button, that the system is accepting your transmission.
A series of low-pitched tones followed by a series of high-pitched tones	Scan Alert On	Indicates that Scan feature is activated through the pre- programmed button.
A series of high-pitched tones followed by a series of low-pitched tones	Scan Alert Off	Indicates that Scan feature is deactivated through the pre-programmed button.
Continuous, low-pitched tone	Talk-Prohibit/ Out-of-Range	Indicates, when you press the microphone PTT button, that either you are out of the range of the trunked radio system, or the system is out of service, or the channel is busy with the Smart PTT feature enabled.
Single, high-pitched tone every nine seconds	Failsoft	In an unmuted receive condition, indicates a trunked system central controller failure. The radio reverts from trunked operation to a system similar to conventional radio repeater operation. Other system users can be heard sharing the channel.

---

<b><i>Tone Type</i></b>	<b><i>Name</i></b>	<b><i>Description</i></b>
Continuous, low-pitched tone	Illegal Mode	Indicates that you have entered a mode where normal system traffic will be missed, or you are attempting something which is not permitted. Examples include: forgetting to exit the telephone interconnect mode after a call ends (fleet and subfleet calls cannot be received), attempting to transmit on a receive-only conventional mode, attempting to select a dynamic mode where no dynamic ID assignment has been made.
Brief low-pitched tone	Time-Out Timer Warning	Indicates that your present transmission will soon be disabled.
Single, short, high-pitched tone	Valid Key	Indicates that you pressed a valid key, or you entered a feature configuration state, or you are receiving or transmitting in the clear mode on secure models (with TX Clear Alert Tones enabled).
Single, low-pitched tone	Invalid Key	Indicates that you tried to make an invalid key press, or that an emergency alarm, reprogram request, or status/message was not acknowledged.
Unique chirping sound	Dynamic Reprogramming	Indicates that a dynamic ID is assigned.
Unique, low-pitched chirping sound	New Message	Indicates the arrival of a new message.
Unique, high-pitched chirping sound	Priority message	Indicates the arrival of a priority message.

# Multiple Control Head Features

---

## Overview

The XTL 2500 Digital Mobile Radio supports transceiver control from up to two control heads. CAN cables can be connected in any configuration that does not exceed 131 feet (40 meters) in combined length. For example, each head can be connected to one of the two CAN connectors on the transceiver, or the second head can be connected to the first in a “daisy chain” configuration. Different types of microphones , i.e. palm microphone and keypad microphone, may be used in the same system. See XTL 2500 Digital Mobile Radio Control Head Installation Manual (HLN6923\_) for further information.



### CAUTION

If a keypad microphone is connected after the radio has been turned on, the radio **MAY** fail to detect it.

The Multiple Control Head feature for the XTL 2500 radio consists of two modes:

- All Active mode
- One Active mode

## Multiple Control Head Features

---

**Note:** MCH (Multiple Control Head) features can be programmed via Customer Programming Software (CPS). If two control heads are connected to the system before enabling the MCH feature in CPS, the radio will display EXTRA CH or CH ID # ERR. **Both errors are fatal.**

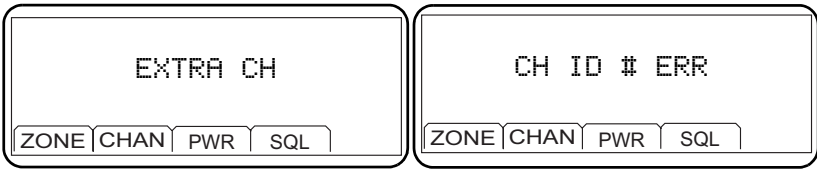

**Note:** XTL 2500 900 MHz does not support Multi Control Head features.

## Setting the Initial Control Head's ID

The Front Panel Programming (FPP) mode allows you to define which control head in a Multi Control Head system becomes control head number 1 and control head number 2.

Set the control head ID number for the second attached head the first time Multi Control Head is used.

- 1 Press the power button to power off the radio.
- 2 Press and hold the left-most  button and the emergency button on the control head simultaneously. While continuing to depress these two buttons, press the power button to power on the radio and the control head.

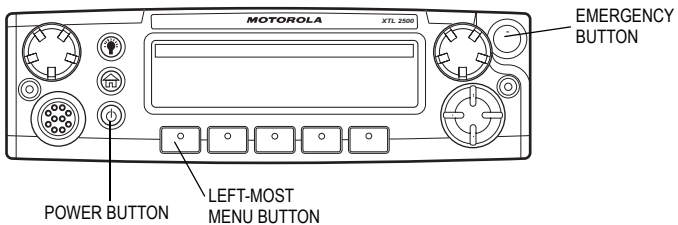

- 3 The radio and the control head will power on into FPP mode. The display shows control head's ID number.

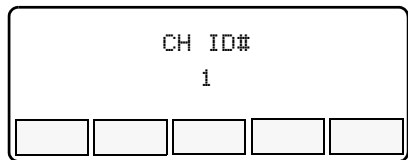

- 4 Turn the **Mode** knob to change the control head's ID number.

**Note:** In Multiple Control Head (MCH) installations, the yellow ignition wire must be connected to the head assigned ID #1.

## All Active Mode

The All Active mode enables all connected control heads of the radio to operate concurrently with each other. When a user activates a feature on one control head, the second control head will have the same activated feature and indicator on its display. The user can also deactivate a feature using any connected control head. However, each control head supports independent dim settings, volume setting, and backlight colors.

The multiple control head feature allows only control heads of the same type to be connected. Upon power up, if a control head of a different type is connected to the radio, the radio reports the fatal error CH MISMATCH on the display of all attached control heads.





CH MISMATCH

## One Active Mode

The One Active mode enables only one control head to be visibly active at a time. The active control head commands the system normally while the inactive control head displays `REMOTE`. Command can be changed between the two control heads at any time by pressing the **F/R** (Front/Rear) button. The **Volume** knob, **DIM**, **F/R**, and emergency (if programmed) buttons remain active on the inactive head, while all other controls are disabled. Emergency footswitch and VIP inputs are also still active on the inactive control head, however VIP inputs must be connected to the head assigned ID # 1. See “Setting the Initial Control Head’s ID” on page 15 for further information.

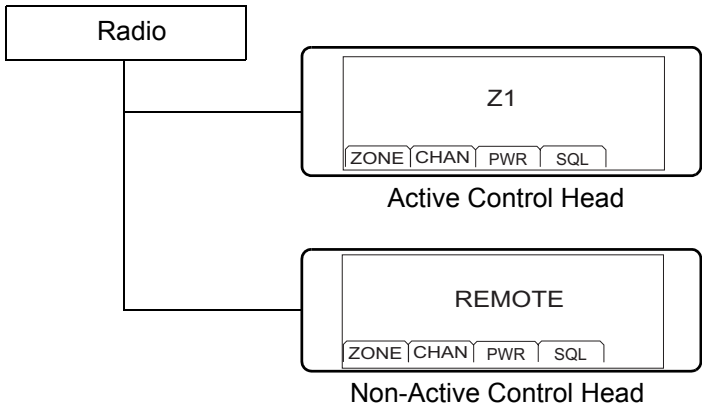
When the radio is in One Active mode, upon power up, the non-active control head displays `REMOTE`.



- 1 To change the active control head, toggle the  button below the F/R softkey.

**OR**

To change the active control head through a preprogrammed button, toggle the preprogrammed user button on the keypad microphone.

**Note:** Radio buttons that are “preprogrammed” mean that a qualified radio technician must use the radio’s programming software to assign a feature to any programmable button on the keypad microphone. See “Programmable Buttons” on page 9.

---



## Intercom feature

The intercom feature allows a user at one control head to talk to the user at the other control head of a Multiple Control Head configuration. This feature only applies to control head in the All Active mode.

### Using the Intercom feature

- 1 Press the  button directly below INTC to activate the intercom feature.

**Note:** You can activate the intercom feature on either active control head.

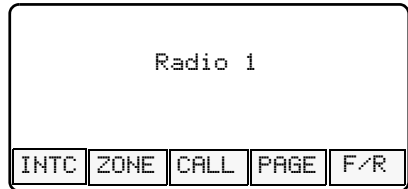

- 2 Press the  button directly below EXIT to deactivate the intercom feature.

**OR**

Press the HOME button on either control head to deactivate the intercom feature.

**Note:** The intercom feature also deactivates when user initiates a mode change. If the radio is on an emergency channel, pressing of the EMERGENCY button or the emergency footswitch button on either control head also deactivates the intercom feature.

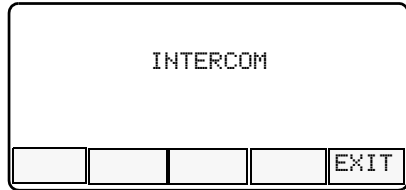

- 3 Press the microphone PTT button to initiate an intercom transmission.
- 4 The display of the control head receiving the intercom call shows the alias/ID number of the transmitting control head.

**Note:** Only one intercom call can be initiated at one time.

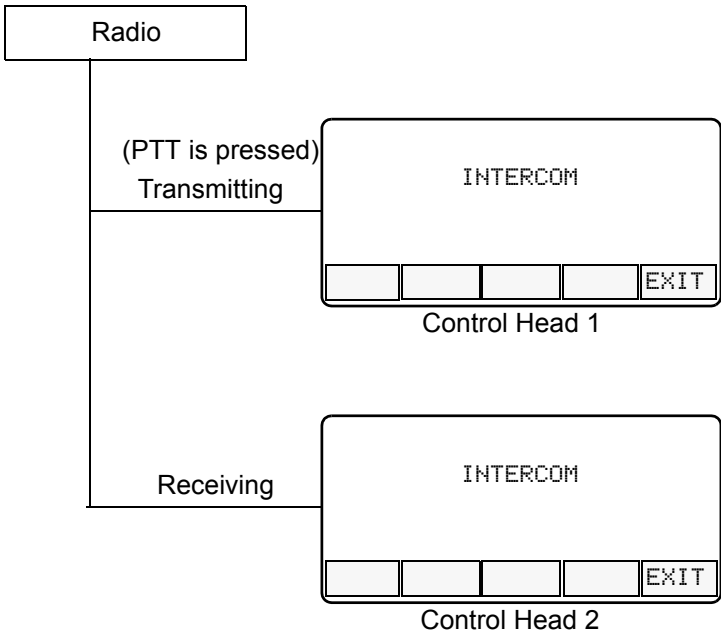

# Basic Operating Procedures

---

## Basic Functions

This chapter shows you how to access the radio's basic functions and includes the following topics:

- Selecting the Zone or Mode (page 23)
- Selecting the Home Mode (page 27)
- Transmitting (Conventional Modes Only) (page 27)
- Transmitting (Trunked Modes Only) (page 28)
- Selecting the Transmit Level (page 28)
- Monitoring Conventional Mode Activity (page 29)
- Adjusting the Squelch Level (page 30)

## Selecting the Zone or Mode

A zone is a grouping of modes. A mode is a group of characteristics such as transmit/receive frequencies, Private-Line™ codes, radio parameters, and an alphanumeric name.

### Selecting or Changing the Zone

#### Use the Menu Entry ZONE

- 1 Press the **▶** button to scroll to the **ZONE** softkey.

- 2 Press the  button below ZONE.

The display shows the current zone and mode.

- 3 Press the **▶** or **◀** until the desired zone is displayed.

- 4 Press the  or **PTT** button to save the displayed zone as the new home (default) zone.

The zone name stops flashing once it is saved.

- 5 Press the **PTT** button to begin transmitting on the displayed zone.

---

#### Use the Menu Entry ZNUP or ZNDN

- 1 Press the **▶** button to scroll to the ZNUP or ZNDN softkey.

- 2 Press and hold the  button below ZNUP or ZNDN, until the zone you want appears.

**Note:** Positions of the ZNUP or ZNDN softkey on the display may differ each time you release the  button .

- 3 Press the **PTT** button to begin transmitting on the displayed zone.



## Selecting or Changing a Mode in the Current Zone

### Use the Mode Knob

Rotate the **Mode** knob until the display shows the desired mode name.

---

### Use the Menu Entry CHAN

- 1 Press and hold  to scroll to the CHAN softkey.
- 2 Press the  below CHAN.



The display shows the current zone and mode.

- 3 Rotate the **Mode** Knob until the desired channel in the current zone is displayed.
- 4 Press the  or **PTT** button to save the displayed channel as the new home (default) channel.

The channel name stops flashing once it is saved.

- 5 Press the **PTT** button to begin transmitting on the displayed zone and mode.
- 

### Use the Menu Entry CHUP or CHDN

- 1 Press and hold  to scroll to the CHUP or CHDN softkey.
- 2 Press and hold the  below CHUP or CHDN, until the mode you want appears.

**Note:** Postions for the CHUP or CHDN softkeys on the display may differ each time you release the  button.

- 3 Press the **PTT** button to begin transmitting on the displayed zone and mode.
-

## Selecting or Changing to a Mode Not in the Current Zone

- 1 To access a mode that is not in the current zone, press the Zone up ▲ button or Zone down ▼ button to move to the zone containing the mode.

**Note:** The Zone up ▲ and Zone down ▼ buttons are optional buttons included with the radio when zone/mode is ordered.

- 2 Do one of the following:
    - Select a desired zone (page 23).
    - Select a desired mode in the current zone (page 24).
-

## Mode Select Button

This feature lets you program the current zone and channel to a **Mode Select** button with a long press on the **Mode Select** button. After the buttons are programmed, you can return to the preprogrammed zone and channel with a short press on the programmed **Mode Select** button.

The buttons on the keypad microphone that are assigned for this feature are labeled in the following picture.

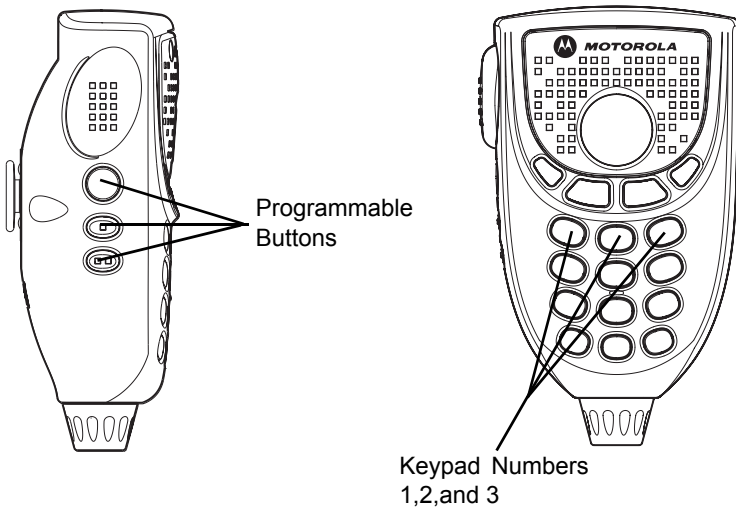

**Note:** Keypad numbers 1, 2 and 3 require the Preset Zone and Channel Enable field in the CPS to be enabled. Please check with a qualified radio technician to set them as **Mode Select** buttons.

**Note:** The orange-colored Emergency Button on the control head can also function as a **Mode Select** button.



## Selecting the Home Mode

This feature must first be enabled by a qualified radio technician.

Press the **HOME** button to select the home mode contained within the home zone, from any other zone and mode in the radio.

---

## Transmitting (Conventional Modes Only)

- 1 Lift the microphone off-hook, and listen for activity on that mode.
  - 2 If you hear no activity, press and hold the microphone **PTT** button.
-

## Transmitting (Trunked Modes Only)

- 1 Lift the microphone off-hook, and press the microphone **PTT** button.
- 2 Do one of the following:
  - If you hear three quick tones, or if you hear no tone and the red **XMIT** (transmit) indicator lights steadily, then proceed with your message.

Release the **PTT** button to receive.

### OR

- If you hear a continuous low-pitched tone, you are out of the system's range.

The display area may indicate “**OUT OF RANGE**” in the text display area.

The red **XMIT** indicator may flash several times as the radio tries to access the system.

Release the **PTT** button and try again when the vehicle is driven within range of the system.

---

## Selecting the Transmit Power Level

The **PWR** softkey lets you select (toggle) the transmit power level.

Press the **PWR** softkey.

The display momentarily shows **POWER LOW** or **POWER HIGH** to indicate the transmit power level selected.

---

## Monitoring Conventional Mode Activity

This feature allows you to monitor channel traffic on conventional channels by defeating the coded squelch. This feature must first be enabled by a qualified radio technician or system administrator.

Do one of the following:

Take the microphone off hook.

(This is the same as monitor on. You hear all channel traffic.)

### OR

- 1 Make sure you are in Home mode where the default zone and mode are being displayed (page 27).
  - 2 Press the ► or ◀ button to scroll to the MON softkey.
  - 3 Pressing MON softkey momentarily toggles between MONITOR ON and MONITOR OFF. MONITOR ON shown on the display indicates that the radio is monitoring.
  - 4 Pressing MON softkey again turns monitor off and you do not hear all channel traffic.
-

## Adjusting the Squelch Level

Your radio's ability to transmit or receive signals varies as you move away from or close to your base station. You can adjust your radio's squelch to improve its ability to receive transmissions.

Do the following:

**1** Press the **▶** or **◀** button to scroll to the **MON** softkey.

- Press and hold the  button below **MON**.

The display shows **SQUELCH XX**, where **XX** is a squelch level setting of **0** to **15**.

**2** Press the  button to return to the selected channel.

---

# General Radio Features

---

## Often-Used Features

This chapter shows you how to access the most frequently used features. The following topics are covered:

- Emergency Call and Alarm (page 32)
- Scan Operation (page 36)
- Optional External Alarms (Horn and Lights) (page 45)
- Time-Out Timer (page 48)
- Push-To-Talk Identification (PTT-ID) (page 48)
- Telephone Interconnect List (Conventional and Trunking) (page 49)
- Unlimited Telephone Interconnect (page 51)
- Call Alert Page (Conventional and Trunking – Digital Modes Only) (page 56)

## **Emergency Call and Alarm**

The emergency call and alarm features allow you to have priority channel access and/or send an emergency data transmission to the dispatcher in an emergency situation.

The desired type of emergency feature – alarm, call, call and alarm, or silent alarm – can be preprogrammed by a qualified radio technician.

The radio must be turned on to activate any emergency feature.

### **Emergency Call**

Emergency call gives you priority access to a voice channel for all subsequent transmissions after you press the emergency button. The level of priority access is determined by the system manager.

#### **SmartZone Emergency Call Receive Operation**

A radio configured for SmartZone<sup>®</sup> operation displays `EMER RECEIVED` whenever it receives an emergency call. The display alternates with the selected-mode display as long as the radio is unmuted to the emergency call.

## Initiating an Emergency Alarm

The emergency alarm feature sends a data transmission to alert the dispatcher of your emergency condition and identify your unit ID.

Press the emergency button.

A tone sounds and the display alternates **EMERGENCY** with the current zone/channel.

**For trunking modes**, a high-pitched tone indicates that the alarm has been received by the trunked system's central controller.

A dispatcher acknowledgment **ACK RECEIVED** display follows.

The radio automatically returns to normal operation. No further action is required.

---

## Initiating an Emergency Call

- 1 Press the emergency button.

A tone sounds and the display alternates **EMERGENCY** with the current zone/channel.

- 2 Press the **PTT** button and announce your emergency.
- 3 After completing the emergency call, press and hold the emergency button until a tone sounds.

The alternating **EMERGENCY** display disappears, and the radio returns to normal operation.

---

## Initiating an Emergency Call and Alarm

If the radio has both emergency call and alarm features, it automatically proceeds to the call mode after the alarm is acknowledged.

- 1 Press the emergency button to activate the emergency call/ alarm feature.

The display begins alternating EMERGENCY with the current zone/channel.

**For trunking modes**, a high-pitched tone sounds, indicating that the alarm has been received by the trunked system's central controller.

A dispatcher acknowledgment (four high-pitched tones) follows, accompanied by an ACK RCVD display.

- 2 Press the **PTT** button and announce your emergency.
- 3 To exit from the emergency state altogether, press and hold the emergency button until a tone sounds.

The alternating EMERGENCY display disappears, and the radio returns to normal operation.

**Note:** Turning the radio off also cancels the emergency state.

---



## Initiating a Silent Emergency Alarm

- 1 Press the emergency button to activate the silent alarm feature.

During a silent emergency alarm, there are no display changes, and the receiver audio mutes so that no indication is given that an emergency alarm has been sent.

- 2 To exit the silent alarm mode, press and hold the emergency button until a tone sounds.

**Note:** If silent emergency alarm is used with emergency call, pressing the **PTT** button exits the silent mode and initiates the emergency call.

---

## Special Considerations for Emergencies

- If you press the emergency button while in a mode that has no emergency capability, a low-pitched tone sounds.
- If the unit is out of the range of the system and/or the emergency alarm is not acknowledged, a tone sounds and the display shows `NO ACKNOWLEDGE`.
- If you press the emergency button, then change to a mode that has no emergency capability, a `NO EMERGENCY` display alternates with the mode name display, and a continuous low-pitched tone sounds until a valid emergency mode is selected or until the emergency is cancelled.
- When an emergency is active, changing to another mode where emergency is enabled (trunked or conventional) causes an emergency alarm and/or emergency call to be active on the new mode.

## Scan Operation

The scan feature allows you to monitor activity on different conventional or trunked modes by scanning a *scan list* of modes. The modes to be scanned in a scan list are programmed by a qualified radio technician. You can select the modes to be scanned in a scan list if *operator-selectable scan* is enabled.

There are three types of scan lists available:

- Conventional – Comprises up to 15 different conventional-only modes
- Trunked Priority Monitor – Comprises up to 15 modes that are all from the same trunked system
- Talkgroup Scan – Comprises up to 10 combined conventional modes and modes from one trunking system

The radio supports both priority and non-priority scanning. With priority scanning enabled, a scan list can have one mode assigned as the first-priority mode and a second as the second-priority mode.

The XTL 2500 Digital Mobile Radio supports automatic scanning (autoscan), which can be programmed into the radio by a qualified radio technician. With this feature, the radio begins scanning whenever you select a mode to which a scan list is assigned.

**Note:** You cannot turn scan off on a mode that has autoscan enabled.

If multiple scan types are enabled in the radio, the type of scan that is activated depends on the personality of the mode selected when the **SCAN** softkey is pressed. For all types of scan, the selected mode is, by default, a member of its own scan list.

Scan lists stay in memory when you turn scan off, turn the radio off, or disconnect the radio from the battery.

## Turning On Scan

Do the following:

- 1 Press the **▶** button to scroll to the **SCAN** softkey.
- 2 Press the  button below **SCAN**.

The **Scan** indicator lights and a list of modes is scanned for activity. The text display area will indicate **SCAN ON** if scan is currently enabled or **SCAN OFF** if scan is just been turned off.

When a scanned mode becomes active, the display changes to show the active mode name, the appropriate priority indicator lights, and the radio unmutes.

The radio will not begin scanning again for a predetermined *hang time* after the call ends, giving you time to respond. The hang time is typically three seconds (by default), but can be changed by a qualified radio technician.

**Note:** A lit **N PRI** (non-priority) indicator means that the active mode is a non-priority member of the scan list (for all scan types).



A solidly-lit **PRI** (priority) indicator means that the active mode is the priority 2 member of the scan list (Trunking Priority Monitor and Conventional scan types only).

A blinking **PRI** indicator means that the active mode is the priority 1 member of the scan list (Trunking Priority Monitor and Conventional scan types only).

---

## Turning Scan On While Disregarding the Squelch Code (Conventional Modes Only)

Do the following:

- 1 Press the  button to scroll to the MON softkey.
- 2 Press the  button below MON.
- 3 The brief MONITOR ON display indicates that the radio is disregarding the squelch code.

**Note:** While scanning for activity, you can still receive fleetwide, system-wide, dynamic regrouping, incoming telephone interconnect and Private Conversation/Call Alert calls.



Respond to these types of calls as you would normally on the selected mode. However, when scanning different modes while in talkgroup scan, incoming Private Conversation/Call Alert calls may be missed.

---

## Viewing a Scan List

- 1 Press and hold the **SCAN** softkey until the **Scan** indicator blinks and a beep is heard.

The radio suspends scanning while a scan list is being reviewed.

- 2 Press the **▶** button to scroll to the **VIEW** softkey.
- 3 Press the  button below **VIEW**.
- 4 Press the **▶** button to scroll to the **SCAN** softkey.
- 5 Press the  button below **SCAN**. The radio suspends scanning while a scan list is being reviewed.
- 6 Press the **▶** or **◀** button to scroll through the preprogrammed scan list.
- 7 Those modes that are in the scan list are indicated by **N PRI**, **PRI** or blinking **PRI** indicator (indicating the mode's assigned priority as previously described).
- 8 Press **RCL** softkey to review only modes that are already in the scan list.

Press the **HOME** button momentarily to exit the scan list and resume scanning.

---

## Transmitting While Scan Is On

### Radio Programmed for Talkback Scan

Press the microphone **PTT** button to transmit on the mode indicated by the display.

The radio does not begin scanning again for a predetermined hang time (programmable by a qualified radio technician) after you release the **PTT** button, allowing the other party to respond.

If the other party responds within the hang time, scanning does not resume until the full hang time expires after they have finished speaking, allowing the conversation to be completed.

**Note:** To transmit on the selected channel if another channel is active, first turn scan off by pressing the **SCAN** softkey momentarily.

---

### Radio Programmed for Non-Talkback Scan

In selected mode or fixed mode, press the microphone **PTT** button at any time to transmit on the selected mode or fixed mode.

**Note:** To make a Call Alert page, or Private Conversation call while scanning, press either the **PAGE** or **CALL** softkey. The call is entered on the selected mode and scanning is halted until the call is exited by pressing the **HOME** button or pressing either the **PAGE** or **CALL** softkey.

---

## Temporarily Deleting a Nuisance Mode with Scan On

To temporarily delete a mode that you do not wish to hear (nuisance mode), press **NUIS** softkey by searching for it with the help of **▶** or **◀**.

You can delete undesired modes.

**Note:** Priority modes, the selected mode, and the designated transmit mode cannot be deleted.

---

## Restoring a Nuisance Mode

To restore the original scan list, do one of the following:

- Turn scan off, then on.
- Change modes.
- Turn off the radio, and then turn it back on.

**Note:** Nuisance mode delete can be disabled by the system administrator.

---

## Changing Mode Priorities While Scan Is On

When active, this dynamic priority feature allows you to change the priority of a non-priority mode in the scan list to priority 2.

- 1 Press **DYNP** softkey to change the priority of a non-priority channel in the scan list to priority 2.
- 2 Press the **HOME** button momentarily to exit the scan list and resume scanning.

You cannot alter the status of the priority 1 member.

---

## Restoring Mode Priorities in a Scan List

To restore the original mode priorities in a scan list, do one of the following:



- Press the **RCL** softkey.
  - Turn scan off, then on.
  - Change modes.
  - Turn off the radio, and then turn it back on.
-



## Programming a Scan List

To program a scan list, operator-selectable scan list members first must be enabled in the radio programming by a qualified radio technician.

### Adding a Channel to the Scan List

- 1 Press the **▶** button to scroll to the **PROG** softkey.
- 2 Press the  button below **PROG**.
- 3 Press the **▶** button to scroll to the **SCAN** softkey.
- 4 Press  button below **SCAN**. The scan indicator blinks and a good-key chirp is heard.
- 5 Press the **▶** or **◀** button to scroll through the preprogrammed scan list.

Press the **SEL** softkey to add the channel.

Scroll through of the available priority choices, and press the **SEL** softkey to choose one.

The new channel becomes a member of the scan list assigned to the selected channel when scan list programming was entered.



**Note:** If a scan list is full, you will hear a bad-key chirp each time you press **SEL** softkey, and the desired channel will not be assigned to the list.

Press the **HOME** button to exit scan list programming and return to normal scan operation.

---

## Deleting a Channel from the Scan List

Do the following:

- 1 Press the **▶** button to scroll to the **PROG** softkey.
- 2 Press the  button below **PROG**.
- 3 Press the **▶** button to scroll to the **SCAN** softkey.
- 4 Press  button below **SCAN**. The scan indicator blinks and a good-key chirp is heard.
- 5 Press the **▶** or **◀** button or rotate the **Mode** knob to locate the channel to be deleted.

Press the **SEL** softkey momentarily to scroll through the available priority choices until the priority choice disappears.

This indicates that the channel is no longer a member of the scan list that was assigned to the selected channel.

### OR

Press the **RCL** softkey momentarily to scroll through just the scan list members.

### OR

Delete a channel from a scan list by pressing **DEL** softkey.

**Note:** If you delete all members of a scan list, and scan is subsequently turned on, you will hear a continuous low-pitched tone, and the display will change to **EMPTY LIST**

You cannot delete the designated transmit mode, the selected mode, or the fixed scan list members. The selected mode, by default, is always scanned when scan is turned on, regardless of whether or not it is explicitly programmed as a scan list member.

Press the **HOME** button to exit scan list programming and return to normal scan operation.

---

## Hang Up Box (HUB)

To temporarily suspend Scan Mode operation, remove the microphone from the Hang Up Box (HUB). You are allowed to use the microphone while scan is suspended. Priority Member scanning is **not** suspended, however. This feature applies to all Scan Lists and Scan Types. Scan is resumed once the microphone is returned to the holding clip and the preprogrammed hang time has elapsed.

**Note:** Priority Scan List members are continuously scanned only when the Scan List, **Designated Tx Member** field is set to "Talkback" in the radio programming. Otherwise, all scan mode operation is suspended.

## Optional External Alarms (Horn and Lights)

All control heads can be equipped for external alarms (horn and lights) that are activated when a Call Alert page, Private Conversation call, or phone call is received.

These features are useful when you must leave the vehicle, but need to receive any incoming messages.

The radio always powers up with the horn and lights feature enabled.

## Activating the External Alarm(s)

### Non-Permanent Horn and Lights

- 1 Press the H/L softkey momentarily.  
If necessary use the ► or ◀ buttons to access other options within the menu.

The last selected alarm(s) is enabled, and the display alternately shows the enabled alarm(s), then the selected mode.

- 2 Press the H/L softkey a second time to turn off the alarm(s).
-

## Permanent Horn and Lights

- 1 Press H/L softkey momentarily.

The last selected alarm(s) is enabled.

The display briefly shows the enabled alarms, and then reverts back to the selected mode.

- 2 Press the H/L softkey a second time to turn off the alarm(s).
- 

## Changing the Selected Alarms

- 1 Press the H/L softkey until a tone sounds and the display indicates the currently selected alarm.
  - 2 Press the appropriate softkey right below the menu to review the choices until the display shows the desired alarm:
    - H/L softkey - HORN/LITES ON (both horn and lights)
    - LGTS softkey - LIGHTS ON
    - HORN softkey - HORN ON
  - 3 Press the H/L softkey to select the desired alarm and return to normal operation.
-

## Receiving a Call While Alarms Are Turned On

When a call is received, the vehicle's horn sounds for four seconds, and/or the car lights turn on for 60 seconds. The time interval can be modified by a qualified radio technician.

The display alternates between the type of call received (**CALL**, **PAGE**, or **PHONE**) and the selected mode name.

### Turning Off Non-Rearmable External Alarm

- 1 To turn off the external alarm(s), press the **PTT** button or any control-head button.

**Note:** Pressing the **CALL**, **PAGE**, or **PHON** softkey will turn off the external alarm(s) and place you directly in that feature.

The **Volume** knob and the **DIM** button have no effect on the state of the external alarm(s).

- 2 To rearm the horn and lights feature, press the **H/L** softkey momentarily.
- 

### Turning Off Rearmable External Alarms

To turn off the external alarm(s), press the **PTT** button or any control head softkey or button other than the **H/L** softkey.

Pressing **CALL**, **PAGE**, or **PHON** softkey turns off the external alarm(s) and places you directly in that feature. When the external alarm(s) are turned off, they will be automatically rearmed.

**Note:** Pressing the **H/L** softkey turns off the external alarm(s) and exits the horn and lights feature. To re-arm the feature, press the **H/L** softkey momentarily.

The **Volume** knob and the **DIM** have no effect on the state of the external alarms.

---

## Time-Out Timer

All ASTRO XTL 2500 Digital Mobile Radios provide a time-out timer function that prevents locking up a repeater or channel by prolonged keying of the transmitter. You cannot transmit longer than the preset timer setting. If you attempt to do so, the radio automatically stops your transmission, and you hear a talk-prohibit tone.

**Note:** You will hear a brief, low-pitched, warning tone four seconds before the transmission times out.

The timer is set for 60 seconds at the factory, but it can be reprogrammed by a qualified radio technician for between 15 and 465 seconds (7.75 minutes), in 15-second intervals, or it can be disabled entirely for each radio mode.

## Push-To-Talk Identification (PTT-ID)

When you press the PTT button to send a message, your radio ID number is transmitted as part of each voice message. This PTT-ID number is then shown on the receiving radio's display.

For the digital mode, the display shows up to eight right-justified digits.

Pressing the **CALL** softkey erases the PTT-ID from the display.

The display conditions of PTT-ID must be programmed by a qualified radio technician.

## Telephone Interconnect List (Conventional and Trunking)

With any of the control heads, you can initiate and receive telephone calls if the system is properly equipped. All calls between the mobile operator and the land line are private, regardless of who initiates the call.

All control heads feature a phone list capability of up to 100 preprogrammed phone numbers. The radios can be programmed by a qualified radio technician so that a name can be assigned to each number in the list.

### Answering a Phone Call

When a phone call is received, telephone-type ringing sounds and the display shows `PHONE CALL`.

- 1 Press the `PHON` softkey.
  - 2 Press the **PTT** button to talk; release it to listen.
  - 3 When the call is completed, press the **HOME** button or `PHON` softkey to hang up and return to normal operation.
-

## Initiating a Telephone Call from the List

- 1 Press the **PHON** softkey momentarily to select the phone function.

A valid-key chirp is heard.

The display shows the last number dialed or a blank scratchpad appearing as a series of dashes.

- 2 Press the **▶** or **◀** button to locate the number you want to call.

The display first shows the name, and then the number.

- 3 Press the **PTT** button.

The display shows the number that is automatically dialed.

**Note:** If the number contains a programmed pause, the dialing pauses briefly when the display shows **F**. After the brief pause, the rest of the numbers are dialed.

If you are out of range of the trunked system, the display shows **NO PHONE**, and a continuous low-pitched tone sounds. Press the **PHON** softkey to resume normal operation.

If the trunked phone interconnect is in use or the phone interconnect is out of service, a telephone-type busy tone sounds, and the display shows **PHONE BUSY**. Your number is automatically dialed when the phone interconnect becomes available. If you hang up, you lose your place in the queue.

If the display shows **PHONE BUSY** with a low-pitched tone rather than a telephone-type busy tone, the call is not queued. You must hang up and try again.

- 4 When your party answers, press the **PTT** button to talk, and release it to listen.
  - 5 When the call is completed, press the **PHON** softkey to hang up and return to normal operation.
-



## Unlimited Telephone Interconnect

### Calling a Phone Number Not in the List

- 1 Press the **▶** or **◀** button to access the **PHON** feature.

Press the softkey under the phone feature.

- 2 Enter the desired phone number from the optional keypad mic.

The display updates as the numbers are entered.

- 3 Press **Enter** on the keypad mic to make the call
  - 4 When your party answers, press the **PTT** button to talk, and release it to listen.
  - 5 When the call is completed, press the **HOME** button to hang up and return to normal operation.
-

## Storing a Number in the List

- 1 Press and hold the **PHON** softkey to select the phone programming function.
- 2 Press the **▶** or **◀** button to locate the number you want to change.
- 3 Press the **SEL** softkey to edit the number in the display.
- 4 Enter the new phone number on the keypad.

**Note:** To backspace, press the **#** button twice or the **Mode** down **▼** button once. Enter a pause by pressing the **\*** button, then the **#** button.

- 5 Press the **SEL** softkey to store the new number.
- 6 Do one of the following:
  - Press the **HOME** button to return to normal radio operation.

**OR**

- Press the **PHON** softkey to return to normal phone operation.
-

## Editing a Name in the List

- 1 Press and hold the **PHON** softkey to enter the phone ID list programming.

The **Phon** indicator flashes and a high-pitched tone sounds.

- 2 Use the navigation keys, **▶** or **◀** to locate the list member you want to change.

### OR

Use the numbered keys to go immediately to the location of a member in the list. For example, press **2** to go to the second member in the list; press **1** and **0** to go to the tenth member in the list, and so on.

- 3 Change the characters or numbers using any of the numeric keys (**0** through **9**) and special function keys (**\***, **#**).

**Note:** The maximum number of characters permitted in a text line is **14**. If you try to add too many characters, you will hear a low-pitched tone.

To edit, do any or all of the following:

- To enter a character at the blinking cursor, refer to the table on page 55.

Press the key of the desired character the number of times shown in the table. For example, to enter the character **C**, press the **2** key three times.

- To leave a space in the text, press the **Mode up ▲** rocker switch to move the blinking cursor to the next character position, and then enter the character.

- To delete characters, press the **Mode** down ▼ rocker switch to move backwards over existing characters.

When the last character on the display has been erased, press the **Mode** down ▼ rocker switch again to leave the name-edit mode, without making any changes, and begin the procedure again at step 2.

- 4** To save the changes, press and hold the **SEL** softkey.

**Note:** Press the **SEL** softkey momentarily to confirm changes to a number in the list.

- 5** Repeat steps 2 through 4 until you have modified all the desired names,

**OR**

Do one of the following:

- Press the **HOME** button to return to normal radio operation.

**OR**

- Press the **PHON** softkey to return to normal phone operation.

**Table 1: Entering Characters Using the Keypad**

Key	Number of times the key is pressed								
	1	2	3	4	5	6	7	8	9
0	0								
1	1								
2	A	B	C	2	a	b	c		
3	D	E	F	3	d	e	f		
4	G	H	I	4	g	h	i		
5	J	K	L	5	j	k	l		
6	M	N	O	6	m	n	o		
7	P	Q	R	S	7	p	q	r	s
8	T	U	V	8	t	u	v		
9	W	X	Y	Z	9	w	x	y	z
*	*	/	+	-					
#	#								

## Call Alert Page (Conventional and Trunking – Digital Modes Only)

The Call Alert feature allows a radio to selectively alert another radio, and to determine whether or not that radio received the alert. A Call Alert page can be initiated after an unsuccessful Private Conversation call or as a separate feature.

The control head is capable of responding to a Call Alert initiated by another radio. It features a unique list of up to 100 preprogrammed ID numbers. A name can be assigned to each ID in the list for your convenience.

### Sending a Call Alert Page

- 1 Press the **PAGE** softkey.

The **Page** indicator lights and a valid-key chirp sounds.

The display shows the last transmitted/received unit ID number.

- 2 Select a radio in one of the following ways:

- **From the ID number list:**

- Do nothing if you want to call the unit ID currently displayed.

**OR**

- Use the prestored list by using the navigation keys to locate the name/ID you want to call.

**OR**

- Enter, using the keypad or keypad mic, the ID of the desired unit.

**Note:** Using the keypad to enter the ID of another unit can only be accomplished from the first display shown when **Page** was entered. If the list has been entered, scroll to the first display.

- 3** Press the **SEL** softkey or the microphone **PTT** button.

The display changes to **PLEASE WAIT**.

- 4** Choose one of the following:

- When the called radio acknowledges the page, four additional tones sound and the display changes to **ACK RCVD**.

The radio returns to normal operation.

- If you are out of the range of the system, a low-pitched tone sounds.

Try again by pressing the **PTT** button or the **SEL** softkey,

**OR**

Press the **HOME** button to return to normal operation.

- If, after six seconds, the called unit fails to acknowledge the alert, a low-pitched tone sounds and the display changes to **NO ACK**.

Try again by pressing the **PTT** button or the **SEL** softkey,

**OR**

Press the **HOME** button to exit.

---

# Conventional Radio Features

---

## Features Used in Conventional Operation

This chapter shows you how to access features available in conventional operation. The following topics are covered:

- Status Calls (Digital Modes Only) (page 59)
- Smart PTT (page 62)
- Conventional Talkgroup Calls (page 62)
- Conventional Talkaround (page 64)
- Selective Calls (Digital Modes Only) (page 64)



## Status Calls (Digital Modes Only)

Radio status calls are used to inform the dispatcher of the present state of the mobile unit. For example, a status might be **ENROUTE** or **AT SITE**.

Status names are field programmable. Each radio can have up to 8 separate statuses.

### Sending a Status Call

- 1 Press the **STS** softkey, and the display shows the last-acknowledged status name.
- 2 Press the **▶** or **◀** button to review the list of status names, or use the keypad mic to enter the number of the status you wish to send.

**Note:** If no button is pressed for a period of time, an inactivity warning will sound.

- 3 The display shows the desired status name or number, press the **PTT** button to send the transmission.

One of the following conditions occurs:

- The radio display shows **PLEASE WAIT** until the transmission is received and acknowledged.

When the dispatcher acknowledges the status, four high-pitched tones sound, and the display shows **ACK RECEIVED**.

The radio then returns to normal dispatch operation.

- If the status is **not acknowledged** after approximately six seconds, the display alternates between **NO ACKNOWLEDGE** and the associated status name. A low-pitched tone also sounds continuously.

## Conventional Radio Features

---

- If there is no acknowledgment, do one of the following:

Press the microphone **PTT** button to resend the status transmission.

**OR**

Press the **HOME** button to return to normal dispatch operation.

---

## Sending a Direct-Entry Keyboard (DEK) Status

Press the desired **Sts #** button on the DEK.

The red indicator flashes while the radio is waiting for an acknowledgment. The control head momentarily displays the selected status, then shows `PLEASE WAIT`.

One of the following conditions occurs:

- When the dispatcher-acknowledge is received, four high-pitched tones sound, and the status indicator lights solid and remains on to show the last status acknowledged by the dispatch terminal.

The display also temporarily shows **ACK RCVD**.

The radio then returns to normal dispatch operation.

- If the dispatcher-acknowledge is not received, the red indicator continues to flash, the display temporarily shows **NO ACK**, and a low-pitched tone sounds. At the same time, the indicator above the last-acknowledged status lights.

The radio then returns to normal dispatch operation.

- Resend the last status.
-

## Smart PTT

Smart PTT is a per-mode feature that gives the system manager better control of radio operations. When smart PTT is enabled in your radio, you will not be able to transmit on an active mode. If you try to transmit (press the **PTT** button) on a busy or active smart PTT channel, a continuous tone sounds until you release the PTT button, and the transmission is inhibited.

The yellow **BUSY** LED lights when the radio is receiving to indicate that the mode is busy.

Three radio-wide variations of smart PTT can be enabled on your radio:

Transmit Inhibit on Busy Mode with Carrier	You will not be able to transmit if any activity is detected on the mode.
Transmit Inhibit on Busy Mode with Wrong Squelch Code	You will not be able to transmit on an active mode that has a squelch code other than your own.
Quick-Key Override	You can override either of the two previous transmit-inhibit states by quick-keying the radio (two quick PTT button presses).

## Conventional Talkgroup Calls

### Digital Modes Only

This feature allows you to define talkgroups for your conventional system. Talkgroups, combined with selective squelch operation, allow groups of users to transparently share a conventional channel. Talkgroups can be slaved to a personality through programming, or you can select them.

Encryption keys are slaved to talkgroups. When conventional talkgroups are enabled, encryption keys are changed by changing the active talkgroup.

## Selecting a Conventional Talkgroup

The *Talkgroup Select* feature allows you to manually select any one of the available talkgroups.

- 1 Press the **TGRP** softkey.  
The display changes to show the last-selected talkgroup.
- 2 Rotate the **Mode** knob to choose a different talkgroup.
- 3 Press the **SEL** softkey to save the talkgroup.

The radio returns to the home display.

**Note:** To select the default talkgroup, press the **SEL** softkey while the radio displays **PRESET**.

Selecting **PSET** softkey causes the radio to return to its preprogrammed talkgroup.

To abort the talkgroup menu, press the **HOME** button or the **PTT** button:

- Pressing **HOME** exits the talkgroup select menu without saving the selected talkgroup choice.
- Pressing the **PTT** button exits the menu without saving the selected talkgroup and allows the radio to transmit.

**Note:** If the encryption key slaved to the new talkgroup is erased, the display shows **KEY FAIL** and a momentary tone is generated. If the encryption key that is slaved to the new talkgroup is not allowed, the display shows **ILLEGAL KEY** and a momentary tone is generated.

---

## Conventional Talkaround

### Talk Direct (Mobile-To-Mobile)

To talk directly to another unit without going through the conventional repeater system:

- 1 Press the **DIR** softkey momentarily.

The **Dir** indicator lights, indicating that the radio is now transmitting directly to another unit.

- 2 To return to repeater operation, press the **DIR** softkey again.

The **Dir** indicator goes out.

**Note:** A conventional personality can be configured to always transmit on the direct mobile-to-mobile frequency. In this case, the **Dir** indicator is lit continuously while the mode is selected.

---

## Selective Calls (Digital Modes Only)

The Selective Call feature not only allows you to carry on a conversation that is heard only by the two parties involved, but also enables you to determine whether the unit you are calling is in service.

The control head is capable of responding to a Selective Call initiated by another radio. It features a unique list of preprogrammed ID numbers. A name may be assigned to each ID in the list for your convenience.

## Answering a Selective Call

When a Selective Call is received, two high-pitched tones sound and the display alternates between `CALL RECEIVED` and the home display.

- 1 Press the `CALL` softkey within 20 seconds of receiving the call. (This time is programmable by a qualified radio technician.)

The display shows the ID number of the calling unit.

- 2 To respond to the call, press the `PTT` button and talk.

If 20 seconds pass before you press the `CALL` softkey, you will not respond privately to the call just received. Instead, when you press the `CALL` softkey, you enter the *Selective Call* state, as described in “Selective Calls (Digital Modes Only)” on page 64.

If the system is busy when you attempt to answer the call, a telephone-type busy tone sounds and your radio’s **BUSY** indicator lights. When a channel becomes available, you receive a call back, and your radio automatically keys up for three seconds so that you can begin talking.

**Note:** If you do not press the `CALL` softkey before pressing the `PTT` button, your conversation will be heard by all members of the talk group.

---

## Initiating a Selective Call

To initiate a Selective Call, select a unit to call, then place the call.

- 1 Press the **CALL** softkey.

The **Call** indicator lights, and the display shows the last transmitted/received unit ID number.

- 2 Select a unit in one of the following ways:

- **From the ID number list:**

- Do nothing if you want to call the unit ID currently displayed.

**OR**

- Use the prestored list by turning the **Mode** knob to locate the name/ID you want to call.

**OR**

- Enter, using the keypad, the ID of the desired unit.

**Note:** Using the keypad to enter the ID of another unit can only be accomplished from the first display shown when **CALL** was entered. If the list has been entered, scroll to the first display.

- 3 Press the microphone **PTT** button.

A telephone-type ringing sounds if the unit you are calling is in service. The display shows **PLEASE WAIT**.



**4** Choose one of the following conditions that applies to your current call:

- If the receiving unit answers, identify yourself and begin your Selective Call.
- If, after a programmable time period, you are not connected, the display shows **NO ACKNOWLEDGE** and a momentary, low-pitched tone sounds.

Try again, or press the **HOME** button to return to normal operation.

- If you are out of the system's range, a low-pitched tone sounds.

Try again, or press the **HOME** button to return to normal operation.

- If the system is busy when you attempt to make a call, the radio you are calling hears a telephone-type busy tone. When a channel becomes available, the called radio receives a call back and automatically keys up for three seconds so that conversation can begin.

**5** To return to normal operation, press the **HOME** button.

**Note:** If you do not press the **HOME** button to hang up, your unit will remain in the Selective Call state with the other unit. You will miss all subfleet traffic and incoming phone calls.

---

## Viewing Your Unit ID Number

- 1 Press the **CALL** softkey momentarily to select the Selective Call feature.

The **Call** indicator lights.

- 2 Do one of the following:
  - Use the left navigation key to locate the **MY ID** display.

**OR**

- The display will alternate between **MY ID** and your ID number.

- 3 To return to normal operation, press the **HOME** button.
-

## Storing a Unit ID Number in the List

The Selective and Call Alert page features share the same prestored list of units' IDs.

- 1 Press and hold the **CALL** softkey to review the **Call** ID list.

The **Call** indicator flashes and a high-pitched tone sounds.

- 2 Use the navigation keys to locate the list member you want to change.
- 3 Press the **NAME** softkey to store a name

**OR**

press the **NUM** softkey to store a number.

- 4 Use the keypad mic to update the entry.
- 5 When all the digits are entered, press the **SAVE** softkey to store the new ID.
- 6 Repeat steps 2 through 5 until all the desired IDs have been entered.

**OR**

Do one of the following:

- Press the **HOME** button to return to normal radio operation.

**OR**

- Press **PTT** to exit the feature.

**Note:** The maximum number of characters permitted in a text line is **14**.

---

## Editing a Name in the List

The Selective Call and Call Alert page features share the same prestored list of unit IDs.

- 1 Press and hold the **CALL** or **PAGE** softkey to enter the **Call** ID list.

The **Call** indicator flashes and a high-pitched tone sounds.

- 2 Use the navigation keys to locate the list member you want to change.

### OR

Use the numbered keys to go immediately to the location of a member in the list. For example, press **2** to go to the second member in the list; press **1** and **0** to go to the tenth member in the list, and so on.

- 3 Press and hold the **SEL** button to select the name-editing function.
- 4 Change the characters or numbers using any of the numeric keys (**0** through **9**) and special function keys (**\***, **#**) with the keypad mic.

**Note:** The maximum number of characters permitted in a text line is **14**. If you try to add too many characters, you will hear a low-pitched tone.

To edit, do any or all of the following:

- To enter a character at the blinking cursor, refer to the table on page 55.

Press the key of the desired character the number of times shown in the table. For example, to enter the character **C**, press the **2** key three times.

- To leave a space in the text, press the up **▲** navigation key to move the blinking cursor to the next character position, and then enter the next character.

- To delete characters, press the down ▼ navigation key to move backwards over existing characters.

When the last character on the display has been erased, press the down ▼ navigation key again to leave the name-edit mode, without making any changes, and begin the procedure again at step 2.

**5** To save the changes, press and hold the **SEL** softkey.

**Note:** Press the **SEL** softkey momentarily to confirm changes to a number in the list.

**6** Repeat steps 2 through 5 until you have modified all the desired names.

**OR**

Do one of the following:

- Press the **HOME** button to return to normal radio operation.

**OR**

- Press **PTT** to exit the feature.

# Trunking Operation

---

## Features Used on Trunking Systems

This chapter shows you how to access features available on trunking systems. The following topics are covered:

- Enhanced Private Conversation (Digital Modes Only) (page 73)
- Failsoft (page 76)
- Dynamic Regrouping (Digital Modes Only) (page 77)
- SmartZone (page 80)
- Out-of-Range Indication (page 82)
- Trunked Announcement (page 83)

## Enhanced Private Conversation (Digital Modes Only)

The enhanced Private Conversation feature not only allows you to carry on a conversation that is heard only by the two parties involved, but also enables you to determine whether the unit you are calling is in service.

The control head is capable of responding to a Private Conversation call initiated by another radio. It features a unique list of preprogrammed ID numbers. A name may be assigned to each ID in the list for your convenience.

### Answering an Enhanced Private Conversation Call

When a Private Conversation Call is received, two high-pitched tones sound and the display alternates between **CALL RECEIVED** and the home display.

- 1 Press the **CALL** softkey within 20 seconds of receiving the call. (This time is programmable by a qualified radio technician.)

The display shows the ID number of the calling unit.

- 2 To respond to the call, press the **PTT** button and talk.

If 20 seconds pass before you press the **CALL** softkey, you will not respond privately to the call just received. Instead, when you press the **CALL** softkey, you enter the *Private Conversation Call* state, as described in “Initiating an Enhanced Private Conversation Call” on page 74.

If the system is busy when you attempt to answer the call, a telephone-type busy tone sounds and your radio’s **BUSY** indicator lights. When a channel becomes available, you receive a call back, and your radio automatically keys up for three seconds so that you can begin talking.

## Trunking Operation

---

**Note:** If you do not press the `CALL` softkey before pressing the PTT button, your conversation will be heard by all members of the talk group.

---



## Initiating an Enhanced Private Conversation Call

To initiate an Enhanced Private Conversation Call, select a unit to call, then place the call.

- 1 Press the **CALL** softkey.

The **Call** indicator lights, and the display shows the last transmitted/received unit ID number.

- 2 Select a unit in one of the following ways:

- **From the ID number list:**

- Do nothing if you want to call the unit ID in the display.

**OR**

- Use the prestored list by pressing the navigation keys to locate the name/ID you want to call.

**OR**

- Press the **Mode up** ▲ rocker switch once, and then use the keypad to directly advance to the desired list member.

**OR**

- Enter, using the keypad or keypad mic, the ID of the desired unit.

**Note:** Using the keypad to enter the ID of another unit can only be accomplished from the first display shown when **CALL** was entered. If the list has been entered, scroll to the first display.

- 3 Press the microphone **PTT** button.

A telephone-type ringing sounds if the unit you are calling is in service. The display shows **PLEASE WAIT**.

- 4** Choose one of the following conditions that applies to your current call:
- If the receiving unit answers, identify yourself and begin your Private Conversation.
  - If, after a programmable time period, you are not connected, the display shows **NO ACKNOWLEDGE** and a momentary, low-pitched tone sounds.

Try again, or press the **HOME** button to return to normal operation.

- If you are out of the system's range, a low-pitched tone sounds.

Try again, or press the **HOME** button to return to normal operation.

- If the system is busy when you attempt to make a call, the radio you are calling hears a telephone-type busy tone. When a channel becomes available, the called radio receives a call back and automatically keys up for three seconds so that conversation can begin.

- 5** To return to normal operation, press the **HOME** button .

**Note:** If you do not press the **HOME** button to hang up, your unit will remain in the Private Conversation state with the other unit. You will miss all subfleet traffic and incoming phone calls.

---

## Failsoft

If the trunked system's central controller fails for any reason, the radio indicates *failsoft*. In this condition, the radio transmits and receives on a pre-determined frequency in a conventional mode.

Failsoft ensures that you will have communications capability at all times. Radios can be programmed by the system administrator so units that normally communicate on the same trunked mode will be assigned to the same failsoft repeater frequency.

Since the normal trunking features do not operate during failsoft, much of the privacy of trunked systems is lost. You must share the channel with other users until the failure is corrected.

To continue, in Failsoft, to communicate with other talkgroups:

- 1 Rotate the **Mode** knob rocker switch to change to a different repeater frequency.

The failsoft condition is indicated by a faint beeping tone every every nine seconds (radio unscelched).

When the trunking system returns to normal operation, the beeping tone stops.

- 2 Press the **PTT** button to talk, and release the button to listen.
- 

Failsoft:

If a system that is in failsoft is accessed while in scan, the radio freezes scan and remains on the failsoft frequency for a period of six seconds. This time period can be changed by a qualified radio technician. This allows the operator to monitor the failsoft frequency for activity before resuming scanning.

## Dynamic Regrouping (Digital Modes Only)

The dynamic regrouping feature allows the dispatcher to temporarily reassign selected individuals, operating in separate trunked talkgroups, into a single group so that they can communicate.

### Receiving a Dynamic Regrouping ID Assignment

When your unit receives a dynamic regrouping ID assignment, a unique chirp sounds to alert you that your unit has been dynamically regrouped. The display shows the new dynamic mode name assignment. Examples of the field-programmable dynamic mode names include 16 DYNMC, 8 TACTCL.

- Press the **PTT** button. The radio makes a chirp and transmits on the dynamically assigned mode.

After the dispatcher releases your mobile from the dynamic ID assignment, your radio returns to the last selected, non-dynamic regrouping mode.

- If no dynamic regrouping assignment has been made, a low-pitched tone sounds if you attempt to select a dynamic mode.
-

## Selecting Enable and Disable (Digital Modes Only)

The dispatcher may classify regrouped units into one of two categories: *select-enabled* or *select-disabled*.

**Select-enabled** Units are free to make mode changes to any of the available talkgroups, including the dynamic group.

**Select-disabled** Units cannot change modes because the dispatcher has specifically chosen to force the unit to remain in the dynamic mode.

## Requesting a Dynamic Regrouping (Digital Modes Only)

Pres the **RPGM** softkey to request regrouping.

A high-pitched tone sounds, indicating your request was received by the system's central controller.

The display changes to **REPROGRAM RQST** while the request is being processed.

If the regrouping request is **acknowledged**, a dispatcher-acknowledge signal sounds (four high-pitched tones), and the display shows **ACK RECEIVED**.

The radio then returns to normal operation.

If the regrouping request is **not acknowledged** within six to eight seconds, the display alternates between showing **NO ACKNOWLEDGE** and a low-pitched tone sounds.

At this time, do the following:

- Press the **PTT** button to resend the regroup request

**OR**

- Press the **HOME** button to return to normal operation.

## SmartZone

The SmartZone® feature extends communications beyond the reach of a single-trunked site (antenna location) when operating in a SmartZone system. SmartZone units provide expanded wide-area coverage.

SmartZone automatically switches the radio to a different site when the current site signal becomes unacceptable. This usually happens when the vehicle in which the radio is located is driven out of the range of one site, and into the range of another.

Under normal conditions, a SmartZone-enabled radio functions invisibly to the operator. However, the operator does have some manual controls on the Control Head: the `SITE` softkey. This button can be used to check, or change, the SmartZone operation.

## Site-Button Operation

To check which site the radio has currently selected:

Press the `SITE` softkey momentarily.

The display momentarily shows the current site name and RSSI (received signal strength indicator).

One of the following conditions can also occur:

- If the radio is not locked onto a site, but is scanning for a new site, the display shows `SCANNING`.
- If the radio has not yet received site ID information for the current site, the radio displays `SITE XX`.

## Locking onto a Site

In areas that commonly have weak signals, use the SmartZone lock function to prevent the radio from automatically scanning for a new site.

- 1 Press the `SITE` softkey momentarily to display the current lock status.

Either the display shows `SITE LOCKED` or `SITE UNLOCKED`. Press **HOME** button or `SITE` softkey again to return to normal operation.

- 2 To change the locked or unlocked condition, press and hold the `SITE` softkey until a tone sounds and the display changes.

After temporarily displaying the new condition, the radio returns to normal operation.

---

## Site Trunking

In a SmartZone system, if the zone controller for a particular site fails, the site enters into a site-trunking operational mode. In this mode of operation, the user can only communicate with other units at the same site.

Radios in a SmartZone system can be programmed by a qualified radio technician to display `SITE TRUNKING` when site trunking becomes active. The display alternates with the current mode display as long as the radio remains in site trunking. The radio also sounds a valid-key chirp when it first detects site trunking.

## Out-of-Range Indication

The out-of-range display/audible indication feature can be enabled by a qualified radio technician. The display alternately shows **OUT OF RANGE** and the current selected mode, and a low-pitched tone sounds every six seconds:

- When the radio is out of range of the system and can no longer lock onto the control channel

### **OR**

- When the radio is in failsoft and cannot lock onto the failsoft channel.

The out-of-range indication remains in effect until one of the following conditions occur:

- The radio locks on a control channel
- The radio locks on a failsoft channel
- The radio is turned off



## Trunked Announcement

The announcement capability allows a user to make announcements to the entire user group, as well as monitor talkgroup calls and other announcements.

Announcement calls are handled in two different ways, depending on the trunked central controller configuration. The two types are called *ruthless* and *non-ruthless* preemption.

- **Ruthless Preemption:** When a ruthless preemption announcement call is initiated, the requesting radio begins transmitting immediately. All associated talkgroup calls taking place on other channels are immediately halted, and the radios are steered to the announcement call.

Transmitting radios continue to transmit until the PTT button is released, at which time they also unmute for the announcement call. Individual calls (Private Conversation and telephone interconnect) are not affected.

- **Non-Ruthless Preemption:** When a non-ruthless preemption announcement is initiated, the initiating unit receives a telephone-type busy tone, followed by a call back when all associated talkgroup conversations end.

Once an announcement call is pending, any attempts by other users to initiate a talkgroup call will result in a telephone-type busy tone. These users will not receive a call back until the announcement call is complete.

## Initiating an Announcement

If your radio has been programmed to allow announcement calls:

- 1 Rotate the **Mode** knob to locate the announcement-group mode.
  - 2 Press the microphone **PTT** button to initiate the announcement.
-

# ARS User Login and Text Messaging Features

---

## Automatic Registration Service (ARS)

The Automatic Registration Service feature provides an automated data application registration for the radio. When you turn on the radio, the device automatically registers with the server. Data applications within the fixed network can determine the presence of a device on the system and send data to the device. For example, Text Messaging Service (TMS).

The Automatic Registration Service for the radio consists of 2 modes:

- ARS Server Mode (default mode)
- ARS Non Server Mode

**Note:** The default ARS mode can be changed by a qualified radio technician using the radio's programming software.

## Selecting or Changing ARS Mode

To change an ARS mode in the current zone, do the following:

After the zone you want is displayed, rotate the **Mode** knob until the display shows the desired mode name.

**OR**

Press and hold the ► button to find CHAN.



Press the ◻ button directly below CHAN.

The display shows the current channel/mode name (in this case, ARSNSUR) blinking and the zone (Z1), not blinking.



Press the ► button to find the channel /mode you want.

**OR**

Rotate the **Mode** knob.

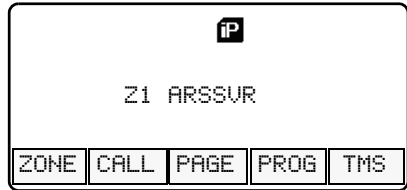

Server mode

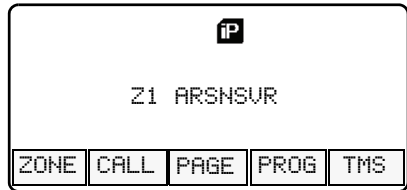

ARS non-server mode

Press the  button to confirm the displayed zone and mode/channel.

---

## ARS User Login Feature

The user login feature allows you as the user to be associated with the radio. With this association, every data application such as Text Messaging Service, will take on a friendly username. You can still send text messages without logging in as a user. The user login feature only enables the recipient of your message to identify you as the sender by assigning a username to your message.

### Accessing the User Login Feature

The user login feature can be accessed by selecting a menu item on the display or through a programmable button.

- 1 Press the ► button until `USER` appears on the display.
- 2 To access the user login screen through the menu item, press the  button below `USER`.

To access the user login screen through a preprogrammed button, press the preprogrammed user button on the keypad microphone.

**Note:** See “Programmable Buttons” on page 9 for information on preprogrammed buttons.

- 3 The user login screen appears.

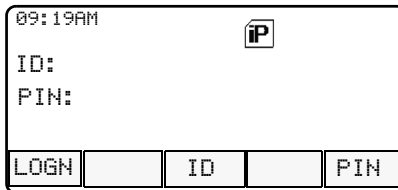

## To Login as a User

- 1 Press the  button below ID to enter your username at the prompt.

**Note:** Username will not be case sensitive in server mode and will be case sensitive in non-server mode.



- 2 You need to use the keypad microphone to manually enter a username. You can enter a username via direct entry using the keypad multi-tap function. Press the button labeled with the desired character, once for the first character, twice for the second, and so on.

For example:

To enter "S", press the  button four times. To enter "7", press the button five times. If you do not press a button for a few seconds, the character is accepted, and the cursor moves to the next position.

Press the  button to delete a character.

Key	Number of times the button is pressed								
	1	2	3	4	5	6	7	8	9
0	0								
1	1	-	*	#	/				
2 abc	A	B	C	2	a	b	c		
3 def	D	E	F	3	d	e	f		
4 ghi	G	H	I	4	g	h	i		
5 jkl	J	K	L	5	j	k	l		
6 mno	M	N	O	6	m	n	o		
7 pqrs	P	Q	R	S	7	p	q	r	s
8 tuv	T	U	V	8	t	u	v		
9 wx yz	W	X	Y	Z	9	w	x	y	z
*	Space								
#	Delete a character								

**OR**

Select a predefined username from the list of predefined username. See “Selecting a Predefined Username” on page 92 for information on how to add a predefined username.

**Note:** Valid characters for username entry are capital letters A-Z, small letters a-z, numbers 0-9, ‘\*’, ‘#’, ‘-’, ‘/’ and the space character. The maximum username length is 8 characters.

- 3 Press the  button below PIN to enter your PIN (Personal Identification Number) number at the prompt. You need to use the keypad microphone to manually enter a PIN number. The maximum PIN length is four digits. The PIN number will appear as asterisks.



- 4 To log in :

Press the  button below LOGN.

In ARS server mode:

The progress screen appears.



Server mode

In ARS non-server mode:

The “logged in” confirmation screen appears.



Non-ARS enabled mode

In non-ARS enabled mode:

The display shows OFFLINE.

- 5 Press the  button below CNCL to cancel the login in progress screen and return to the initial user login screen.

- 6 The logged in confirmation screen appears when the login process is successful. The “successful user login” indicator (IP indicator) will be shown on the display.



- 7 When you enter an invalid username or PIN, login fails and the user login screen will display a momentary text LOGIN FAILED. The user login failure indicator (blinking IP indicator) is shown on the display.







**8** To log out :

Press the  button below LOGT

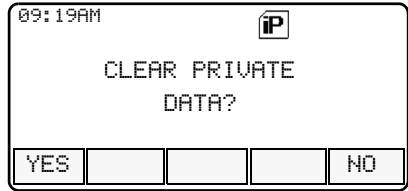
Upon pressing the LOGT button, a confirmation screen appears.



Press the  button below YES to clear all your private data. A momentary text PRIVATE DATA CLEARED is shown.

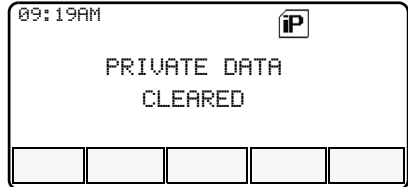

**OR**

Press the  button below NO to keep your private data.

**Note:** Private data refers to all messages in the text messaging Inbox, Draft and Sent folder. The next radio user will be able to access your Inbox, Draft and Sent messages if private data is not deleted.

## Selecting a Predefined Username

- 1 Press the ► button to scroll to the next username.

Press the ◀ button to scroll to the previous username.

Press and hold the ► button to scroll to the next usernames continuously one at a time at a fast scroll rate.

Press and hold the ◀ button to scroll to the previous usernames continuously one at a time at a fast scroll rate.

### OR

Rotate the **Mode** knob to scroll through the usernames.

- 2 If you log in with a selected predefined username comprising of 8 characters or more, or one with an invalid character, you will see a momentary text `INVALID ID` on the display.

**Note:** A predefined username may sometimes be invalid because the programming software that is used to set predefined usernames allows you to set usernames comprising of 8 characters or more.

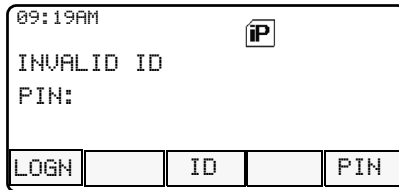

## Text Messaging

The Text Messaging Service (TMS) is an application service through which you can send and receive text messages. You can send 3 types of text messages, namely

- A new text message (free form messages)
- Predefined messages (quick text messages)
- Edited quick text messages

## Accessing TMS Feature

### *Use the Menu*

- 1 Press the ► button until TMS appears on the display.
- 2 Press the  button directly below TMS.

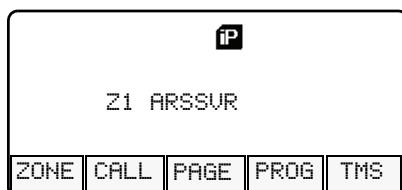

---

### *Use the TMS Feature Button*

Press  button on the keypad microphone to access the TMS feature screen.

---

**Use the Preprogrammed TMS Button**

Press the preprogrammed button on the keypad microphone to access the TMS feature screen.

Pressing and holding the preprogrammed TMS button brings you directly to the Inbox screen.

**Note:** Any programmable button on the keypad microphone can be programmed to access TMS feature. See “Programmable Buttons” on page 9.

---

The TMS feature’s main menu consists of the Inbox, Compose, Draft, Sent and Back option.

See “TMS Menu Options” on page 95 for explanation on each menu option.

Press the ◀ or ▶ button to scroll through the main menu options.

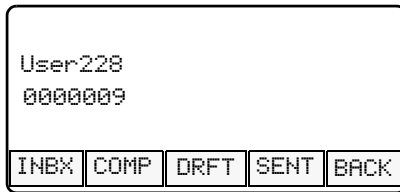











**Table 2: TMS Menu Options**

<b><i>Menu Options</i></b>	<b><i>Description/ Function</i></b>
INBX	This is used to store new incoming messages or messages that you have received. The Inbox can hold up to 30 messages.
COMP	This menu option brings you to the compose screen.
DRFT	This is used to store all saved messages or messages that are to be sent at a later time. The Draft folder can hold up to 10 messages.
SENT	This is used to store the messages that you have already sent. The Sent folder can hold up to 10 messages.
BACK	This menu option brings you back to the TMS main menu or previous menu.
EDIT	This menu option brings you to the Quick Text Messages screen.
SAVE	This menu option allows you to save your messages to the Draft folder.
RPLY	This menu option allows you to reply to a message.
DEL	This menu option allows you to delete a message.
ADDR	This menu option allows you to key in the target address, or select one from the list.
NEW	This menu option allows you to compose a new message.
LIST	This menu option allows you to select a predefined message.
IMPT	This menu option is used to toggle on/off the "Priority" flag for an outgoing message.

<b>Menu Options</b>	<b>Description/ Function</b>
RGRP	This menu option is used to toggle on/off the “Request Reply” flag for an outgoing message.
CURR	This menu option is used to delete the current selected message.
ALL	This menu option is used to delete all the messages in the current message folder.

**Table 3: TMS Status Symbols**

<b>Symbol</b>	<b>Indication</b>
	<p><b>Priority Message</b> This icon is displayed</p> <ul style="list-style-type: none"> <li>• when incoming message is a “Priority” message.</li> <li>• when “Priority” is toggled on before sending the message.</li> <li>• in the Inbox folder for messages which are flagged with “Priority”.</li> </ul>
	<p><b>Request Reply</b> This icon is displayed</p> <ul style="list-style-type: none"> <li>• when “Request Reply” is toggled on before sending the message.</li> <li>• in the Inbox folder for messages which are flagged with “Request Reply”.</li> </ul>
	<p><b>Inbox Full</b> This icon is displayed when the Inbox folder is full.</p>

<b>Symbol</b>	<b>Indication</b>
	<b>New Message Icon</b> This icon is displayed when a new incoming message is received.
	<b>Message Sent</b> This icon indicates that the selected message has been successfully sent.
	<b>Message Unsent</b> This icon indicates that the selected message was not successfully sent.
	<b>Read Message</b> This icon is used to indicate that the selected message in the Inbox has been read.
	<b>Unread Message</b> This icon indicates that the selected message in the Inbox folder has not been read.
<b>Inbox 3/6</b>	<b>Message Index</b> This icon indicates the index of the current message the user is viewing. Example: If the user is looking at the third message out of a total of six messages in the Inbox folder, the icon is displayed as the icon on the left column.
	<b>Num Lock</b> This icon indicates that the text entry is currently in num lock mode.
	<b>Normal Mode</b> This icon indicates that the text entry is currently in the normal mode.

Symbol	Indication
	<p><b>Uppercase</b> This icon is displayed during text editing mode to indicate that the text entry is currently in uppercase mode.</p>

## Receive a Message

When you receive a momentary text, NEW MSG appears on the display along with a new message icon.



## To View Message from the Inbox.

- 1 Access TMS (or Launch TMS).

Press the  button directly below INBX.

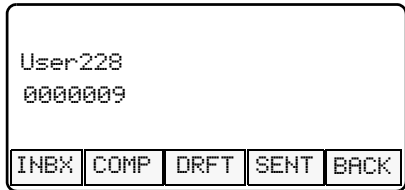

- 2 The Inbox screen appears. The first message in the list is displayed. Message status icons are displayed at the top of the screen. See “TMS Status Symbols” on page 96 for further details on these icons.



**Note:** If the message fills more than one screen, scroll to read it by pressing the ▲ or ▼ button.



- 3 Press the ► or ◀ button to scroll through the messages.

**OR**

Rotate the **Mode** knob.

- 4 To delete the message, press the  button below DEL. See “Delete a Message” on page 106 for further details.
- 

## Compose a New Text Message

- 1 Press the  button below COMP to compose a new message.

The Compose Message Screen appears.

LIST or NEW option appears on the display.



- 2 Press the  button below NEW to type a new message.

A blinking cursor appears on the display indicating point of input.



### 3 Writing Text



Type your message using the keypad microphone.  
 Press the button labeled with the desired character, once for the first character, twice for the second, and so on.

For example:

To enter “s”, press the (7pqrs) button four times. To enter “7”, press the button five times. If you do not press a button for a few seconds, the character is accepted, and the cursor moves to the next position.

Press (#) button to delete a character.

Key	Number of times the button is pressed (in normal mode)								
	1	2	3	4	5	6	7	8	9
(0)	0 or press and hold to toggle between normal text entry mode, uppercase mode and num lock mode.								
(1)	1 . , ? ! ; @ _ - * # & \$ / + = \ “ ‘ ( )								
(2 abc)	a	b	c	2	A	B	C		
(3 def)	d	e	f	3	D	E	F		
(4 ghi)	g	h	i	4	G	H	I		
(5 jkl)	j	k	l	5	J	K	L		
(6 mno)	m	n	o	6	M	N	O		
(7 pqrs)	p	q	r	s	7	P	Q	R	S
(8 tuv)	t	u	v	8	T	U	V		
(9 wxyz)	w	x	y	z	9	W	X	Y	Z
(*)	Space								
(#)	Delete a character								

You can move the cursor by pressing the  or  button on the keypad microphone.

Press and hold 0 to toggle between normal text entry mode, uppercase mode and num lock mode.

- Note:**
- i) During the uppercase mode, multi-tapping the buttons will only scroll through the uppercase letters.  
(Example : A->B->C->2)
  - ii) During the num lock mode, pressing the keypad will only enter the numeric digits. Subsequent presses of the same button will insert the same digit to the text message (no multi-tap).

#### 4 Addressing a message

Press the  button below ADDR to address your outgoing message.

The Address input screen appears.



Press the ◀ or ▶ button to scroll through the address list.

**OR**

Use direct address entry via multi-tap.

**Note:** The address will not be case sensitive in server mode and case sensitive in non-server mode.

#### 5 Append a Priority Flag or Request Reply

Before sending your message, you can set a priority flag or a request reply to your message.

Press the  button below IMPT to toggle on/off a “Priority” flag for an outgoing message. A “Priority” flag is displayed at the top of the screen when it is toggled on. See “TMS Status Symbols” on page 96.

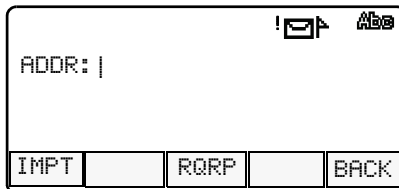

**Note:** When you receive a message on the XTL 2500 mobile radio that is flagged with the “Request Reply” icon, you must manually respond to the sender that you have received the message. The system will not automatically send back a notification that the radio received such message.

**Note:** The “Priority” flag on a message does not imply that the message will get higher priority over the other messages when it is being transmitted. It is just an indication that can be embedded into a message to let the receiver know that the message is important.

Press the  button below **RORP** to toggle on/off a “Request Reply” icon for an outgoing message. A “Request Reply” status icon is also displayed at the top of the screen when it is toggled on. See “TMS Status Symbols” on page 96.

- 6 When an address has been appended to the outgoing message, press the **PTT** button to send your message.

**OR**

Press the  button below **SAVE** to save your message for sending at a later time.

The message will be saved in the Draft folder. See “To Access the Draft Folder” on page 107 for further details.

---

## Send a Predefined Message

The Quick Text Messages are messages that are predefined and usually consist of messages that are used most frequently.

- 1 Press the  button below **LIST** to use the predefined message.

**OR**

Press the preprogrammed Quick Text button.

**Note:** Any programmable button on the keypad microphone can be programmed to access the Quick Text Messages feature. See “Programmable Buttons” on page 9.

The first predefined message appears.



Press the ▶ or ◀ button to scroll through the messages.

**OR**

Rotate the **Mode** knob.

- 2 When a message has been selected from the list, press the **PTT** button to send the message.
- 

## Edit a Quick Text Message

- 1 Press the  button below **EDIT** to edit a quick text message.

The Editing Screen appears. A blinking cursor appears at the end of the predefined text.

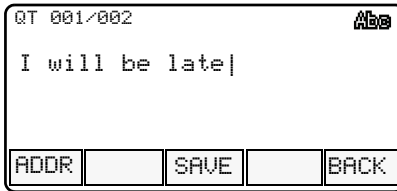

- 2 Edit your message using the keypad.
  - 3 Press the  button below **SAVE** to save the edited changes. The message is saved in the Draft folder.
  - 4 Press the **PTT** button to send the edited message.
-

## Reply to a Received Message

- 1 Press the  button below RPLY to reply to a message.

The Compose Message Screen appears.

LIST or NEW option appears on the display.



- 2 Press the  button below NEW to type a new message.

**OR**

Press the  button below LIST to use the predefined message / quick text message. See "Send a Predefined Message" on page 103 for further details.

---

## Delete a Message

- 1 From the Inbox, Draft or Sent screen, scroll to select a message for deletion.

- 2 After selecting a message, press the  button below DEL. The display shows 2 delete options.

Press the  button below CURR to delete only the current message.



### OR

Press the  button below ALL to delete all messages.

- 3 When you select to delete all messages, a confirmation screen appears.

Press the  button below YES to delete all messages.

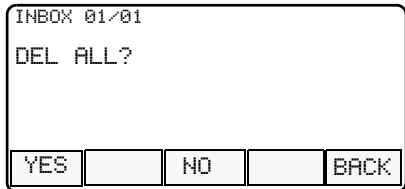



## To Access the Draft Folder

The Draft folder stores the messages that were saved previously. The Draft folder can hold up to 10 messages. The oldest message in the folder will be deleted when the 11th message comes in.

- 1 Press the  button below DRFT. The Draft screen appears.

The first draft in the list is displayed.



- 2 Press the ► or ◀ button to scroll through the list of drafts.

**OR**

Rotate the **Mode** knob.

---

## To Access the Sent Folder

The Sent folder stores the messages that were sent out previously. The Sent folder can hold up to 10 messages. The oldest Sent message in the folder will be deleted when the 11th message comes in.

- 1 Press the  button below SENT. The Sent screen appears.

The first sent message in the list is displayed. A message delivery icon will be displayed at the top right corner of the screen. See “TMS Status Symbols” on page 96 for details on Message success delivery icon and Message delivery failure icon.



- 2 Press the **▶** or **◀** button to scroll through the list of messages that have been sent.

**OR**

Rotate the **Mode** knob.

---

# Secure Operation

---

## Features Available on Secure XTL 2500

This chapter covers features available on XTL 2500 Digital Mobile Radios with secure encryption. The following topics are covered:

- Receiving a Private Message (page 110)
- Transmitting a Private Message (page 110)
- System Considerations (page 111)
- Loss Indication (page 111)
- Selecting an Encryption Key (Conventional Only) (page 112)
- Selecting an Encryption Index (Conventional Only) (page 114)

**Note:** Keyloading is not available from the control head in a remote mount configuration; however, it is available from the front of the transceiver.

Digital and Secure modes does not apply to 900 MHz band radios.

## Receiving a Private Message

- 1 Select a mode by rotating the **Mode** knob.
- 2 Using the **Volume** Knob, adjust the volume to a comfortable listening level.

In conventional modes and, if enabled, in trunking modes, the **BUSY** light blinks and the radio unmutes when the radio is receiving a private message.

**Note:** The secure on/off state does not affect received messages. The radio automatically receives coded or clear messages.



---

## Transmitting a Private Message

- 1 Press the **SEC** softkey to turn on the coded mode.

Some radio modes may have secure automatically set on or off if the *mode-strapped Secure* feature is enabled.

The display shows the current key if *multi-key* has been enabled.

**Note:** If the coded mode is selected, the  is on. If the standard (clear) mode is selected, the  indicator is off.

- 2 Monitor the mode to be sure it is not in use.
- 3 Press and hold the **SEC** softkey to transmit.

The **XMIT** indicator lights, and the display shows the current key selected when transmitting in the coded mode, if *multikey* and *Display on PTT* are enabled.

---

## System Considerations

- **Trunked Systems only:** If you press the **PTT** button when no secure-voice channel is available, the display shows `NO SECURE`, and a continuous talk-prohibit tone sounds until you release the **PTT** button.
- **Analog trunking systems:** You **are not allowed** to change from a secure transmission to a clear transmission during a secure trunked call. If you attempt to change from a secure to a clear transmission during a call, the radio generates a talk-prohibit tone, and the display will show `SEC ONLY` or `SECURE ONLY`.
- **Digital trunking systems:** You **are allowed** to change from a secure transmission to a clear transmission during a secure trunked call.

## Loss Indication

When you press the PTT button while in the coded mode and without the encryption module containing a valid key, the speaker generates bursts of alert tones, and the display shows `KEY FAIL` until you release the PTT button.

When the radio is first turned on, six medium-pitched tones sound and the display momentarily shows `KEY FAIL` to indicate that the encryption module does not contain a valid key for the current mode.

If the periodic keyfail tone feature is enabled, six medium-pitched tones are generated every five to ten seconds while the radio is not transmitting or receiving to remind you that the radio does not have a valid key for the current mode. The keyfail reminder will not sound when the radio is in clear mode.

## Selecting an Encryption Key (Conventional Only)

The Select Key feature allows you to manually select any one of the 16 encryption keys.

If the current mode is programmed with key selection being strapped to force the current mode to use a predetermined key, the Select Key menu will not appear as a Secure menu item.

- 1 Press and hold down the `SEC` softkey until a tone sounds, which indicates entry into the Advanced Secure menu.
- 2 Use the navigation keys to locate the `KEY SEL` option.
- 3 Press the `SEL` softkey to enter the Key Selection menu.

The display changes to show the last user-selected key.

- 4 Do one of the following:
  - Use the navigation keys to review the encryption keys,

**OR**

- Use direct keypad entry to access the encryption keys.

- 5 Choose one of the following:
  - To save a key, press the `SEL` softkey.

The radio returns to the home display.

- To select the default encryption keys on a radio-wide basis, press the `SEL` softkey while the radio displays `PRESET`.

Selecting preset causes the radio to return to its preprogrammed keys on a per-zone/-mode basis.

**Note:** When you scroll to an erased key, the display alternates between the key name and `ERASED`.

- 6** To abort this menu, press the **HOME** button or the **PTT** button.

Pressing **HOME** exits the key-select menu without saving the selected key choice.

Pressing the **PTT** button exits the menu without saving the selected key choice and allows the radio to transmit.

When you abort the key-select menu, the radio uses the key that was selected prior to entry into the menu.

---

## Selecting an Encryption Index (Conventional Only)

The *Select an Index* feature allows you to select one or more groups of several encryption keys from among the available keys stored in the radio. For example, you could have a group of three keys structured to one index, and another group of three different keys structured to another index. By changing indices, you would automatically switch from one set of keys to the other.

If the mobile does not support indexing, the index menu will not appear as a Secure menu item.

- 1 Press and hold down the **SEC** softkey until a tone sounds, which indicates entry into the Advanced Secure menu.
- 2 Use the navigation keys to locate the **INDX SEL** option.
- 3 Press the **SEL** softkey to enter the Index Selection menu.

The display changes to show the last index that was selected and stored after the Index Selection menu was entered.

- 4 Use the navigation keys to locate the desired key index.
  - 5 Choose one of the following:
    - To save an index key, press the **SEL** softkey. The radio will save the index and return to normal operation,
    - To abort from the Index Selection menu, press the **HOME** button or the **PTT** button. (Pressing the **PTT** button allows the radio to transmit.)
-



## Troubleshooting

The following are suggestions to assist you in troubleshooting possible operating problems.



### CAUTION

The cables that connect to the rear of the radio could have live voltage on some of their pins. Do not remove or reconnect these cables. Only a qualified radio technician should perform this task. Service performed by unauthorized personnel may cause the radio to transmit an emergency alarm even if the unit is turned off.

If your radio is locked up or the display shows **FAIL 01/90**, turn the radio off and then back on. If this does not correct the condition, take the radio to a qualified radio technician for service.

If radio operation is intermittent, check with other persons using the system for similar problems before taking the radio in for service. Similar problems indicate a system malfunction rather than a radio failure.

If symptoms persist or, if your unit exhibits other problems, contact a qualified radio technician.

# Accessories

---

Motorola provides the following approved accessories to improve the productivity of your XTL 2500 mobile two-way radio.

For a list of Motorola-approved antennas, batteries, and other accessories, visit the following web site:

<http://www.motorola.com/cgiss/index.shtml>

## Antennas

Part No.	Description
HAD4006_	VHF, 136 – 144 MHz, quarterwave whip, roof mount
HAD4007_	VHF, 144 – 150.8 MHz, quarterwave, roof mount
HAD4008_	VHF, 150.8 – 162 MHz, quarterwave, roof mount
HAD4009_	VHF, 162 – 174 MHz, quarterwave, roof mount
HAD4014_R	VHF, 140 – 174 MHz, halfwave, roof mount
HAD4016_	VHF, 136 – 162 MHz, quarterwave, wideband, roof mount
HAD4017_	VHF, 146 – 174 MHz, quarterwave, wideband, roof mount
RAD4000_	VHF, 136 – 174 MHz, halfwave, roof mount
RAD4002_RB	VHF, 136 – 144 MHz, quarterwave
RAD4003_RB	VHF, 144 – 150.8 MHz, quarterwave
RAD4004_RB	VHF, 150.8 – 162 MHz, quarterwave
RAD4005_RB	VHF, 162 – 174 MHz, quarterwave
RAD4010_RB	VHF, 136 – 174 MHz, halfwave, roof mount

HAE4003_	UHF, 450 – 470 MHz, quarterwave whip
HAE4004_	UHF, 470 – 512 MHz, quarterwave
HAE4011_	UHF, 450 – 470 MHz, 3.5 db, roof mount
HAE4012_	UHF, 470 – 495 MHz, 3.0 db, roof mount
HAE4013_	UHF, 494 – 512 MHz, 3.0 db, roof mount
HAE6010_	UHF, 380 – 433 MHz, 3.5 db gain
HAE6011_	UHF, 380 – 433 MHz, 5.0 db gain
HAE6012_	UHF, 380 – 433 MHz, quarterwave whip
HAE6013_	UHF, 380 – 470 MHz, 2.0 db gain, wideband
HAE6015_	UHF, 450 – 512 MHz, broadband
HAE6016_	UHF, 490 – 512 MHz, quarterwave whip, motorcycle
RAE4014_RB	UHF, 450 – 470 MHz, 5.0 db
RAE4015_RL	UHF, 470 – 494 MHz, 5.0 db gain
RAE4016_RB	UHF, 494 – 512 MHz, 5.0 db gain
RAE4024_RB	UHF, 450 – 482 MHz, quarterwave whip, motorcycle
HAF4002	800 – 870 MHz, quarterwave, roof mount
HAF4013_	764 – 870 MHz, quarterwave, roof mount
HAF4014_	764 – 870 MHz, quarterwave, roof mount

HAF4016_	764 – 870 MHz, quarterwave, roof mount
RRA4935_	900 MHz (890 – 960 MHz) 3dBi Low Roof Top 14' cable length
RAF4003_RM	900 MHz (890 – 960 MHz) 3 dBi Low Roof Top 22' cable length

## Bull Horns for Siren and Public Address

Part No.	Description
TDN6251_	Round with chrome finish
TDN6252_	Rectangular with chrome finish
TDN6253_	Underhood with gray finish
TDN6254_	Round with gray finish

## Cables

Part No.	Description
HKN4191_	Power, high-power, dash-mount
HKN4192_	Power, 20-ft., remote-mount
HKN4356_	17-ft. (W4/5/7/9)
HKN6160_	Data, 6-ft., dash-mount (kit)
HKN6161_	Data, 20-ft., dash-mount (kit)
HKN6163_	USB
HLN4952_	Fuse kit for green/orange leads
HKN6164A	Remote Mount Cable (CAN) - 40M (131 FT)
HKN6165A	Remote Mount Cable (CAN) - 35M (115 FT)

HKN6166A	Remote Mount Cable (CAN) - 23M (75 FT)
HKN6167A	Remote Mount Cable (CAN) - 15M (50 FT)
HKN6168A	Remote Mount Cable (CAN) - 10M (30 FT)
HKN6169A	Remote Mount Cable (CAN) - 5M (17 FT)
HKN6170A	Remote Mount Cable (CAN) - 3M (10 FT)
HKN6182A	Cable/Adapter, Keyloader
HKN6184A	Cable, CH Programming (RS-USB)
HKN6183A	Cable, CH Programming (RS-232)
HKN6184	Flash/Programming cable (USB)
HKN6183	Flash/Programming cable (RS232)
YLN1148_	Armored, for handset/hangup mic
HMN4082A	Armored, for handset/hangup mic

## Microphones

Part No.	Description
HMN1079_	Motorcycle Palm D-Sub 9 connector
HMN4081A	Motorcycle Palm GCAI connector
HMN4079_	Keypad Mic
HMN6185A_	Standard palm
RLN6080A_	GCAI Handset Model III

## Miscellaneous

Part No.	Description
HLN5113_	Emergency footswitch
HLN6188_	Emergency pushbutton
HLN6372_	Key lock mount

## Remote Mounting Kits

Part No.	Description
HLN6921A	Remote-to-dash
HLN6922A	Dash-to-remote

## Speakers

Part No.	Description
HSN4031_	7.5 W external
HSN4032_	13 W external
HSN4038_	7.5 W remote weather-resistant
HSN4039_	13 W remote weather-resistant
HSN6003_	Motorcycle, weather-resistant

## Trunnion Kits

Part No.	Description
HLN6909_	Quick-release, high-power
HLN6910_	Standard high-power
HKN6186A	Trunnion, CH Remote Mount
HLN6861	HDWR Millenium St. Install - Mid Power

# Appendix: Maritime Radio Use in the VHF Frequency Range

---

## Special Channel Assignments

### Emergency Channel

If you are in imminent and grave danger at sea and require emergency assistance, use **VHF Channel 16** to send a distress call to nearby vessels and the United States Coast Guard. Transmit the following information, in this order:

**1** “MAYDAY, MAYDAY, MAYDAY.”

**2** “THIS IS \_\_\_\_\_, CALL SIGN \_\_\_\_\_.”

*State the name of the vessel in distress **3 times**, followed by the call sign or other identification of the vessel, stated **3 times**.*

**3** Repeat “MAYDAY” and the name of the vessel.

**4** “WE ARE LOCATED AT \_\_\_\_\_.”

*State the position of the vessel in distress, using any information that will help responders to locate you, e.g.:*

- *latitude and longitude*
- *bearing (state whether you are using true or magnetic north)*
- *distance to a well-known landmark*
- *vessel course, speed or destination*

**5** State the nature of the distress.

**6** Specify what kind of assistance you need.

**7** State the number of persons on board and the number needing medical attention, if any.

**8** Mention any other information that would be helpful to responders, such as type of vessel, vessel length and/or tonnage, hull color, etc.

**9** “OVER.”

**10** Wait for a response.

**11** If you do not receive an immediate response, remain by the radio and repeat the transmission at intervals until you receive a response. Be prepared to follow any instructions given to you.

### Non-Commercial Call Channel

For non-commercial transmissions, such as fishing reports, rendezvous arrangements, repair scheduling, or berthing information, use **VHF Channel 9**.

### Operating Frequency Requirements

A radio designated for shipboard use must comply with Federal Communications Commission Rule Part 80 as follows:

- on ships subject to Part II of Title III of the Communications Act, the radio must be capable of operating on the 156.800 MHz frequency
- on ships subject to the Safety Convention, the radio must be capable of operating:
  - in the simplex mode on the ship station transmitting frequencies specified in the 156.025–157.425 MHz frequency band, and
  - in the semiduplex mode on the two frequency channels specified in the table below.

**Note:** Simplex channels 3, 21, 23, 61, 64, 81, 82, and 83 **cannot be lawfully used** by the general public in US waters.

Additional information about operating requirements in the Maritime Services can be obtained from the full text of FCC Rule Part 80 and from the US Coast Guard.

**Table A-1: VHF Marine Channel List**

Channel Number	Frequency (MHz)	
	Transmit	Receive
1	156.050	160.650
2	156.100	160.700
*	156.150	160.750
4	156.200	160.800
5	156.250	160.850
6	156.300	–
7	156.350	160.950



**Table A-1: VHF Marine Channel List (Continued)**

Channel Number	Frequency (MHz)	
	Transmit	Receive
8	156.400	–
9	156.450	156.450
10	156.500	156.500
11	156.550	156.550
12	156.600	156.600
13**	156.650	156.650
14	156.700	156.700
15**	156.750	156.750
16	156.800	156.800
17**	156.850	156.850
18	156.900	161.500
19	156.950	161.550
20	157.000	161.600
*	157.050	161.650
22	157.100	161.700
*	157.150	161.750
24	157.200	161.800
25	157.250	161.850
26	157.300	161.900
27	157.350	161.950
28	157.400	162.000
60	156.025	160.625
*	156.075	160.675
62	156.125	160.725
63	156.175	160.775
*	156.225	160.825
65	156.275	160.875
66	156.325	160.925

**Table A-1: VHF Marine Channel List (Continued)**

Channel Number	Frequency (MHz)	
	Transmit	Receive
67**	156.375	156.375
68	156.425	156.425
69	156.475	156.475
71	156.575	156.575
72	156.625	–
73	156.675	156.675
74	156.725	156.725
75	***	***
76	***	***
77**	156.875	–
78	156.925	161.525
79	156.975	161.575
80	157.025	161.625
*	157.075	161.675
*	157.125	161.725
*	157.175	161.775
84	157.225	161.825
85	157.275	161.875
86	157.325	161.925
87	157.375	161.975
88	157.425	162.025

\* Simplex channels 3, 21, 23, 61, 64, 81, 82, and 83 **cannot be lawfully used** by the general public in US waters.

\*\* Low power (1 W) only

\*\*\* Guard band

**Note:** A – in the Receive column indicates that the channel is transmit only.

# Glossary

---

<b>ACK</b>	Acknowledgment of communication.
<b>ARS</b>	Automatic Registration Service
<b>Channel</b>	A group of characteristics, such as transmit/receive frequency pairs, radio parameters, and encryption encoding.
<b>Coded Squelch</b>	Tone Private-Line™ or Digital Private-Line. Used on conventional channels to make sure you hear only the communication meant for you.
<b>Control Channel</b>	In a trunking system, one of the channels that is used to provide a continuous, two-way/data communications path between the central controller and all radios on the system.
<b>Conventional</b>	Typically refers to radio-to-radio communications, sometimes through a repeater. You share a frequency, or frequencies, with other users without the aid of a central controller to assign communication channels. Therefore, you should monitor each channel before transmitting to avoid interfering with another user who may be transmitting.
<b>Cursor</b>	A visual tracking marker (a blinking line) that indicates a location on the display.
<b>Digital Private-Line (DPL) Coded Squelch</b>	A continuous, sub-audible data signal, transmitted with the carrier.
<b>Dispatcher</b>	An individual who has radio system management duties.
<b>Failsoft</b>	A back-up system allowing you to communicate in a non-trunked, conventional mode should the trunked system fail.

<b>FCC</b>	Federal Communications Commission.
<b>Hang Up</b>	Disconnect.
<b>Home Display</b>	The first display information after the radio completes its self test.
<b>LCD</b>	Liquid-Crystal Display.
<b>Mode</b>	A programmed combination of operating parameters; for example, a channel or talkgroup.
<b>Mode-Slaving</b>	Radio programmed to automatically give the proper operation for a given mode you have selected.
<b>Monitoring (Conventional Operation)</b>	Press a programmed monitor button to listen to another user active on the channel. This way, you may be prevented from talking over someone else's conversation.
<b>Page</b>	A one-way alert, with audio and/or display messages.
<b>PIN</b>	Personal Identification Number.
<b>Push-To-Talk (PTT) button</b>	The PTT button engages the transmitter and puts the radio in transmit (send) operation when pressed. Press this button to transmit; release it to receive.
<b>Repeater</b>	A conventional radio feature, in which you talk through a receive/transmit facility (repeater) that re-transmits received signals in order to improve communications range and coverage.
<b>RF</b>	Radio Frequency. A part of the general frequency spectrum between the audio and infrared light regions (about 10 kHz to 10,000,000 MHz).

<b>RSSI</b>	<b>Received Signal Strength Indicator.</b>
<b>Squelch</b>	The muting of audio circuits when received signal levels fall below a pre-determined threshold. With carrier squelch, you hear all channel activity which exceeds the radio's preset squelch level.
<b>Standby</b>	An operating condition whereby the radio's speaker is muted but still continues to receive data.
<b>Talkgroup</b>	An organization (or group) of radio users who communicate with each other, using the same communication path.
<b>TMS</b>	Text Messaging Service.
<b>Tone Private-Line (PL) Coded Squelch</b>	A continuous sub-audible tone transmitted with the carrier.
<b>Trunking</b>	The automatic sharing of communications paths between a large number of users (see Conventional). Allows radio users to share a smaller number of frequencies because a repeater, or communications path, is assigned to a talkgroup for the length of a conversation.
<b>Zone</b>	A grouping of channels or talkgroups.

# Commercial Warranty and Service

---

## Limited Warranty

### MOTOROLA COMMUNICATION PRODUCTS

#### I. WHAT THIS WARRANTY COVERS AND FOR HOW LONG:

MOTOROLA INC. (“MOTOROLA”) warrants the MOTOROLA manufactured Communication Products listed below (“Product”) against defects in material and workmanship under normal use and service for a period of time from the date of purchase as scheduled below:

ASTRO XTL 2500 Portable Units	One (1) Year
Product Accessories	One (1) Year

Motorola, at its option, will at no charge either repair the Product (with new or reconditioned parts), replace it (with a new or reconditioned Product), or refund the purchase price of the Product during the warranty period provided it is returned in accordance with the terms of this warranty. Replaced parts or boards are warranted for the balance of the original applicable warranty period. All replaced parts of Product shall become the property of MOTOROLA.

This express limited warranty is extended by MOTOROLA to the original end user purchaser only and is not assignable or transferable to any other party. This is the complete warranty for the Product manufactured by MOTOROLA. MOTOROLA assumes no obligations or liability for additions or modifications to this warranty unless made in writing and signed by an officer of MOTOROLA. Unless made in a separate agreement between MOTOROLA and the original end user purchaser, MOTOROLA does not warrant the installation, maintenance or service of the Product.

MOTOROLA cannot be responsible in any way for any ancillary equipment not furnished by MOTOROLA which is attached to or used in connection with the Product, or for operation of the Product with any ancillary equipment, and all such equipment is expressly excluded from this warranty. Because each system which may use the Product is unique, MOTOROLA disclaims liability for range, coverage, or operation of the system as a whole under this warranty.

## **II. GENERAL PROVISIONS:**

This warranty sets forth the full extent of MOTOROLA'S responsibilities regarding the Product. Repair, replacement or refund of the purchase price, at MOTOROLA's option, is the exclusive remedy. THIS WARRANTY IS GIVEN IN LIEU OF ALL OTHER EXPRESS WARRANTIES. IMPLIED WARRANTIES, INCLUDING WITHOUT LIMITATION, IMPLIED WARRANTIES OF MERCHANTABILITY AND FITNESS FOR A PARTICULAR PURPOSE, ARE LIMITED TO THE DURATION OF THIS LIMITED WARRANTY. IN NO EVENT SHALL MOTOROLA BE LIABLE FOR DAMAGES IN EXCESS OF THE PURCHASE PRICE OF THE PRODUCT, FOR ANY LOSS OF USE, LOSS OF TIME, INCONVENIENCE, COMMERCIAL LOSS, LOST PROFITS OR SAVINGS OR OTHER INCIDENTAL, SPECIAL OR CONSEQUENTIAL DAMAGES ARISING OUT OF THE USE OR INABILITY TO USE SUCH PRODUCT, TO THE FULL EXTENT SUCH MAY BE DISCLAIMED BY LAW.

## **III. STATE LAW RIGHTS:**

SOME STATES DO NOT ALLOW THE EXCLUSION OR LIMITATION OF INCIDENTAL OR CONSEQUENTIAL DAMAGES OR LIMITATION ON HOW LONG AN IMPLIED WARRANTY LASTS, SO THE ABOVE LIMITATION OR EXCLUSIONS MAY NOT APPLY.

This warranty gives specific legal rights, and there may be other rights which may vary from state to state.

## **IV. HOW TO GET WARRANTY SERVICE:**

You must provide proof of purchase (bearing the date of purchase and Product item serial number) in order to receive warranty service and, also, deliver or send the Product item, transportation and insurance prepaid, to an authorized warranty service location. Warranty service will be provided by Motorola through one of its authorized warranty service locations. If you first contact the company which sold you the Product, it can facilitate your obtaining warranty service. You can also call Motorola at 1-888-567-7347 US/Canada.

**V. WHAT THIS WARRANTY DOES NOT COVER:**

- A) Defects or damage resulting from use of the Product in other than its normal and customary manner.
- B) Defects or damage from misuse, accident, water, or neglect.
- C) Defects or damage from improper testing, operation, maintenance, installation, alteration, modification, or adjustment.
- D) Breakage or damage to antennas unless caused directly by defects in material workmanship.
- E) A Product subjected to unauthorized Product modifications, disassemblies or repairs (including, without limitation, the addition to the Product of non-Motorola supplied equipment) which adversely affect performance of the Product or interfere with Motorola's normal warranty inspection and testing of the Product to verify any warranty claim.
- F) Product which has had the serial number removed or made illegible.
- G) Rechargeable batteries if:
  - any of the seals on the battery enclosure of cells are broken or show evidence of tampering.
  - the damage or defect is caused by charging or using the battery in equipment or service other than the Product for which it is specified.
- H) Freight costs to the repair depot.
- I) A Product which, due to illegal or unauthorized alteration of the software/firmware in the Product, does not function in accordance with MOTOROLA's published specifications or the FCC certification labeling in effect for the Product at the time the Product was initially distributed from MOTOROLA.
- J) Scratches or other cosmetic damage to Product surfaces that does not affect the operation of the Product.



- K) Normal and customary wear and tear.

**VI. PATENT AND SOFTWARE PROVISIONS:**

MOTOROLA will defend, at its own expense, any suit brought against the end user purchaser to the extent that it is based on a claim that the Product or parts infringe a United States patent, and MOTOROLA will pay those costs and damages finally awarded against the end user purchaser in any such suit which are attributable to any such claim, but such defense and payments are conditioned on the following:

- A) that MOTOROLA will be notified promptly in writing by such purchaser of any notice of such claim;
- B) that MOTOROLA will have sole control of the defense of such suit and all negotiations for its settlement or compromise; and
- C) should the Product or parts become, or in MOTOROLA's opinion be likely to become, the subject of a claim of infringement of a United States patent, that such purchaser will permit MOTOROLA, at its option and expense, either to procure for such purchaser the right to continue using the Product or parts or to replace or modify the same so that it becomes non-infringing or to grant such purchaser a credit for the Product or parts as depreciated and accept its return. The depreciation will be an equal amount per year over the lifetime of the Product or parts as established by MOTOROLA.

MOTOROLA will have no liability with respect to any claim of patent infringement which is based upon the combination of the Product or parts furnished hereunder with software, apparatus or devices not furnished by MOTOROLA, nor will MOTOROLA have any liability for the use of ancillary equipment or software not furnished by MOTOROLA which is attached to or used in connection with the Product. The foregoing states the entire liability of MOTOROLA with respect to infringement of patents by the Product or any parts thereof.

Laws in the United States and other countries preserve for MOTOROLA certain exclusive rights for copyrighted MOTOROLA software such as the exclusive rights to reproduce in copies and distribute copies of such Motorola software. MOTOROLA software may be used in only the Product in which the software was originally embodied and such software in such Product may not be replaced, copied, distributed, modified in any way, or used to produce any derivative thereof. No other use including, without limitation, alteration, modification, reproduction, distribution, or reverse engineering of such MOTOROLA software or exercise of rights in such MOTOROLA software is permitted. No license is granted by implication, estoppel or otherwise under MOTOROLA patent rights or copyrights.

**VII. GOVERNING LAW:**

This Warranty is governed by the laws of the State of Illinois, USA.

**Service**

Proper repair and maintenance procedures will assure efficient operation and long life for this product. A Motorola maintenance agreement will provide expert service to keep this and all other communication equipment in perfect operating condition. A nationwide service organization is provided by Motorola to support maintenance services. Through its maintenance and installation program, Motorola makes available the finest service to those desiring reliable, continuous communications on a contract basis. For a contract service agreement, please contact your nearest Motorola service or sales representative, or an authorized Motorola dealer.

Express Service Plus (ESP) is an optional extended service coverage plan, which provides for the repair of this product for a period of three years from the date of shipment from the factory, or the date of delivery if purchased from an authorized Motorola two-way radio dealer. For more information about ESP, contact the Motorola Radio Support Center, 2204 Galvin Drive, Elgin, IL 60123, 1-800-227-6772.

# Index

---

## Symbols

800 MHz frequencies ..... 2

## A

access

draft folder ..... 107

inbox ..... 98

sent folder ..... 108

TMS feature

use the menu ..... 93

use the preprogrammed TMS

button ..... 94

use the TMS feature button . 93

user login ..... 86

add scan list channel ..... 43

adjust

display brightness ..... 6

squelch level ..... 30

volume ..... 6

alarms

activate non-permanent ..... 45

activate permanent ..... 46

change selected ..... 46

horn and lights ..... 45

initiate

emergency ..... 33

emergency call and alarm .... 34

silent emergency ..... 35

non-permanent horn

and lights activation ..... 45

non-rearmable external ..... 47

optional external ..... 45

permanent horn and lights

activation ..... 46

rearmable external ..... 47

receiving call when on ..... 47

alert tones ..... 10

analog

mode ..... 3

trunking system

considerations ..... 111

answer

Enhanced Private Conversation

call ..... 65, 73

phone call ..... 49

ASTRO mode ..... 3

automatic scanning ..... 36

autoscan ..... 36

## B

basic operation ..... 22

box, hang up (HUB) ..... 45

button

programmable buttons ..... 9

PTT ..... 40

## C

call

answer phone ..... 49

conventional talkgroup ..... 62

emergency ..... 32

Enhanced Private

Conversation ..... 66, 74

initiate

emergency ..... 33

Enhanced Private

Conversation ..... 66, 74

from phone list ..... 50

phone number not in list ..... 51

receiving when alarms

turned on ..... 47

Call Alert page

description ..... 56

placing ..... 57

selecting unit to call ..... 56

sending ..... 56

calls, status ..... 59

change

ARS mode ..... 84

mode ..... 23

mode in current zone ..... 24

mode not in current zone ..... 25

mode priorities ..... 42

selected alarms ..... 46

zone ..... 23

control head

## Index

---

- operation .....5
- status display .....8
- conventional
  - mode .....27
  - scan list .....36
  - selecting talkgroup .....63
  - talkaround .....64
  - talkgroup calls .....62
- conventional mode, monitoring
  - activity .....29
- current zone
  - change mode .....24
  - select mode .....24
- D**
- delete
  - delete a message .....106
  - nuisance mode .....41
  - scan list channel .....44
- digital trunking system
  - considerations .....111
- direct-entry keyboard,
  - send status .....61
- display, brightness adjustment .....6
- dynamic regrouping
  - receiving an ID assignment .....77
  - requesting .....78
- E**
- edit
  - quick text message, predefined message .....104
- edit name in list .....53
- embedded signaling .....2
- emergencies, special
  - considerations .....35
- emergency call
  - initiating .....33
  - trunking .....32
- emergency call and alarm
  - description .....32
  - initiating .....34
- encryption key
  - index selection .....114
  - selecting .....112
- Enhanced Private Conversation
  - answer a call .....65, 73
  - description .....73
  - initiate call .....66, 74
  - select unit to call .....66, 74
- entering keypad characters .....55
- external alarms .....45
  - activate non-permanent horn and lights .....45
  - activate permanent horn and lights .....46
  - non-rearmable .....47
  - rearmable .....47
- F**
- failsoft .....76
- frequency ranges
  - 800 MHz .....2
- G**
- glossary .....125
- H**
- hang time .....37
- hang up box (HUB) .....45
- Home
  - mode, selecting .....27
- horn and lights alarms .....45
- HUB (hang up box) .....45
- I**
- identification, radio .....4
- inbox
  - delete message .....106
  - view message .....98
- indicator
  - N PRI (non-priority) .....37
  - PRI (priority) .....37
  - scan .....37
- initiate

- emergency alarm ..... 33  
 emergency call and alarm ..... 34  
 Enhanced Private Conversation  
   call ..... 66, 74  
   phone call from list ..... 50  
   silent emergency alarm ..... 35  
   trunked announcement ..... 83  
 interconnect, unlimited telephone 51  
 introduction to radios ..... 1
- K**
- key, encryption  
   index selection ..... 114  
   selecting ..... 112  
 keypad  
   character selection sequence .. 55  
   entering characters ..... 55
- L**
- list  
   edit name ..... 53  
   phone, place call ..... 50  
   scan ..... 36  
   store phone number ..... 52  
   telephone interconnect ..... 49  
 lock on a site, SmartZone ..... 81  
 loss indication, secure operation 111
- M**
- menu  
   TMS menu options ..... 95  
 mode  
   analog ..... 3  
   ARS Non server mode ..... 13, 84  
   ARS server mode ..... 13, 84  
   ASTRO ..... 3  
   changing ..... 24  
   changing outside current zone 25  
   priorities, changing ..... 42  
   selecting ..... 24  
   selecting Home ..... 27  
   selecting outside current zone .25
- selection ..... 23  
   slaving ..... 8  
   transmitting (conventional) ..... 27  
   transmitting (trunked) ..... 28  
   trunked ..... 8  
 monitoring  
   conventional mode activity ..... 29
- N**
- N PRI (non-priority) indicator ..... 37  
 non-priority scanning ..... 36  
 non-rearmable external alarms ... 47  
 non-ruthless preemption ..... 83  
 non-talkback scan ..... 40  
 nuisance mode  
   deleting ..... 41  
   restoring ..... 41
- O**
- operation  
   basic ..... 22  
   control head ..... 5  
   scan ..... 36  
   secure ..... 109  
   SmartZone site-button ..... 80  
   trunking ..... 72  
 operator-selectable scan ..... 36  
 out-of-range indication ..... 82
- P**
- phone numbers, preprogrammed 49  
 PIN ..... 89  
 place phone call from list ..... 50  
 placing Call Alert page ..... 57  
 power level selection ..... 28  
 powering on radio ..... 5  
 predefined  
   message, quick text message 103  
   username ..... 19, 92  
 preemption  
   non-ruthless ..... 83  
   ruthless ..... 83

## Index

---

- preprogrammed phone numbers .49
- PRI (priority) indicator .....37
- priority
  - priority flag .....102
  - priority message .....96
- priority scanning .....36
- private data .....91
- private message
  - receive .....110
  - transmit .....110
- programming scan list .....43
- PTT button .....40
- PTT-ID (Push-to-Talk identification) .....48
- Push-to-Talk identification (PTT-ID) .....48
  
- R**
- radio identification .....4
- rearmable external alarms .....47
- receive
  - call with alarms turned on .....47
  - private message .....110
  - text message .....98
- reply a message .....99
- request receipt .....103
- requesting a dynamic regrouping 78
- restore
  - mode priorities .....42
  - nuisance mode .....41
- ruthless preemption .....83
  
- S**
- scan
  - autoscan .....36
  - indicator .....37
  - non-priority .....36
  - non-talkback .....40
  - operation .....36
  - operator-selectable .....36
  - priority .....36
  - talkback .....40
  - transmit while on .....40
  - turning on .....37
- scan list
  - add a channel .....43
  - conventional .....36
  - delete a channel .....44
  - modes .....36
  - programming .....43
  - restore mode priorities .....42
  - talkgroup scan .....36
  - trunked priority .....36
  - viewing .....39
- secure operation .....109
- select
  - a channel
    - method 2: use the menu .....85
  - Call Alert page unit .....56
  - clear transmissions .....19, 87
  - conventional talkgroup .....63
  - encryption key .....112
  - encryption key index .....114
  - Home mode .....27
  - mode .....23
  - mode in current zone .....24
  - mode not in current zone .....25
  - power level .....28
  - volume level .....6
  - zone .....23
- selected-disabled units .....78
- selected-enabled units .....78
- send
  - Call Alert page .....56
  - new text message .....99
  - predefined message, quick text message .....103
  - status call .....59
- service .....132
- site trunking
  - SmartZone .....81
- site-button operation, SmartZone 80
- slaved programming .....8
- slaving, mode .....8
- smart PTT .....62
- SmartZone

- 
- description ..... 80
  - lock on a site ..... 81
  - site trunking ..... 81
  - site-button operation ..... 80
  - sqelch, adjusting level ..... 30
  - status
    - TMS status symbols ..... 96
  - status calls
    - description ..... 59
    - sending ..... 59
  - status display, control head ..... 8
  - store phone number in list ..... 52
- T**
- talk direct (mobile-to-mobile) ..... 64
  - talkback scan ..... 40
  - talkgroup scan list ..... 36
  - telephone interconnect list ..... 49
  - text messaging ..... 93
  - time-out timer ..... 48
  - tones, alert ..... 10
  - transmit
    - conventional modes ..... 27
    - private message ..... 110
    - trunked modes ..... 28
    - with scan on ..... 40
  - transmitting ..... 27, 28
  - troubleshooting ..... 115
  - trunked
    - announcement
      - capability ..... 83
      - initiate ..... 83
    - Call Alert page ..... 56
    - mode ..... 8, 28
    - priority scan list ..... 36
    - system considerations ..... 111
  - trunking
    - answer phone call ..... 49
    - emergency call ..... 32
    - Enhanced Private
      - Conversation ..... 73
    - failsoft ..... 76
    - initiating emergency call ..... 33
    - operation ..... 72
    - status calls ..... 59
    - telephone interconnect list ..... 49
    - unlimited telephone
      - interconnect ..... 51
    - turn on
      - radio ..... 5
      - scan ..... 37
- U**
- UHF frequencies ..... 2
  - units
    - select-disabled ..... 78
    - select-enabled ..... 78
    - troubleshooting ..... 115
  - unlimited telephone
    - interconnect ..... 51
  - user
    - access
      - use preprogrammed user button ..... 18, 86
      - use the menu item ..... 18, 86
    - log out ..... 91
    - login ..... 19, 87
  - username
    - direct entry, multi-tap ..... 87
    - predefined username ..... 88
- V**
- VHF frequency ..... 2
    - maritime radio use ..... 121
  - view a message ..... 98
  - viewing scan list ..... 39
  - volume, adjusting ..... 6
- W**
- warranty ..... 128
  - writing text ..... 100
- Z**
- zone selection ..... 23

# Notes



# ASTRO® XTL™ 2500 Digital Mobile Radio Control Head

## Quick Reference Card

### Product Safety and RF Exposure Compliance



Before using this product, read the operating instructions for safe usage contained in the Product Safety and RF Exposure booklet enclosed with your radio.

#### ATTENTION!

This radio is restricted to occupational use only to satisfy FCC RF energy exposure requirements. Before using this product, read the RF energy awareness information and operating instructions in the Product Safety and RF Exposure booklet enclosed with your radio (Motorola Publication part number 6881095C99) to ensure compliance with RF energy exposure limits.

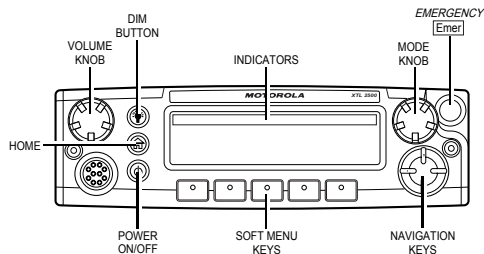

### BASIC OPERATION

#### Turning the Radio On and Off

Press the **Pwr** button once.

#### Setting the Volume and Squelch

- 1 Turn the **Vol** knob clockwise to increase volume or counterclockwise to decrease volume as desired.
- 2 On conventional modes with Private-Line or Digital Private-Line, press **MON** softkey to defeat the coded squelch.
- 3 Press **MON** softkey again to return to coded-squelch operation.
- 4 To adjust squelch level, hold **MON** softkey until a tone sounds.
- 5 Rotate the **Mode** knob clockwise to increase squelch level or counterclockwise to decrease squelch level.
- 6 Press **Home** button to save the squelch level.

#### Changing Modes

Rotate the **Mode** knob to select the desired mode.

OR

Press **Home** button to access the preprogrammed Home mode.

#### Transmitting

- 1 Press and hold the microphone **PTT** button.
- 2 When the transmit light comes on solid and no alert tones sound (or a talk-permit tone or ID sidetone sounds), speak into the microphone in a normal voice.
- 3 State your FCC call sign at the beginning of each transmission.

### Transmitting (Conventional Modes)

- 1 Press **Dir** (Direct) softkey. The **Dir** indicator lights.
- 2 Press **Dir** softkey again to return to repeater operation.

#### Activating Scan

- 1 Press **Scan** softkey to start a scan. If no activity exists, the display shows your selected mode. When a scanned channel or talkgroup becomes active, the display shows the active mode name. The **PRI** and **NPRI** indicators show priority.
- 2 Press **Scan** softkey again to stop scanning.

#### Programming a Scan List

- 1 Press **Prog** softkey followed by **Scan** softkey until the scan list is being displayed and the scan indicator blinks.
- 2 Use the navigation keys to select the mode you want to program.
- 3 Press the **Sel** softkey as indicated in the table below to add or remove the displayed mode from the scan list.
- 4 Repeat the previous steps to continue editing the list.
- 5 Press **Home** button to exit.

Press Sel	Mode	Indicator
One time	Non-Priority	<b>NPRI</b> lit
Two times	Second Priority	<b>PRI</b> lit
Three times	First Priority	<b>PRI</b> blinks
Four times	Delete from List	No indicator

#### Selecting Scan Mode Priority

- 1 Press the **Sel** softkey as indicated in the table above to designate up to two modes as priorities.
- 2 Press **Home** or **Scan** to end scan list selection.

## Sending an Emergency Alarm or Call

Press the emergency actuator (**Emer** button, footswitch, hidden pushbutton) to begin an emergency transmission.

For conventional modes, a silent or non-silent emergency alarm data transmission is sent.

For trunked modes, emergency call (priority access to a voice channel), silent or non-silent emergency alarm, or emergency alarm and call are entered.

Depending on your radio's programming, one of the emergency sequences described in the table below occur.

Alarm Type	Indications/Actions
Non-Silent	A tone sounds and the display alternates between <b>EMERGENCY</b> and the zone/channel. When acknowledged, four more tones sound and the display shows <b>ACK RECEIVED</b> , then the radio returns to normal operation.
Silent	The audio is muted and no display changes take place during the alarm.  Press the <b>PTT</b> button, or press and hold the emergency button to stop the emergency condition and unmute the radio.
Call (Trunked Modes only)	A tone sounds and the display alternates between <b>EMERGENCY</b> and the zone/channel.  Press the <b>PTT</b> button and talk.  After completing the call, press and hold the emergency actuator until a tone sounds to return to normal operation.

Alarm Type	Indications/Actions
Alarm and Call	After <b>ACK RECEIVED</b> (see Non-Silent Alarm above) is displayed, the radio has priority voice-channel access.  Press the <b>PTT</b> button and talk.  After completing the call, press and hold the emergency actuator until a tone sounds to return to normal operation.

## Sending a Status Transmission

- 1 Press **Sts** softkey. The display shows the last acknowledged status or first status name.
- 2 Use the navigation keys to select other statuses.
- 3 Press the **PTT** button to send the transmission. The display flashes the selected status/message name until the dispatcher acknowledges, at which time alert tones sound and the display shows **ACK RECEIVED**. The radio then returns to normal operation.

## Sending a Direct-Entry Enhanced Private Conversation Call

- 1 Press the **PTT** button. A single tone sounds and the display changes to **PLEASE WAIT**, followed by telephone-type ringing if the receiving unit is in service.
- 2 If the receiving unit answers, press the **PTT** button to identify yourself and proceed with your call.

**OR**

If the called unit does not respond, press **Sel** or the **PTT** button again to leave a Call Alert page message and your ID.

A single tone followed by four tones sounds if the called unit acknowledges the page.

## Initiating a Call Alert Page

- 1 Press the **Page** softkey.
- 2 Follow the instructions for initiating a Private Conversation to select a unit ID.
- 3 Press **Sel** or the **PTT** button to send a Call Alert page to the displayed ID,

**OR**

To send a Call Alert page following an Enhanced Private Conversation attempt, follow the instructions for sending a direct-entry Enhanced Private Conversation call.

## Answering a Call Alert Page

Four tones sound and **PAGE RCV** flashes on the display. The tone and display repeat every five seconds.

- 1 Press the **PTT** button,

**OR**

Initiate an Enhanced Private Conversation call to the caller.

## Selecting a Zone/Mode (Optional)

- 1 Press the **Zone** softkey and then the arrow key **▶** or **◀** to scroll to the desired zone.
- 2 Rotate the **Mode** knob to select the mode.

## Selecting a Home Zone/Home Mode

Press the **Home** button.

## Selecting Secure Mode

Press and release the **SEC** softkey. The  indicator lights up.

## Selecting an Encryption Key

- 1 Press and hold the **SEC** softkey until a tone sounds.
- 2 Use the navigation keys to scroll to **KEY SEL**.
- 3 Press **Sel** to enter the Key Selection Menu.
- 4 Use the navigation keys to select desired key.
- 5 Press **Sel** to select key.
- 6 Press **Home** or the **PTT** button to quit.

## Selecting a Key Index

- 1 Press and hold the **SEC** softkey until a tone sounds..
- 2 Use the navigation keys to scroll to **INDX SEL**.
- 3 Press **Sel** to enter the Index Selection Menu.
- 4 Use the navigation keys to select desired index.
- 5 Press **Sel** to select index.
- 6 Press **Home** or the **PTT** button to quit.

## Erasing an Encryption Key

- 1 Press and hold the **SEC** softkey until a tone sounds.
- 2 Use the navigation keys to scroll to **ERASE KY**.
- 3 Press **Sel** to enter the Key Erase Menu.
- 4 Use the navigation keys to select desired index.
- 5 Press **Sel** to select index.
- 6 Press **Home** or the **PTT** button to quit.

## DISPLAY AND LIGHT INDICATORS

<i>Display/Light</i>	<i>Meaning</i>
<b>BUSY</b> light on	Displayed conventional mode has activity on it, or selected trunked system is currently busy. Wait for callback.
<b>XMIT</b> light on	Indicates you are transmitting.
<b>Dir</b> indicator lit	Radio is in direct (mobile-to-mobile) operation.
<b>PRI, NPRI</b> indicators lit	Display shows a mode in the scan list with the indicated priority level.
<b>P</b> displayed	Telephone dialing pause. Press <b>Sel</b> softkey to continue the dialing.
<b>NO ACKNOWLEDGE</b> displayed	Unit being called with the Enhanced Private Conversation or Call Alert Page feature is not in service, or emergency alarm or status/message transmission is not acknowledged by dispatcher.
<b>PHONE BUSY</b> displayed	Trunked phone interconnect is busy.
<b>NO ANSWER</b> displayed	Unit being called with Enhanced Private Conversation or Call Alert Page does not respond, but is operational.
<b>EMERGENCY</b> displayed	Radio is in emergency alarm or call state.
<b>NO EMERGENCY</b> displayed	A mode incapable of emergency transmission has been selected.
<b>OUT OF RANGE</b> displayed	Radio is out of range of the trunking system.

## ALERT TONES

Type of Tone	Name	Explanation
1 Low-Pitched Tone	Invalid Key Alert	Feature button pressed is not valid in selected mode, or a Call Alert or emergency alarm was not acknowledged.
1 High-Pitched Tone	Central Acknowledge or Valid Key	Central controller has received request for Call Alert or emergency alarm transmission. You pressed a valid key.
4 High-Pitched Tones	Dispatcher or Mobile Unit Acknowledge	Dispatcher is acknowledging your emergency transmission. Mobile unit has received your Call Alert.
5 High-Pitched Tones		The above two acknowledge tones, heard in tandem.
2 High-Pitched Tones	Private Conversation	You have an incoming call. Press <b>Call</b> , then the <b>PTT</b> button, then talk.
4 High-Pitched Tones every 6 seconds	Call Alert Page	Call Alert page has been received.
Phone-Type Busy Tone (when pressing the <b>PTT</b> button)	System Busy	All system radio channels in use. Release the <b>PTT</b> button, and wait for callback.

## ALERT TONES (Continued)

Type of Tone	Name	Explanation
A series of low-pitched tones followed by a series of high-pitched tones.	Scan Alert On	Indicates that Scan feature is activated through the pre-programmed button or 3-Position Rotary Switch.
A series of high-pitched tones followed by a series of low-pitched tones.	Scan Alert Off	Indicates that Scan feature is deactivated through the pre-programmed button or 3-Position Rotary Switch.
Unique chirping sound	Dynamic Reprogramming	Indicates that a dynamic ID is assigned.
Unique, low-pitched chirping sound	New Message	Indicates the arrival of a new message.
Unique, high-pitched chirping sound	Priority Message	Indicates the arrival of a priority message.
2 Short High-Tones (after requesting a busy channel) upon pressing the <b>PTT</b> button)	Automatic Call Back or Talk Permit	Channel is available for previously requested transmission. System is accepting your transmission.

## ALERT TONES (Continued)

Type of Tone	Name	Explanation
Low-Pitched Tone (upon pressing the <b>PTT</b> button during Transmit) (Operation Error)	Talk Prohibit/ Out-of-Range or Time-Out Timer or Illegal Mode	Out of trunked radio system range or system is out of service. Present transmission will soon be disabled. You have entered a mode where normal system traffic will be missed, or you attempted something that is not allowed. (See examples below.)
High-Pitched Tone every 10 seconds in unmuted receive condition	Failsoft	System central controller failure. The radio reverts from trunked operation to operation similar to a conventional repeater. Others may share the channel.

**Examples:** Not exiting phone mode after a call (radio cannot receive fleet or subfleet calls), transmitting in receive-only conventional mode, trying to select a dynamic mode when no dynamic ID assignment has been made.





Motorola, Inc.  
1301 E. Algonquin Rd.  
Schaumburg, IL 60196-1078, U.S.A.

MOTOROLA, the Stylized M Logo, and ASTRO are registered in the U.S. Patent and Trademark Office. All other product or service names are the property of their respective owners.  
© 2005, 2007, 2008, 2010 by Motorola, Inc.  
All rights reserved.



**HLN6942G**