

PROFESSIONAL DIGITAL TWO-WAY RADIO &
SMARTNET® AND SMARTZONE PORTABLE RADIOS

MOTOTRBO™ XPR™ 6580 IS DISPLAY PORTABLE USER GUIDE



Declaration of Conformity

This declaration is applicable to your radio **only** if your radio is labeled with the FCC logo shown below.

DECLARATION OF CONFORMITY

Per FCC CFR 47 Part 2 Section 2.1077(a)



Responsible Party

Name: Motorola Solutions, Inc.

Address: 1303 East Algonquin Road, Schaumburg, IL 60196-1078, U.S.A.

Phone Number: 1-800-927-2744

Hereby declares that the product:

Model Name: **XPR 6580 IS**

conforms to the following regulations:

FCC Part 15, subpart B, section 15.107(a), 15.107(d) and section 15.109(a)

Class B Digital Device

As a personal computer peripheral, this device complies with Part 15 of the FCC Rules. This device complies with Industry Canada licence-exempt RSS standard(s). Operation is subject to the following two conditions:

1. This device may not cause harmful interference, and
2. This device must accept any interference received, including interference that may cause undesired operation.

Note: This equipment has been tested and found to comply with the limits for a Class B digital device, pursuant to part 15 of the FCC Rules. These limits are designed to provide reasonable protection against harmful interference in a residential installation. This equipment generates, uses and can radiate radio frequency energy and, if not installed and used in accordance with the instructions, may cause harmful interference to radio communications. However, there is no guarantee that interference will not occur in a particular installation.

If this equipment does cause harmful interference to radio or television reception, which can be determined by turning the equipment off and on, the user is encouraged to try to correct the interference by one or more of the following measures:

- Reorient or relocate the receiving antenna.
- Increase the separation between the equipment and receiver.
- Connect the equipment into an outlet on a circuit different from that to which the receiver is connected.
- Consult the dealer or an experienced radio/TV technician for help.

Contents

This User Guide contains all the information you need to use the MOTOTRBO XPR IS Series Portable Radios.

Declaration of Conformity	i
Important Safety Information	vi
Product Safety and RF Exposure Compliance	vi
Software Version	vi
Computer Software Copyrights	vii
Notes	viii
Getting Started	1
How to Use This Guide	1
What Your Dealer/System Administrator Can Tell You	1
Preparing Your Radio for Use	2
Charging the Battery	2
Attaching the Battery	3
Attaching the Antenna	3
Attaching the Belt Clip	3
Attaching the Universal Connector Cover (Dust Cover)	4
Powering Up the Radio	4
Adjusting the Volume	5

Identifying Radio Controls	5
Radio Controls You Will Be Using	6
Programmable Buttons	7
Assignable Radio Functions	7
Assignable Settings or Utility Functions	8
Accessing the Programmed Functions	8
Using the Keypad	9
Push-To-Talk (PTT) Button	10
Switching Between Conventional and Trunking Mode	10
Identifying Status Indicators	11
Display Icons	11
Call Icons	12
Main Menu Icons	12
In-Menu Icons	12
LED Indicator	13
Audio Tones	13
Indicator Tones	13
Making and Receiving Calls	14
Selecting a Zone	14
Selecting a Radio Channel	15
Receiving and Responding to a Radio Call	15
Receiving and Responding to a Group Call	15
Receiving and Responding to a Private Call	16
Receiving and Responding to a Phone Call	17



Making a Radio Call	17	Making a Private Call from Contacts	29
Making a Call with the Channel Selector Knob ..	18	Making a Private Call by Alias Search	30
Making a Group Call	18	Call Indicator Settings	30
Making a Private Call	18	Activating and Deactivating Call Ringers for	
Making an Enhanced Private Call	19	Private Calls	30
Making a Phone Call	20	Escalating Alarm Tone Volume	31
Sending a Status Call	20	Call Log Features	31
Using the Dynamic Regrouping Feature	21	Viewing Recent Calls	31
Talkaround	22	Storing an Alias or ID from the Received Call List	32
Monitoring Features	23	Deleting a Call from a Call List	32
Monitoring a Channel	23	Call Alert Operation	33
Permanent Monitor	23	Receiving and Acknowledging a Call Alert	33
Advanced Features	24	Making a Call Alert from the Contacts List	33
Scan Lists	24	Making a Call Alert with the One Touch Call	
Viewing an Entry in the Scan List	24	Button	34
Editing the Scan List	25	Emergency Operation	34
Adding a New Entry to the Scan List	25	Receiving an Emergency Call	35
Deleting an Entry from the Scan List	25	Receiving an Emergency Alarm	35
Setting and Editing Priority for an Entry in		Receiving an Emergency Alarm with Call	35
the Scan List	26	Sending an Emergency Call	36
Scan	26	Sending an Emergency Alarm	36
Starting and Stopping Scan	27	Sending an Emergency Alarm with Call	37
Responding to a Transmission During a Scan ..	27	Sending an Emergency Alarm with Voice to	
Deleting a Nuisance Channel	28	Follow	38
Restoring a Nuisance Channel	28	Reinitiating an Emergency Mode	39
Contacts Settings	29	Exiting Emergency Mode	39

Dual-Tone Multi Frequency (DTMF)	40	Carry Devices	50
Trunking System Controls	40	Chargers	50
Using the Failsoft System	40	Earbuds and Earpieces	50
Going Out of Range	41	Headsets and Headset Accessories	50
Using the Site Trunking Feature	41	Remote Speaker Microphones	50
Locking and Unlocking a Site	41	Miscellaneous Accessories	50
Viewing and Changing a Site	42	Batteries and Chargers Warranty	51
Viewing and Changing a Site	42	Limited Warranty	52
Changing the Current Site	42		
Utilities	43		
Locking and Unlocking the Keypad	43		
Turning Keypad Tones On or Off	43		
Setting the Squelch Level	44		
Controlling the Display Backlight	44		
Turning the Radio Tones/Alerts On or Off	45		
Turning the Talk Permit Tone On or Off	45		
Turning the LED Indicator On or Off	46		
Turning the Introduction Screen On or Off	46		
Accessing General Radio Information	47		
Accessing the Battery Information	47		
Checking the Radio ID	48		
Checking the Firmware Version	48		
Checking the Codeplug Version	48		
Accessories	49		
Antennas	49		
Batteries	49		

Important Safety Information

Product Safety and RF Exposure Compliance



Caution

Before using this product, read the operating instructions for safe usage contained in the Product Safety and RF Exposure booklet enclosed with your radio.

ATTENTION!

This radio is restricted to occupational use only to satisfy FCC RF energy exposure requirements.

Before using this product, read the RF energy awareness information and operating instructions in the Product Safety and RF Exposure booklet enclosed with your radio (Motorola Publication part number 6881095C98) to ensure compliance with RF energy exposure limits.

Keep this User Guide and the Product Safety and RF Exposure booklet in a safe place and make them available to other operators in case the radio is passed on to other people.

To assure the safety and regulatory compliance of the XPR 6580 IS, the radio must be repaired only at Motorola service facilities. Please call Motorola at 800-422-4210 for the address and contact information of your nearest service center.

For a list of Motorola-approved antennas, batteries, and other accessories, visit the following website:

<http://www.motorolasolutions.com>

Any modification to this device, not expressly authorized by Motorola, may void the user's authority to operate this device.

Under Industry Canada regulations, this radio transmitter may only operate using an antenna of a type and maximum (or lesser) gain approved for the transmitter by Industry Canada. To reduce potential radio interference to other users, the antenna type and its gain should be so chosen that the equivalent isotropically radiated power (e.i.r.p.) is not more than that necessary for successful communication.

Software Version

All the features described in the following sections are supported by the radio's software version **R01.00.00** or later.

See ***Checking the Firmware Version*** on page 48 to determine your radio's software version.

Check with your dealer or system administrator for more details of all the features supported.

Computer Software Copyrights

The Motorola products described in this manual may include copyrighted Motorola computer programs stored in semiconductor memories or other media. Laws in the United States and other countries preserve for Motorola certain exclusive rights for copyrighted computer programs including, but not limited to, the exclusive right to copy or reproduce in any form the copyrighted computer program. Accordingly, any copyrighted Motorola computer programs contained in the Motorola products described in this manual may not be copied, reproduced, modified, reverse-engineered, or distributed in any manner without the express written permission of Motorola. Furthermore, the purchase of Motorola

products shall not be deemed to grant either directly or by implication, estoppel, or otherwise, any license under the copyrights, patents or patent applications of Motorola, except for the normal non-exclusive license to use that arises by operation of law in the sale of a product.

The AMBE+2TM voice coding Technology embodied in this product is protected by intellectual property rights including patent rights, copyrights and trade secrets of Digital Voice Systems, Inc.

This voice coding Technology is licensed solely for use within this Communications Equipment. The user of this Technology is explicitly prohibited from attempting to decompile, reverse engineer, or disassemble the Object Code, or in any other way convert the Object Code into a human-readable form.

U.S. Pat. Nos. #5,870,405, #5,826,222, #5,754,974, #5,701,390, #5,715,365, #5,649,050, #5,630,011, #5,581,656, #5,517,511, #5,491,772, #5,247,579, #5,226,084 and #5,195,166.

Notes

Notes

viii

English

Getting Started

Take a moment to review the following:

How to Use This Guide page 1

What Your Dealer/System Administrator Can Tell You . page 1

■ How to Use This Guide

This User Guide covers the basic operation of MOTOTRBO XPR 6580 IS.

However, your dealer or system administrator may have customized your radio for your specific needs. Check with your dealer or system administrator for more information.

Throughout this publication, a note is shown for Conventional mode and Trunking mode only features to differentiate the features according to the two modes.

For features that are available in both Conventional and Trunking modes, no note is shown.

■ What Your Dealer/System Administrator Can Tell You

You can consult your dealer or system administrator about the following:

- Is your radio programmed with any preset conventional channels?
- Which buttons have been programmed to access other features?
- What optional accessories may suit your needs?

Preparing Your Radio for Use

Assemble your radio by following these steps:

Charging the Battery	page 2
Attaching the Battery	page 3
Attaching the Antenna	page 3
Attaching the Belt Clip	page 3
Attaching the Universal Connector Cover (Dust Cover)	page 4
Powering Up the Radio	page 4
Adjusting the Volume	page 5

Charging the Battery

Your radio is powered by a Lithium-Ion (Li-Ion) battery. To avoid damage and comply with warranty terms, charge the battery using a Motorola charger *exactly* as described in the charger user guide.

If battery is attached to your radio, ensure that your radio is turned off before charging.

Charge a new battery 14 to 16 hours before initial use for best performance.

IMPORTANT: **ALWAYS** charge your IMPRES battery with the IMPRES charger. Using a conventional charger causes irrecoverable loss of IMPRES battery data. As a result, the battery functions as a non-IMPRES battery and cannot display the data on your radio. Additionally, it voids your IMPRES battery warranty, although the standard battery warranty still applies.



Caution

Charge battery only in non-hazardous areas. After battery is charged, allow your radio to rest for at least, 3 minutes. See *Batteries* on page 49 for the available batteries.

■ Attaching the Battery

Align the battery with the rails on the back of the radio. Move the battery latch into unlock position and hold, and slide battery upward. Release battery latch into lock position.

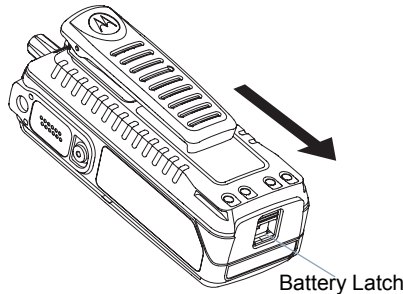
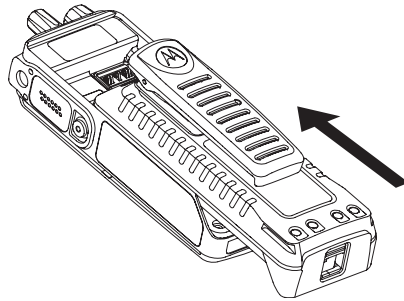

To remove the battery, turn the radio off. Move the battery latch into unlock position and hold, and slide the battery down and off the rails.



Caution

Do not change battery in gas and dust environments. Replace battery only in non-hazardous areas. See *Batteries* on page 49 for the available batteries.

■ Attaching the Antenna



With the radio turned off, set the antenna in its receptacle and turn clockwise.



To remove the antenna, turn the antenna counterclockwise. Make sure you turn off the radio and remove the universal connector cover first.



Caution

If antenna needs to be replaced, ensure that only MOTOTRBO antennas are used. Neglecting this will damage your radio. See **Antennas** on page 49 for the available antenna.

■ Attaching the Belt Clip

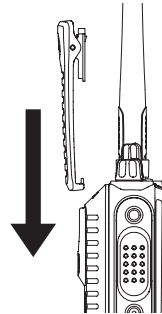

Align the grooves on the clip with those on the battery and press downward until you hear a click.

To remove the clip, press the belt clip tab away from the battery. Then slide the clip upward and away from the radio.

■ Attaching the Universal Connector Cover (Dust Cover)

The universal connector is located on the antenna side of the radio. It is used to connect MOTOTRBO accessories to the radio.

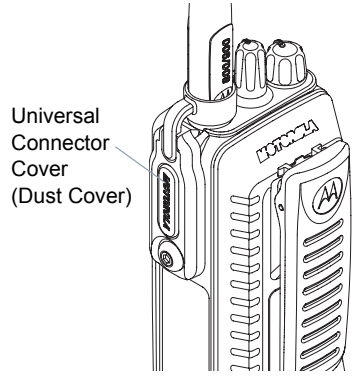

Place the universal connector cover loop over the attached antenna. Slide it all the way down to the base of the antenna.

Insert the hooked end of the cover into the slots above the universal connector. Press downward on the cover to seat the lower tab properly into the RF connector.

Turn the thumbscrew clockwise to secure the connector cover to the radio.

To remove the universal connector cover, press down on the cover and turn the thumbscrew counterclockwise. Lift the cover up, slide the connector cover loop upwards, and remove it from the attached antenna.

Replace the universal connector cover when the connector is not in use.

■ Powering Up the Radio

Rotate the **On/Off/Volume Control Knob** clockwise until you hear a click. You see **Motorola** and **MOTOTRBO (TM)** on the radio's display momentarily.

The LED blinks green and the Home screen lights up if the backlight setting is set to turn on automatically.

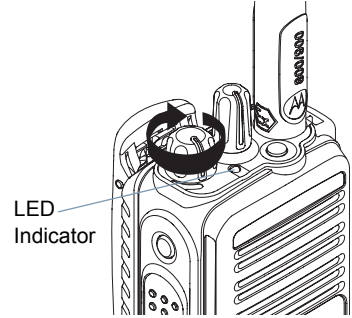

NOTE: The Home screen does not light up during a power-up if the LED indicator is disabled (see **Turning the LED Indicator On or Off** on page 46).

A brief tone sounds, indicating that the power-up test is successful.

NOTE: There is no power-up tone if the radio tones/alerts function is disabled (see **Turning the Radio Tones/Alerts On or Off** on page 45).

If your radio does not power up, check your battery. Make sure that it is charged and properly attached. If your radio still does not power up, contact your dealer or system administrator.

To turn off the radio, rotate this knob counterclockwise until you hear a click. You see a brief Powering Down on the radio's display.

■ Adjusting the Volume

To increase the volume, turn the **On/Off/Volume Control Knob** clockwise.

To decrease the volume, turn this knob counterclockwise.

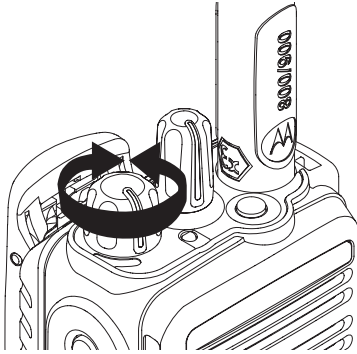

Identifying Radio Controls

Take a moment to review the following:

Radio Controls You Will Be Using	page 6
Programmable Buttons	page 7
Accessing the Programmed Functions	page 8
Using the Keypad	page 9
Push-To-Talk (PTT) Button	page 10
Switching Between Conventional and Trunking Mode	page 10

■ Radio Controls You Will Be Using

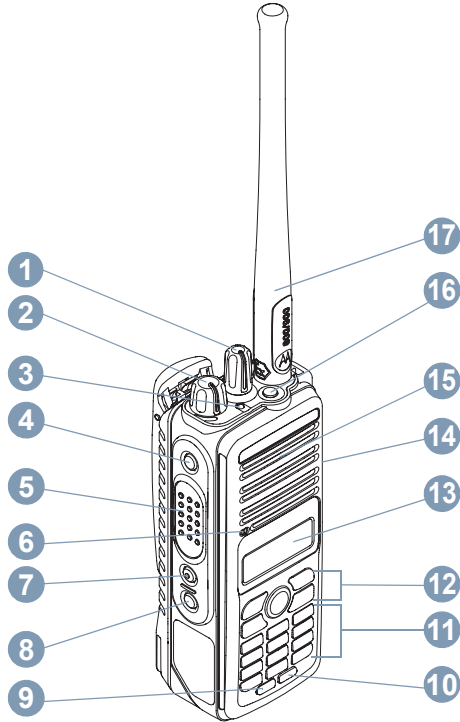

- 1 Channel Selector Knob
- 2 On/Off/Volume Control Knob
- 3 LED Indicator
- 4 Side Button 1*
- 5 Push-to-Talk (**PTT**) Button
- 6 Microphone
- 7 Side Button 2*
- 8 Side Button 3*
- 9 Front Button P1*
- 10 Front Button P2*
- 11 Keypad
- 12 Menu Navigation Keys
- 13 Display
- 14 Universal Connector for Accessories
- 15 Speaker
- 16 Emergency Button*
- 17 Antenna

* These buttons are programmable.

■ Programmable Buttons

Your dealer or system administrator can program the programmable buttons as shortcuts to radio functions or preset channels/groups depending on the duration of a button press:

- Press – Pressing and releasing rapidly.
- Long press – Pressing and holding for the programmed duration (between 0.25 seconds and 3.75 seconds).
- Hold down – Keeping the button pressed.

📄 Assignable Radio Functions

Battery Indicator – Checks the battery charge status via the LED.

Call* – Initiates a private call by keying in or selecting any subscriber ID and accepts incoming private calls.

Call Alert* – Allows selection of radio ID number to initiate a call alert.

Contacts – Provides direct access to the Contacts list.

Emergency* – Depending on the programming, initiates or cancels an emergency alarm or call.

Message Update* – Selects a message update to send to the dispatcher.

Monitor** – Monitors a selected channel for activity.

Nuisance Delete – Temporarily removes an unwanted channel from the scan list until the radio is powered off and on again, or the scan is turned off and on again.

One Touch Call* – Directly initiates a predefined Message, Status, Private Call, Phone Call, or a Call Alert to a target radio.

Permanent Monitor** – Monitors a selected channel for all radio traffic until function is turned off.

Phone – Initiates a phone call by keying in or selecting any phone ID and accepts incoming phone calls.

Repeater/Talkaround** – Toggles between using a repeater and communicating directly with another radio.

Scan – Toggles scan on or off.

Site Display* – Displays current site on the radio display.

Site Lock On/Off* – Toggles the automatic site roam on or off in Smart Zone operation.

Site Search* – Starts site search in SmartZone operation.

Status Update* – Selects a status update to send to the dispatcher.

Transmit Inhibit – Prevents transmission when enabled.

Zone – Allows selection from a list of zones.

** A trunking only feature*

*** A conventional only feature*

📄 Assignable Settings or Utility Functions

All Tones/Alerts – Toggles all tones and alerts on or off.

Backlight – Toggles display backlight and front panel buttons backlight on or off.

Keypad Lock – Toggles keypad between locked and unlocked.

Power Level – Toggles transmit power level between high and low.

Squelch** – Toggles squelch level between tight and normal.

* A trunking only feature

** A conventional only feature







■ Accessing the Programmed Functions

You can access various radio functions through one of the following ways:

- A short or long press of the relevant programmable buttons.



OR

- Use the Menu Navigation Buttons as follows:
 - 1 To access the menu, press the  button. Press the appropriate **Menu Scroll** button ( or ) to access the menu functions.
 - 2 To select a function or enter a sub-menu, press the  button.
 - 3 To go back one menu level, or to return to the previous screen, press the  button. Long press the  button to return to the Home screen.

NOTE: Your radio automatically exits the menu after a period of inactivity and returns to your Home screen.

■ Using the Keypad

You can use the 3 x 4 alphanumeric keypad to access your radio's features. You can use the keypad to enter subscriber aliases or IDs. Many characters require that you press a key multiple times. The table below shows the number of times a key needs to be pressed to generate the required character.

Key	Number of Times Key is Pressed												
	1	2	3	4	5	6	7	8	9	10	11	12	13
1 ,.?	1	.	,	?	!	@	&	'	%	-	:	*	#
2 abc	A	B	C	2									
3 def	D	E	F	3									
4 ghi	G	H	I	4									
5 jkl	J	K	L	5									
6 mno	M	N	O	6									
7 pqrs	P	Q	R	S	7								
8 tuv	T	U	V	8									
9 wxyz	W	X	Y	Z	9								
0 CAPS	0	NOTE: Press to enter "0" and long press to activate the CAPS lock. Another long press to turn off the CAPS lock.											
* DEL	* or del	NOTE: Press during text entry to delete the character. Press during numeric entry to enter a "**".											
# —	# or space	NOTE: Press during text entry to insert a space. Press during numeric entry to enter a "#".											

■ Push-To-Talk (PTT) Button

The **PTT** button on the side of the radio serves two basic purposes:

- While a call is in progress, the **PTT** button allows the radio to transmit to other radios in the call.

Press and hold down **PTT** button to talk. Release the **PTT** button to listen.

The microphone is activated when the **PTT** button is pressed.

- While a call is not in progress, the **PTT** button is used to make a new call (see **Making a Radio Call** on page 17).

*If the Talk Permit Tone is enabled (see **Turning the Talk Permit Tone On or Off** on page 45), wait until the short alert tone ends before talking.*

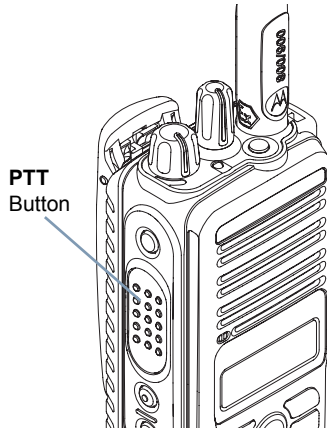

■ Switching Between Conventional and Trunking Mode

Each channel in your radio can be configured as a conventional channel or a trunking channel. Use the Channel Selector Knob to switch between a conventional or a trunking channel.

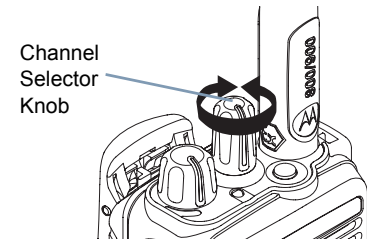

When switching from trunking to conventional mode, certain features are unavailable. Icons for the trunking features reflect this change by appearing “grayed out”. Disabled features are hidden in the menu.

Your radio also has features available in both conventional and trunking mode. However, the minor differences in the way each feature works does **NOT** affect the performance of your radio.

Identifying Status Indicators

Your radio indicates its operational status through the following:

Display Icons page 11
 Call Icons page 12
 Main Menu Icons page 12
 In-Menu Icons page 12
 LED Indicator page 13
 Audio Tones page 13
 Indicator Tones page 13

■ Display Icons

The full dot matrix, black and white, liquid crystal display (LCD) of your radio shows radio status, text entries, and menu entries.

The following are icons that appear on the radio's display.



Received Signal Strength Indicator (RSSI)

NOTE: This is a trunking only feature.

The number of bars displayed represents the radio signal strength. Four bars indicate the strongest signal.



Monitor

NOTE: This is a conventional only feature.
 Selected channel is being monitored.



Power Level

Radio is set at Low power.



Radio is set at High power.

Tones Disable

Tones are turned off.



Scan

Scan feature is enabled.



Priority Scan

NOTE: This is a trunking only feature.
 Radio detects activity on channel/group designated as Priority 1 (if • is blinking) or Priority 2 (if • is steady).



Emergency

NOTE: This is a trunking only feature.
 Radio is in Emergency mode.



Talkaround

NOTE: This is a conventional only feature.
 In the absence of a repeater, radio is currently configured for direct radio to radio communication.



Battery

The number of bars (0 – 4) shown indicates the charge remaining in the battery.
 Blinks when the battery is low.

■ Call Icons

The following icons appear on the radio's display during a call. These icons also appear in the Contacts list to indicate ID type.



Private Call

NOTE: This is a trunking only feature. Indicates a Private Call in progress. In the Contacts list, it indicates a subscriber alias (name) or ID (number).



Dispatcher Call

Indicates a Dispatcher Call in progress.



Phone Call

Indicates a Phone Call in progress.

■ Main Menu Icons

The following are icons that appear on the radio's display.



Contacts

Selects the Contacts menu.



Scan

Selects the Scan menu.



Zone

Allows selection from a list of zones.



TMS

Selects the Status and Message menu.



Call Log

Selects the Call Log menu.



Utilities

Selects the Utilities menu.

■ In-Menu Icons

The following are icons that appear on the radio's display.



Left Arrow

Navigates to the left of the items in the display.



Right Arrow

Navigates to the right of the items in the display.



Scan Priority 1

Detects activity on channel/group designated as Priority 1.



Scan Priority 2

Detects activity on channel/group designated as Priority 2.

■ LED Indicator

The LED indicator shows the operational status of your radio.

Blinking red – Radio is transmitting at low battery condition, receiving an emergency transmission or has failed the self-test upon powering up.

Solid yellow – Radio is in Permanent Monitor mode, at a fair battery condition, monitoring a channel, or requested trunked call has no voice channel or target is busy.

Blinking yellow – Radio is scanning for activity or receiving a Call Alert.

Solid green – Radio is transmitting or at a good battery condition.

Blinking green – Radio is powering up, receiving a call or data, or detecting activity over the air.

NOTE: Upon a **PTT** button press, if the radio is programmed for polite operation, the radio automatically determines whether a transmission is permitted via a Talk Permit or a Talk Denial tone.

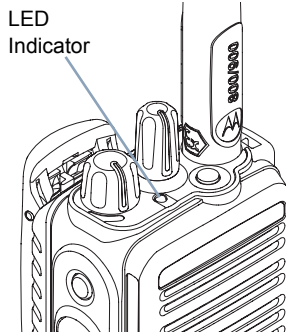



■ Audio Tones

Alert tones provide you with audible indications of the radio's status or the radio's response to data received.

Continuous Tone  A monotone sound. Sounds continuously until termination.

Periodic Tone  Sounds periodically depending on the duration set by the radio. Tone starts, stops, and repeats itself.

Repetitive Tone  A single tone that repeats itself until it is terminated by the user.

Momentary Tone  Sounds only once for a short period of time defined by the radio.

■ Indicator Tones

High-pitched tone  Low-pitched tone 

 Positive Indicator Tone

 Negative Indicator Tone

Making and Receiving Calls

Once you understand how your MOTOTRBO Portable is configured, you are ready to use your radio.

Use this navigation guide to familiarize yourself with the basic Call features:

Selecting a Zone	page 14
Selecting a Radio Channel	page 15
Receiving and Responding to a Radio Call.	page 15
Making a Radio Call	page 17
Talkaround	page 22
Monitoring Features	page 23

Selecting a Zone

A zone is a group of channels. Your radio supports up to 130 zones, with a maximum of 16 channels per zone.

Use the following procedure to select a zone.



Procedure:

Press the programmed **Zone** button and proceed to step 3.



OR

Follow the procedure below.

- 1  to access the menu.

- 2  or  to **Zone** and press  to select.

- 3 The current zone is displayed and indicated by a ✓.

- 4  or  to the required zone and press  to select.

- 5 The display shows <Zone> Selected momentarily and returns to the selected zone screen.

NOTE: The zones appear in alphabetical order, if named.

The **Zone** main menu option will not appear, if the radio is not configured for zones.

■ Selecting a Radio Channel

Procedure:

Once the required zone is displayed (if you have multiple zones in your radio), turn the programmed Channel Selector Knob to select the channel, subscriber alias or ID, or group alias or ID.

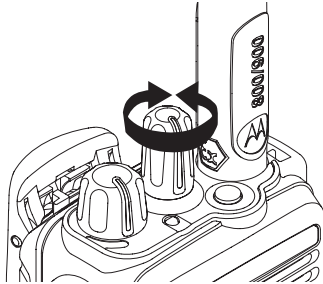

■ Receiving and Responding to a Radio Call

Once you have selected the required channel and/or zone, you can proceed to receive and respond to calls.

The LED lights up solid green while the radio is transmitting and blinks green when the radio is receiving.

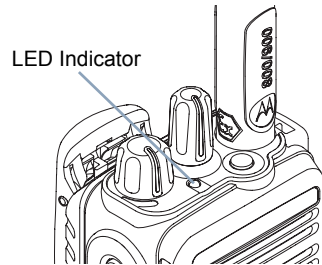

📄 Receiving and Responding to a Group Call

NOTE: This is a trunking only feature.

To receive a call from a group of users, your radio must be configured as part of that group.

Procedure:

When you receive a Group Call (while on the Home screen):

- 1 The LED blinks green.
- 2 The first line of the display shows the alias or ID of the caller, and the RSSI icon. The second line displays the related personality alias.
- 3 Hold the radio vertically 1 to 2 inches (2.5 to 5.0 cm) from your mouth.
- 4 Press the **PTT** button to respond to the call. The LED lights up solid green.
- 5 Wait for the Talk Permit Tone to finish (if enabled) and speak clearly into the microphone.
- 6 Release the **PTT** button to listen.
- 7 If there is no voice activity for a predetermined period of time, the call ends.

See **Making a Group Call** on page 18 for details on making a Group Call.

NOTE: If the radio receives a Group Call while not on the Home screen, it remains on its current screen prior to answering the call.

Long press the  button to go to the Home screen to view the caller alias before replying.

Receiving and Responding to a Private Call

NOTE: This is a trunking only feature.

A Private Call is a call from an individual radio to another individual radio.

There are two types of Private Calls. The first type is called Enhanced Private Call, where a radio presence check is performed prior to setting up the call, while the other, Basic Private Call, sets up the call immediately.

Procedure:

When you receive a Private Call:

- 1 A tone sounds and the LED blinks green.
- 2 The first line of the display shows the subscriber alias or ID, and the Private Call and RSSI icons. The second line displays *Response*.

- 3 Hold the radio vertically 1 to 2 inches (2.5 to 5.0 cm) from your mouth.
- 4 Press  to select *Response*.
OR
Press the **Call** button within 20 seconds after the call indicators begin.
- 5 The first line of the display shows the subscriber alias or ID, and the Private Call and RSSI icons. The second line displays *Private Call*.
- 6 Press and hold the **PTT** button to respond.
- 7 The first line of the display shows *Calling*. The second line displays the subscriber alias or ID, and the Private Call icon.
- 8 When you are connected, the first line of the display shows the subscriber alias or ID, and the Private Call and RSSI icons. The second line displays *Private Call*.
- 9 Release the **PTT** button to listen.

See ***Making a Private Call*** on page 18 for details on making a Private Call.

Receiving and Responding to a Phone Call

A Phone Call is a call similar to a standard phone call from a landline phone.

Procedure:

When you receive a Phone Call:

- 1 A tone sounds and the LED blinks green.
- 2 The first line of the display shows **Phone Call** and the RSSI icon. The second line displays **Response**.
- 3 Hold the radio vertically 1 to 2 inches (2.5 to 5.0 cm) from your mouth.
- 4 Press  to select **Response**.
- 5 The first line of the display shows **Phone Call**. The second line displays **Responding**.
- 6 Press and hold the **PTT** button to talk. Release the **PTT** button to listen.

See **Making a Phone Call** on page 20 for details on making a Phone Call.

■ Making a Radio Call

You can select a zone, channel, subscriber ID, or group by using:

- The Channel Selector Knob
- A programmed **One Touch Call** button*
- The Contacts list from Contacts menu or via **Call** button (see **Contacts Settings** on page 29)*
- Manual Dial (via **Call** button) – This method is for Private Calls only and is dialed using the keypad (see **Making a Private Call from Contacts** on page 29)*

* A trunking only feature

Making a Call with the Channel Selector Knob

Making a Group Call

NOTE: This is a trunking only feature.

To make a call to a group of users, your radio must be configured as part of that group.

Procedure:

- 1 Turn the Channel Selector Knob to select the channel with the targeted talkgroup.
- 2 Hold the radio vertically 1 to 2 inches (2.5 to 5.0 cm) from your mouth.
- 3 Press the **PTT** button to make the call. The LED lights up solid green.
- 4 Wait for the Talk Permit Tone to finish (if enabled) and speak clearly into the microphone.
- 5 Release the **PTT** button to listen.

Making a Private Call

NOTE: This is a trunking only feature.

Procedure:

Press the programmed **Quick Access (One-Touch) Private Call** button to dial the programmed ID (number) and proceed to Step 4.

OR

Follow the procedure below.

- 1 Press the **Call** button to call.
- 2 The display shows the call list, you can scroll through and select the required ID (any target ID or last transmitted or received ID) or go to the manual dial option to enter the required ID.
- 3 Press the **PTT** button to start the Private Call. The LED lights up solid green.
- 4 The first line of the display shows **Calling**. The second line displays the target alias or ID and the Private Call icon.

- 5 Hold the radio vertically 1 to 2 inches (2.5 to 5.0 cm) from your mouth.
- 6 When you are connected, the first line of the display shows the ID or alias of the target radio and the Private Call icon. The second line displays `Private Call`. Press and hold the **PTT** button to talk. Release the **PTT** button to listen.
OR
If no acknowledgment is received, the display shows `No Answer`.

*You can also make a Private Call via Contacts (see **Making a Private Call from Contacts** on page 29) or perform a quick alphanumeric search for the required alias via a keypad entry (see **Making a Private Call by Alias Search** on page 30).*

Making an Enhanced Private Call

NOTE: This is a trunking only feature.

This feature allows you to send an individual Call Alert page if there is no answer from the target radio.

NOTE: Your radio must be programmed to allow you to use this feature.

Procedure:

Press the programmed **Quick Access (One-Touch) Private Call** button to dial the programmed ID (number) and proceed to Step 4.

OR

Follow the procedure below.

- 1 Press the **Call** button to Call.
- 2 The display shows the call list, you can scroll through and select the required ID (any target ID or last transmitted or received ID) or go to the manual dial option to enter the required ID.
- 3 Press the **PTT** button to initiate the Private Call request.
- 4 The first line of the display shows `Calling`. The second line displays the target alias or ID and the Private Call icon.
- 5 When you are connected, the first line of the display shows the ID or alias of the target radio and Private Call icon. The second line displays `Private Call`. You may hear the Private Call voice if the target is talking.
- 6 Hold the radio vertically 1 to 2 inches (2.5 to 5.0 cm) from your mouth. Press and hold the **PTT** button to talk. Release the **PTT** button to listen.
OR
If no acknowledgment is received, the display shows `No Answer`.

Making a Phone Call

This feature allows you to make calls similar to standard phone calls to a mobile or landline phone. Your radio must be programmed to allow you to use **Delayed Access Buffered Dialing** method for below procedure.

Procedure:

Press the programmed **Quick Access (One-Touch) Private Call** button to dial the programmed phone number and proceed to Step 4.

OR

Follow the procedure below.

- 1 Press **Phone** button.

- 2 The display shows the phone list, you can scroll through and select the required ID (any target ID or last transmitted or received ID) or go to the manual dial option to enter the required ID.

- 3 Press the **PTT** button to initiate the Phone Call request. The LED lights up solid green.

- 4 The first line of the display shows **Calling**. The second line displays the target alias or ID and the Phone Call icon. The dial tone will be heard, then DTMF tone sounded for phone ID Transmission.

- 5 After phone number transmission, the first line of the display shows the phone alias or number and the Phone Call icon, the second line displays **Phone Call**, and you may hear the voice from the telephone user.

- 6 When your call is answered, hold the radio vertically 1 to 2 inches (2.5 to 5.0 cm) from your mouth.

- 7 Press the **PTT** button to talk.

- 8 Release the **PTT** button to listen.

Sending a Status Call

NOTE: This is a trunking only feature.

This feature allows you to send data calls to the dispatcher about a predefined status.

Each status can have up to a 14-character name. A maximum of eight status conditions is possible.



NOTE: The radio automatically exits the feature, if the time-out timer is enabled, when the radio is left idle and the timer expires. You will hear the Menu Inactive Exit Tone upon feature exit.

Procedure:



Press the programmed **Status** button and proceed to Step 3.

OR

Follow the procedure below.

- 1  or  to **Status** and press  to select.

- 2 The display shows the last acknowledged status call, or the first status in the list.

- 3  or  to the required status.

- 4 Press  to send the status.

- 5 When the dispatcher acknowledges, four tones sound and the display shows **Ack Received**. The radio returns to normal dispatch operation.

OR

If no acknowledgment is received, a low-pitched tone sounds and the display shows **No Acknowledge**.

*No traffic is heard on trunked channels while Status Calls is selected. If the radio detects no Status Call activity for six seconds, an alert tone sounds until you press Home or the **PTT** button.*

 **Using the Dynamic Regrouping Feature**

NOTE: This is a trunking only feature.

This feature allows the dispatcher to temporarily reassign selected radios to a single special channel so they can communicate with each other. This feature is typically used during special operations and is enabled by a qualified radio technician.

You will not notice whether your radio has this feature enabled until a dynamic regrouping command is sent by the dispatcher.

NOTE: If you try to access a zone or channel that has been reserved by the dispatcher as a dynamically regrouped mode for other users, an invalid tone sounds.

Procedure:

- 1 When your radio is dynamically regrouped, it automatically switches to the dynamically regrouped channel. A “gurgle” tone sounds and the display shows the dynamically regrouped channel name.

- 2 Press the **PTT** button to talk. Release **PTT** button to listen.

When the dispatcher cancels dynamic regrouping, the radio automatically returns to the zone and channel that you were using before the radio was dynamically regrouped.

■ Talkaround

NOTE: This is a conventional only feature.





You can continue to communicate when your repeater is not operating, or when your radio is out of the repeater's range but within talking range of other radios. This is called "talkaround".







Procedure:

Press the programmed **Repeater/Talkaround** button to toggle between talkaround and repeater modes.

OR

Follow the procedure below.

- 1  to access the menu.
 - 2  or  to **Utilities** and press  to select.
-

- 3  or  to **Radio Settings** and press  to select.
 - 4  or  to **Talkaround** and press  to select.
 - 5 You see **Turn On** if the radio is currently in Repeater mode.
OR
You see **Turn Off** if the radio is currently in Talkaround mode.
 - 6 Press  to select.
 - 7 The display shows **Talkaround On**.
OR
The display shows **Talkaround Off**.
 - 8 The screen automatically returns to the previous menu.
-

The Talkaround setting is retained even after powering down.

■ Monitoring Features

NOTE: This is a conventional only feature.

📄 Monitoring a Channel

Use the Monitor feature to make sure a channel is clear before transmitting.

Procedure:

- 1 Press and hold the programmed **Monitor** button and listen for activity. The monitor icon appears on the display.
- 2 You hear radio activity or total silence, depending on how your radio is programmed.
- 3 When you hear “white noise” (that is, the channel is free), press the **PTT** button to talk and release it to listen. The LED lights up solid yellow.

📄 Permanent Monitor

Use the Permanent Monitor feature to continuously monitor a selected channel for activity.

Procedure:

- 1 Press the programmed **Permanent Monitor** button.
- 2 Radio sounds an alert tone, the LED lights up solid yellow, and the display shows `Permanent Monitor On`. The Monitor icon appears on the display.
- 3 Press the programmed **Permanent Monitor** button to exit Permanent Monitor mode.
- 4 Radio sounds an alert tone, the LED turns off, and display shows `Permanent Monitor Off`.

Advanced Features

Use this navigation guide to learn more about advanced features available with your radio:

Scan Lists	page 24
Scan	page 26
Contacts Settings	page 29
Call Indicator Settings	page 30
Call Log Features	page 31
Call Alert Operation	page 33
Emergency Operation	page 34
Dual-Tone Multi Frequency (DTMF)	page 40
Trunking System Controls	page 40
Utilities	page 43

Scan Lists









Scan lists are created and assigned to individual channels/groups. Your radio scans for voice activity by cycling through the channel/group sequence specified in the scan list for the current channel/group.

Your radio can support up to 128 scan lists, with a maximum of 16 members in a list. You can add, delete, or prioritize channels by editing a scan list.

NOTE: Priority scan is only available in trunking mode.

Viewing an Entry in the Scan List

Procedure:

- 1  to access the menu.
- 2  or  to Scan and press  to select.
- 3  or  to View/Edit List and press  to select.
- 4 Use  or  to view each member on the list.

*The priority icon appears left of the member's alias, if set, to indicate whether the member is on a Priority 1 or Priority 2 channel list. You **cannot** have multiple Priority 1 or Priority 2 channels in a scan list.*



*There is no priority icon if priority is set to **None**.*



Editing the Scan List



Adding a New Entry to the Scan List



Procedure:



- 1  to access the menu.

 - 2  or  to Scan and press  to select.







 - 3  or  to View/Edit List and press  to select.

 - 4  or  to Add Member and press  to select.

 - 5  or  to the required alias or ID and press  to select.

 - 6  or  to the required priority level and press  to select.



 - 7 The display shows Entry Saved, followed immediately by Add Another?.



 - 8  or  to Yes and press  to select, to add another entry, and repeat steps 5 and 6.
- OR**
-  or  to No and press  to select to save the current list.



Deleting an Entry from the Scan List



Procedure:







- 1  to access the menu.

 - 2  or  to Scan and press  to select.

 - 3  or  to View/Edit List and press  to select.

 - 4  or  to the required alias or ID and press  to select.

 - 5  or  to Delete and press  to select.



 - 6 At Delete Entry?,  or  to Yes and press  to select, to delete the entry. The display shows Entry Deleted.
- OR**
-  or  to No and press  to select to return to the previous screen.
- 7 Repeat steps 4 to 6 to delete other entries.



After deleting all required aliases or IDs, long press  to return to the Home screen.



Setting and Editing Priority for an Entry in the Scan List



Procedure:



- 1  to access the menu.

- 2  or  to Scan and press  to select.

- 3  or  to View/Edit List and press  to select.

- 4  or  to the required alias or ID and press  to select.

- 5  or  to Edit Priority and press  to select.

- 6  or  to the required priority level and press  to select.

- 7 The display shows Entry Saved before returning to the previous screen.

- 8 The priority icon appears left of the member's name.

*There is no priority icon if priority is set to **None**.*

■ Scan

When you start a scan, your radio cycles through the programmed scan list for the current channel looking for voice activity.

The LED blinks yellow and you see the scan icon on the display.

There are two ways of initiating scan:

- **Main Channel Scan (Manual):** Your radio scans all the channels/groups in your scan list. On entering scan, your radio may – depending on the settings – automatically start on the last scanned “active” channel/group or on the channel where scan was initiated.
- **Auto Scan (Automatic):** Your radio automatically starts scanning when you select a channel/group that has Auto Scan enabled.

Starting and Stopping Scan

Procedure:



Press the programmed **Scan** button to start or stop Scan.

OR

Follow the procedure below.

- 1 Use the Channel Selector Knob to select a channel programmed with a scan list.

- 2  to access the menu.

- 3  or  to Scan and press  to select.

- 4 The display shows **Turn On** if scan is disabled.
OR
The display shows **Turn Off** if scan is enabled.

- 5 Press  to select.

- 6 The LED blinks yellow and the scan icon is displayed when Scan is enabled.
OR
The LED turns off and the scan icon is not displayed when Scan is disabled.

Responding to a Transmission During a Scan

During scanning, your radio stops on a channel/group where activity is detected. The radio stays on that channel for a programmed time period known as “hang time”.

Procedure:

- 1 Hold the radio vertically 1 to 2 inches (2.5 to 5.0 cm) from your mouth.

- 2 Press the **PTT** button during hang time. The LED lights up solid green.

- 3 Wait for the Talk Permit Tone to finish (if enabled) and speak clearly into the microphone.

- 4 Release the **PTT** button to listen.

- 5 If you do not respond within the hang time, the radio returns to scanning other channels/groups.

Deleting a Nuisance Channel

If a channel continually generates unwanted calls or noise (termed a “nuisance” channel), you can temporarily remove the unwanted channel from the scan list.

This capability does not apply to the channel designated as the Selected Channel.

Procedure:

- 1 When your radio “locks on to” an unwanted or nuisance channel, press the programmed **Nuisance Delete** button until you hear a tone.

- 2 Release the **Nuisance Delete** button. The nuisance channel is deleted.

*Deleting a “nuisance” channel is **only** possible through the programmed **Nuisance Delete** button. This feature is **not** accessible through the menu.*

Restoring a Nuisance Channel

Procedure:

To restore the deleted nuisance channel, do **ONE** of the following:

- Turn the radio off and then powering it on again, **OR**
- Stop and restart a scan via the programmed **Scan** button or menu, **OR**
- Change the channel via the Channel Selector Knob.

■ Contacts Settings

Contacts provides “address-book” capabilities on your radio. Each entry corresponds to an alias or ID that you use to initiate a call.

Additionally, each entry, depending on context, associates with **ONE** of four types of calls: Phone Call, Private Call, Selective Call or Call Alert.

PC Call and Dispatch Call are data-related. They are only available with the applications. Refer to the data applications documentation for more information.

Your radio supports one Contacts list, with a maximum of 250 members for Radio Call entry and a maximum of 50 members for Phone Call entry.

Each entry within Contacts displays the following information:



- Call Type
- Call Alias
- Call ID



NOTE: You can add, delete, or edit subscriber IDs for the Contacts list.

Making a Private Call from Contacts

Procedure:

- 1  to access the menu.

- 2  or  to `Contacts` and press  to select. The entries are alphabetically sorted.

- 3  or  to the required subscriber alias or ID.

- 4 Press the **PTT** button to start the Private Call. The first line displays `Calling`. The second line displays the target alias or ID and the Private Call icon.

- 5 When you are connected, the display shows the ID or alias of the target radio and the Private Call icon. `Private Call` is displayed on second line. Talk Permit Tone will be heard if enabled.

- 6 Hold the radio vertically 1 to 2 inches (2.5 to 5.0 cm) from your mouth.

- 7 Press and hold the PTT button to talk. Release the **PTT** button to listen.



Making a Private Call by Alias Search

You can also use alias or alphanumeric search to retrieve the required subscriber alias.



This feature is only applicable while in Contacts.

Procedure:

- 1  to access the menu.

- 2  or  to **Contacts** and press  to select. The entries are alphabetically sorted.

- 3 Key in the first character of the alias.

- 4  or  to the required alias.

- 5 Press the **PTT** button to start the Private Call. The first line displays **Calling**. The second line displays the target alias or ID and the Private Call Icon.

- 6 When you are connected, the display shows the ID or alias of the target radio and the Private Call icon. **Private Call** is displayed on the second line. Talk Permit Tone will be heard if enabled.

- 7 Hold the radio vertically 1 to 2 inches (2.5 to 5.0 cm) from your mouth.

- 8 Press and hold the **PTT** button to talk. Release the **PTT** button to listen.

Call Indicator Settings



Activating and Deactivating Call Ringers for Private Calls



NOTE: This is a trunking only feature.



You can turn on or off the ringing tones for a received Private Call.



Procedure:



- 1  to access the menu.

- 2  or  to **Utilities** and press  to select.

- 3  or  to **Radio Settings** and press  to select.

- 4  or  to **Tones/Alerts** and press  to select.

- 5  or  to **Call Ringers** and press  to select.

- 6  or  to **Private Call** and press  to select.

- 7 The display shows **Turn On**. Press  to enable Call Ringers for Private Calls. The display shows **Private Call Ringer On**.

- OR**

- The display shows **Turn Off**. Press  to disable Call Ringers for Private Calls. The display shows **Private Call Ringer Off**.



NOTE: To activate or deactivate call ringer for Selective Call/ Call Alert/Phone Call, follow similar steps as above.



Escalating Alarm Tone Volume



Your radio can be programmed to continually alert you when a radio call remains unanswered. This is done by automatically increasing the alarm tone volume over time. This feature is known as Escalert.



Procedure:



- 1  to access the menu.

- 2  or  to Utilities and press  to select.

- 3  or  to Radio Settings and press  to select.

- 4  or  to Tones/Alerts and press  to select.

- 5  or  to Escalert and press  to select.

- 6 The display shows Turn On. Press  to enable Escalert. The display shows Escalert On.
OR
The display shows Turn Off. Press  to disable Escalert. The display shows Escalert Off.

■ Call Log Features

Your radio keeps track of all recent incoming and outgoing Radio Calls, and outgoing Phone Calls. Use the call log feature to view and manage recent calls.

NOTE: Incoming and outgoing Radio Calls are trunking only features.

You can perform the following tasks in each of your call lists:



- Store ID to Contacts
- Delete



Viewing Recent Calls

The lists are Radio Rcvd, Radio Dialed, and Phone Dialed.



Procedure:

- 1  to access the menu.

- 2  or  to Call Log and press  to select.















- 3  or  to preferred list and press  to select.

- 4 The display shows the most recent entry at the top of the list.

- 5  or  to view the list.

Storing an Alias or ID from the Received Call List

















Procedure:

- 1  to access the menu.
- 2  or  to Call Log and press  to select.
- 3  or  to Radio Rcvd and press  to select.
- 4  or  to the required received call alias or ID and press  to select.
- 5  or  to Store and press  to select.
- 6 A blinking cursor appears. If needed, key in the alias for that ID and press .
- 7 The display shows Contact Saved.

You can also store an ID without an alias.

Deleting a Call from a Call List

Procedure:

- 1  to access the menu.
- 2  or  to Call Log and press  to select.
- 3  or  to the required list and press  to select.
- 4  or  to the required alias or ID and press  to select.
- 5  or  to Delete Entry? and press  to select.
- 6 Press  to select Yes to delete the entry. The display shows Entry Deleted.
OR
 or  to No to return to the previous screen.

When you select a call list and it contains no entries, the display shows *List Empty*, and sounds a low tone if Keypad Tones are turned on (see **Turning Keypad Tones On or Off** on page 43).

■ Call Alert Operation

NOTE: This is a trunking only feature.

Call Alert paging enables you to alert a specific radio user to call you back when they are able to do so.

This feature is applicable for subscriber aliases or IDs only and is accessible through the menu via Contacts or manual dial.

📄 Receiving and Acknowledging a Call Alert











When you receive a Call Alert page, you see `Call Alert` that alternates with the alias or ID of the calling radio on the display.

Procedure:

- 1 You hear a repetitive tone. The LED blinks yellow.
 - 2 Press and release the **PTT** button to acknowledge the alert.
OR
Press  to select `Ignore?` and to exit the Call Alert.
-

📄 Making a Call Alert from the Contacts List

Procedure:

- 1  to access the menu.
 - 2  or  to `Contacts` and press  to select.
 - 3  or  to the required subscriber alias or ID and press  to select.
 - 4  or  to `Call Alert` and press  to select.
 - 5 The display shows `Call Alert: <Subscriber Alias or ID>`, indicating that the Call Alert has been sent.
 - 6 The LED lights up solid green when your radio is sending the Call Alert.
 - 7 If the Call Alert acknowledgment is received, a tone sounds and the display shows `Call Alert Successful`.
OR
If the Call Alert acknowledgment is not received, a tone sounds and the display shows `Call Alert Failed`.
-

Making a Call Alert with the One Touch Call Button

Procedure:

- 1 Press the programmed **One Touch Call** button to make a Call Alert to the predefined alias or ID.
- 2 The display shows `Call Alert: <Subscriber Alias or ID>`, indicating that the Call Alert has been sent.
- 3 The LED lights up solid green when your radio is sending the Call Alert.
- 4 If the Call Alert acknowledgment is received, a tone sounds and the display shows `Call Alert Successful`.
OR
If the Call Alert acknowledgment is not received, a tone sounds and the display shows `Call Alert Failed`.

■ Emergency Operation

NOTE: This is a trunking only feature.

The Emergency feature is used to indicate a critical situation. You are able to initiate an Emergency at any time on any screen display even when there is activity on the current channel.

Your radio supports the following Emergency modes:

- Emergency Call
- Emergency Alarm
- Emergency Alarm with Call
- Emergency Alarm with Voice to Follow

In addition, each mode has the following types:

- Regular – Radio transmits an alarm signal and shows audio and/or visual indicators.
- Silent – Radio transmits an alarm signal without any audio or visual indicators. There will be no response (call) from the target radio until you press the **PTT** button to initiate the call.
- Silent with Voice – Radio transmits an alarm signal and is able to receive an incoming call, without any audio or visual indicators, until you press the **PTT** button to initiate, or respond to, the call.

Only **ONE** of the Emergency modes above can be assigned to the programmed **Emergency** button.

Receiving an Emergency Call

Procedure:

- 1 When receiving an Emergency Call, the first line of the display shows the alias or ID of the caller. The second line displays **Emergency**.
- 2 The LED blinks red and you hear a voice from the Emergency Call initiating radio.
- 3 If the voice channel is lost, the Emergency Call ends.

Receiving an Emergency Alarm

Procedure:

- 1 When receiving an Emergency Alarm, the first line of the display shows the alias or ID of the sender. The second line displays **Alarm Rcvd**.
- 2 A tone sounds and the LED blinks red.
- 3 Press  to clear the alarm indication.
OR
If no button is pressed, the alarm indication exits automatically after a short duration.

When your radio receives an Emergency Alarm, it displays the Emergency Alarm received indications for approximately, 10 seconds.

Receiving an Emergency Alarm with Call

Procedure:

- 1 When receiving an Emergency Alarm with Call, the first line of the display shows the alias or ID of the sender. The second line displays **Alarm Rcvd**.
- 2 A tone sounds and the LED blinks red.
- 3 Press  to clear the alarm indication.
OR
If no button is pressed, the alarm indication exits automatically after a short duration.
- 4 You hear a voice from the Emergency Alarm with Call initiating radio.
- 5 Hold the radio vertically 1 to 2 inches (2.5 to 5.0 cm) from your mouth.
- 6 Press **PTT** button to initiate a call with the emergency initiating radio. The LED lights up solid green.
- 7 Wait for the Talk Permit Tone to finish (if enabled) and speak clearly into the microphone.
- 8 Release the **PTT** button to listen. When the emergency initiating radio responds, the LED blinks green.

Sending an Emergency Call

This feature gives your radio priority access on a channel.

NOTE: The radio operates in the normal dispatch manner while in Emergency Call, except, if enabled, it returns to one of the following:

- **Tactical/Non-Revert** – You talk on the channel you selected before you entered the emergency state.
- **Non-Tactical/Revert** – You talk on a programmed emergency channel. The emergency alarm is sent on this same channel.

Procedure:

- 1 Press the programmed **Emergency** button.
- 2 The display shows **Emergency** on the second line. The LED lights up solid green and the Emergency icon appears on the Home screen display.
OR
The radio sounds a low-pitched tone, if the selected channel does not support emergency. Select a channel that shows **Emergency**.
- 3 Hold the radio vertically 1 to 2 inches (2.5 to 5.0 cm) from your mouth.

- 4 Press and hold the **PTT** button. Speak clearly into the microphone.
- 5 Release the **PTT** button to end the transmission and wait for a response from the dispatcher.
- 6 Press and hold the programmed **Emergency** button for about a second to exit the Emergency Call mode.

If your radio is set to Silent, it will not have any audio or visual indicators related to the Emergency feature.

Sending an Emergency Alarm

This feature allows you to send an Emergency Alarm, a non-voice signal, which triggers an alert indication on another radio.

Procedure:

- 1 Press the programmed **Emergency** button.
- 2 The display shows **Sending Alarm** on the second line. The LED lights up solid green and the Emergency icon appears on the Home screen display. An Emergency Enter Tone sounds upon each retry.

- 3 When an Emergency Alarm acknowledgment is received, the Emergency Acknowledgment Tone sounds and the LED blinks green. The display shows `Emergency Alarm Successful`.

OR

If your radio does not receive an Emergency Alarm acknowledgment, and after all retries have been exhausted, a tone sounds and the display shows `Emergency Alarm Failed`.

- 4 Radio exits the Emergency Alarm mode and returns to the Home screen.

If your radio is set to Silent, it will not have any audio or visual indicators related to the Emergency feature.

Sending an Emergency Alarm with Call

This feature allows you to send an Emergency Alarm to another radio. Upon acknowledgment, both radios can communicate over a programmed Emergency channel.

Procedure:

- 1 Press the programmed **Emergency** button.

- 2 The display shows `Sending Alarm` on the second line. The LED lights up solid green and the Emergency icon appears on the Home screen display. An Emergency Enter Tone sounds upon each retry.

- 3 When an Emergency Alarm acknowledgment is received, the Emergency Acknowledgment Tone sounds and the LED blinks green. The display shows `Emergency Alarm Successful`.

- 4 Hold the radio vertically 1 to 2 inches (2.5 to 5.0 cm) from your mouth.

- 5 Press **PTT** button to make the call. The display shows `Emergency` on the second line. The LED lights up solid green and the Emergency icon appears on the Home screen display.

- 6 Wait for the Talk Permit Tone to finish (if enabled) and speak clearly into the microphone.

- 7 Release the **PTT** button to listen.

- 8 Long press the programmed **Emergency** button to exit the Emergency mode.

- 9 The radio returns to the Home screen.

*If your radio is set to Silent, it will not have any audio or visual indicators related to the Emergency feature, or receive any response (call) from the target radio, until you press the **PTT** button to initiate the call.*

*If your radio is set to Silent with Voice, it will not have any audio or visual indicators related to the Emergency feature, or when you are receiving a call from the target radio. The indicators will only appear once you press the **PTT** button to initiate, or respond to, the call.*

Sending an Emergency Alarm with Voice to Follow

This feature allows you to send an Emergency Alarm to another radio. Upon acknowledgment, your radio's microphone is automatically activated, allowing you to communicate with the other radio without pressing the **PTT** button.

This activated microphone state is also known as "hot mic".

If you press the **PTT** button during the programmed hot mic transmission period, the radio ignores the **PTT** press and remains in Emergency mode.

NOTE: If you press the **PTT** button during hot mic, and continue to press it after the hot mic duration expires, the radio continues to transmit until you release the **PTT** button.

Procedure:

- 1 Press the programmed **Emergency** button.
- 2 The display shows `Sending Alarm`. The LED lights up solid green and the Emergency icon is displayed.
- 3 Once the display shows `Emergency Alarm Successful`, speak clearly into the microphone. When hot mic has been enabled, the radio automatically transmits without a **PTT** press until the hot mic duration expires.
- 4 While transmitting, the LED lights up solid green and the Emergency icon appears on the display.
- 5 Once the hot mic duration expires, the radio automatically stops transmitting. To transmit again, press the **PTT** button.

*If your radio is set to Silent, it will not have any audio or visual indicators related to the Emergency feature, or receive any response from the target radio, until the programmed hot mic transmission period is over, and you press the **PTT** button.*

*If your radio is set to Silent with Voice, it will not have any audio or visual indicators related to the Emergency feature when you are making the call with hot mic, or when the target radio responds after the programmed hot mic transmission period is over. The indicators will only appear when you press the **PTT** button.*

NOTE: If the Emergency Alarm request fails, the radio returns to the Home screen.

Reinitiating an Emergency Mode

There are two instances where this can happen:

- You change the channel while the radio is in Emergency mode. This exits the Emergency mode. If Emergency Alarm is enabled on this new channel, the radio reinitiates Emergency. If Emergency is not supported on this new channel, the radio displays **No Emergency**.
- You press the programmed **Emergency** button during an Emergency initiation/transmission state. This causes the radio to exit this state, and to reinitiate Emergency.

Exiting Emergency Mode

Your radio exits Emergency mode when **ONE** of the following occurs:

- Emergency Alarm acknowledgment is received (for **Emergency Alarm** only), **OR**
- All retries to send the alarm have been exhausted (for **Emergency Alarm** only), **OR**
- The programmed **Emergency** button is long pressed.

NOTE: If your radio is powered off, it exits the Emergency mode. The radio will not reinitiate the Emergency mode automatically when it is turned on again.

■ Dual-Tone Multi Frequency (DTMF)

The Dual-Tone Multi Frequency (DTMF) feature allows the radio to operate in a radio system with an interface to telephone systems.

Procedure:

To initiate a DTMF call.

- 1 Press and hold the **PTT** button.
- 2 Enter the desired number.

*You can turn off the DTMF tone by disabling all radio tones and alerts (see **Turning the Radio Tones/Alerts On or Off** on page 45).*

■ Trunking System Controls

NOTE: This is a trunking only feature.

Using the Failsoft System

The failsoft system ensures continuous radio communications during a trunked system failure. If a trunking system fails completely, the radio goes into failsoft operation and automatically switches to its failsoft channel.

Procedure:

- 1 During failsoft operation, your radio transmits and receives in conventional operation on a predetermined frequency.
- 2 A medium-pitched tone sounds every 10 seconds and the display shows `Failsoft`, which alternates with the personality alias.

When the trunking system returns to normal operation, your radio automatically leaves failsoft operation and returns to trunked operation.

Going Out of Range

When your radio goes out of the range of the system, it can no longer lock onto a control channel.

Procedure:

- 1 A low-pitched tone sounds.

AND/OR

The display shows the currently selected channel combination and *Out of Range*.

- 2 Your radio remains in this out-of-range condition until:
It locks onto a control channel.

OR

It locks onto a failsoft channel.

OR

It is turned off.

Using the Site Trunking Feature

If the zone controller loses communication with any site, that site reverts to site trunking.

The display shows the currently selected channel combination and *Site Trunking*.

NOTE: When this occurs, you can communicate only with other radios within your trunking site.

Locking and Unlocking a Site

This feature allows your radio to lock onto a specific site and not roam among wide-area talkgroup sites. This feature should be used with caution, since it inhibits roaming to another site in a wide-area system.



Procedure:



Use the preprogrammed Site Lock/Unlock button to toggle the lock state between locked and unlocked.



OR

Follow the procedure below.

- 1  to access the menu.

- 2  or  to *Utilities* and press  to select.

- 3  or  to *Radio Settings* and press  to select.

- 4  or  to *Site Lock* and press  to select.

- 5 You see *Turn On* if the site is currently in unlocked state.
OR
You see *Turn Off* if the site is currently in locked state.

- 6 Press  to select.

- 7 The display shows *Site Locked*.
OR
The display shows *Site Unlocked*.

- 8 The radio saves the new site lock state and returns to the Home screen.
-

Viewing and Changing a Site

This feature allows you to view the number of the current site or force your radio to change to a new one.

Viewing and Changing a Site

Procedure:

- 1 Press the preprogrammed **Site Display** button (it could be short press or long press based on the configuration of the programmable button).

- 2 The display momentarily shows the name of the current site and its corresponding received signal strength indicator (RSSI).

Changing the Current Site

Procedure:

- 1 Press the preprogrammed **Site Search** button (it could be short press or long press based on the configuration of the programmable button).

- 2 A tone sounds and the display momentarily shows Scanning site.

- 3 When the radio finds a new site, it returns to the Home screen.



■ Utilities



📄 Locking and Unlocking the Keypad



You can lock your radio's keypad to avoid inadvertent key entry.

Procedure:

- 1  to access the menu.

- 2  or  to Utilities and press  to select.

- 3  or  to Radio Settings and press  to select.

- 4  or  to Keypad Lock and press  to select.

- 5 The display shows Keypad Locked and returns to the Home screen.

- 6 To unlock the keypad, press  followed by *.



- 7 The display shows Keypad Unlocked and returns to the Home screen.



📄 Turning Keypad Tones On or Off



You can enable and disable keypad tones if needed.



Procedure:



- 1  to access the menu.

- 2  or  to Utilities and press  to select.

- 3  or  to Radio Settings and press  to select.

- 4  or  to Tones/Alerts and press  to select.

- 5  or  to Keypad Tones and press  to select.

- 6 The display shows Turn On. Press  to enable keypad tones. The display shows Keypad Tone On.
OR
The display shows Turn Off. Press  to disable keypad tones. The display shows Keypad Tone Off.

Setting the Squelch Level

NOTE: This is a conventional only feature.

You can adjust your radio's squelch level to filter out unwanted calls with low signal strength or channels that have a higher than normal background noise.

Settings: Normal is the default. Tight filters out (unwanted) calls and/or background noise. However, calls from remote locations may also be filtered out.



Procedure:



Press the programmed **Squelch** button to toggle squelch level between normal and tight.



OR

Follow the procedure below.

- 1  to access the menu.

- 2  or  to Utilities and press  to select.

- 3  or  to Radio Settings and press  to select.

- 4  or  to Squelch and press  to select.

- 5 Choose either Tight or Normal and press  to select.

- 6 Screen returns to the previous menu.

Controlling the Display Backlight

You can enable or disable the radio's display backlight as needed. The setting also affects the Menu Navigation Buttons and keypad backlighting accordingly.



Procedure:



Press the programmed **Backlight** button to toggle the backlight settings.



OR



Follow the procedure below.

- 1  to access the menu.

- 2  or  to Utilities and press  to select.

- 3  or  to Radio Settings and press  to select.

- 4  or  to Backlight and press  to select.

- 5 The display shows Auto On. Press  to enable the display backlight. The display shows Backlight Auto On.
OR
The display shows Turn Off. Press  to disable the display backlight. The display shows Backlight Turn Off.

*The display backlight and keypad backlighting are automatically turned off if the LED indicator is disabled (see **Turning the LED Indicator On or Off** on page 46).*

Turning the Radio Tones/Alerts On or Off

You can enable and disable all radio tones and alerts (except for the incoming Emergency alert tone) if needed.



Procedure:



Press the programmed **All Tones/Alerts** button to toggle all tones on or off.



OR



Follow the procedure below.

- 1  to access the menu.

- 2  or  to Utilities and press  to select.

- 3  or  to Radio Settings and press  to select.

- 4  or  to Tones/Alerts and press  to select.

- 5  or  to All Tones and press  to select.

- 6 The display shows Turn On. Press  to enable all tones and alerts. The display shows All Tones On.

OR



The display shows Turn Off. Press  to disable all tones and alerts. The display shows All Tones Off.



Turning the Talk Permit Tone On or Off



You can enable and disable the Talk Permit Tone if needed.



Procedure:



- 1  to access the menu.

 - 2  or  to Utilities and press  to select.

 - 3  or  to Radio Settings and press  to select.

 - 4  or  to Tones/Alerts and press  to select.













 - 5  or  to Talk Permit and press  to select.

 - 6 The display shows Turn On. Press  to enable the Talk Permit Tone. The display shows Talk Permit Tone On.
- OR**
- The display shows Turn Off. Press  to disable the Talk Permit Tone. The display shows Talk Permit Tone Off.
-

Turning the LED Indicator On or Off

You can enable and disable the LED Indicator if needed.

Procedure:













- 1  to access the menu.
- 2  or  to Utilities and press  to select.
- 3  or  to Radio Settings and press  to select.
- 4  or  to LED Indicator and press  to select.
- 5 The display shows Turn On. Press  to enable the LED Indicator. The display shows All LEDs On.
OR
The display shows Turn Off. Press  to disable the LED Indicator. The display shows All LEDs Off.

*The display backlight, buttons, and keypad backlighting are automatically turned off if the LED indicator is disabled (see **Controlling the Display Backlight** on page 44).*

Turning the Introduction Screen On or Off

You can enable and disable the Introduction Screen if needed.



Procedure:

- 1  to access the menu.
- 2  or  to Utilities and press  to select.
- 3  or  to Radio Settings and press  to select.
- 4  or  to Intro Screen and press  to select.
- 5 The display shows Turn On. Press  to enable the Introduction Screen. The display shows Intro Screen On.
OR
The display shows Turn Off. Press  to disable the Introduction Screen. The display shows Intro Screen Off.

Accessing General Radio Information

Your radio contains information on the following:











- Battery
- Radio ID
- Software Version
- Codeplug Version

NOTE: Press  at any time to return to the previous screen or long press  to return to the Home screen.

Accessing the Battery Information

Displays information on your radio battery.

Procedure:

- 1  to access the menu.
- 2  or  to Utilities and press  to select.
- 3  or  to Radio Info and press  to select.
- 4  or  to Battery Info and press  to select.



- 5 The display shows the battery information.

OR

For **IMPRES** batteries **ONLY**: The display reads Recondition Battery if the battery requires reconditioning in an IMPRES charger.

After the reconditioning process, the display then shows the battery information.

*For **IMPRES** batteries **ONLY**:*

Press  or  to access the Remaining Capacity, First Used, or Service Life option screen:











- *Select Remaining Capacity to view battery capacity level, indicated by a horizontal bar and percentage reading.*
- *Select First Used to view the date when battery is first used.*
- *Select Service Life to view the potential and current capacity of the battery.*

Checking the Radio ID

NOTE: This is a trunking only feature.

Displays the ID of your radio.





Procedure:



- 1  to access the menu.
- 2  or  to *Utilities* and press  to select.
- 3  or  to *Radio Info* and press  to select.
- 4  or  to *My Number* and press  to select.
- 5 The display shows the radio ID.



Checking the Firmware Version

Displays the firmware version on your radio.

Procedure:

- 1  to access the menu.
- 2  or  to *Utilities* and press  to select.

- 3  or  to *Radio Info* and press  to select.

- 4  or  to *Firmware Ver.* and press  to select.

- 5 The display shows the current firmware version.



Checking the Codeplug Version



Displays the codeplug version on your radio.

Procedure:

- 1  to access the menu.

- 2  or  to *Utilities* and press  to select.

- 3  or  to *Radio Info* and press  to select.

- 4  or  to *CP Ver.* and press  to select.

- 5 The display shows the current codeplug version.

Accessories

Your radio is compatible with the accessories listed in this chapter. Contact your dealer or system administrator for details.

Antennas	page 49
Batteries	page 49
Carry Devices	page 50
Chargers	page 50
Earbuds and Earpieces	page 50
Headsets and Headset Accessories	page 50
Remote Speaker Microphones	page 50
Miscellaneous Accessories	page 50

Antennas

The diagram on the right shows the location of the color indicator for the following antennas. See the footnote at the end of the list for the color.



- CSA GPS Helical Antenna⁹, 806 - 941 MHz (PMAF4005_)
- Whip Antenna¹, 800 MHz (NAF5087_)
- Whip Antenna⁵, 900 MHz (NAF5088_)

Color Code:

1 Red	3 Black	5 Blue	7 Brown	9 Purple
2 Green	4 Yellow	6 White	8 Orange	

Batteries

- MOTOTRBO CSA/IECEEx/ATEX IMPRES Li-Ion, 1750 mAh (NNTN7789_)*
- MOTOTRBO CSA 157 IMPRES Li-Ion, 1750 mAh (NNTN8287_)**

* For use with radio PMUF1473AKNBA and PMUF1473AJNBD Only

** For use with radio PMUF1473BKNBA and PMUF1473BJNBD Only

■ Carry Devices

- Hard Leather Carry Case with 3-Inch Swivel Belt Loop for Display Radio (PMLN5606_)
- Soft Leather Carry Case with 3-Inch Swivel Belt Loop for Display Radio (PMLN5607_)
- 2.5-Inch Swivel Belt Loop (For Use with PMLN5606_ and PMLN5607_) (PMLN5610_)
- 3-Inch Replacement Swivel Belt Loop (PMLN5611_)
- ATEX CSA Belt Clip for 2.5-Inch Belt Width (PMLN5134_)

■ Chargers

- IMPRES Multi-Unit Charger (WPLN4212_)
- IMPRES Multi-Unit Charger with Displays (WPLN4219_)
- IMPRES Single-Unit Charger (WPLN4232_)

■ Earbuds and Earpieces

- Receive-Only Earpiece (RLN4941_)**

■ Headsets and Headset Accessories

- Behind the Head Heavy Duty Headset (PMLN5275_)**
- Standard Hardhat Mount Headset 24NRR (for use with NNTN8378_) (NNTN8379_)**
- Standard Hardhat Mount Headset, 26NRR (for use with NNTN8378_) (NNTN8380_)**
- Receive-Only Headset (for use with PMMN4050_) (RMN4054)**

■ Remote Speaker Microphones

- IMPRES ATEX CSA Remote Speaker Microphone (PMMN4067_)
- IMPRES Noise Canceling RSM with audio jack (PMMN4050_)**

■ Miscellaneous Accessories

- Universal Connector Dust Cover for MOTOTRBO ATEX CSA (PMLN5649_)
- CSA Push-to-Talk Adapter (NNTN8378_)**

** For use with radio PMUF1473BKNBA and PMUF1473BJNBD Only

Batteries and Chargers Warranty

The Workmanship Warranty

The workmanship warranty guarantees against defects in workmanship under normal use and service.

All MOTOTRBO Batteries	Two (2) Years
IMPRES Chargers (Single-Unit and Multi-Unit, Non-Display)	Two (2) Years
IMPRES Chargers (Multi-Unit with Display)	One (1) Year

The Capacity Warranty

The capacity warranty guarantees 80% of the rated capacity for the warranty duration.

MOTOTRBO CSA 157 and CSA/IECEX/ATEX Lithium-Ion IMPRES Batteries	18 Months
--	-----------

Limited Warranty

MOTOROLA COMMUNICATION PRODUCTS

I. WHAT THIS WARRANTY COVERS AND FOR HOW LONG:

MOTOROLA INC. ("MOTOROLA") warrants the MOTOROLA manufactured Communication Products listed below ("Product") against defects in material and workmanship under normal use and service for a period of time from the date of purchase as scheduled below:

XPR IS Series Portable Radios	Two (2) Years
Product Accessories (Excluding Batteries and Chargers)	One (1) Year

MOTOROLA, at its option, will at no charge either repair the Product (with new or reconditioned parts), replace it (with a new or reconditioned Product), or refund the purchase price of the Product during the warranty period provided it is returned in accordance with the terms of this warranty. Replaced parts or boards are warranted for the balance of the original applicable warranty period. All replaced parts of Product shall become the property of MOTOROLA.

This express limited warranty is extended by MOTOROLA to the original end user purchaser only and is not assignable or transferable to any other party. This is the complete warranty for the Product manufactured by MOTOROLA. MOTOROLA assumes no

obligations or liability for additions or modifications to this warranty unless made in writing and signed by an officer of MOTOROLA.

Unless made in a separate agreement between MOTOROLA and the original end user purchaser, MOTOROLA does not warrant the installation, maintenance or service of the Product.

MOTOROLA cannot be responsible in any way for any ancillary equipment not furnished by MOTOROLA which is attached to or used in connection with the Product, or for operation of the Product with any ancillary equipment, and all such equipment is expressly excluded from this warranty. Because each system which may use the Product is unique, MOTOROLA disclaims liability for range, coverage, or operation of the system as a whole under this warranty.

II. GENERAL PROVISIONS:

This warranty sets forth the full extent of MOTOROLA'S responsibilities regarding the Product. Repair, replacement or refund of the purchase price, at MOTOROLA'S option, is the exclusive remedy. THIS WARRANTY IS GIVEN IN LIEU OF ALL OTHER EXPRESS WARRANTIES. IMPLIED WARRANTIES, INCLUDING WITHOUT LIMITATION, IMPLIED WARRANTIES OF MERCHANTABILITY AND FITNESS FOR A PARTICULAR PURPOSE, ARE LIMITED TO THE DURATION OF THIS LIMITED WARRANTY. IN NO EVENT SHALL MOTOROLA BE LIABLE FOR DAMAGES IN EXCESS OF THE PURCHASE PRICE OF THE PRODUCT, FOR ANY LOSS OF USE, LOSS OF TIME, INCONVENIENCE, COMMERCIAL LOSS, LOST PROFITS OR SAVINGS OR OTHER INCIDENTAL, SPECIAL OR CONSEQUENTIAL DAMAGES ARISING OUT OF THE USE OR

INABILITY TO USE SUCH PRODUCT, TO THE FULL EXTENT SUCH MAY BE DISCLAIMED BY LAW.

III. STATE LAW RIGHTS:

SOME STATES DO NOT ALLOW THE EXCLUSION OR LIMITATION OF INCIDENTAL OR CONSEQUENTIAL DAMAGES OR LIMITATION ON HOW LONG AN IMPLIED WARRANTY LASTS, SO THE ABOVE LIMITATION OR EXCLUSIONS MAY NOT APPLY.

This warranty gives specific legal rights, and there may be other rights which may vary from state to state.

IV. HOW TO GET WARRANTY SERVICE:

You must provide proof of purchase (bearing the date of purchase and Product item serial number) in order to receive warranty service and, also, deliver or send the Product item, transportation and insurance prepaid, to an authorized warranty service location. Warranty service will be provided by MOTOROLA through one of its authorized warranty service locations. If you first contact the company which sold you the Product (e.g., dealer or communication service provider), it can facilitate your obtaining warranty service. You can also call MOTOROLA at 1-800-927-2744 US/Canada.

V. WHAT THIS WARRANTY DOES NOT COVER:

- A) Defects or damage resulting from use of the Product in other than its normal and customary manner.
- B) Defects or damage from misuse, accident, water, or neglect.

- C) Defects or damage from improper testing, operation, maintenance, installation, alteration, modification, or adjustment.
- D) Breakage or damage to antennas unless caused directly by defects in material workmanship.
- E) A Product subjected to unauthorized Product modifications, disassembles or repairs (including, without limitation, the addition to the Product of non-MOTOROLA supplied equipment) which adversely affect performance of the Product or interfere with MOTOROLA's normal warranty inspection and testing of the Product to verify any warranty claim.
- F) Product which has had the serial number removed or made illegible.
- G) Rechargeable batteries if:
 - (1) any of the seals on the battery enclosure of cells are broken or show evidence of tampering.
 - (2) the damage or defect is caused by charging or using the battery in equipment or service other than the Product for which it is specified.
- H) Freight costs to the repair depot.
- I) A Product which, due to illegal or unauthorized alteration of the software/firmware in the Product, does not function in accordance with MOTOROLA's published specifications or the FCC certification labeling in effect for the Product at the time the Product was initially distributed from MOTOROLA.
- J) Scratches or other cosmetic damage to Product surfaces that does not affect the operation of the Product.
- K) Normal and customary wear and tear.

VI. PATENT AND SOFTWARE PROVISIONS:

MOTOROLA will defend, at its own expense, any suit brought against the end user purchaser to the extent that it is based on a claim that the Product or parts infringe a United States patent, and MOTOROLA will pay those costs and damages finally awarded against the end user purchaser in any such suit which are attributable to any such claim, but such defense and payments are conditioned on the following:

- A) that MOTOROLA will be notified promptly in writing by such purchaser of any notice of such claim;
- B) that MOTOROLA will have sole control of the defense of such suit and all negotiations for its settlement or compromise; and
- C) should the Product or parts become, or in MOTOROLA's opinion be likely to become, the subject of a claim of infringement of a United States patent, that such purchaser will permit MOTOROLA, at its option and expense, either to procure for such purchaser the right to continue using the Product or parts or to replace or modify the same so that it becomes non-infringing or to grant such purchaser a credit for the Product or parts as depreciated and accept its return. The depreciation will be an equal amount per year over the lifetime of the Product or parts as established by MOTOROLA.

MOTOROLA will have no liability with respect to any claim of patent infringement which is based upon the combination of the Product or parts furnished hereunder with software, apparatus or devices not furnished by MOTOROLA, nor will MOTOROLA have any liability for the use of ancillary equipment or software not furnished by MOTOROLA which is attached to or used in connection with the Product. The foregoing states the entire liability of MOTOROLA

with respect to infringement of patents by the Product or any parts thereof.

Laws in the United States and other countries preserve for MOTOROLA certain exclusive rights for copyrighted MOTOROLA software such as the exclusive rights to reproduce in copies and distribute copies of such MOTOROLA software. MOTOROLA software may be used in only the Product in which the software was originally embodied and such software in such Product may not be replaced, copied, distributed, modified in any way, or used to produce any derivative thereof. No other use including, without limitation, alteration, modification, reproduction, distribution, or reverse engineering of such MOTOROLA software or exercise of rights in such MOTOROLA software is permitted. No license is granted by implication, estoppel or otherwise under MOTOROLA patent rights or copyrights.

VII. GOVERNING LAW:

This Warranty is governed by the laws of the State of Illinois, U.S.A.

To assure the safety and regulatory compliance of the XPR 6580 IS, the radio must be repaired only at Motorola service facilities. Please call Motorola at 800-422-4210 for the address and contact information of your nearest service center.



Motorola Solutions, Inc.
1303 East Algonquin Road
Schaumburg, Illinois 60196 U.S.A.

MOTOROLA, MOTO, MOTOROLA SOLUTIONS and the Stylized M logo are trademarks or registered trademarks of Motorola Trademark Holdings, LLC and are used under license. All other trademarks are the property of their respective owners.
© 2010, 2012 Motorola Solutions, Inc. All rights reserved.
December 2012.

www.motorolasolutions.com/motrbo



68009410001-C