

MTM800 FuG/MTM800 FuG ET Feature User Guide

Mobile Release 2024.1

JUNE 2024

© 2024 Motorola Solutions, Inc. All Rights Reserved.



68015000585-MT

Contents

List of Figures	12
List of Tables	13
Safety Information	14
Applying for Canadian License	15
Intellectual Property and Regulatory Notices	16
Chapter 1: General Information	17
1.1 Icon Conventions.....	17
1.2 Using this Guide.....	17
1.3 Feature and Service Availability.....	17
Chapter 2: Getting Started	18
2.1 Before Power On.....	18
2.1.1 External TETRA SIM Card Priority.....	18
2.2 Controls and Indicators.....	18
2.3 Powering On the Radio.....	24
2.4 Writing Text.....	24
2.4.1 Text Entry Icons.....	24
2.4.2 Selecting Text Entry Modes.....	25
2.4.3 Selecting Text Entry Methods and Languages.....	25
2.4.4 Keys Usage.....	26
2.4.5 Writing in iTAP Alphanumeric.....	27
2.4.6 Writing in TAP Alphanumeric.....	28
2.4.7 Word Locking.....	28
2.4.8 Adding Words to the Dictionary.....	29
2.5 PIN Code Authentication.....	29
2.5.1 Unblocking Your Radio.....	29
2.6 Locking or Unlocking the Keys or Buttons.....	29
2.7 Display.....	30
2.7.1 Display Orientation.....	30
2.7.2 Configurable Idle Screen.....	31
2.8 Status Icons.....	32
2.9 During a Call.....	36
2.10 Selecting Talkgroups.....	36
2.10.1 Talkgroup Icons Selection.....	37
2.11 Entering TMO or DMO Mode.....	38
2.12 Using Timed Talkgroup Change.....	38

2.13 One-Touch Buttons.....	39
Chapter 3: Modes.....	42
3.1 Trunked Mode Operation.....	42
3.1.1 Entering TMO Mode.....	42
3.1.2 Making Group Calls in TMO.....	42
3.1.3 Receiving Group Calls in Idle.....	43
3.1.4 Receiving Group Calls during Ongoing Group Calls.....	43
3.1.5 D-PTT Preempt Group Call.....	43
3.1.5.1 Preempting Group Calls.....	44
3.1.6 Dynamic Group Number Assignment (DGNA).....	44
3.1.6.1 DGNA Reception.....	44
3.1.6.2 DGNA Auto Select Group.....	44
3.1.6.3 DGNA Auto Reselect Group.....	45
3.1.6.4 Viewing DGNA Talkgroups.....	45
3.1.7 Broadcast Call.....	45
3.1.7.1 Broadcast Calls Initiated by Users.....	45
3.1.7.2 Initializing Broadcast Calls.....	45
3.1.8 Assistance Call.....	46
3.2 Local Site Trunking.....	46
3.2.1 Entering Local Site Trunking.....	46
3.2.2 Exiting Local Site Trunking.....	46
3.3 Direct Mode Operation.....	47
3.3.1 Entering DMO Mode.....	47
3.3.2 Making Group Calls in DMO.....	47
3.3.3 Receiving Group Calls in Idle.....	48
3.3.4 D-PTT Preempt Group Call.....	48
3.3.4.1 Preempting Group Calls.....	48
3.3.5 Selecting DMO Communications Options.....	48
3.3.6 Private Call with Presence Check.....	49
3.3.7 DMO Private Priority Call.....	49
3.3.8 Talkgroup for Individual Calls.....	49
3.3.9 Network Monitor.....	50
3.3.9.1 Enabling Network Monitor.....	50
3.3.10 Communication Through Repeaters.....	50
3.3.11 Communication Through Gateways.....	51
3.3.12 Gateway and Repeater Synchronization.....	52
3.4 Transmit Inhibit Mode.....	52
3.5 Emergency Operations.....	53
3.5.1 Emergency Alarm.....	53

3.5.2 Emergency Group Call.....	54
3.5.2.1 Making Emergency Group Calls.....	54
3.5.2.2 Receiving Emergency Group Calls.....	55
3.5.3 Non-Tactical Emergency.....	55
3.5.4 Emergency Individual Calls (Private or MSISDN).....	55
3.5.5 Emergency SDS Status.....	55
3.5.6 Emergency Hot Microphone.....	55
3.5.7 Alternating Hot Microphone.....	56
3.5.8 Silent Emergency Mode.....	56
3.5.9 Invisible Emergency.....	57
3.5.10 Emergency Alert.....	57
3.5.11 Emergency Mode by Dialing.....	58
3.5.12 Disaster Alert.....	58
3.5.12.1 Initializing Disaster Alert Calls.....	58
3.5.13 Emergency Destination in Local Site Trunking.....	58
3.5.14 Exiting Emergency Operations.....	59
3.6 Repeater Mode.....	59
3.6.1 Setting Monitor Option.....	60
3.6.2 Encryption in the Repeater Mode.....	60
3.7 Gateway Mode.....	60
3.7.1 Entering Gateway Mode.....	61
3.7.2 Standby Mode.....	62
3.7.3 Forwarding Group Calls.....	62
3.7.4 Setting Monitor Options.....	62
3.7.5 Emergency Calls in Gateway Mode.....	62
3.7.6 Encryption in Gateway Mode.....	62
Chapter 4: Main Menu.....	63
4.1 Scrolling through the Menu.....	63
4.2 Menu Icons.....	63
4.3 Messages.....	64
4.3.1 New Message.....	65
4.3.1.1 Sending Messages to Private or Phone.....	65
4.3.1.2 Sending Messages to Groups.....	65
4.3.1.3 Sending Store and Forward Messages.....	65
4.3.1.4 Delivery Report.....	66
4.3.2 Inbox.....	67
4.3.2.1 Receiving New Messages.....	68
4.3.2.2 Opening the Inbox.....	68
4.3.2.3 Using Submenus in Inbox and Outbox.....	69

4.3.2.4	Embedded Number.....	70
4.3.2.5	Storing Numbers from Messages.....	70
4.3.2.6	Calling Numbers from Messages.....	71
4.3.2.7	Making Group Calls on the Talkgroup of the Message Sender.....	71
4.3.2.8	Immediate Text Message.....	71
4.3.3	Outbox.....	72
4.3.4	Call-Out (CO) Box.....	73
4.3.4.1	Call-Out Icons.....	73
4.3.5	Radio Messaging System (RMS) Box.....	73
4.3.6	Wireless Application Protocol (WAP) Box.....	73
4.3.7	Templates.....	73
4.3.7.1	Sending User-Defined Templates.....	74
4.3.7.2	Managing User-Defined Templates.....	74
4.3.8	Predefined Templates.....	75
4.3.8.1	Viewing Predefined Templates.....	75
4.3.8.2	Sending Predefined Templates.....	75
4.3.9	Status Messages.....	75
4.3.9.1	Viewing a Status Message Number.....	76
4.3.9.2	Sending Status Messages.....	76
4.3.9.3	Targeted Status Messages.....	76
4.3.10	Sending an RMS Status.....	77
4.3.11	Additional Address.....	78
4.3.11.1	Enabling or Disabling Additional Address.....	78
4.3.11.2	Selecting Additional Address.....	78
4.3.11.3	Viewing Additional Address.....	78
4.3.11.4	Entering New Additional Address.....	79
4.3.11.5	Editing Additional Address.....	79
4.3.11.6	Deleting Additional Address.....	79
4.3.12	Call-Out Availability.....	80
4.3.12.1	Setting Call-Out Availability.....	80
4.4	Contacts.....	80
4.4.1	Creating Contacts.....	81
4.4.2	Editing Contacts.....	81
4.4.3	Deleting Numbers.....	82
4.4.4	Deleting Contacts.....	82
4.4.5	Checking Capacity.....	82
4.4.6	Dialing Through the Contact List.....	83
4.5	Browser.....	83
4.6	Security.....	83

4.6.1 PIN Protect.....	83
4.6.1.1 Protecting the Radio with a PIN Code.....	83
4.6.1.2 Changing PIN Codes.....	84
4.6.2 Setting Keypad Lock.....	84
4.6.2.1 Keypad Lock Notification.....	84
4.6.2.2 Setting Automatic Keylock Delay.....	85
4.6.2.3 Setting Keylock on Startup.....	85
4.6.3 Air Encryption.....	85
4.6.3.1 Viewing Air Encryption State.....	85
4.6.3.2 Deleting User Keys.....	86
4.6.4 K Validity.....	86
4.6.4.1 Verifying K Validity.....	86
4.6.5 SCK (Air Interface Encryption Class 2).....	86
4.6.5.1 TMO SCK.....	86
4.6.5.2 DMO SCK.....	87
4.6.5.3 Changing DMO SCK.....	87
4.6.6 Covert Mode.....	88
4.6.6.1 Activating Covert Mode.....	88
4.6.7 Remote Control.....	88
4.6.7.1 Status Remote Control.....	89
4.6.7.2 SDS Remote Control.....	89
4.6.7.3 Setting Remote Control.....	89
4.7 Setup.....	90
4.7.1 Ring Style.....	90
4.7.1.1 Setting Ring Style.....	90
4.7.2 Set Volume.....	90
4.7.2.1 Setting Volume.....	90
4.7.3 Language.....	91
4.7.3.1 Setting Language.....	91
4.7.4 Data Setup.....	91
4.7.4.1 Setting Data Function.....	91
4.7.5 Audio.....	92
4.7.5.1 Audio Profiles.....	92
4.7.5.2 Volume Adjustment Mode.....	92
4.7.6 Tones.....	93
4.7.6.1 Keypad Tone.....	93
4.7.6.2 All Tones.....	93
4.7.6.3 Talk Permit.....	94
4.7.6.4 Clear to Send.....	94

4.7.6.5	Periodic Alert.....	94
4.7.6.6	D-PTT Tones.....	95
4.7.7	Display.....	95
4.7.7.1	Setting Font Level.....	95
4.7.7.2	Setting Large Idle Font.....	96
4.7.7.3	Setting Extended Status Icons.....	96
4.7.7.4	Setting Screen Saver.....	96
4.7.7.5	Setting Backlight.....	96
4.7.7.6	Setting Wallpaper.....	97
4.7.8	Time and Date.....	97
4.7.8.1	Setting Time and Date on the Display.....	97
4.7.8.2	Setting the Time Format.....	97
4.7.8.3	Setting the Time Manually.....	98
4.7.8.4	Setting the Date Format.....	98
4.7.8.5	Setting the Date Manually.....	98
4.7.8.6	Setting Time Offset.....	99
4.7.8.7	Setting Automatic Updates for the Time and Date	99
4.7.9	Accessory (Accry) Setup.....	99
4.7.10	Active Accessory (Accry) Type.....	99
4.7.10.1	Selecting the Active Accessory (Accry) Type.....	100
4.7.11	Volume Control (Cntrl).....	100
4.7.11.1	Setting Volume Control (Cntrl).....	100
4.7.12	Accessory (Accry) Setup.....	101
4.7.12.1	Configuring Control Head Accessories.....	101
4.7.12.2	Configuring Transceiver Accessories.....	101
4.7.13	Book On.....	102
4.7.13.1	Editing Book On Settings.....	102
4.7.14	Rotary Knob.....	102
4.7.14.1	Setting Rotary Knob Mode.....	102
4.7.14.2	Setting Rotary Lock.....	103
4.7.14.3	Setting In Keypad Lock.....	103
4.7.14.4	Setting Rotary Knob Wrap Around.....	103
4.7.14.5	Setting Rotary Knob Scroll Range.....	104
4.7.14.6	Setting Rotary Knob Talkgroup Selection.....	104
4.7.15	Default Setting.....	104
4.7.15.1	Selecting Default Setting.....	104
4.8	Group Setup.....	105
4.8.1	Setting Operations Parameters.....	105
4.8.1.1	Standard Home Group.....	105

4.8.2 Scan.....	106
4.8.2.1 Activating Talkgroup Scanning.....	106
4.8.2.2 Setting Talkgroups in the Active Scan List.....	106
4.8.2.3 Setting Scan Lists.....	106
4.8.2.4 Deleting Talkgroups from Scan Lists.....	107
4.8.3 My Groups.....	107
4.8.3.1 Adding Favorite Folders.....	107
4.8.3.2 Adding Talkgroups to Favorite Folders.....	107
4.8.3.3 Deleting Talkgroup from Favorite Folders.....	108
4.9 Individual Setup.....	108
4.9.1 Gateway Mode.....	108
4.9.1.1 Setting Forwarding Address.....	108
4.9.2 Trunked Mode.....	108
4.9.2.1 Enabling or Disabling Call Waiting.....	108
4.9.2.2 Setting Call Forwarding.....	109
4.10 Favorites.....	109
4.10.1 Adding Folders to Favorites.....	109
4.10.2 Adding Contact Numbers to Favorites.....	110
4.10.3 Making Private Calls to Favorite Contacts.....	110
4.10.4 Adding Talkgroups to Favorites.....	110
4.10.5 Managing Folders in Favorites.....	111
4.10.6 Deleting Items from Favorites Folder.....	111
4.10.7 Deleting All Items from Favorite Folders.....	111
4.11 My Info.....	112
4.11.1 Viewing and Modifying Personal Information.....	112
4.11.2 Viewing Talkgroup Subaddresses.....	112
4.12 Recent Calls.....	112
4.12.1 Viewing Recent Calls.....	113
4.12.2 Calling from Recent Calls.....	113
4.12.3 Storing Recent Calls to Contacts.....	113
4.12.4 Deleting Recent Calls.....	114
4.13 Shortcuts.....	114
4.13.1 Creating Menu Shortcuts.....	114
4.13.2 Editing Menu Shortcut Lists.....	115
4.14 Radio User Identity (RUI).....	115
4.14.1 Logging On.....	115
4.14.2 Logging Off.....	116
4.15 Networks.....	116
4.15.1 Selecting Network Operation Mode.....	116

4.15.2 Network Select.....	116
4.15.2.1 Selecting Your Network.....	117
4.15.2.2 Using Select Net Registration.....	117
4.15.2.3 Using Any Network Registration.....	117
4.15.3 Enabling Automatic DMO.....	117
4.15.4 Talkgroup Network Select.....	118
4.15.4.1 Selecting Your Talkgroup Network.....	118
4.15.4.2 Using Select TG Net Registration.....	118
4.15.4.3 Using Prefer TG Net Registration.....	118
4.15.4.4 Using Any TG Net Registration.....	118
4.16 Location.....	119
4.16.1 Enabling GNSS.....	119
4.16.2 Viewing Your Position.....	119
4.16.3 Viewing Testpage.....	119
4.16.4 Backlog.....	120
4.16.4.1 Enabling or Disabling Backlog.....	120
4.16.4.2 Viewing Backlog Reports.....	120
4.16.4.3 Deleting All Backlog Reports.....	120
4.17 Packet Data.....	120
4.17.1 TETRA Enhanced Data Services (TEDS).....	121
4.17.2 Viewing Data Statistics.....	121
4.17.3 Viewing Encryption Status.....	121
4.18 Crypto Menu.....	122
4.18.1 Enabling or Disabling SIM Card End-to-End Encryption.....	122
4.18.2 Setting Clear Call Alarm.....	122
4.18.3 Updating Encryption Keys.....	123
4.18.4 Viewing OPTA.....	123
4.18.5 Setting OPTA Filter.....	123
4.18.6 Starting Crypto Registration.....	123
4.18.7 Configuring Audio Settings.....	124
4.18.8 Setting DMO Encryption Mode.....	124
4.18.9 Setting Encryption Keys for SDS Messages.....	124
Chapter 5: Features.....	125
5.1 Ambience Listening (AL) Call.....	125
5.2 Buffer Full Overwrite Policy.....	125
5.3 Call-Out.....	125
5.3.1 Types of Call-Out Alerts.....	126
5.3.2 Call-Out Modes Interaction.....	127
5.3.3 Call-Out Service Phases.....	127

5.4 DTMF Overdial.....	128
5.5 Dual Control Head.....	128
5.5.1 Interactions Between Control Heads.....	128
5.5.2 Dual Control Head Link.....	129
5.5.3 Audio Accessories.....	129
5.5.4 Transmission Monitor.....	130
5.5.5 Keys Interactions.....	130
5.6 GNSS Location Service.....	130
5.6.1 Enhance GNSS Performance.....	131
5.6.2 Location Report Backlog.....	131
5.6.3 GNSS Icon.....	132
5.6.4 Different Location Displays.....	132
5.6.5 GNSS Accuracy.....	133
5.7 Home Mode Display Text Message.....	133
5.8 Horn and Lights Alarm.....	133
5.9 Individual Call.....	133
5.9.1 Private Call.....	133
5.9.1.1 Making Private Calls.....	134
5.9.2 Phone and PABX Calls.....	134
5.9.2.1 Making Phone or PABX Calls.....	135
5.9.2.2 Using the Phone/PABX Speed Dial.....	135
5.9.3 Receiving Individual Calls.....	135
5.10 MS-ISDN.....	136
5.11 Multi Radio Control.....	136
5.11.1 Selecting Radios.....	136
5.12 OEM Control Head.....	137
5.13 One-Touch Dial.....	137
5.14 Radio Messaging System (RMS).....	137
5.14.1 Radio Messaging System Icons.....	138
5.15 Radio User Assignment (RUA) and Radio User Identity (RUI).....	138
5.16 Shadow Groups (Address Bundle).....	139
5.17 SIM Card End-to-End Encryption.....	139
5.18 Short Number Dial.....	140
5.19 Talkgroup Dialing by Index.....	140
5.19.1 Viewing the Talkgroup Speed Number.....	140
5.19.2 Selecting Talkgroups by Index.....	141
5.20 Terminal Permanent Disable.....	141
5.21 Temporary Disable or Enable.....	141
5.22 Wireless Application Protocol (WAP).....	141

5.22.1 WAP Browser.....	141
5.22.2 Entering the Browser.....	142
5.22.3 Entering Browser Menu Panes.....	142
5.22.4 Tips for Browsing.....	142
5.22.4.1 Creating Bookmarks through the Navigate Pane.....	142
5.22.4.2 Creating Bookmarks through the Bookmarks Pane.....	143
5.22.4.3 Using Bookmarks.....	143
5.22.4.4 Creating Hotkeys.....	143
5.22.4.5 Using Hotkeys.....	143
5.22.4.6 Saving Pages.....	144
5.22.4.7 Selecting Saved Pages.....	144
5.22.5 Disabled Packet Data Service.....	144
5.22.6 Disabled Browser Entry.....	144
5.22.7 Browser Keys Usage.....	145
5.22.8 Browser Menu Panes Overview.....	146
5.22.9 Navigate Pane.....	146
5.22.10 Advanced.....	147
5.22.11 Bookmarks Pane.....	147
5.22.11.1 Working with the Options Pane for Selected Bookmarks.....	147
5.22.11.2 Working with the Saved Pages Folder.....	148
5.22.12 History Pane.....	148
5.22.12.1 Navigating to Recently Visited URLs.....	148
5.22.13 Tools Pane.....	149
5.22.14 Options Pane.....	149
5.22.15 Text Input Pane.....	149
5.22.16 WAP Push.....	150
5.22.16.1 New WAP Messages.....	150
5.22.16.2 Viewing WAP Messages.....	150
Appendix A: LED Indications.....	151
Appendix B: Troubleshooting.....	152
Appendix C: Audio Routing and PTT Hook Interactions.....	155

List of Figures

Figure 1: Default Home Screen with Icons.....	30
Figure 2: Trunked Mode Operation.....	42
Figure 3: Direct Mode Operation.....	47
Figure 4: Communication Through Repeaters.....	51
Figure 5: Communication Through Gateways.....	51
Figure 6: Repeater Mode Operation.....	59
Figure 7: Gateway Mode Operation.....	61
Figure 8: Call-Out Message.....	126

List of Tables

Table 1: Special Notations.....	17
Table 2: Controls and Indicators – New Generation Control Head (NGCH) / Remote Ethernet Control Head (RECH).....	19
Table 3: Controls and Indicators – Telephone Style Control Head (TSCH).....	22
Table 4: Controls and Indicators – Cradle.....	24
Table 5: Text Entry Icons.....	25
Table 6: Keys Usage.....	26
Table 7: Other Keys.....	26
Table 8: Display.....	30
Table 9: Colors of the Soft Key Area.....	30
Table 10: Status Icons.....	32
Table 11: During the Call.....	36
Table 12: Talkgroup Icons.....	37
Table 13: One-Touch Button Features.....	39
Table 14: Emergency Operation Dependencies.....	57
Table 15: Menu Icons.....	63
Table 16: Description of Delivery Report Notification.....	66
Table 17: Inbox Icons.....	67
Table 18: Outbox Icons.....	72
Table 19: Call-Out Icons.....	73
Table 20: Contact Types.....	80
Table 21: Different Location Displays.....	132
Table 22: RMS Icons.....	138
Table 23: Interactions between Radios with and without SIM Cards.....	139
Table 24: Browser Keys Interactions.....	145
Table 25: Browser Menu Panes.....	146
Table 26: Additional Menu Panes.....	146
Table 27: Browser Text Input Icons.....	149
Table 28: LED Status Indications.....	151
Table 29: Displayed Messages.....	152
Table 30: Available audio route types.....	155
Table 31: Audio Routing Schemes.....	156
Table 32: PTT and Hook Interactions for Group Calls.....	159

Safety Information

RF Energy Exposure and Product Safety Guide for Mobile Two-Way Radios

ATTENTION!

This radio is restricted to Occupational use only. Before using your radio, read the RF Energy Exposure and Product Safety Guide for Mobile Two-Way Radios that contains important operating instructions for safe usage and RF energy awareness and control for Compliance with applicable standards and Regulations.

For a list of Motorola Solutions-approved antennas and other accessories, visit the following website:

<https://www.motorolasolutions.com>

Under Innovation, Science, and Economic Development Canada (ISED) regulations, this radio transmitter may only operate using an antenna of a type and maximum (or lesser) gain approved for the transmitter by ISED. To reduce potential radio interference to other users, the antenna type and its gain should be so chosen that the equivalent isotropically radiated power (e.i.r.p.) is not more than that necessary for successful communication.

This radio transmitter has been approved by ISED to operate with Motorola Solutions-approved antenna with the maximum permissible gain and required antenna impedance for each antenna type indicated. Antenna types not included in this list, having a gain greater than the maximum gain indicated for that type, are strictly prohibited for use with this device.

Applying for Canadian License

The operation of your Motorola Solutions radio is subject to the Radio communications Act and must comply with rules and regulations of the Federal Government's department of Innovation, Science, and Economic Development Canada (ISED). ISED requires that all operators using Private Land Mobile frequencies obtain a radio license before operating their equipment.

Prerequisites: Obtain the latest Canadian License Application form at http://www.ic.gc.ca/ic_wp-pa.htm.

Procedure:

1. Fill in the items as per the instructions. Be sure to print legibly.
If you need additional space for any item, use the reverse side of the application.
2. Make a copy of your files.
3. Prepare a cheque or money order payable to the "Receiver General for Canada", for an amount for each radio purchased.
The license is renewed on April 1st each year, and issued for a period of 12 months.
4. Mail your completed application along with your cheque or money order to the closest ISED office.

Intellectual Property and Regulatory Notices

Copyrights

The Motorola Solutions products described in this document may include copyrighted Motorola Solutions computer programs. Laws in the United States and other countries preserve for Motorola Solutions certain exclusive rights for copyrighted computer programs. Accordingly, any copyrighted Motorola Solutions computer programs contained in the Motorola Solutions products described in this document may not be copied or reproduced in any manner without the express written permission of Motorola Solutions.

No part of this document may be reproduced, transmitted, stored in a retrieval system, or translated into any language or computer language, in any form or by any means, without the prior written permission of Motorola Solutions, Inc.

Trademarks

MOTOROLA, MOTO, MOTOROLA SOLUTIONS, and the Stylized M Logo are trademarks or registered trademarks of Motorola Trademark Holdings, LLC and are used under license. All other trademarks are the property of their respective owners.

License Rights

The purchase of Motorola Solutions products shall not be deemed to grant either directly or by implication, estoppel or otherwise, any license under the copyrights, patents or patent applications of Motorola Solutions, except for the normal nonexclusive, royalty-free license to use that arises by operation of law in the sale of a product.

Open Source Content

This product may contain Open Source software used under license. Refer to the product installation media for full Open Source Legal Notices and Attribution content.

European Union (EU) and United Kingdom (UK) Waste of Electrical and Electronic Equipment (WEEE) Directive



The European Union's WEEE directive and the UK's WEEE regulation require that products sold into EU countries and the UK must have the crossed-out wheellie bin label on the product (or the package in some cases). As defined by the WEEE directive, this crossed-out wheellie bin label means that customers and end users in EU and UK countries should not dispose of electronic and electrical equipment or accessories in household waste.

Customers or end users in EU and UK countries should contact their local equipment supplier representative or service center for information about the waste collection system in their country.

Disclaimer

Please note that certain features, facilities, and capabilities described in this document may not be applicable to or licensed for use on a specific system, or may be dependent upon the characteristics of a specific mobile subscriber unit or configuration of certain parameters. Please refer to your Motorola Solutions contact for further information.

© 2024 Motorola Solutions, Inc. All Rights Reserved

Chapter 1

General Information

1.1

Icon Conventions

The documentation set is designed to give the reader more visual clues. The following graphic icons are used throughout the documentation set.



DANGER: The signal word DANGER with the associated safety icon implies information that, if disregarded, will result in death or serious injury.



WARNING: The signal word WARNING with the associated safety icon implies information that, if disregarded, could result in death or serious injury, or serious product damage.



CAUTION: The signal word CAUTION with the associated safety icon implies information that, if disregarded, may result in minor or moderate injury, or serious product damage.

CAUTION: The signal word CAUTION may be used without the safety icon to state potential damage or injury that is not related to the product.



IMPORTANT: IMPORTANT statements contain information that is crucial to the discussion at hand, but is not a CAUTION or WARNING. There is no warning level associated with the IMPORTANT statement.



NOTE: NOTICE contains information more important than the surrounding text, such as exceptions or preconditions. They also refer the reader elsewhere for additional information, remind the reader how to complete an action (when it is not part of the current procedure, for instance), or tell the reader where something is on the screen. There is no warning level associated with a notice.

1.2

Using this Guide

The following special notations are used throughout the text to highlight certain information or items:

Table 1: Special Notations

Example	Description
Menu key or PTT button	Bold words indicate a name of a key, button, or soft menu item.
<i>Entering TMO</i> tone	Italic words indicate a name of the tone.
Powering Off	Typewriter words indicate the MMI strings or messages displayed on the radio.
Setup → Tones → All Tones	Bold words with the arrow between indicate navigation structure in the menu items.

1.3

Feature and Service Availability

This guide describes all available radio features and services. Your service provider may have customized your radio to optimize its use for your individual needs. Check with your service provider to find out the differences from this guide.

Chapter 2

Getting Started

Familiarize yourself with basic information on how to use your radio.

2.1

Before Power On

Read this section before you power on your radio for the first time.

2.1.1

External TETRA SIM Card Priority

When you insert a TETRA SIM card into the external TETRA SIM reader, it gets prioritize over the internal TETRA SIM card. The internal TETRA SIM card remains deactivated as long as an external TETRA SIM card is plugged in.

2.2

Controls and Indicators

The MTM800 FuG/MTM800 FuG ET radio specifications are available at <https://www.motorolasolutions.com/mtm5000>.

New Generation Control Head (NGCH) / Remote Ethernet Control Head (RECH)

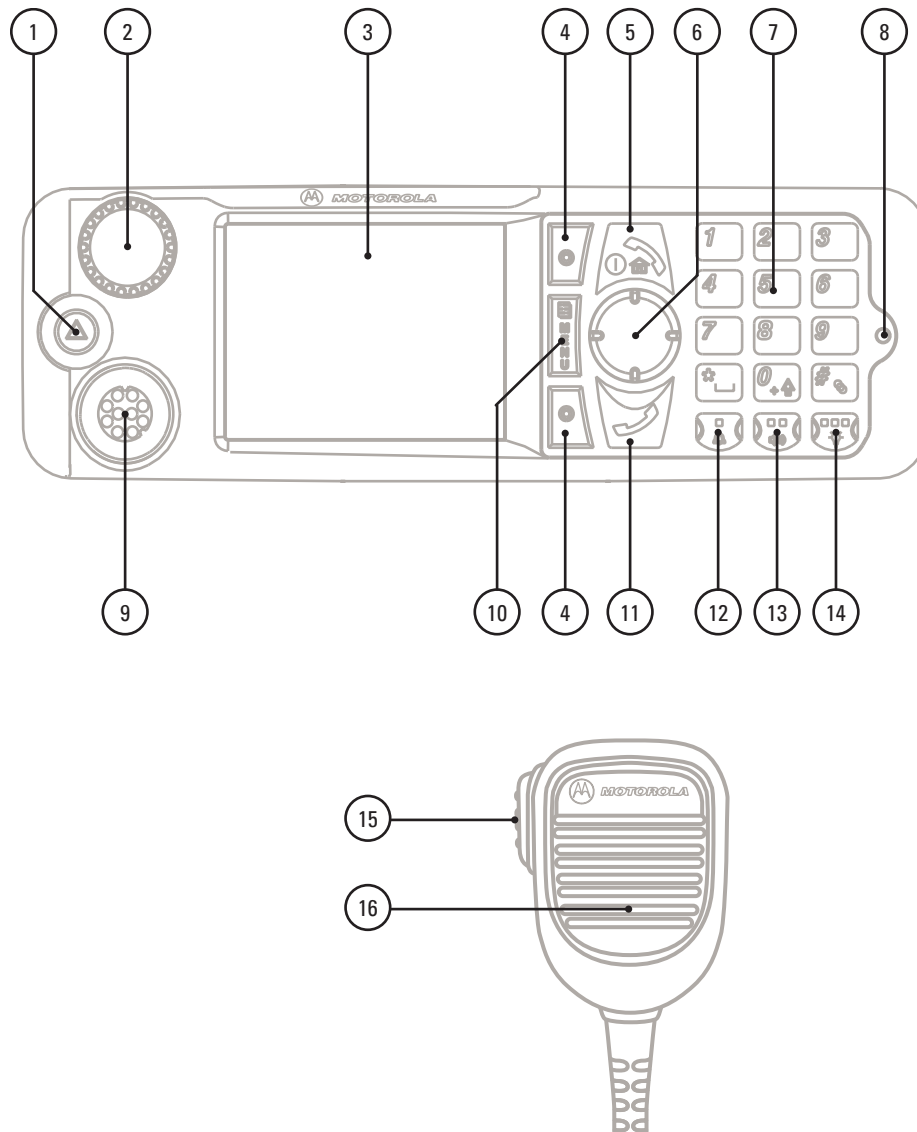



Table 2: Controls and Indicators – New Generation Control Head (NGCH) / Remote Ethernet Control Head (RECH)

Annotation	Description
1	<p>Emergency button</p> <p>Press and hold Emergency button to enter Emergency operation. By default, when your radio is off, press and hold to Power On in Emergency Mode.</p>
2	<p>Rotary Knob</p> <ul style="list-style-type: none"> ● Press and hold to turn on your radio. ● Rotate to set the volume. ● Press and rotate to select a different talkgroup. ● Press and hold the Rotary Knob to lock/unlock it. Powering off also unlocks a locked Rotary Knob.

Annotation	Description
3	<p>Display</p> <p>Provides alphanumeric text and images within 65,536 colors and 640 x 480 pixels with backlighting and scalable fonts.</p> <p> NOTE: Before using your radio for the first time, remove the plastic lens protector from the display.</p>
4	<p>Soft key</p> <p>Press Upper or Lower Soft key, to select the option that appears on the screen next to it.</p>
5	<p>On/Off/End/Home Key</p> <ul style="list-style-type: none">● Press and hold to turn on/off your radio.● Press to end calls.● Press to return to the home screen.
6	<p>Navigation key</p> <p>Press Up, Down, Left, or Right Navigation key for list scrolling, while moving around the menu hierarchy, or for alphanumeric text editing.</p> <p>From the home screen, press to activate one of the following:</p> <ul style="list-style-type: none">● Down Navigation key – enters Recent Calls menu item.● Up Navigation key – changes My Groups talkgroup folder.● Left and Right Navigation key – toggles through the talkgroups.
7	<p>Alphanumeric Keypad</p> <p>Use the keypad to enter alphanumeric characters for dialing, contact entries, and text messages.</p>
8	<p>LED Status Indicator</p>
9	<p>Mobile Microphone Port</p> <p>Provides connection for accessories such as a fist microphone with PTT.</p>
10	<p>Menu key</p> <p>Press to enter the main menu and the context-sensitive menu.</p>
11	<p>Send key</p> <ul style="list-style-type: none">● Press to initiate or answer duplex calls, or send messages.● Press in home screen to enter Recent Dialed Calls.
12	<p>FUNCTION key 1</p> <p>By default:</p> <ul style="list-style-type: none">● Short press – activates/deactivates the horn and lights feature.● Long press – adjusts the backlight.
13	<p>FUNCTION key 2</p> <p>By default:</p> <ul style="list-style-type: none">● Short press – turns the speaker on/off.● Long press – activates/deactivates the screen saver.
14	<p>FUNCTION key 3</p>

Annotation	Description
	<ul style="list-style-type: none"> • Short press – adjusts the backlight. • Long press – unassigned.
15	Push-To-Talk (PTT) Press and hold to talk in simplex calls or to initiate a group call, release it to listen.
16	Microphone

 **NOTE:** While pressing the expansion PTT (on the expansion head), other PTT press on an accessory connected to the control head is ignored. This condition only applies to MTM800 FuG.

Telephone Style Control Head (TSCH)

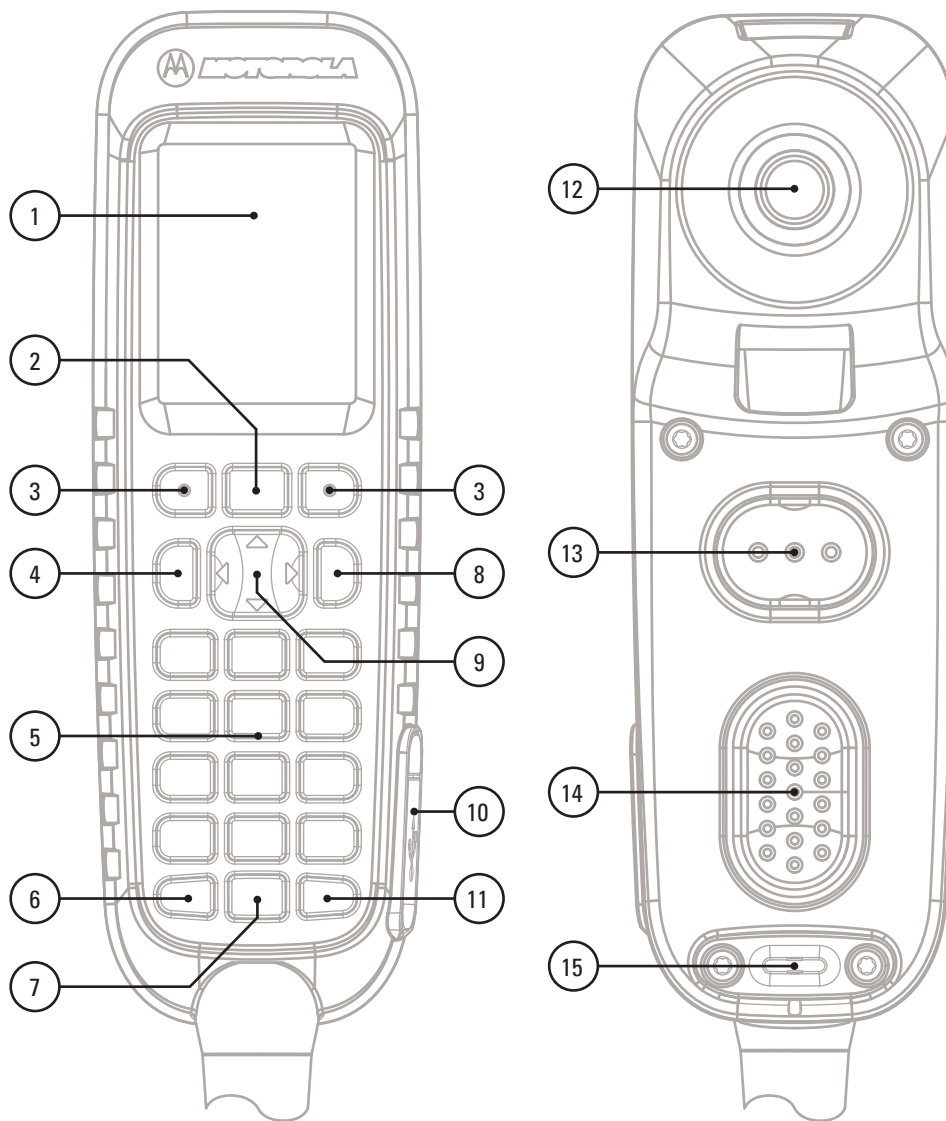



Table 3: Controls and Indicators – Telephone Style Control Head (TSCH)

Annotation	Description
1	<p>Display Provides alphanumeric text and images within 65,536 colors and 240 x 320 pixels with backlighting and scalable fonts.</p> <p> NOTE: Before using your radio for the first time, remove the plastic lens protector from the display.</p>
2	<p>Menu key Press to enter the main menu and the context-sensitive menu.</p>
3	<p>Soft keys Press Left or Right Soft key, to select the option that appears on the screen above it.</p>
4	<p>Send key</p> <ul style="list-style-type: none">• Press to initiate or answer duplex calls, or send messages.• Press in home screen to enter Recent Dialed Calls.
5	<p>Alphanumeric Keypad Use the keypad to enter alphanumeric characters for dialing, contact entries, and text messages.</p>
6	<p>FUNCTION key 1 By default:</p> <ul style="list-style-type: none">• Short press – activates/deactivates the horn and lights feature.• Long press – adjusts the backlight.
7	<p>FUNCTION key 2 By default:</p> <ul style="list-style-type: none">• Short press – turns the speaker on/off.• Long press – activates/deactivates the screen saver.
8	<p>On/Off/End/Home Key</p> <ul style="list-style-type: none">• Press and hold to turn on/off your radio.• Press to end calls.• Press to return to the home screen.
9	<p>Navigation key Press Up, Down, Left, or Right Navigation key for list scrolling, while moving around the menu hierarchy, or for alphanumeric text editing.</p> <p>From the home screen, press to activate one of the following:</p> <ul style="list-style-type: none">• Down Navigation key – enters Recent Calls menu item.• Up Navigation key – changes My Groups talkgroup folder.• Left and Right Navigation key – toggles through the talkgroups.
10	<p>Micro USB Port Provides connection between the radio and a computer.</p>
11	<p>FUNCTION key 3</p>

Annotation	Description
	<ul style="list-style-type: none">• Short press – adjusts the backlight.• Long press – unassigned.
12	Earpiece
13	Upper Push-To-Talk (PTT) button By default, this PTT button is disabled. However, your service provider can assign one of the following functions to it: <ul style="list-style-type: none">• Upper PTT button works in the same way as the lower PTT button (you can use both interchangeably).• Upper PTT supports a roof speaker. Roof speaker allows sound to be transferred through an external speaker connected to the transceiver.
14	Lower Push-To-Talk (PTT) button Press and hold to talk in simplex calls or to initiate a group call, release it to listen.
15	Microphone

Cradle

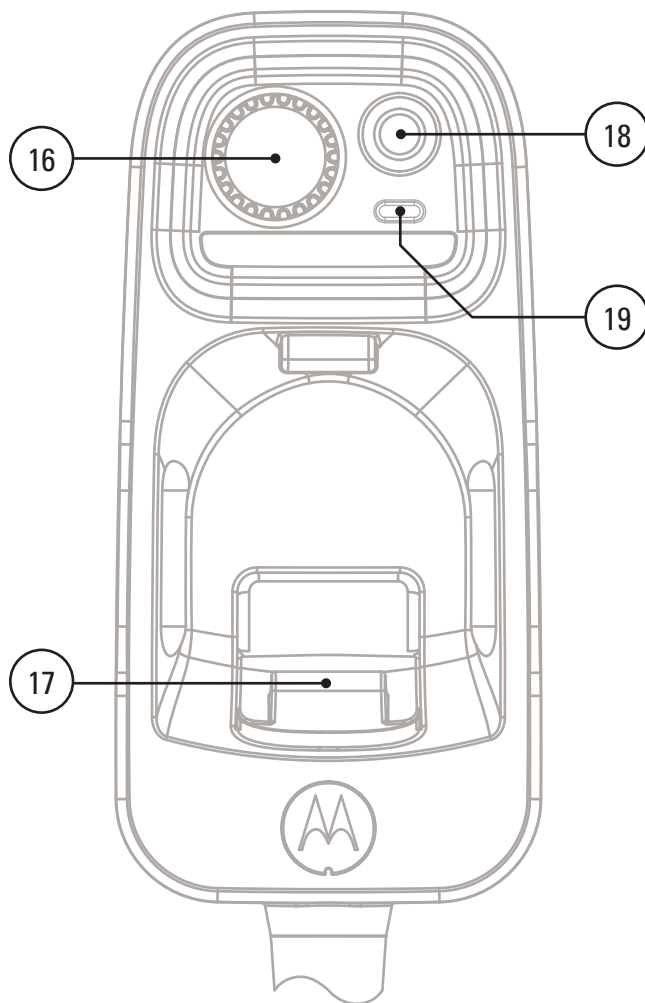

Table 4: Controls and Indicators – Cradle

Annotation	Description
16	Rotary Knob <ul style="list-style-type: none">• Press and hold to turn on your radio.• Rotate to set the volume.• Press and rotate to select a different talkgroup.• Press and hold the Rotary Knob to lock/unlock it. Powering off also unlocks a locked Rotary Knob.• Press to make the Rotary Knob operate like left/right navigation keys.
17	Hook
18	Emergency button Press and hold Emergency button to enter Emergency operation. By default, when your radio is off, press and hold to Power On in Emergency Mode.
19	LED Status Indicator



NOTE:

- It is recommended to turn off the terminal before connecting any of the accessories.
- A detailed list of compatible accessories is included in Accessory Leaflet, part number: 68015000182. To obtain the document, contact your service provider.

2.3

Powering On the Radio

Procedure:

Press and hold the **On** button until the screen turns on.



IMPORTANT: Do not press any key until the radio is powered up.

Result: Your radio performs a self-check and registration routine. After successful registration, your radio is in service.



NOTE: Your radio powers on without visible and audible notification if Covert Mode is activated.

2.4

Writing Text

This section provides information on entering texts on your radio.













2.4.1

Text Entry Icons

In the text entry screen, icons tell you which text entry mode and method you are using. A character counter displayed on the text entry icon indicates the amount of characters that can be entered.

Press the **#** key to toggle through the text entry modes.

Table 5: Text Entry Icons

Primary Icon	Secondary Icons	Description
		TAP – no capitals
		TAP – capitalize first letter only
		TAP – all capitals
		iTAP – no capitals
		iTap – capitalize first letter only
		iTap – all capitals

2.4.2

Selecting Text Entry Modes

Prerequisites: Your radio displays the text entry screen.

Procedure:

1. Press **Menu** → **Entry Mode**.
2. Select one of the following options:
 - **Primary** – for entering alphanumeric characters.
 - **Numeric** – for entering numbers only.
 - **Symbol** – for entering symbols only.
 - **Secondary** – for entering alphanumeric characters (this mode is optional and you have to add it to the list). It is convenient when you use one language, and sometimes wish to switch to another one.

 **NOTE:** In the text entry screen, you can also press **#** key repeatedly to toggle through the entry modes.

2.4.3

Selecting Text Entry Methods and Languages

Prerequisites: Your radio displays the text entry screen.

Procedure:

1. Press **Menu** → **Entry Setup**.
2. Use the **Right** or **Left** navigation key to select one of the following options:
 - **TAP** – Enter letters, numbers, and symbols by pressing an alphanumeric key one or more times.
 - **iTAP** – Allows the radio to predict each word as you press an alphanumeric key.

 **NOTE:** You can use these methods in the languages programmed in the radio.

2.4.4 Keys Usage

List of keys and characters in Alphanumeric Mode (TAP/iTAP).

Table 6: Keys Usage

Key	Alphanumeric Mode (TAP/iTAP)	Symbol Mode
0 to 9 keys	Numeric Mode: <ul style="list-style-type: none"> Press to enter digit at insertion point. Press and hold any numeric key to enter TAP alphanumeric mode. To exit TAP alphanumeric mode, press and hold any numeric key. 	
0 key	Press to cycle through single shift, caps lock, and lower case.	+ - * / \ [] = < > § #
1 key	. , ? ! 0 1 @ ' " - () / : _ ; + & % × * = < > € £ \$ ¥ ¢ [] { } \ ~ ^ ¿ ¡ § #	
2 key	A B C 2 a b c 2	@ _ \
3 key	D E F 3 d e f 3	/ , ;
4 key	G H I 4 g h i 4	" & '
5 key	J K L 5 j k l 5	() [] {}
6 key	M N O 6 m n o 6	¿ ¡ ~
7 key	P Q R S 7 p q r s 7	= < >
8 key	T U V 8 t u v 8	€ £ \$ ¥ ¢
9 key	W X Y Z 9 w x y z 9	# % *

Table 7: Other Keys

Key	Description
Any numeric key	<ul style="list-style-type: none"> In TAP press any key to reject word completion and continue with text entry. A new completion will be displayed, if available, after the time-out for TAP expires. Press and hold to enter Numeric mode from TAP or iTAP alphanumeric.

Key	Description
* key	<ul style="list-style-type: none"> • Press to insert a space. • In TAP press to dismiss a word completion and insert a space. • Enter a newly created word into the user dictionary. • Press and hold to enter a carriage return.
# key	<ul style="list-style-type: none"> • Press once to cycle through all entry modes (Symbol, Numeric, Primary, and Secondary (if configured)). • Press and hold to return to the default entry mode.
Select	Press to select the highlighted choice and place it in the main text area.
Delete	<ul style="list-style-type: none"> • Press once to delete the last entered character. • Press and hold to clear the entire main text area.
Up Navigation key	<ul style="list-style-type: none"> • In TAP press to reject word completion and scroll up. • In TAP press to change previously entered small letter to capital.
Down Navigation key	<ul style="list-style-type: none"> • In TAP press to reject word completion and scroll within the text area. • In TAP press to change previously entered capital letter to small.
Left Navigation key	<ul style="list-style-type: none"> • Press to navigate to the left. Press and hold to repeat. • In TAP, if a word completion is available, press to reject the completion.
Right Navigation key	<ul style="list-style-type: none"> • Press to navigate to the right. Press and hold to repeat. • In TAP if a word completion is available, press to accept the word.
Menu	If a context-sensitive menu is active, opens the Context Sensitive Menu.

2.4.5

Writing in iTAP Alphanumeric

Prerequisites: Your radio displays the text entry screen.

When and where to use: It allows you to write quicker. For example, try to write **David 232!**

Procedure:

1. Press **Menu** → **Entry Setup** → **Prim..**
2. Select **iTAPEnglish** and press **Back**.
3. Press **Menu** → **Entry Mode**.
4. Select **Primary**.
5. Press **3** key.

The alternative row opens and shows **D E F 3**.

6. Continue entering the letters by pressing one key for each letter. Press **2**, **8**, **4**, and **3** keys.



NOTE: Automatic shift to upper case is used at the beginning of a message, after punctuation followed by space, or for the first letter of a word created as a new contact entry.

The alternative row highlights **David**.

7. Press ***** key.
8. Press **2** key and scroll the alternative row by pressing **Right** Navigation key to reach **2**.
It automatically changes the entry mode to **Numeric**.
9. Press **3** and **2** keys.
10. Press and hold **1** key until **0** at the end changes to **.**.
The alternative row highlights **232**.
11. Scroll the alternative row by pressing the **Right** Navigation key to reach the required symbol.
12. Press **Select**.

Result: You have entered **David 232!**.

2.4.6

Writing in TAP Alphanumeric

Prerequisites: Your radio displays the text entry screen.

Procedure:

1. Press **Menu** → **Entry Setup** → **Seco**.
2. Select **TAPEnglish** and press **Back**.
3. Press **Menu** → **Entry Mode**.
4. Select **Secondary**.
5. Press the key labeled with the desired character, once for the first character, twice for the second, and so on.

Example:

To enter letter s, press **7** key four times. To enter number 7, press the **7** key five times. If you do not press a key for a few seconds, the character is accepted, and the cursor moves to the next position.

2.4.7

Word Locking

Prerequisites: Your radio displays the text entry screen.

When and where to use: To add the words that are not in the dictionary.

Procedure:

1. Press **Menu** → **Entry Setup** → **Prim**.
2. Select **iTAPEnglish** and press **Back**.
3. Enter the word. Scroll the alternate line for a word option. Each option is successively highlighted and partially locked.
4. Enter the second part of the word. The first part remains unchanged (locked). The newly entered letters are highlighted and then locked while you scroll to the next word option.
5. Press the ***** key. The word is placed in the text area with a space and automatically added to the dictionary.

2.4.8

Adding Words to the Dictionary

Each language comes with its own dictionary. You can create words (including alphanumeric abbreviations). Once you enter a word followed by space, it is automatically stored in the dictionary and appears as a choice whenever you press the same key combination in the future.

2.5

PIN Code Authentication

If pre-set by your service provider, your radio has active PIN Code Authentication, which helps you increase security and protect your radio against unauthorized use.

The BSI PIN code is read from the TETRA SIM card and cannot be changed or disabled. However, the general PIN code read from the codeplug configuration can be changed and disabled using radio HMI or codeplug. If you are unable to unlock your radio, you cannot send or receive any call, nor adjust the volume level with the **Rotary Knob**.

You are asked to enter the PIN code each time you turn on your radio.



NOTE:

If your radio is using BSI PIN authentication, the radio disables the general PIN authentication.

2.5.1

Unlocking Your Radio

If you have entered the incorrect PIN code for more than three times (by default), use the PIN Unlocking Key (PUK) to unlock your radio.

Prerequisites: Radio displays `Unit Blocked Enter PUK`.

Procedure:

1. Enter the PUK code at the prompt.



NOTE: The PUK is a primary code provided by your service provider. For radios with general PUK authentication, the PUK length is a fixed 8-digit code. For radios with BSI PUK authentication, the PUK length is configurable by your service provider up to a maximum of 8-digit code.

When PUK code is successfully entered, radio displays the PIN code prompt.

2. Enter the PIN code at the prompt.



NOTE: If change PIN option is enabled by your service provider, you are able to change your PIN code. Enter your new PIN code twice to change the PIN code.

2.6

Locking or Unlocking the Keys or Buttons

Procedure:

Press **Menu** key and * key.



NOTE: The **Emergency** button is not locked. Entering Emergency Mode unlocks all keys.

2.7 Display

This section presents the default home screen elements of the radio.

Figure 1: Default Home Screen with Icons

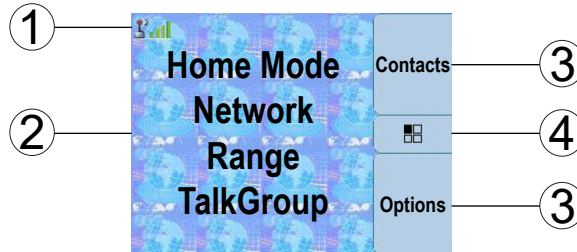

Table 8: Display

Annotation	Description
1	Status icon area
2	Text display area
3	Soft key area
4	Menu/Context sensitive icon

The color of the Soft key area changes according to the mode the radio is in.

Table 9: Colors of the Soft Key Area

Color	Mode or State
Light blue	Normal TMO and DMO Modes
Light red	Emergency Mode or Disaster Alert Call
Olive	Local Site Trunking Mode
Yellow	Call Out – Standby
Red	Call Out – Alert
Green	Call Out – Accepted
Blue	Radio Messaging Service (RMS)
Gray	Radio User Assignment (RUA) – Limited service

2.7.1 Display Orientation

The display on the Telephone Style Control Head (TSCH) can rotate, which increases readability and facilitates operation. When a single TSCH, or a combination of TSCH and Remote Ethernet Control Head (RECH) (IP54 or IP67 RECH) is used, the following display orientation is possible:

- When the TSCH is off-hook, the display orientation is portrait.
- When the TSCH is on-hook, the display orientation can take one of the following positions (depending on your service provider configuration):

- Fixed portrait
- Clockwise
- Counterclockwise

2.7.2

Configurable Idle Screen

Your service provider can configure the information that is displayed on the idle screen below the status icon area. The displayed information depends on your radio configuration and services supported.

- Audio Profile Name
- BSI Registration Status
- Radios with the Gateway feature enabled :
 - Gateway Background Mode (with one of the reasons for entering the mode):
 - Configuration
 - TMO Failure
 - Gateway Detected
 - Repeater Call
 - DMO Call
 - Unknown
 - Gateway TMO Zone
 - Gateway TMO Talkgroup
 - Gateway DMO Zone
 - Gateway DMO Talkgroup
- Home Mode
- Individual Short Subscriber Identity (ISSI)
- International Talkgroup Link Alias
- Network (No Service, or Mobile Country Code (MCC)/Mobile Network Code (MNC), or Networks Alias)
- Operational-Tactical Address (OPTA)
- Radio Status
- Range
- RMS/FMS
- Scan List Alias
- Secondary Talkgroup Alias
- Talkgroup Alias
- Time and Date













Order and visibility of these items are also subject of the Configurable Idle Screen settings.















2.8















Status Icons



















Status icons appear when your radio is engaged in certain activities or when you have activated certain features.





Table 10: Status Icons

Icon	Description
Trunked Mode Operation (TMO)	
	In Service
	No Service
	Signal Strength – The more bars, the stronger the signal.
	Migration – Indicates that the radio is registered to a foreign network.
	Broadcast Call – Indicates that the radio is in a Broadcast Call.
	Gateway Mode – Indicates that the radio is operating as a gateway in Gateway Mode.
	Scan – Indicates that talkgroup scanning is activated in the radio.
	Packet Data or Multi-Slot Packet Data (MSPD) / TETRA Enhanced Data Services (TEDS) – The more blue sections on the icon, the faster the data transfer. Possible status: <ul style="list-style-type: none"> • Four gray sections: context activated – data idle • One blue: Packet Data active • Two blue: Multi-Slot Packet Data active • Three blue: TEDS 25 kHz active • Four blue: TEDS 50 kHz active
Direct Mode Operation (DMO)	
	Direct Mode Call – Indicates that the radio is receiving a Direct Mode call. The more bars, the stronger the signal.
	Direct Mode – Indicates that radio is in Direct Mode (radio-to-radio communication).
	Repeater Mode – Indicates that radio is operating as a repeater in Repeater Mode. The icon blinks when the radio is in Repeater Background Mode.
	DMO Gateway Communication Mode – Indicates that gateway is selected. The icon has the following status: <ul style="list-style-type: none"> • Solid – when the radio is synchronized with the gateway. • Blinking – when the radio is not synchronized or during attachment. • No icon – during radio-to-radio and repeater communication.

Icon	Description
	DMO Repeater Communication Mode – Indicates that the Repeater or GW + Rep option in DMO Mode is selected. The icon has the following status: <ul style="list-style-type: none"> • Solid – when the radio has detected the repeater (for example, when the radio receives a presence signal). • Blinking – when the radio has not detected the repeater or during attachment. • No icon – during a radio-to-radio and gateway communication.
	Automatic DMO Mode - Indicates that Automatic DMO is enabled.
	Automatic DMO Mode - Indicates that Automatic DMO is disabled.
General Icons	
	All Tones Off – Indicates that: <ul style="list-style-type: none"> • Volume is set to 0 (when Volume Adj. Mode is set to Common). • Both simplex and duplex ring volume is set to 0 (when Volume Adj. Mode is set to Individual).
	Simplex Ring Muted – Indicates that simplex ring volume is set to 0 and duplex ring volume is set to more than 0.
	Duplex Ring Muted – Indicates that duplex ring volume is set to 0 and simplex ring volume is set to more than 0.
	Speaker Off – Indicates that audio will not sound through the speaker.
	Audio Profile Selected – Indicates that an audio profile associated with a particular icon is active. For details on audio profiles available on the radio, contact your service provider.
	Horn and Lights – Indicates that an external alarm, for example, horn and lights is activated.
	GNSS <ul style="list-style-type: none"> • Solid – the radio has a location fix. • Blinking – the radio is acquiring a location fix. This feature is an optional setting and may not be enabled on your radio.
	RUI Logged on – Indicates that you are logged on into the radio.
	RUI Pseudo Log On – Indicates that you are in pseudo logged on state.
	RUI Packet Data – Indicates Pseudo Log On state when the Packet Data feature is activated and active data session is in progress.
	RUI Packet Data – Indicates Pseudo Log On state when the Packet Data feature is activated and the external device sets up data connection with the radio.
	Emergency – Indicates that the radio is in Emergency Operation. <ul style="list-style-type: none"> • Solid – Emergency Operations initiated. • Blinking – the radio is in emergency receiving state.

Icon	Description
	Disaster Alert Call – Indicates that the radio is in Disaster Alert Call.
	List Scrolling – Indicates that the Rotary Knob is in list scrolling mode.
	New Message Has Arrived – Indicates that a new message has arrived from a different user profile.
	New Message in Inbox – Indicates that you have unread messages in your Inbox .
	Unread (New) WAP Message – Indicates that new page was loaded to the browser.
	Call-Out – Indicates Call-Out alert.
	Call-Out Alert Arrived – Indicates a receipt of a new Call-Out message.
	Call-Out Alert Unread – Indicates unread alert in the CO Box .
	<p>End-to-End Encryption (E2EE)</p> <p>Solid, when the E2EE is enabled:</p> <ul style="list-style-type: none"> • for the selected talkgroup, • for the highlighted private number, • for the manually entered private number, • when transmitting voice in Group Calls, • when transmitting voice in Simplex Private Calls. <p>Blinking, when the E2EE is enabled:</p> <ul style="list-style-type: none"> • when receiving voice in Group Calls, • when receiving voice in Simplex Private Calls, • during encrypted Duplex Private Calls.
	<p>Encryption Off</p> <p>Blinking – Indicates that the SIM Card E2EE is disabled in DMO and TMO Modes.</p>
	<p>SIM End-to-End Encryption (E2EE) in TMO</p> <p>Indicates that the SIM Card E2EE is enabled in TMO Mode.</p>
	<p>SIM End-to-End Encryption (E2EE) in DMO</p> <p>Indicates that the SIM Card E2EE is enabled in DMO Mode. Numbers 1 and 2 point to the type of DMO Encryption keys that has been selected.</p>
	<p>Unread (New) WAP Message – Indicates that you have not entered WAP Box since last WAP message was received.</p> <p>Blinks when the priority is high.</p>
	<p>WAP Message Icon – Displayed next to the priority WAP message in the message list view.</p>

Icon	Description
	WAP Message Time – Displayed next to the create date in the message list view.
	WAP Message Expiration – Displayed next to the expiry date in the message list view.
	WAP Message Title Icon – Displayed next to the title along with the text in the message list view.
	Keys Locked – Indicates that keys are locked.
	Non-Secured Call – Air Encryption Unavailable Blinking – Indicates that Air Encryption is not available when the radio: <ul style="list-style-type: none"> • is in the Local Site Trunking Mode. • attempts to connect to a gateway.
	Non-Secured Call – Air Encryption Unavailable Blinking – Indicates that Air Encryption is not available in DMO Mode. The icon appears after the PTT button is pressed.
	Remote Control – Indicates that the radio is being remotely controlled and some commands are being executed in the background. For example, when the radio is being controlled by special SDS messages or triggered to send a GNSS location report.
	Radio Selection – Indicates that the next available radio is selected.
Enhanced Dual Control Head	
	Dual Control Head – Indicates that Dual Control Head feature is enabled, and both control heads are connected to the transceiver.
	Single Control Head – Indicates that Dual Control Head feature is enabled, but only one control head is connected to the transceiver.
	Link Error – Indicates that connection between the control head and the transceiver has been lost, for example, due to an error.
	Key Press Token – Indicates that one of the control heads reserves the key press token.
	CH1 – Indicates that particular activities or settings apply to Control Head 1. Control Head 1 is a control head connected to port 1 on the expansion head.
	CH2 – Indicates that particular activities or settings apply to Control Head 2. Control Head 2 is a control head connected to port 2 on the expansion head.
	Speaker 1 Off (Low Audio) – Indicates that audio will not sound through the speaker of the Control Head 1.
	Speaker 2 Off (Low Audio) – Indicates that audio will not sound through the speaker of the Control Head 2.
	Speakers Off (Low Audio) – Indicates that speakers of both control heads are off.
	All Tones Off / Duplex and Simplex Ring Muted – Indicates that all alert tones are off, or both simplex ring volume is set to 0 and duplex ring volume is set to 0. Applicable to Control Head 1.

Icon	Description
	Simplex Ring Muted – Indicates that simplex ring volume is set to 0 and duplex ring volume is set to more than 0. Applicable to Control Head 1.
	Duplex Ring Muted – Indicates that duplex ring volume is set to 0 and simplex ring volume is set to more than 0. Applicable to Control Head 1.
	All Tones Off / Duplex and Simplex Ring Muted – Indicates that all alert tones are off, or both simplex ring volume is set to 0 and duplex ring volume is set to 0. Applicable to Control Head 2.
	Simplex Ring Muted – Indicates that simplex ring volume is set to 0 and duplex ring volume is set to more than 0. Applicable to Control Head 2.
	Duplex Ring Muted – Indicates that duplex ring volume is set to 0 and simplex ring volume is set to more than 0. Applicable to Control Head 2.

2.9

During a Call

During the call, label of the right Soft key indicates the next possible change. Accessory default setup is:

Table 11: During the Call

Soft Key Label	Audio Setting
Spkr	Audio goes to the main speaker (<i>Speaker HIGH</i> is displayed)
Erpce	Audio goes to the earpiece (<i>Speaker LOW</i> is displayed)

2.10

Selecting Talkgroups

Follow these procedures to select talkgroup manually. If the selected talkgroups is an InterSystem Interface (ISI) talkgroup, your radio can migrate to another talkgroup linked network, changing the talkgroup automatically.

Procedure:

From the home screen, use one of the following methods:

- Press **Left** or **Right** Navigation key. Press **Select** to confirm.
- Select **Options** → **TG by abc**. Enter a talkgroup name and select the talkgroup name from the list.
- Select **Options** → **TG by Folder**. Select a folder (for example, **Favorite**) and then a talkgroup name.



NOTE: Your radio can access up to three levels of the folder structure.

- Press **Rotary Knob** and rotate it until the required talkgroup name is displayed. Press **Select** to confirm.



NOTE: If the **Rotary Knob** mode is set to Scroll, then you do not need to press it to enter the scrolling mode.





2.10.1





Talkgroup Icons Selection

Talkgroup icons are used to indicate that a talkgroup has a special function, show the status of network selection, and/or show the talkgroup properties. A talkgroup without an icon does not have a special function attached to it.

These icons are displayed next to the talkgroup alias on idle display and when scrolling talkgroups in common or favorite folder lists.

Table 12: Talkgroup Icons

Icon	Talkgroups in Common Folders	Talkgroups in Favorite Folders
TMO Talkgroup Icons		
	<p>In TMO Mode Display when the talkgroup selected is a SIM TMO talkgroup, and not registered to SIM network. Single network is available.</p>	<p>In TMO Mode Display when the talkgroup selected is a SIM TMO talkgroup, and not registered to SIM network. Single network is available.</p> <p>In DMO Mode Display when the talkgroup selected is a SIM TMO talkgroup. Single network is available.</p>
	<p>Not displayed in common folders.</p>	<p>In TMO Mode Display when the talkgroup selected is a normal TMO talkgroup. Single network is available.</p> <p>In DMO Mode Display when the talkgroup selected is a normal TMO talkgroup. Single network is available.</p>
	<p>In TMO Mode Display when the talkgroup selected is an ISI or Any network TMO talkgroup. Multiple networks are available.</p>	<p>In TMO Mode Display when the talkgroup selected is an ISI or Any network TMO talkgroup. Multiple networks are available.</p> <p>In DMO Mode Display when the talkgroup selected is an ISI or Any network TMO talkgroup. Multiple networks are available.</p>
	<p>In TMO Mode Display when TMO ISI talkgroup selected is not assigned to home network. Multiple networks are available.</p>	<p>In TMO Mode Display when TMO ISI talkgroup selected is not assigned to home network. Multiple networks are available.</p> <p>In DMO Mode Display when TMO ISI talkgroup selected is not assigned to home network. Multiple networks are available.</p>

Icon	Talkgroups in Common Folders	Talkgroups in Favorite Folders
	In TMO Mode Display when the TMO normal talkgroup selected is not assigned to the current network. Single network is available.	
DMO Talkgroup Icons		
	Display when a DMO talkgroup is selected.	
General Icons		
	Display when the radio is registered to a network that is not the home network.  NOTE: The icon, also known as Migration icon, is only displayed on the top of the display as a status icon.	
	Display when the radio is locked to a current network selection that is a single network while the current selected ISI talkgroup or Any Net talkgroup allows multiple networks.	

 **NOTE:** In common folders, no TMO talkgroups are shown when in DMO mode.

2.11

Entering TMO or DMO Mode

Procedure:

1. From the home screen, press **Options**.
2. Select **Trunked Mode/Direct Mode**.

2.12

Using Timed Talkgroup Change

This feature allows you to switch a selected talkgroup between the currently selected talkgroup and a predefined talkgroup (TMO or DMO), making the predefined talkgroup the selected talk group for a predefined time by using a One-Touch Button (OTB). After the timer expires, your radio returns to the previously selected talkgroup.

Prerequisites: Timed Talkgroup Change is assigned to an OTB.

Procedure:

1. Press the programmed OTB.
2. Your radio switches the selected talkgroup to the predefined talkgroup for a predefined amount of time.

During the predefined time your radio initiates or joins group communication (SDS, status SDS, or call) on the predefined talkgroup as the selected talkgroup.

Your service provider can assign a function to the second press of the OTB to:

- Return to previously selected talkgroup
- Restart the predefined time
- No action

- When the timer expires (potentially after being restarted a number of times) your radio switches to the previously selected talkgroup.

2.13

One-Touch Buttons

The One-Touch Button (OTB) feature allows you to activate a feature by a long key press of the programmable button. Your service provider can also assign one-touch functions to the keypad keys.

 **IMPORTANT:** Do not press any key until the radio is powered up.

 **NOTE:** The One-Touch Button and One-Touch Dial are mutually exclusive features.

Table 13: One-Touch Button Features

Feature	Description
Activation of Covert Mode	Turns Covert Mode on or off.
Any Network	Selects any network.
Any Talkgroup Network	Selects any talkgroup network.
Change Talkgroup	Changes the talkgroup to the one programmed by your service provider.
Display Operational-Tactical Address (OPTA)	Displays the OPTA.
DMO Pre-emptive Short Data Service (SDS)	Sends the next DMO SDS or status message with elevated priority.
Home Only	Selects only home network.
Home Talkgroup on Home Network	Selects only home network and home talkgroup network.
Inactive One Touch Key 0	The one-touch function assigned to the 0 key remains inactive until you long press the button twice.  NOTE: A single long press on the 0 button calls out the + symbol.
Initiate Call-Out Fallback	Sends a Call-Out Fallback Alert.
Location Information Protocol (LIP) Report	Sends a message with the location of the radio to a dedicated address or Selected Talkgroup (DMO Only).
Lock to Current Network	Selects the current network only.
Phone and Private Automatic Branch Exchange (PABX) Call Setup	Initiates a PABX call to a predefined entry in the contact list.
Phone Call Setup	Initiates a phone call to a predefined entry in the contact list.
Prefer Talkgroup Network Shortcut	Displays the Prefer Talkgroup Network menu.
Private Call Setup	Initiates a simplex or duplex private call to a predefined entry in the contact list or to the last group call originator.
RMS Mode Activation or Deactivation	Toggles the RMS feature on or off.

Feature	Description
Radio User Identity (RUI) Logon or Logoff	Toggles the RUI feature of the radio.
Select Next Radio	Selects the next available radio.
Select Talkgroup Network Shortcut	Displays the Select Talkgroup Network menu.
Send Double Push PTT Tone (D-PTT)	Sends the D-PTT tone to the currently used talkgroup.
Send Predefined Template (PDT)	Sends a predefined message to a dedicated address.
Send Status Message	Sends a dedicated status message to a dedicated address.
Send User-Defined Template (UDT)	Sends a user-defined message to a dedicated address.
Speaker Enable or Disable per Call	Enables or disables the loudspeaker for a duration of the ongoing call.
Switch to Previously Selected Talkgroup	Changes the talkgroup of the radio to the previously selected talkgroup (DMO or TMO).
Timed Talkgroup Change	<p>Makes a predefined talkgroup the selected talkgroup for a specified amount of time. While you are using the predefined talkgroup, the second press of the One-Touch Button results in:</p> <ul style="list-style-type: none"> • the radio returning to the original talkgroup. • the radio restarting the timer before returning to the previously selected talkgroup. • no action on the radio, depending on the configuration. <p>After the timer expires, the radio returns to the previously selected talkgroup.</p>
Toggle Backlight	Toggles the backlight on or off.
Toggle Backlight Intensity	Regulates the backlight intensity.
Toggle BSI Encryption Enabled or Disabled	Enables or disables BSI encryption.
Toggle Call Forwarding	Toggles Call Forwarding on or off.
Toggle DMO or TMO	Toggles between TMO and DMO modes.
Toggle Hi or Low Audio	Toggles audio between the external earpiece and the main speaker.
Toggle Hearer Speaker Microphone (HSM) Secondary Accessory Connection	Activates or deactivates the HSM Secondary Accessory.
Toggle Horn and Lights	Toggles the horn and lights indication.
Toggle Speaker During Call	Enables or disables the loudspeaker during a call.
Toggle Talkgroup Scan	Turns the Talkgroup Scan feature in TMO Mode on or off.
Toggle Transmit Inhibit Mode (TXI)	Turns TXI on or off.

Feature	Description
Turn Gateway Mode On or Off	Turns Gateway Mode on or off.
Turn Repeater Mode On or Off	Turns Repeater Mode on or off.
Unassigned	The radio displays <code>Unassigned Button</code> when no feature is assigned to this button.
Universal Time Display	Displays universal time on the home screen.

Chapter 3

Modes

This chapter contains information on available modes that the radio can operate in.

3.1

Trunked Mode Operation

Trunked Mode Operation (TMO) requires the switching and management infrastructure.

TMO enables various voice and data communication types. Examples are group calls and short data service messages. TMO also enables access to features related to infrastructure such as packet data.

Figure 2: Trunked Mode Operation

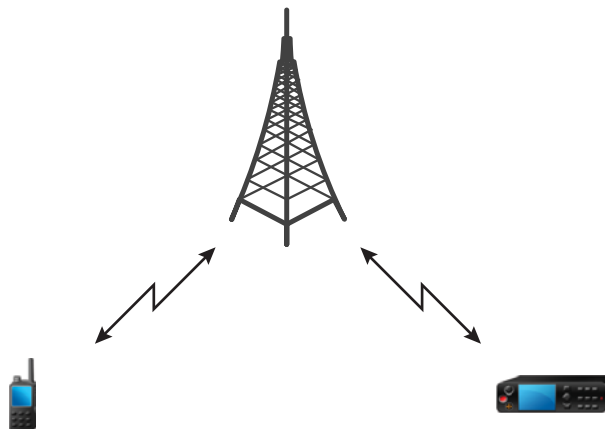

3.1.1

Entering TMO Mode

Procedure:

1. Perform one of the following actions:
 - From the home screen, press **Options**.
 - From the home screen, press the **Menu** key. Select **Networks**.
2. Select **Trunked Mode**.

3.1.2

Making Group Calls in TMO

The Group Call is received by all members of the selected group who have their units turned on and are connected through the network.

Procedure:

1. Press and hold the **PTT** button.

2. Wait for the *Talk Permit* tone (if configured) and then speak into the microphone. Release the **PTT** button to listen.

 **NOTE:** To cancel making a group call, do one the following actions before the talk permit is granted (depending on your service provider's settings):

- Release the **PTT** button.
- Press the **END** key (default).

When the call is canceled, your radio displays `Call Cancelled` message (if configured by your service provider).

3.1.3

Receiving Group Calls in Idle

Procedure:

1. Your radio receives a Group Call.

 **NOTE:** The incoming Group Call is signaled by a *Receiving Group Call* tone.

2. To respond, press and hold the **PTT** button.

3.1.4

Receiving Group Calls during Ongoing Group Calls

While in active Group Call, your radio receives a Group Call with a higher priority.

One of the following occurs:

- Your radio is forced to end the current group call and automatically join the incoming one.
- Your radio displays incoming group call screen with options:
 - **Join** – ends current Group Call and starts the incoming one.
 - **End** – cancels the incoming Group Call.

3.1.5

D-PTT Preempt Group Call

 **NOTE:** This is a Software Selling Feature.

The D-PTT Preempt Group Call allows superiors to take over and speak in an ongoing group call by making preemptive priority calls.

 **NOTE:** Your radio can support either the D-PTT Tone feature, or D-PTT Preempt Group Call feature at a time only.

By pressing the PTT (Push-To-Talk) button twice, you make a preemptive request to temporarily interrupt an ongoing group call and gain permission to speak.

If your group call is preempted and you are still pressing the **PTT** button, your radio displays the `PTT Denied` prompt.

If your service provider enables the visual notification, your radio displays the `PTT Interrupted` prompt throughout the group call preemption, even if you no longer hold the **PTT** button.

If your service provider enables the audio notification, your radio plays the `PTT Denied` Tone until you no longer hold the **PTT** button.

3.1.5.1

Preempting Group Calls



NOTE: Your radio can only support either the D-PTT Tone feature or D-PTT Preempt Group Call feature at a time.

Procedure:

1. Your radio receives a Group Call.
2. Press the PTT button twice on the radio or the Remote Control Unit (RCU).
Call preempt is triggered.

3.1.6

Dynamic Group Number Assignment (DGNA)

DGNA allows the network operator to dynamically manage talkgroups on your radio over the air interface. Using DGNA, the network operator can:

- Add talkgroups.
- Attach or select newly added talkgroups.
- Delete talkgroups.
- Modify parameters of existing talkgroups.

All the above operations are performed by transmitting data to your radio.

3.1.6.1

DGNA Reception

When a Dynamic Group Number Assignment (DGNA) message is received, your radio plays a tone and displays a message `Talkgroup list updated`. If enabled by your service provider, your radio displays all added and deleted talkgroup list.

When your service provider deletes (deassigns) the currently selected talkgroup, depending on the settings, your radio can perform one of the following actions:

- Enters the “No Group” state – your radio does not attach to any talkgroup automatically.
- Attaches to the last selected TMO talkgroup. If the last selected TMO talkgroup is not available (it was deleted), your radio enters the “No Group” state.
- Attaches to a default talkgroup configured by your service provider. If the default talkgroup is not available (it was deleted), your radio enters the “No Group” state.

At each talkgroup change, an appropriate notification is shown on the display.

If the DGNA message is received to delete all talkgroups, your radio displays `All Talkgroups Deleted`. To exit the DGNA display, you can use the **Back** Soft key or the **End** key.

3.1.6.2

DGNA Auto Select Group

If the Dynamic Group Number Assignment (DGNA) Auto Select is configured, whenever your radio receives a DGNA, it switches to the added talkgroup.

3.1.6.3

DGNA Auto Reselect Group

Dynamic Group Number Assignment (DGNA) Auto Reselect allows your radio to return to the previously selected talkgroup. Your network operator assigns a talkgroup to your radio through DGNA. When the assigned talkgroup is deassigned, your radio automatically returns to the previous talkgroup.

3.1.6.4

Viewing DGNA Talkgroups

Prerequisites: Your radio receives the Dynamic Group Number Assignment (DGNA) message.

Procedure:

1. To view the added talkgroups details, press **View**.
2. Scroll to select the required talkgroup.
3. To select a DGNA group, press **Attach**.

3.1.7

Broadcast Call

Broadcast Group Call (also called Site Wide Call) is a high-priority group call from the console operator (or dispatcher) to all users located at one or more sites. The radios are configured to monitor a Broadcast Call, but you cannot talk back. The call can be received as a normal Broadcast Call or an Emergency Broadcast Call. The Broadcast Call preempts an ongoing Group Call that has the same or lower call priority.

In TMO mode, broadcast call can be forwarded from the Gateway to a DMO open talkgroup or Attached DMO Talkgroup if configured.

3.1.7.1

Broadcast Calls Initiated by Users

This feature allows you to make a Broadcast Call from the radio that is initiated on the predefined talkgroup. Your service provider predefines the alias and the priority of the Broadcast Call.



NOTE: If the type of the encryption is defined by the SIM Card, the Broadcast Call is always clear. Otherwise if the radio uses other encryption service the type of the encryption used for that Call is up to the encryption settings of that service.

This feature is not supported on the Dimetra infrastructure.

3.1.7.2

Initializing Broadcast Calls

Procedure:

1. From the home screen, press the **Menu** key.
2. Select **Services** → **Broadcast**.
Your radio displays the predefined alias and the Broadcast Call icon.
3. To start the call press the **PTT** button.

3.1.8

Assistance Call

This feature allows you to make private calls to ask for assistance in normal and noncritical situations. To initiate an assistance call, you can select the target address from up to five configured numbers.



NOTE: Your service provider can configure the number, priority, and the type of the call (simplex or duplex).

You can start an Assistance Call using one of the following methods:

- Dial a predefined number and press **Send** key.
- **Menu** → **Services** → **Assistance Call**

3.2

Local Site Trunking

This mode is also known as Fallback Mode and it allows more than one radio from the same site to communicate when the link between the site and the network central controller fails. Entering and exiting Local Site Trunking (that is, returning to System Wide Services) is done automatically. In this mode, some services are unavailable.



NOTE: Your service provider can disable this mode.

3.2.1

Entering Local Site Trunking

When your radio receives a Local Site Trunking indication from the system, the following occurs:

- Your radio sounds an *Entering Local Site Trunking* tone.
- Display shows the `Local Area Service` message.



NOTE: Noticeable only on the color display.

- Any call in progress is dropped upon entering Local Site Trunking Mode.

If configured by your service provider, this message/alert is periodically repeated to remind you that your radio is still operating in Local Site Trunking Mode. The following features are available:

- Registration
- Attachment
- Group Call
- Emergency Operations



NOTE: Your service provider can turn on/off all visual and audio indications, when you enter Local Site Trunking Mode.

3.2.2

Exiting Local Site Trunking

When the link with the central network controller is reestablished, your radio exits Local Site Trunking, and the following occurs:

- Your radio plays an *Exiting Local Site Trunking* tone.
- Any call in progress during Local Site Trunking is dropped.

- Display icons and soft keys turn blue.

 **NOTE:** Your service provider can turn on/off all the visual and audio indications, when you exit Local Site Trunking Mode.

3.3

Direct Mode Operation

Direct Mode Operation (DMO) is a mode of simplex operation where radios communicate directly without the need of a network.

 **NOTE:** For those who use DMO mode, you are recommended to apply DMO SCK for data confidentiality.

Figure 3: Direct Mode Operation



3.3.1

Entering DMO Mode

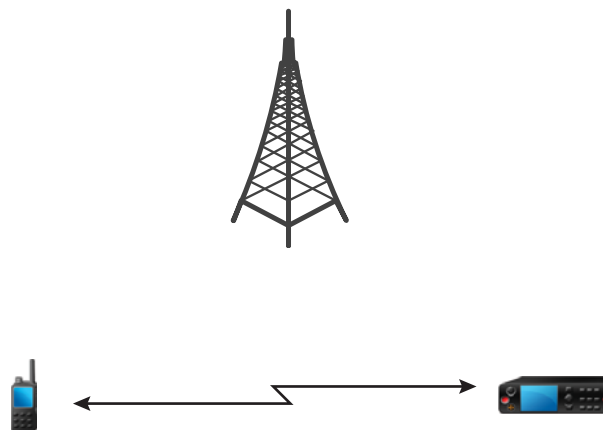
Procedure:

To enter the DMO Mode:

- From the home screen, press the **Menu** key. Select **Networks** → **Direct Mode**.
- From the home screen, press the **Menu** key. Select **Options** → **Direct Mode**.

3.3.2

Making Group Calls in DMO

The Group Call is received by all members of the selected group who have their units turned on and are in range.

Procedure:

1. Press and hold the **PTT** button.
2. Wait for the *Talk Permit* tone (if configured) and then speak into the microphone. Release the **PTT** button to listen.

3.3.3

Receiving Group Calls in Idle

Procedure:

1. Your radio receives a Group Call.

 **NOTE:** The incoming Group Call is signaled by a *Receiving Group Call* tone.

2. To respond, press and hold the **PTT** button.

3.3.4

D-PTT Preempt Group Call

 **NOTE:** This is a Software Selling Feature.

The D-PTT Preempt Group Call allows superiors to take over and speak in an ongoing group call by making preemptive priority calls.

 **NOTE:** Your radio can support either the D-PTT Tone feature, or D-PTT Preempt Group Call feature at a time only.

By pressing the PTT (Push-To-Talk) button twice, you make a preemptive request to temporarily interrupt an ongoing group call and gain permission to speak.

If your group call is preempted and you are still pressing the **PTT** button, your radio displays the **PTT Denied** prompt.

If your service provider enables the visual notification, your radio displays the **PTT Interrupted** prompt throughout the group call preemption, even if you no longer hold the **PTT** button.

If your service provider enables the audio notification, your radio plays the PTT Denied Tone until you no longer hold the **PTT** button.

3.3.4.1

Preempting Group Calls

 **NOTE:** Your radio can only support either the D-PTT Tone feature or D-PTT Preempt Group Call feature at a time.

Procedure:

1. Your radio receives a Group Call.
2. Press the PTT button twice on the radio or the Remote Control Unit (RCU).
Call preempt is triggered.

3.3.5

Selecting DMO Communications Options

When and where to use: Helps to communicate with other radio users on the same talkgroup through the Gateway or Repeater.

Procedure:

1. From the home screen, press **Options**.
2. Press **Config**.

3. Select one of the following options:

- **MS - MS** – Your radio can communicate only with other radios within its range.
- **Gateway** – Your radio uses a gateway to communicate with the infrastructure.
 - **Automatic** – Your radio uses the first available gateway for that talkgroup.
 - **Specific** – Your radio uses only the Gateway with the specified Gateway address for that talkgroup. If your radio displays `Selected Gateway: None`, press **Edit** to enter the current gateway address.
- **Repeater** – Uses the first available repeater for that talkgroup.
- **GW + Rep** – Uses the first available gateway or repeater for that talkgroup.
 - **Automatic** – Uses the first available gateway for that talkgroup.
 - **Specific** – Uses only the Gateway with the specified Gateway address for that talkgroup. If your radio displays `Selected Gateway: None`, press **Edit** to enter the current Gateway address.

 **NOTE:** When the Gateway and the Repeater cannot be communicated even though a talkgroup to use them is configured, the radio attempts the direct MS-MS communication.

Result: When your radio detects the appropriate Gateway and/or the Repeater, the Gateway and/or Repeater icons turns solid, respectively.

3.3.6

Private Call with Presence Check

This feature allows you to see if the calling party is available in Direct Mode Operation (DMO). When this feature is enabled, you can only initiate a Private Call if the called radio is present on the same channel and responds with a presence check acknowledgment.

Otherwise your radio displays `Party Not Available`.

3.3.7

DMO Private Priority Call

The service provider may assign Pre-emptive Priority to outgoing Direct Mode Operation (DMO) Private Calls. If this is the case, DMO Private Calls from this radio preempt any ongoing calls (except emergency calls or ongoing Pre-emptive Priority Private Calls) on the receiving radio, which then displays `Call-preempted`.

3.3.8

Talkgroup for Individual Calls

Talkgroup for Individual Calls is a talkgroup that operates on a separate frequency allocated for individual (private) calls only. Using this talkgroup optimizes frequency resources and helps not to block other talkgroups. The only supported call types are: private calls and emergency calls (both private and group). Use this talkgroup each time you need to make a private call.

When you select a Talkgroup for Individual Calls, your radio is not able to receive or initiate any group or broadcast calls with priority lower than Emergency.

When you have selected a Talkgroup for Individual Calls and press the **PTT** button to start a Group Call, your radio:

- Rejects the call
- Plays a tone

- Displays the *Individual Calls Only* message

3.3.9

Network Monitor

 **NOTE:** This is a Software Selling Feature.

This feature allows your radio to monitor for Trunked Mode Operation (TMO) individual calls while maintaining Direct Mode Operation (DMO) services.

When Network Monitor is active, your radio receives direct calls addressed to the selected DMO talkgroup, private DMO calls, Short Data Service (SDS) messages, and also private TMO calls.

The group calls, private calls, and SDS messages initiated are configured in DMO. Only responses to private TMO calls are sent in TMO.

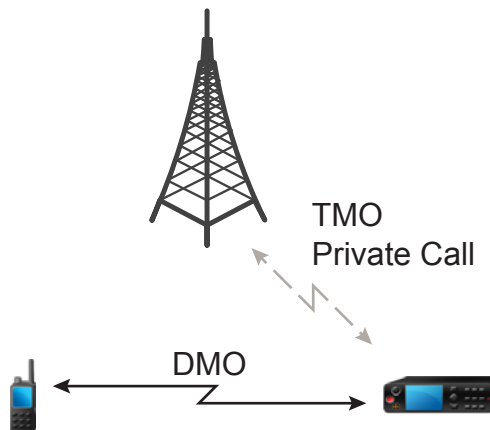

3.3.9.1

Enabling Network Monitor

Procedure:

1. From the home screen, press **Options**.
2. Select **Network Monitor**.

3.3.10

Communication Through Repeaters

Radios that are out of range and cannot communicate directly with each other in Direct Mode Operation (DMO) can do it through the repeater. The repeater is a radio that repeats all communication on a chosen channel, and as a result increases radios DMO range.

Figure 4: Communication Through Repeaters

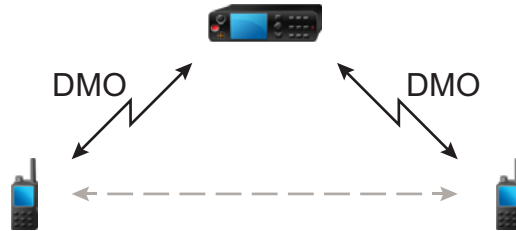

When your radio detects a potential repeater signal or connects to a repeater, it plays a tone, displays the `Repeater available` message, and shows an appropriate icon. When your radio loses connection with the repeater, it plays a tone, displays the `Repeater not available` message, and the repeater icon is blinking.

When your radio is on a Gateway mode, it switches to Gateway mode from TMO if your radio enters an emergency.

Turning off your radio or exiting the Gateway mode is restricted when the gateway is forwarding an emergency call.

3.3.11

Communication Through Gateways

Gateway provides connectivity between radios operating in Direct Mode Operation (DMO) and the TETRA network, so that the DMO radios can communicate with radios operating in Trunked Mode Operation (TMO).

Figure 5: Communication Through Gateways

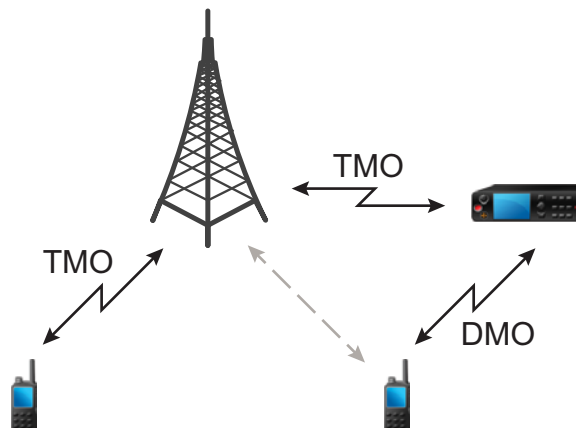

Radio behavior when radio detects a potential repeater signal or connects to a gateway:

- A tone sounds.
- The display shows `Gateway available`.
- The display shows an appropriate icon.

Radio behavior when radio loses connection with the gateway:

- A tone sounds.
- The display shows `Gateway available`.
- The display shows an appropriate icon.

Radio behavior when group call is in queue:

- The display shows `Please Wait`.

Radio behavior when entering Local Site Trunking:

- A tone sounds.
- The display shows `Local Area Service`.

3.3.12

Gateway and Repeater Synchronization

To communicate using gateways or repeaters, your radio requires synchronization with a gateway or a repeater.

A gateway or a repeater sends presence signals to radios. If a radio receives presence signals, it stays synchronized with the gateway or the repeater, which sends the signals. If a radio fails to receive a presence signal it does not immediately lose synchronization. Your radio waits for another successful presence for a time defined by your service provider. This function ensures that communications are not dropped due to temporary reception issues.

If a gateway or a repeater is unavailable or your radio is not synchronized with a gateway or a repeater, depending on the setup configured by your service provider, the following scenarios apply:

- Your radio falls back to Direct Mode Operation (DMO).
- After pressing the **PTT** button, a prompt appears warning that the second press overrides the gateway or repeater operation mode.
- No direct DMO communications are permitted.

In the second scenario, while your radio receives individual calls and group calls, and replying to individual calls is possible, replying to group calls is not possible.

3.4

Transmit Inhibit Mode

The Transmit Inhibit (TXI) Mode is a mode in which the radio sends no radio transmissions. Activate this mode in RF sensitive areas, for example hospitals, airplanes, where safety can be jeopardized due to transmission radiation.

To activate, select **Menu** → **Networks** → **TXI Mode** → **Activate**.

In this mode, the radio does not transmit under any circumstances except for the Emergency Calls. All the functions and keys which cause transmission, for example registration to the network, changing talkgroup or folder, sending SDS messages, or pressing the **PTT** button are disabled. Any transmission trial causes the radio to display `Not Allowed In TXI Mode` notification and to play a tone.

Your radio can still receive:

- Group calls
- Messages - stored in the **Inbox**
- Private call attempts - stored in the **Missed Calls** list, without the option to respond

When no danger to safety exists anymore, for example, when you leave the RF sensitive area, you can deactivate the TXI Mode and the radio returns to standard operation.

You can deactivate the mode by selecting **Menu** → **Networks** → **TXI Mode** → **Deactivate**, pressing One-Touch Button, or implicitly when initiating an Emergency Call.



NOTE: RF Transmissions from the radio are prevented under the following conditions:

- TXI Mode is activated.
- The radio is turned off.

On entering or exiting the TXI mode, when the radio is camped on a cell, it sends a specially designated Short Data Service (SDS) status message. This SDS message indicates to the SwMI that the radio is entering or exiting TXI mode.

Mobility procedures that do not require the radio to send an uplink transmission are performed except for cell reselection.

In TXI mode, the radio joins group calls for any group that the radio is monitoring, but the transmitting on that call is still prohibited.

The radio also displays any incoming SDS messages to the user. The missed call feature is active in the TXI mode and allows checking what calls were missed. However, the radio attempts to prevent call setup retransmission from being recorded as separate calls.

If you initiate an emergency call, the radio immediately leaves TXI mode and attempts to start the emergency call if the radio is in service.

If the radio is turned off in the TXI mode, on turning on, the radio asks whether to exit the TXI mode. If you choose **No**, the radio turns off.

3.5

Emergency Operations

Emergency Operations are used in critical situations.

Pressing and holding the **Emergency** button, or entering the Emergency Number and pressing the **Send** key, activates one or more services (depending on your service provider settings).



NOTE: It is possible to turn on the radio by pressing the **Emergency** button. Depending on the service provider settings, the radio can start Emergency Operations automatically. If the radio is PIN-protected (except for SIM PIN), Emergency Operations bypass the PIN lock.

When starting Emergency Operations, any ongoing voice call is aborted or cleared down, and any packet data transfer in progress is aborted. However, the session is kept open.

During Emergency Operations, the radio rejects phone, PABX, and private calls, and does not monitor the talkgroups in the selected scan list.

To terminate Emergency Operations, press the **Upper** soft key.

3.5.1

Emergency Alarm

The Emergency Alarm is a special status message. Your radio sends the message in either TMO or DMO.

Your radio sends the message each time it enters Emergency Operation. An audible tone sounds for a successfully sent message. To resend the message, press the **Emergency** button.

Emergency Alarm in DMO mode can be configured to send in all DMO modes or when your radio is synced through Gateway.



NOTE: During Hot Microphone transmission, your radio is not allowed to resend the message.

3.5.2

Emergency Group Call

The Emergency Group Call has the highest communication priority and it is a pre-emptive call. Emergency Group Call is available in both TMO and DMO. During Emergency Operations, start Emergency Group Call by pressing the **Emergency** button. Your radio can also support Hot Microphone operation, which allows the Emergency Call to be conducted without pressing the **PTT** button.

When a radio receives or generates a group call with emergency priority, the display changes color to red and a red triangle icon is displayed. A special *alert* tone is played.

An emergency group call can be configured as:

- A non-tactical call – initiated on a talkgroup preprogrammed by your service provider. When in non-tactical emergency mode, you cannot switch talkgroups.
- A tactical call – initiated on the currently selected talkgroup.

Pressing the **Emergency** button during an ongoing emergency broadcast call has no effect. No new call is started and no emergency alert is sent.

When the Emergency Group Call you participate in terminates, your radio can behave in several ways, depending on your service provider settings:

- If you are the call initiator, the radio can either stay in the Emergency Mode, or return to TMO.
- If you are not the call initiator, the radio always returns to TMO.

3.5.2.1

Making Emergency Group Calls

Prerequisites: Ensure that your radio is in Emergency Mode.

Procedure:

1. Press and hold the **PTT** button.
2. Wait for the *talk permit* tone (if configured) and talk.
3. Release the **PTT** button to listen.



NOTE: It is possible to cancel a triggered emergency group call in TMO. To do this, perform one of the following actions before the talk permit is granted (depending on your service provider settings):

- Release the **PTT** button.
- Press the **End** key (default).

When the call is canceled, your radio displays `Call Cancelled` message (if configured by your service provider).

3.5.2.2

Receiving Emergency Group Calls

The radio receives an Emergency Group Call from a selected preprogrammed group. An appropriate tone, status icon, and red color of the display indicates an incoming call.

3.5.3

Non-Tactical Emergency

In Non-Tactical Emergency, your radio switches to a designated Emergency talkgroup when starting Emergency Operations. This talkgroup is used for the complete duration of the Emergency Operation. Changing talkgroups is not allowed at this point.

In Trunked Mode Operation (TMO), your radio can make Emergency Non-Tactical Group Calls without sending attachments. If configured, the radio assumes implicit attachments after receiving a temporary address.

In Direct Mode Operation (DMO), the Non-Tactical Emergency proceeds on the same frequency as the previously selected talkgroup. The service provider can designate any Individual TETRA Subscriber Identity (ITSI) address to be used for Emergency Operations. This ITSI can be an Open Group - broadcast address.

After exiting from Non-Tactical Emergency, your radio returns to the previously selected talkgroup.

3.5.4

Emergency Individual Calls (Private or MSISDN)

The Emergency Individual Calls are simplex or duplex calls with emergency priority.

On pressing the **Emergency** button, your radio initiates an individual call to a provisioned private .

This feature also supports the direct or hook dialing method on simplex and duplex calls. For full duplex Emergency Individual Calls initiated to an MSISDN address, the default dialing method is configured to hook. This default dialing method cannot be modified.

In Emergency Individual Calls, your radio rejects all incoming individual calls with non emergency priority. These rejected calls are shown as missed calls after the Emergency Individual Calls have ended.

3.5.5

Emergency SDS Status

The radio sends a status message with a preprogrammed value to the destination address set by your service provider. Emergency SDS Status is available in TMO only. If no status acknowledgment or negative acknowledgment is received, the radio retries sending the message. Status is not resent when Emergency Alarm is configured.

3.5.6

Emergency Hot Microphone

The Hot Microphone allows you to talk without pressing the **PTT** button during Emergency Operation. The transmission continues for a provisioned amount of time. If configured, pressing the **PTT** button before the Hot Microphone time expires ends the Hot Microphone operation. Then normal PTT operation in Emergency group call takes over whereby the transmission is ongoing for the time the **PTT** button is held.

Subsequent **Emergency** button presses during the Emergency Operation restart the Hot Microphone transmission.

If a talk permit is granted to another member of the group, the Emergency Call received tone is played. If configured, the radio automatically attempts to get talk permit again.

Pressing **End** soft key or **End** key ends the Hot Microphone operation.

3.5.7

Alternating Hot Microphone

The Alternating Hot Microphone is an enhancement of the Hot Microphone. After activation, the radio alternately enters transmission phases (your microphone is active) and reception phases (you can only listen) for an amount of time precisely determined by your service provider.

If this feature is enabled, you can initiate the Alternating Hot Microphone by pressing the **Emergency** button. If you want to finish earlier or skip the transmission phase, press the **End** key.

The Alternating Hot Microphone terminates when one of the following conditions is met:

- The radio exits the Emergency Mode.
- The Alternating Hot Microphone timer expires.
- The **PTT** button is pressed (if configured).
- The **Upper** soft key is pressed (only during the transmission phase).



NOTE: When the radio goes out of the service, it enters the reception phase and the Alternating Hot Microphone is on hold. When the radio is back to the service, the Hot Microphone transmission and the Alternating Hot Microphone resume.

When you are in the Emergency Mode, pressing the **Emergency** button restarts the Alternating Hot Microphone.

3.5.8

Silent Emergency Mode

The Silent Emergency Mode is a type of emergency services that provides no audible indications nor keypad tones at the entrance. All the display indications are as in the home mode. However, the radio cannot use any services except for:

- Receiving Ambience Listening
- Sending Silent Emergency Alarms
- Sending GNSS location reports



NOTE: The radio blocks any other feature that you try to activate.

If the Silent Emergency feature is enabled, the radio enters Silent Emergency Mode on pressing the **Emergency** button. After entering this Mode the radio stays in TMO or switches to it, depending on the actual state. Once in TMO, the radio sends Silent Emergency Alarm.



NOTE: If the radio is in a private or group call, the radio waits until the call ends and then enters the Silent Emergency Mode.

The radio keeps re-sending the alarm until successful sending is confirmed. After the alarm is successfully delivered, the radio stays in Silent Emergency Mode and waits for the Ambience Listening.

Your radio exits the Silent Emergency Mode, under the following conditions:

- Press **Menu** and then **#** key within 3 seconds.
- No success in sending the Silent Emergency Alarm and the maximum number of retries has been reached.
- The control room terminates the Silent Ambience Listening.

- The Ambience Listening is disconnected due to another reason.

If you turn off the radio in the Silent Emergency Mode, the radio switches to pseudo power off state. In this state, the radio appears to be turned off. However, the radio is still on and in the Silent Emergency Mode. On turning the radio on during the pseudo power off state, the radio acts as during turning on and still is in the Silent Emergency Mode.

3.5.9

Invisible Emergency

Your service provider can disable visual and audible indications on the radio in Emergency Operation. This feature is called Invisible Emergency. Invisible Emergency provides an extra layer of safety when using Emergency Operation in critical situations. Critical situations are such as a direct attack on the user.

3.5.10

Emergency Alert



NOTE: This is a Software Selling Feature.

This feature allows the radio to send emergency alerts to other radios within its Direct Mode Operation (DMO) coverage by pressing the **Emergency** button.

Even in Trunked Mode Operation (TMO), the radio monitors a special DMO emergency frequency for possible emergency alerts and responds to them by automatically joining the emergency call.

To initiate the emergency alert, the radio must be in MS-MS DMO mode or out of coverage in TMO mode. The alert is not sent to the dispatch console.

To receive the emergency alert, the radio must be in DMO or TMO, within RF range of the initiating radio, and must not be in a call. When the radio receives the emergency alert, it joins the call automatically.

The following table illustrates the dependencies between the current radio mode and the type of emergency operation:

Table 14: Emergency Operation Dependencies

Radio Mode	Initiate Emergency	Emergency Alert Received (Yes/No)
DMO, MS-MS, idle	Emergency Alert	Yes
DMO, Repeater, idle	Standard DMO Emergency	Yes
DMO, Gateway, idle	Standard DMO Emergency	Yes
DMO, in call	Per communication mode	No
TMO, no coverage	Emergency Alert	Yes
TMO, in coverage, idle	Standard TMO Emergency	Yes
TMO, in coverage, in call	Standard TMO Emergency	No
Network Monitor, MS-MS	Emergency Alert	No
Network Monitor, Repeater	Standard DMO Emergency	No
Gateway operation, in coverage	Standard TMO Emergency	No
Repeater operation	Standard DMO Emergency	No

3.5.11

Emergency Mode by Dialing

This feature allows you to trigger Emergency Mode by dialing a predefined number. It initiates the same emergency services as when you use the **Emergency** button. Your radio can store up to eight emergency numbers.



NOTE: If Emergency Mode is triggered by dialing an emergency number, you can press the **End** key to exit Emergency Mode.

3.5.12

Disaster Alert

Disaster Alert call is a broadcast emergency call initiated by the radio, with emergency pre-emptive priority that everyone in a broadcast area can hear. This feature is designed for catastrophic situations, such as earthquakes, and has the highest priority over other calls. All radios under Disaster Alert display emergency notification on their screens. The alert message, its duration, and destination talkgroup can be configured in the codeplug.

To initiate Disaster Alert, switch the radio to Disaster Alert mode and press **PTT** button. When the call ends, the radio exits the Disaster Alert state.

During Disaster Alert, other functionality is impacted:

- When Disaster Alert begins, any other ongoing services are terminated.
- No other services can interrupt this type of call.
- Hot Mic functionality cannot be used.
- Speech can only be in Clear mode, even if any of the encryption services are enabled. The only exception is E2E Encryption.



NOTE: Not all infrastructures support this feature. Consult service provider before enabling this feature.

3.5.12.1

Initializing Disaster Alert Calls

Procedure:

1. From the home screen, press the **Menu** key.
2. Select **Services** → **Disaster Alert**.
Your radio enters Disaster Alert Mode and it displays Disaster Alert icon.
3. To start the call press **PTT**.
Your radio displays `Disaster Alert In Use`.

3.5.13

Emergency Destination in Local Site Trunking



NOTE: This is a Software Selling Feature.

This feature allows the radio to send emergency requests to a different destination. This transmission occurs while in local site trunking mode.

The supported emergency services are:

- Emergency Alarm
- Emergency Call
- Emergency Short Data Service (SDS) Status
- Location Information Protocol reports

3.5.14

Exiting Emergency Operations

Prerequisites: Make sure that your radio is engaged in Emergency Operations.

Procedure:

Perform one of the following actions:

- Press **End** if your radio displays `Emergency Mic On`.
- Press and hold **Exit**.

 **NOTE:** Press the **End** key if an Emergency Operation triggered by Emergency number (not by **Emergency** button) to exit the Emergency Operation.

Result: Your radio exits Emergency Operations.

3.6

Repeater Mode

 **NOTE:** This is a Software Selling Feature.

The Repeater Mode provides repeater connectivity between radios operating in the DMO Mode.

Figure 6: Repeater Mode Operation

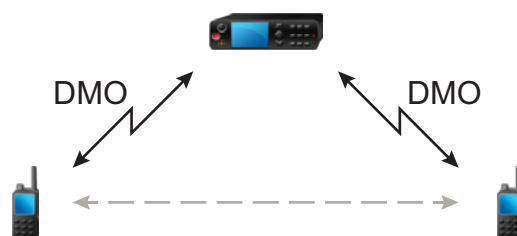

When the radio is in DMO repeater mode, it extends the DMO range by retransmitting received information from one radio to another. It retransmits group calls, private calls and data on a given frequency. In the diagram, the radio in the middle serves as a repeater.

The repeater sends presence signal periodically on a free channel to allow other radios to synchronize on a given frequency.

Only the radios on the same talkgroup can communicate with each other through the repeater.

The Repeater Mode is activated by selecting **Menu** → **Networks** → **Repeater Mode**.

3.6.1

Setting Monitor Option

Procedure:

1. From the home screen, press **Options**.
2. Press **Monitor**.
3. Select one of the following options:
 - **Off** – Your radio works as a repeater only, no operation is available.
 - **Receive Only** – Allows you to listen.
 - **Receive&Transmit** – Allows you to listen and transmit by pressing **PTT**.

3.6.2

Encryption in the Repeater Mode

While in the Repeater Mode, your radio supports Air Encryption and is able to repeat encrypted calls and messages.

If Static Cipher Keys (SCK) keys installed on your radio are invalid:

- Your radio transfers calls and messages without deciphering them (provided that the encryption level is not the highest).
- The LED indicator turns orange.
- You cannot make any calls.

3.7

Gateway Mode



NOTE: This is a Software Selling Feature.

The Gateway Mode allows your radio to work as a gateway and thus provide connectivity among radios operating in DMO and TMO Modes.

Figure 7: Gateway Mode Operation

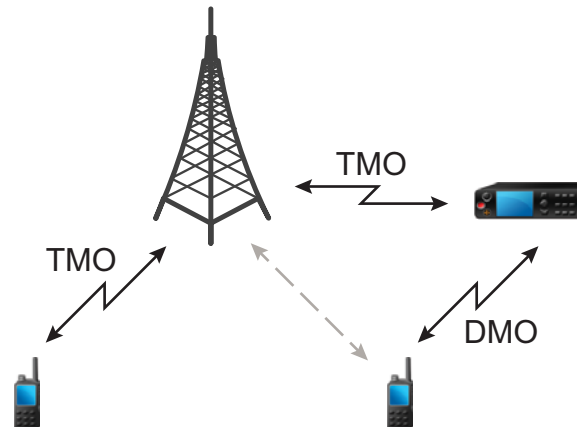

A DMO/TMO gateway is used to provide gateway connectivity between radio operation in the DMO and the TETRA TMO network. In other words, the gateway mode provides the interface between TETRA DMO and TMO modes.

While in gateway mode, individual and group calls cannot be initiated. Any active TMO scanning is also suspended, including the scanning of supergroups.

While in the gateway mode, any individual call from both DMO and TMO cannot be answered. If the call is incoming from TMO, it is rejected as the called party is busy. The missed call is added to the missed call list. If the call is incoming from DMO, it is ignored.

While in the gateway mode, group calls are supported. When the gateway receives a group call addressed to its current selected TMO talkgroup, it forwards the call on to the respective mapped DMO talkgroup. If the DMO channel is not free, and the incoming call has Emergency priority, then preemption request is sent.

When the gateway receives a group call addressed to its current selected DMO talkgroup, it forwards the call on to the respective mapped TMO talkgroup. The DMO radio that initiated the call requires correct setup for gateway calls (otherwise the call is rejected).

To prevent gateways from switching to background mode due to receiving a radio signal, your service provider sets up a signal strength threshold. Any signal with strength lesser than the threshold is ignored and the gateway continues to operate.

When in the background mode, the gateway constantly surveys the DMO channel to determine when it is free. After 10 seconds of inactivity on the DMO channel, the gateway leaves the background mode.

Gateways roam between TMO sites. To prevent disconnecting an ongoing call due to roaming, the site switch is delayed until it is no longer in range of the given site.

3.7.1

Entering Gateway Mode

Procedure:

1. From the home screen, press **Options**.

2. Select **Gateway Mode**.



NOTE: When Gateway Mode is enabled, you cannot make any calls.

3.7.2

Standby Mode

Your radio enters Standby mode if there is another Gateway on the same Direct Mode Operation (DMO) frequency.

The Gateway icon flashes and no transmission is forwarded through the gateway. To exit Standby Mode, you can:

- Choose another DMO talkgroup.
- Wait until the other gateway is out of coverage and is no longer present on that DMO talkgroup.

3.7.3

Forwarding Group Calls

Your radio shows the source and destination talkgroup of the Group call.

3.7.4

Setting Monitor Options

Procedure:

1. From the home screen, press **Options**.
2. Press **Config**.
3. Select one of the following options:
 - **Off** – Audio of the calls are not routed to the speakers of the gateway.
 - **Receive Only** – Audio of the calls are routed to the speakers of the gateway.

3.7.5

Emergency Calls in Gateway Mode

When you press the EMERGENCY button, your radio enters TMO Emergency mode and starts an Emergency Group call. Check with your service provider whether the Emergency Group call starts on a tactical or nontactical talkgroup. If your radio in Gateway mode receives an Emergency Group call, it forwards the call to the respective TMO or DMO talkgroup that is currently switched on.

3.7.6

Encryption in Gateway Mode

While in the Gateway Mode, your radio supports Air Encryption and is able to transmit encrypted calls among radios operating in TMO and DMO.

If SCK keys installed on your radio are invalid, the radio cannot function as a gateway and transmit calls.

Chapter 4

Main Menu

This chapter contains information on items in the main menu.

You can enter the menu items during a call. If not programmed otherwise by your service provider the radio exits the menu, when a new call starts.



IMPORTANT: Some menu items are model-specific and may not be activated or available on your radio.

4.1

Scrolling through the Menu

Procedure:

1. From the home screen, press the **Menu** key.
2. Scroll to the required item by pressing Navigation keys. Press the Soft key assigned as **Select** or **Right** Navigation key to select.

If the menu item contains a further set of menu items, repeat [step 2](#).







NOTE: You can use shortcuts to access frequently used items.













4.2

Menu Icons

The following icons make it easy to identify the menu items at first glance.

Table 15: Menu Icons

Menu Icon	Description
	<p>Main Menu Items/Context Sensitive Menu It is assigned to Menu when the main menu items/context-sensitive menu are active.</p>
	<p>Messages Send status messages. Send text messages (free text or according to user defined or predefined templates). Received messages in Inbox.</p>
	<p>Contacts Add, search, edit, or erase entries in the contact list.</p>
	<p>Browser Starts the WAP browser.</p>
	<p>Security Lets you turn on/off and verify security features, and change passwords.</p>

Menu Icon	Description
	Setup Allows you to customize your radio.
	Group Setup Contains additional menu items for Scanning Talkgroups features.
	Favorites Contains shortcuts to frequently used talkgroups and contact numbers.
	My Info Displays information about your radio and its numbers.
	Recent Calls Contains a list of recent calls.
	Shortcuts Allows you to view and manage shortcuts to menu items.
	RUI Allows you to log in and log out of the radio.
	Networks Allows you to select a network.
	Location Displays location of your radio.
	Packet Data Allows you to send data from your radio to other devices.
	Crypto Menu Allows you to manage SIM Card End-to-End Encryption.
	Services Allows you to manage Broadcast, Assistance, and Disaster Calls.

4.3

Messages

The messages feature allows you to send and receive text messages. A message can contain up to 1000 characters, depending on your service provider settings.

When you receive a message that cannot be decrypted, your radio displays containing the following information:

- ISSI address of the sender
- Decryption Failed: message
- Decryption fail reason: Wrong Key, No Key, or SIM Error.

You can close the notification by pressing the **Right** soft key or the **End** key.

Pressing the **PTT** button when a message is highlighted can cause one of the following actions, depending on your service provider settings:

- The radio ignores the **PTT** button request.
- The radio starts a Private Call with the message sender.
- The radio starts a Group Call on a currently selected talkgroup.

For details on writing a text message, see [Writing Text on page 24](#).

4.3.1

New Message

This menu item allows you to create a new message.

4.3.1.1

Sending Messages to Private or Phone

Procedure:

1. From the home screen, press the **Menu** key.
2. Select **Messages** → **New Message**.
3. Enter your message and press **Send**.
4. Select **Private/Phone**.
5. Enter recipient number or press **abc** to choose it from your contacts.



NOTE:

For Private target selection, you can enter either Individual Short Subscriber Identity (ISSI), Individual TETRA Subscriber Identity (ITSI), or Group Short Subscriber Identity (GSSI) of the recipient.

ISSI or ITSI is a unique and individual ID assigned to each radio.

GSSI in Dimetra is called Group ID or Talkgroup ID.

6. Perform one of the following options:
 - Select **Send**.
 - Press the **Send** key.
 - Press the **PTT** button.

4.3.1.2

Sending Messages to Groups

Procedure:

1. From the home screen, press the **Menu** key.
2. Select **Messages** → **New Message**.
3. Type your message and press **Send**.
4. If needed, select **Group**.
5. Select a group that you want to send the message to.

4.3.1.3

Sending Store and Forward Messages

Prerequisites: Ensure that your service provider enables the Store and Forward feature.

Procedure:

1. From the home screen, press the **Menu** key.

2. Select **Messages** → **New Message**.
3. Press the **Menu** key and select **Message Setup** → **On/Offline users**.
4. Enter your message and press **Send**.
5. Select one of the following options:
 - **Private** – To choose the destination number from the contact list, enter the private number or press **abc**.
 - **Phone** – To choose the destination number from the contact list, enter the phone number or press **abc**.



NOTE: Your service provider can enable sending a Store and Forward message to a talkgroup.

6. Perform one of the following options:
 - Select **Send**.
 - Press the **Send** key.
 - Press the **PTT** button.

4.3.1.4

Delivery Report

You can configure the radio to request an acknowledgment (Delivery Report), upon sending a message to an individual recipient. You can define the type of Delivery Report your radio requests, or turn this feature on and off.

If the radio receives the Delivery Report shortly after the message is sent, the radio displays the following results:

- Displays one of the following notifications:

Table 16: Description of Delivery Report Notification

Notification	Description
Message Sent	A Delivery Report is not requested and a Store and Forward message is received in the Store and Forward server.
Message Delivered	A Delivery Report is requested and the recipient receives the message.
Message Read	The Consumed Delivery Report is requested and the recipient opens the message.
Message Failed	The Delivery Report is requested and the recipient does not receive the message within the stipulated time.

- Saves the Delivery Report and a copy of the message in the **Outbox**.

If the radio receives the Delivery Report after a longer period, the radio saves the Delivery Report and a copy of the message in the **Outbox**.

If the radio receives the Delivery Report after a longer period and your service provider configures the functionality of the Delivery Report Notifications, the radio displays the following results:

- Saves the Delivery Report and a copy of the message in the **Outbox**.
- Temporarily saves the Delivery Report message in the **Inbox**. The notification disappears after it is read.
- Displays the New Message icon.
- Displays the New Delivery Status notification screen (if possible).

4.3.1.4.1

Viewing Delivery Reports

Procedure:

1. From the home screen, press the **Menu** key.
2. Select **Messages** → **Inbox**.
3. Find a required message and select **Read**.
4. Press the **Menu** key.
5. Select the required message and press the **OK** button.
6. Select **Delivery Status**.

4.3.1.4.2

Configuring Delivery Reports

Prerequisites: Ensure that your service provider enables the delivery report configuration.

Procedure:

1. From the home screen, press the **Menu** key.
2. Select **Messages** → **New Message**.
3. Press **Menu** key and select **Delivery Report**.
4. Depending on the report option that you want to use, select one of the following options:



Option	Description
None	No delivery reports are required.
Received	Delivery reports are required when the recipient receives your messages.
Consumed	Delivery reports are required when the recipient reads your messages.
Both	Delivery reports are required when the recipient receives and reads your messages.







4.3.2

Inbox

The inbox folder contains up to 100 new or old incoming messages, depending on the length of the messages. The **Messages** sub-menu indicates the number of the messages. For example, if the indication is 2/4, it means that two unread and four read messages are in the inbox.

Table 17: Inbox Icons

Icon	Description
	Unread (New) Message
	Read (Old) Message

Icon	Description
	Unread (New) Protected Message
	Read (Old) Protected Message
	Protected Message
	Sender Information in Message View – name or number
	Time and Date Stamp in Message View – arrival time and date
	Delivery Status Received – delivery status for Store and Forward messages

4.3.2.1

Receiving New Messages

When you receive a new message, your radio displays the New Message icon, an animation, and plays a tone to indicate the new message.

Procedure:

Select one of the following options:

Option	Description
Read	To read the whole message.
Back	To dismiss the message.

 **NOTE:** If you dismiss the message, you can access the message later from the inbox.

4.3.2.2

Opening the Inbox

Procedure:

1. From the home screen, press the **Menu** key.
2. Select **Messages** → **Inbox**.

The radio displays the status of the inbox for a few seconds (if any):

- No New or Old Messages
- Inbox Full



4.3.2.3

Using Submenus in Inbox and Outbox

Procedure:

1. From the home screen, press the **Menu** key.
2. Select **Messages** → **Inbox** or **Outbox**.
3. Highlight the required message and press the **Menu** key.
4. Use the submenus for the following options:

Option	Actions
Saving messages as templates	<ol style="list-style-type: none"> a. Select Store. b. Change the default name of the template and press OK.
Deleting messages	<ol style="list-style-type: none"> a. Select Delete. b. To confirm, select Yes.
Deleting all messages from the inbox or outbox	<ol style="list-style-type: none"> a. Select Delete All. b. To confirm, select Yes.
Invoking the edit screen with the original message as default text, and the message originator as a recipient	<ol style="list-style-type: none"> a. Select Reply and edit the text. b. To send, perform one of the following options: <ul style="list-style-type: none"> • Select Send. • Press the PTT button. • Press the Send key. <p> NOTE: This option is only applicable for the inbox.</p>
Invoking the edit screen with previously entered text to the same recipient	<ol style="list-style-type: none"> a. Select Resend and edit the text. b. To send, perform one of the following options: <ul style="list-style-type: none"> • Select Send. • Press the PTT button. • Press the Send key.
Invoking the edit screen with an old message and sending it to a different recipient	<ol style="list-style-type: none"> a. Select Forward and edit the text. b. To send, perform one of the following options: <ul style="list-style-type: none"> • Select Send. • Press the PTT button. • Press the Send key.
Refreshing the list of messages to display new messages	Select Refresh .

Option	Actions
Displaying the date and time of the message when it is in one of the following status: <ul style="list-style-type: none">● Sent● Delivered● Read● Expired and undelivered● Expired and unread● Failed due to an unknown error	Select Delivery Status .  NOTE: This option is only applicable for the outbox.
Protecting the message from being deleted or overwritten	Select Protect .
Removing the message protection	Select Unprotect .  NOTE: Message protection is enabled in the inbox and Call Out inbox. You can only delete unprotected messages.

4.3.2.4

Embedded Number

The Embedded Number feature allows you to call a number embedded in the message in the Inbox or Outbox folder. You can also start a group call with the message sender of a talkgroup.

4.3.2.5

Storing Numbers from Messages

Prerequisites: Embedded Number feature is enabled by your service provider.

When and where to use: You can save the number of the sender or embedded number from the message to a new or existing contact.

Procedure:

1. From the home screen, press the **Menu** key.
2. Select **Messages** → **Inbox**.
3. Highlight the required message and select **Read**.
4. Press the **PTT** button.
5. Radio displays a list of the numbers (including the senders number).
6. Highlight the required number and press **Store**.
7. Highlight required contact and press **View**.

 **NOTE:** To store a number for a new contact, select **[New Contact]** and fill out the required fields. Press **Done** to save it.

8. Select **Edit**.
9. Choose the **Type** of the new number and press **Done**.

4.3.2.6

Calling Numbers from Messages

The Embedded Number feature is enabled by your service provider. You can return a voice call to the sender of a message or to any number that is embedded in the message text.

Procedure:

1. From the home screen, press the **Menu** key.
2. Select **Messages** → **Inbox**.
3. Highlight the required message and select **Read**.
4. Press the **PTT** button.
The radio displays a list of numbers, including the number of the sender.
5. To call, select the required number and do one of the following:
 - Press the **PTT** button.
 - Press the **Send** key.
6. Press **Ctype** to select one of the following type of calls:
 - **Private**
 - **Phone**
 - **PABX**
7. Do one of the following to initiate the call:
 - Press the **PTT** button.
 - Press the **Send** key.

4.3.2.7

Making Group Calls on the Talkgroup of the Message Sender

The Embedded Number feature is enabled by your service provider.

Procedure:

1. From the home screen, press the **Menu** key.
2. Select **Messages** → **Inbox**.
3. Select the required message and press the **PTT** button.

4.3.2.8

Immediate Text Message



NOTE: This is a Software Selling Feature.

When you receive a new immediate text message, the radio plays the *New Mail Received* tone.

All immediate text messages are stored in the **Inbox** folder. If the radio is in the PIN Lock state, immediate text message is displayed after you enter the correct PIN.

The message remains on the screen until you press the **End/Home** key.

Enhanced Immediate Text Message

 **NOTE:** This is a Software Selling Feature.

When receiving immediate text message, the Enhanced Immediate Text Messaging feature prioritize displaying private call, group call, change of talkgroups, or change of volume before displaying immediate text message.

Upon receiving the immediate text message, you can perform the following action:

- Send group status message through OTB.
- Initiate Private Call through OTB.
- Select group using the rotary knob.
- Adjust the volume level using the rotary knob.











When you perform an action using OTB, your radio displays a notification on the selected action. If the OTB function is not supported while in immediate text message, your radio displays *Service Restricted*.

4.3.3

Outbox

The outbox stores up to 100 sent messages that are arranged chronologically.

Table 18: Outbox Icons

Icon	Description
	Delivery in Progress
	Delivery Accomplished
	Delivery Failed
	Successful Outgoing Message
	Failed Outgoing Message
	Protected Message Delivery in Progress
	Protected Message Delivery Accomplished
	Protected Message Delivery Failed
	Successful Outgoing Protected Message
	Failed Outgoing Protected Message

4.3.4

Call-Out (CO) Box

CO Box contains incoming and outgoing Call-Out messages.







Clicking **Select** on a Call-Out message headline displays more detailed information on the item.

When the radio is in normal mode, you are able to browse through all messages in the **CO Box**. However, if the radio is in the Call-Out mode, you can only browse through the information regarding the currently ongoing Call-Out message.

4.3.4.1

Call-Out Icons

Table 19: Call-Out Icons

Icon	Description
	Read (Old) Call-Out Message in Inbox
	Unread (New) Call-Out Message in Inbox
	Read (Old) Protected Call-Out Message in Inbox
	Unread (New) Protected Call-Out Message in Inbox
	Read (Old) Call-Out Message in Outbox
	Read (Old) Protected Call-Out Message in Outbox

4.3.5

Radio Messaging System (RMS) Box

RMS Box stores all incoming and outgoing Radio Messaging System (RMS) messages, both Status messages and Free Text messages.

4.3.6

Wireless Application Protocol (WAP) Box

Each WAP Push message can be loaded immediately or stored as a message in **WAP Box**. This feature is not supported from MR2022.2 onwards.

To access the **WAP Box**, press **Menu** and select **Messages** → **WAP Box**. All the WAP Push messages are passed to the browser.

4.3.7

Templates

A template box stores user-defined message templates.

Each message in **Inbox** and **Outbox** can be stored as a template. The name of the template and the text can be edited later.

4.3.7.1

Sending User-Defined Templates

Procedure:

1. From the home screen, press the **Menu** key.
2. Select **Messages** → **Templates**.
3. Highlight the required template name and press **Send**.
4. Send the message by using one of the following options:

Option	Actions
Sending the message to a talkgroup	Select the required talkgroup from the Talk-Group List .
Sending the message to an address in your contact list	<ol style="list-style-type: none">a. Press abc.b. Select the name of the recipient.
Sending the message to a contact or talkgroup that is not configured in the radio	<ol style="list-style-type: none">a. Enter the contact number.b. Press Send.

4.3.7.2

Managing User-Defined Templates

Procedure:

1. From the home screen, press the **Menu** key.
2. Select **Messages** → **Templates**.
3. Highlight the required template and press **Menu**.
4. Manage the templates by using the following options:

Option	Actions
Viewing the template	Select View .
Deleting the template	Select Delete .
Editing the template	<ol style="list-style-type: none">a. Select Edit Text.b. Edit the text.c. Depending on the requirement, press the Menu key and do one of the following:<ul style="list-style-type: none">• To save the edited template, select Save Changes.• To save the edited template as a new template, select Store.

Option	Actions
Editing the name of the template	<ol style="list-style-type: none">a. Select Edit Name.b. Edit the template name and press OK.

4.3.8

Predefined Templates

Predefined message templates are programmed into your radio.

You are allowed to perform limited edit operations on the predefined template. You can send it, but you cannot store the edited template or erase it from the predefined template list.

4.3.8.1

Viewing Predefined Templates

Procedure:

1. From the home screen, press the **Menu** key.
2. Select **Messages** → **Predefined**.
3. Highlight the required template and press **Menu** key.
4. Select **View**.

4.3.8.2

Sending Predefined Templates

Procedure:

1. From the home screen, press the **Menu** key.
2. Select **Messages** → **Predefined**.
3. Highlight the required template and do one of the following:
 - Select **Send**
 - Press the **PTT** button
 - Press the **Send** key

You can edit the predefined template before you send it. Press the **Menu** key and select **Edit**. The edit screen opens with the template text. You are only allowed to replace the existing text.

4.3.9

Status Messages

The radio allows you to send two types of status messages: statuses and targeted statuses. Your service provider determines which type is enabled on the radio.

Statuses can be sent either to a selected talkgroup or to a private number programmed by your service provider. Targeted statuses can be sent to any talkgroup defined for the radio or to any private number that is from the contact list or entered manually.

4.3.9.1

Viewing a Status Message Number

Procedure:

1. From the home screen, press the **Menu** key.
2. Select **Messages** → **Send Status**.
3. Press the **Menu** key and select **View**.

4.3.9.2

Sending Status Messages

You can send status messages to either a selected talkgroup or a programmed private number. Only one option can be enabled at a time.

Prerequisites:

- If sending statuses to talkgroups is enabled, switch to the talkgroup to which you want to send a status message.
- If sending statuses to private numbers is enabled, no action is needed. The private number is set up by your service provider.

Procedure:

1. From the home screen, press the **Menu** key.
2. Select **Messages** → **Send Status**.
3. Send status messages by performing one of the following options:

Option	Actions
Sending existing status messages	<ol style="list-style-type: none">a. Select the required status message.b. Perform one of the following actions:<ul style="list-style-type: none">• Press Select.• Press the PTT button.• Press the Send key.
Sending new status messages	<ol style="list-style-type: none">a. Enter a 5-digit status message number.b. Press Send.

4.3.9.3

Targeted Status Messages

The Targeted Status Messages feature enables sending status messages to addresses that can be selected by the user.

By default, targeted status messages can be sent to private or talkgroup addresses.

Your service provider can restrict valid addresses to numbers stored in **Contacts**.



NOTE: This feature is not supported on Dimetra networks.

4.3.9.3.1

Sending Targeted Status Messages

Procedure:

1. From the home screen, press the **Menu** key.
2. Select **Messages** → **Send Status**.
3. Perform one of the following actions:
 - Highlight the required status message and press the **Send** key.
 - If the status list is empty, enter a 5-digit status message number and press **Send**.
4. Do one of the following:
 - Enter the number or press **abc** to select the name from your contact list. Press **Send**.
 - Select the required talkgroup from the **TalkGroup List**.

Result: The display shows one of the following delivery reports:

- Status Sent
- Status Failed

4.3.10

Sending an RMS Status

Prerequisites: This feature is only available when enabled by your service provider. See [Radio Messaging System \(RMS\) on page 137](#) for details.

Procedure:

1. Use one of the following options:

Option	Actions
The radio is in RMS mode	Go to step 2 .
The radio is not in the RMS mode	<ol style="list-style-type: none"> a. Perform one of the following actions: <ul style="list-style-type: none"> • From the home screen, press Menu → Messages → Send RMS/FMS. • Press and hold the One Touch Button configured to display the Send RMS/FMS menu. • Use a menu shortcut assigned to the Send RMS/FMS menu. b. Go to step 2.

 **NOTE:** The navigation through the radio menu is only available if your service provider enabled the **Send RMS/FMS** menu item. However, your service provider can configure a One Touch Button to display the **Send RMS/FMS** menu even if the navigation is not possible. If the radio is not in RMS Mode, and the **Send RMS/FMS** menu item is disabled, and no One Touch Button is configured to display the **Send RMS/FMS** menu, then the radio can only receive RMS messages but cannot send them.

2. Perform one of the following actions:
 - Press and hold a required key (for RMS status 0–9).

- Press the required two keys combination (for RMS status 10–99).
- Scroll to the required RMS status.
- Type out a message using RMS Free Text (available in SDS-TL only).

4.3.11

Additional Address

The Additional Address feature allows the radio to send Radio Messaging System (RMS) messages and Local Information Protocol (LIP) reports to additionally defined recipients.

The default addresses for the RMS messages and LIP reports are defined by your service provider. RMS messages and LIP reports are also sent to selected and enabled additional address.

You can create, edit, and delete additional addresses using the radio menu. For service provider-configured additional addresses, your service provider can disable the editing and deletion of the additional addresses.

You can define up to 30 additional addresses.

4.3.11.1

Enabling or Disabling Additional Address

Procedure:

1. From the home screen, press the **Menu** key.
2. Select **Messages** → **Additional Address** → **Enable**.
3. Select one of the following options:
 - To activate the feature, select **On**.
 - To deactivate the feature, select **Off**.

4.3.11.2

Selecting Additional Address

Procedure:

1. From the home screen, press the **Menu** key.
2. Select **Messages** → **Additional Address** → **Select Address**.
The radio displays a list of aliases.
3. Highlight your alias and press **Select**.

4.3.11.3

Viewing Additional Address

Procedure:

1. From the home screen, press the **Menu** key.
2. Select **Messages** → **Additional Address** → **Select Address**.
3. Scroll to select the alias of the Additional Address you wish view.
4. Press the **Menu** key.
5. Select one of the following options:

- **Edit** (for User Defined Additional Address alias)
- **View** (for Pre-defined Additional Address alias)

Result: The display shows the Alias, the ISSI/ITSI/GSSI and the Status of the address (Pre-Defined or User Defined).

4.3.11.4

Entering New Additional Address

Procedure:

1. From the home screen, press the **Menu** key.
2. Select **Messages** → **Additional Address** → **Select Address**.
3. Select **[New Address]**
4. Press **Change** key.
5. Enter new values of the Alias and ISSI/ITSI/GSSI fields, press **Done** key.

Result: The new alias appears in the list of available aliases. There is no possibility to have two Additional Address items with the same Additional Address Alias.

4.3.11.5

Editing Additional Address

Prerequisites: Editing Additional Address is allowed only for User-Defined positions. Pre-Defined positions can only be Selected or Viewed.

Procedure:

1. From the home screen, press the **Menu** key.
2. Select **Messages** → **Additional Address** → **Select Address**.
3. Highlight the alias.
4. Press **Menu** key.
5. Select **Edit**.
6. Press **Change**.
7. Enter new values of the Alias and ISSI/ITSI/GSSI fields, press **Done** key.

Result: The changed alias appears in the list of available aliases. There is no possibility to have two Additional Address items with the same Additional Address Alias.

4.3.11.6

Deleting Additional Address

Prerequisites: Deleting Additional Address is allowed only for User-Defined positions. Pre-Defined positions can only be Selected and Viewed.

Procedure:

1. From the home screen, press the **Menu** key.
2. Select **Messages** → **Additional Address** → **Select Address**.
3. Scroll to select the alias of the Additional Address you wish delete.
4. Press the **Menu** key.

5. Select **Delete** and confirm deletion by the **OK** key.

4.3.12

Call-Out Availability



NOTE: This feature is only available when enabled by your service provider.

This menu item enables or disables the Call-Out availability.

4.3.12.1

Setting Call-Out Availability

Procedure:

1. From the home screen, press the **Menu** key.
2. Select **Messages** → **Call-Out Availability**.
3. Select one of the following options:
 - **Available**
 - **Not available**

4.4

Contacts

This menu stores all your contact numbers.

Each contact entry requires the following information:







Name

If you store more than one number to one contact, this entry is required.

Type

Each contact must be assigned to one of the following types:

Table 20: Contact Types

Contact Icon	Description
	Private Cannot have a speed dial number.
	Mobile
	Home
	Work
	PABX
	Other
	Pickers

Contact Icon	Description
	Indicate more than one number in a contact.

(number)

Each contact entry must contain a number.

Speed

Shows the default Speed Dial number. You can accept or change it.

Simplex (Private only)

Shows the hook method for simplex calls.

Duplex (Private only)

Shows the hook method for duplex calls.

4.4.1

Creating Contacts

Procedure:

1. From the home screen, press the **Contacts** key.
2. Select **[New Contact]**.
3. Highlight **Name** and press **Change**.
4. Enter your name and press **OK**.
5. Highlight **Type** and press **Change**.
6. Select the required type of contact.



NOTE:

You can also use the **Left** and **Right** Navigation keys to select the type of contact.

If **Private** is selected, you can set the hook method for **Simplex** and **Duplex** calls (if the respective Private Call Hook Customization is enabled).

7. Highlight **# (number)** and press **Change**.
8. Enter the number of your contact and press **OK**.
9. Highlight **Speed #** and press **Change**, if needed.
10. Enter the speed dial number (1–1000) and press **OK**.



NOTE: If the entered number exist, your radio displays *Overwrite?*. Press **Yes** to confirm, or **No** to enter the speed dial number again.

11. Press **Done**.

Result: You have created a contact with one number. To add more numbers, repeat steps [step 5–step 10](#).

4.4.2

Editing Contacts

Procedure:

1. From the home screen, press **Contacts** key.
2. Select the contact that you want to edit.
3. Press the **Menu** key.
4. Press **Edit**.

5. To edit, select one of the following entries and press **Change**:

- **Name**
- **Type**
- **# (number)**
- **Speed #**
- **Simplex**
- **Duplex**



NOTE: **Simplex** and **Duplex** options are only available if the contact **Type** is Private and the respective Private Call Hook Customization is enabled.

6. Press **Done**.

4.4.3

Deleting Numbers

Procedure:

1. From the home screen, press **Contacts** key.
2. Select a contact you want to edit.
3. Use **Left** or **Right** Navigation keys to choose the required number.
4. Press **Menu**.
5. Select **Delete number**.



NOTE: If an entry contains only one number, deleting the number deletes the entry.

6. Press **Yes**.

4.4.4

Deleting Contacts

Procedure:

1. From the home screen, press **Contacts** key.
2. Highlight a contact you want to delete.
3. Press the **Menu** key.
4. Select **Delete contact**.
5. Select **Yes**.

4.4.5

Checking Capacity

Checking Capacity allows you to see how many numbers are stored in your radio.

Procedure:

1. From the home screen, press **Contacts** key.
2. Press the **Menu** key.
3. Select **Capacity**.

4. Select one of the following options:

- **Private**
- **Phone/PABX**
- **Contact**

4.4.6

Dialing Through the Contact List

Procedure:

1. From the home screen, press **Contacts** key.
2. To highlight the required contact, use **Up** and **Down** Navigation keys, or enter up to 12 characters of the contact name.
3. If the contact has more than one number, use **Left** and **Right** Navigation keys to select the required number.
4. To initiate a simplex call, press the **PTT** button with a **Private** number. Otherwise use the **Send** key to initiate a duplex call.

4.5

Browser

This menu item activates a WAP browser that allows you to browse the Internet from your radio. See [Wireless Application Protocol \(WAP\) on page 141](#). This feature is not supported from MR2022.2 onwards.

4.6

Security

Security menu stores all your security settings.

4.6.1

PIN Protect

This feature allows you to enable/disable PIN code authentication at the next power on. This code protects your radio against unauthorized use.



NOTE: Customers are strongly advised to change the default PIN code in order to protect devices from unauthorized access.

If you are unable to unlock the radio, you can only send or receive Emergency Calls and adjust the volume level with the **Rotary Knob**.



NOTE: If the radio uses a BSI PIN code and you are unable to unlock the radio, you cannot take any action.

4.6.1.1

Protecting the Radio with a PIN Code

Procedure:

1. From the home screen, press the **Menu** key.
2. Select **Security** → **PIN Protect**.

3. Select **On**.
4. Enter the PIN code.



NOTE:

To increase security, set your own PIN code. By default the PIN code are all zeros (depending on the length of the PIN code). For radios with general PIN authentication, the PIN length is a fixed 4-digit code. For radios with BSI PIN authentication, the PIN length is configurable by your service provider up to a maximum of 8-digit code.

Postrequisites: Each time you turn on the terminal, PIN code is required.

4.6.1.2

Changing PIN Codes



NOTE: This feature is only available when enabled by your service provider.

Procedure:

1. From the home screen, press the **Menu** key.
2. Select **Security** → **Change Code**.
3. Radio prompts for the `Old Code`.



NOTE:

To increase security, set your own PIN code. By default the PIN code are all zeros (depending on the length of the PIN code). For radios with general PIN authentication, the PIN length is a fixed 4-digit code. For radios with BSI PIN authentication, the PIN length is configurable by your service provider up to a maximum of 8-digit code.

4. If the entered code matches the old code, radio prompts for the new code twice.

Result: Your radio displays `Code Accepted`.

4.6.2

Setting Keypad Lock

The keypad lock/unlock can be invoked from the radio menu, or by using a predefined menu shortcut. By default, the **Power** and **Emergency** buttons are always operative when the keypad is locked.

Procedure:

1. To unlock, perform one of the following actions:
 - Press **Menu** → *.
2. To lock, press **Menu** and select **Security** → **Keylock Setup** → **Lock Keypad**.

4.6.2.1

Keypad Lock Notification

When the keypad is locked, your service provider can configure one of the following instructions:

None

No notification is displayed.

Notification Only

`Keys Locked` is displayed.

Notification and Instruction

Press Menu * to lock/unlock keypad is displayed.

4.6.2.2

Setting Automatic Keylock Delay

Procedure:

1. From the home screen, press the **Menu** key.
2. Select **Security** → **Keylock Setup** → **Delay**.
3. Use **Up** and **Down** Navigation keys to change the minutes and press **Done**.

4.6.2.3

Setting Keylock on Startup

Procedure:

1. From the home screen, press the **Menu** key.
2. Select **Security** → **Keylock Setup** → **Start Locked**.
3. Select **On** or **Off**.

4.6.3

Air Encryption





NOTE: This is a Software Selling Feature.

This menu item allows you only to view air encryption state.

Air Encryption is a feature that enables encryption of entire communication between the radio and infrastructure, which results in increased security of calls, messages, and data.

If configured by your service provider, the radio plays a sound and displays `Call & Data Not Encrypted` when encryption is on and you receive a clear call (unencrypted). This feature provides service confidentiality between you and the system.

In the TMO Mode, when Air Encryption is enabled on your radio but cannot be supported due to an infrastructure failure, the following icon appears on the display: . When encryption is not available in the DMO Mode, the radio displays: .

4.6.3.1

Viewing Air Encryption State

Procedure:

1. From the home screen, press the **Menu** key.
2. Select **Security** → **AirEncrypt**.

Your radio displays:

- `Air Encryption Is Off` – The Air Encryption is not activated.
- `Air Encryption Is On` – The Air Encryption is activated.

4.6.3.2

Deleting User Keys



IMPORTANT: The key deletion takes up to 30 seconds.

Prerequisites: Ensure that the user key deletion is enabled in the codeplug.

Procedure:

Press * → * → 0 → 0 → # → #.

Result: Encryption and/or Authentication keys are deleted. The radio enters Temporary Disable state and the service provider must manually restore it.

4.6.4

K Validity

Key (K) is a secret key the infrastructure uses to authenticate the radio in the system. It is part of the authentication that provides service confidentiality between your radio and the system.

4.6.4.1

Verifying K Validity

Procedure:

1. From the home screen, press the **Menu** key.
2. Select **Security** → **K Validity**.

Your radio displays:

- **K is Valid** – The infrastructure can authenticate your radio.
- **K is Invalid** – The infrastructure is unable to authenticate your radio. Please call your service provider to restore the key to your radio.

4.6.5

SCK (Air Interface Encryption Class 2)

Static Cipher Key (SCK) is a secret key used for the Air Interface Encryption Class 2. It may be used to encrypt calls and data in TMO and DMO.

The SCK air interface encryption provides service confidentiality between radios and infrastructure when in TMO, and between radios when in DMO. A radio is capable of being loaded with up to 32 SCKs. Specific keys are used for encrypting the air interface.

Any mismatch between radios and/or infrastructure impacts communication – only those using the same key as the transmitting party are able to decode and hear the communication.

4.6.5.1

TMO SCK

Your service provider can enable SCKs in TMO. The SCKs used in TMO are called TMSCKs.

4.6.5.1.1

Verifying TMSCK Validity

When and where to use: To ensure that the TMSCKs in the radio are valid and can be used for the air interface encryption.

Procedure:

1. From the home screen, press the **Menu** key.
2. Select **Security** → **TMSCK Validity**.

The radio displays:

- `TMSCK is Valid` – The radio can work encrypted in TMO.
- `TMSCK is Invalid` – The radio cannot work encrypted in TMO. Please contact your service provider to restore SCKs to your radio.

4.6.5.2

DMO SCK

Your service provider can enable SCKs in DMO. The SCKs used in DMO are called DMSCKs.

4.6.5.2.1

Verifying DMSCK Validity

When and where to use: To ensure that the DMSCKs in the radio are valid and can be used for the air interface encryption.

Procedure:

1. From the home screen, press the **Menu** key.
2. Select **Security** → **DMSCK Validity**.

The radio displays:

- `DMSCK is Valid` – The radio can work encrypted in DMO.
- `DMSCK is Invalid` – The radio cannot work encrypted in DMO. Please contact your service provider to restore SCKs to your radio.

4.6.5.3

Changing DMO SCK



IMPORTANT: Changing this setting may cause radios not to operate correctly.

Procedure:

1. From the home screen, press the **Menu** key.
2. Select **Security** → **DMO SCK**.
3. Press **Next**.
4. Radio displays `Change to version`.
5. Select one of the following options:
 - **Yes** – To change the key. Your radio displays `Key version changed`.

- **No** – To leave the key. Your radio displays `Code Not Changed`.

4.6.6

Covert Mode

This feature enables you to completely shut down all visible and audible alerts and notifications, making your radio unnoticeable even in a silent and dark environment.

All audio activities are suppressed to the built-in speaker and mic, and the audio is routed to and from the accessory only.

When your radio is in the Covert Mode, you cannot enter the following menu items of the Setup menu.

- **Set Volume**
- **Tones**
- **Backlight** (in Display menu item)

When the Covert Mode is turned on:

- All tones are set to **Off** (corresponding to All Tones menu entry).
- The private speaker is set to **Off**.
- The dimmer state is set to covert (this state is not selectable using the **Backlight** key.)
- The wallpaper is disabled.
- The screen saver is disabled.
- The Covert Mode color palette is activated.

Your radio turns on in the mode set before turning off. If Covert Mode is enabled before turning off, your radio turns on in Covert Mode.

When Covert Mode is turned off, all the changed settings are reverted to the previous state.

When using the Covert Mode, a low audio accessory must be connected to your radio. The correct low audio accessory is the GCAI Handset, or the older style handset connected through the junction box.

This feature can be used as a One-Touch Button.

4.6.6.1

Activating Covert Mode

Procedure:

1. From the home screen, press the **Menu** key.
2. Select **Security** → **Covert Mode**.
3. Select one of the following options:
 - **On** – All tones are set to off, and the backlight and the LED are disabled immediately. The group audio is routed to the earpiece. The radio displays `Covert Mode On`.
 - **Off** – All settings for tones, backlight and audio are restored. The radio displays `Covert Mode Off`.

4.6.7

Remote Control

There are two types of remote control, Short Data Service (SDS) Remote Control and Status Remote Control.

4.6.7.1

Status Remote Control

Status Remote Control is a feature that provides limited control of the radio, unlike Short Data Service (SDS) Remote Control.

Only one type of remote control can be active on a radio; either SDS or Status.

The following tasks can be assigned remotely to a radio:

Play loud tone until user interaction

The radio plays a loud tone as in the Man Down (henceforth known as Fall Alert) feature until you unlock the keypad (if needed) and press the appropriate soft key labeled **Exit**. The tone is played through the speaker even if an accessory is attached.

The tone is not emitted when the radio is in one of the following states:

- In a call
- Temporarily disabled
- Pseudo Off Mode
- Ambience Listening Mode
- Transmit Inhibit Mode (TXI)
- Emergency Mode
- Silent Emergency Mode
- Covert Mode

Send firmware version and TEI

The radio sends back an SDS message with its firmware version and TEI.

Send birth OPTA and TEI

The radio sends back an SDS message with its birth OPTA and TEI.



NOTE: If the sending Individual Short Subscriber Identity (ISSI) is not on the Allowed ISSIs list, the receiving radio ignores the task.

4.6.7.2

SDS Remote Control



NOTE: This is a Software Selling Feature. Only one type of remote control can be active on a radio; either SDS or Status.

SDS Remote Control is a feature that enables remote control and configuration of the radio using special SDS messages. The messages can be sent both in TMO and DMO (including the Repeater Mode) by any radio capable of controlling other radios. During the execution of the Remote Control messages, depending on your service provider settings, the radio can play a tone, vibrate, or display an appropriate icon in the status icon area.

4.6.7.3

Setting Remote Control

This procedure describes how to toggle remote control.

Procedure:

1. From the home screen, press the **Menu** key.
2. Select **Security** → **Remote Control**.

3. Select **On** to enable, or **Off** to disable remote control.

4.7

Setup

The Setup menu allows you to change the general configuration on your radio.

4.7.1

Ring Style

This sub-menu allows you to set the incoming call ring style.

4.7.1.1

Setting Ring Style

Procedure:

1. From the home screen, press the **Menu** key.
2. Select **Setup** → **Ring Style**.
3. Select one of the following options:
 - **Duplex** – To set the new ring style to all duplex calls.
 - **Simplex** – To set the new ring style to all simplex calls.
 - **DMO Simplex** – To set the new ring style to all Direct Mode Operation (DMO) simplex calls.



NOTE: Upon entry into this sub-menu, the display shows the current ring style used.

4. Scroll to the desired style and press **Select**.



NOTE: New ring style is played immediately for a few seconds. If necessary, adjust the volume level.

4.7.2

Set Volume

This menu item allows you to adjust Voice, Duplex, Simplex, Keypad, and Tones volume for the Speaker and the Earpiece.

4.7.2.1

Setting Volume

Procedure:

1. From the home screen, press the **Menu** key.
2. Select **Setup** → **Set Volume**.
3. Select **Speaker** or **Earpiece**.
4. Select one of the following options:
 - **Voice** – Sets the volume level for voice.
 - **Duplex** – Sets the volume level for duplex ringtones.
 - **Simplex** – Sets the volume level for simplex ringtones.

- **Keypad** – Sets the volume level for keypad tones.
- **Tones** – Sets the volume level for alert tones.



NOTE: If the display shows only one option **Volume**, you can adjust all of the above settings at once. You have the option to change the settings individually when the **Volume Adj. Mode** is set to **Individual**.

5. Press **Right** or **Left** Navigation key to change the value.

4.7.3

Language

This sub-menu allows you to change the language of the radio.

4.7.3.1

Setting Language

Prerequisites: The list of available languages is set by service provider.

Procedure:

1. From the home screen, press the **Menu** key.
2. Select **Setup** → **Language**.
3. Select desired language.

4.7.4

Data Setup

This menu item allows you to set up your radio to transmit and receive data from the external device.

To connect your radio accessory connector to the external device, use the PMKN4104 cable.

The external device must run an application complying with the TETRA standards.



NOTE:

- Data services are available only in TMO Mode.
- Data services are blocked in TXI Mode.

4.7.4.1

Setting Data Function

Procedure:

1. From the home screen, press the **Menu** key.
2. Select **Setup** → **Data Setup**.
3. Select one of the following options:
 - **Voice Only** – Your radio receives and transmits voice calls only.
 - **Data Only** – Your radio acts as a modem. It rejects incoming and outgoing voice calls (except for Emergency Calls), status and text messages.
 - **Voice & Data** – Your radio acts as a modem but voice calls have priority over data calls and can interrupt them.

4.7.5

Audio

This menu item allows you to adjust your radio audio settings.

4.7.5.1

Audio Profiles

An audio profile is a set of audio parameters, such as the volume of alert tones, that are configured by your service provider to fit a particular operating environment. For example, the audio parameters can be adjusted to situations when the radio operates inside a building or on a noisy street.

If programmed, the radio displays a name of a currently used audio profile (on the home screen) and/or an appropriate icon associated with the profile (in the status icon area).

Your service provider can configure a maximum of ten audio profiles.

For a detailed description of a specific audio profile, contact your service provider.

4.7.5.1.1

Setting Audio Profiles

This feature allows you to adjust the audio parameters of your radio in its current operating environment.

Procedure:

1. From the home screen, press the **Menu** key.
2. Select **Setup** → **Audio** → **Audio Profile**.
3. Select a required profile.

4.7.5.2

Volume Adjustment Mode

You can set the volume to Individual or Common. When set to Common, the audio has one setting for all items.

When set to Individual, the volume level for the following options can be set per user preference.

- Voice
- Duplex
- Simplex
- Earpiece
- Speaker
- Keypad

The Volume Control Mode is configurable using the Customer Programming Software (CPS).

4.7.5.2.1

Setting Volume Adjustment Mode

Procedure:

1. From the home screen, press the **Menu** key.
2. Select **Setup** → **Audio** → **Volume Adj. Mode**.

3. Select one of the following options:

- **Individual** – You can set Duplex, Simplex, Earpiece, Speaker, and Keypad per your preferences in **Menu** → **Setup** → **Set Volume**.
- **Common** – You can set one value for all the items in **Menu** → **Setup** → **Set Volume**.

4.7.6

Tones

This field sets the volume level for the tones set.



NOTE: The radio has two tone packs: Classic Tones (default) and New Tones. Your service provider decides which tone pack is enabled.

4.7.6.1

Keypad Tone

You can activate/deactivate keypad tone at every key press.

4.7.6.1.1

Setting Keypad Tone

Procedure:

1. From the home screen, press the **Menu** key.
2. Select **Setup** → **Tones** → **Keypad Tone**.
3. Select one of the following options:
 - **On** – Activates keypad tone.
 - **Off** – Deactivate keypad tone.

4.7.6.2

All Tones

You can activate/deactivate all tones.

4.7.6.2.1

Setting All Tones

Procedure:

1. From the home screen, press the **Menu** key.
2. Select **Setup** → **Tones** → **All Tones**.
3. Select one of the following options:
 - **On** – Activates all the tones.
 - **Off** – Deactivate all the tones.

4.7.6.3

Talk Permit

You can set a different tone upon pressing the **PTT** button.

4.7.6.3.1

Setting Talk Permit

Procedure:

1. From the home screen, press the **Menu** key.
2. Select **Setup** → **Tones** → **Talk Permit**.
3. Select one of the following options:
 - **No Tone** – No tone heard upon pressing the PTT button.
 - **Short Tone** – Short tone heard upon pressing the PTT button.
 - **Normal Tone** – Factory-default tone heard upon pressing the PTT button.

4.7.6.4

Clear to Send

You can activate/deactivate tone for the transmitting radio that the receiving radio is ready to accept the transmission.

4.7.6.4.1

Setting Clear to Send

Procedure:

1. From the home screen, press the **Menu** key.
2. Select **Setup** → **Tones** → **Clear to send**.
3. Select one of the following options:
 - **Tone On** – Activate clear to send tone.
 - **Tone Off** – Deactivates clear to send tone.

4.7.6.5

Periodic Alert

You can activate/deactivate periodic tone indication for the missed calls and the unread messages. For each notification, your radio generates an unread message tone with the amber LED color indication.

4.7.6.5.1

Setting Periodic Alert

Procedure:

1. From the home screen, press the **Menu** key.
2. Select **Setup** → **Tones** → **Periodic Alert**.
3. Select one of the following options:
 - **Alert** – Activates/deactivates periodic tone.

- **Period** – Indicates the time between each periodic tone.

4.7.6.6

D-PTT Tones

This menu item contains the settings for the Double PTT feature.

The Double PTT feature allows you to send a tone pattern (single, double, or triple) when the radio is in idle or the Group Call mode by pressing the **PTT** button twice.

After the D-PTT tone is played, you can press and hold the **PTT** button once again to get the permission to talk. Otherwise, if you press the **PTT** button while the D-PTT tone is played, it is ignored.

After the D-PTT tone is sent, keeping the **PTT** button pressed results in permission to talk.

The D-PTT tone is sent over the air but is not audible on the sending radio.

4.7.6.6.1

Setting D-PTT Tones

Procedure:

1. From the home screen, press the **Menu** key.
2. Select **Setup** → **Tones** → **D-PTT Tones**.
3. Select one of the following options:
 - **D-PTT Mode** – Activates/deactivates D-PTT tone.
 - **Tone Style**– Indicates how many times the D-PTT tone is played.

4.7.7

Display

This menu item allows you to adjust your radio display settings.

4.7.7.1

Setting Font Level

When and where to use: To increase or decrease text size so you can adjust the interface readability to existing conditions.

Procedure:

1. From the home screen, press the **Menu** key.
2. Select **Setup** → **Display** → **Font Level**.
3. Select one of the following options:
 - **1** – Default size of the text.
 - **2** – Large size of the text. Keep in mind that less text can be displayed.In some languages, the number of available font levels can be decreased.

4.7.7.2

Setting Large Idle Font

When and where to use: To enable/disable large font on the home screen.

Procedure:

1. From the home screen, press the **Menu** key.
2. Select **Setup** → **Display** → **Large Idle Font**.
3. Select **On** to enable, or **Off** to disable displaying large font on the home screen.



NOTE: Large Idle Font is not available in some languages.

4.7.7.3

Setting Extended Status Icons

Procedure:

1. From the home screen, press the **Menu** key.
2. Select **Setup** → **Display** → **Extended Status Icons**.
3. Select one of the following:
 - **Disabled** – the radio always displays icons in normal size.
 - **Idle Only** – the radio displays enlarged icons only on the home screen.
 - **Always** – the radio displays enlarged icons both on the home screen and when browsing through the radio menu.

4.7.7.4

Setting Screen Saver

Procedure:

1. From the home screen, press the **Menu** key.
2. Select **Setup** → **Display** → **Screen Saver**.
3. Select one of the following options:
 - **Activate** – To activate/deactivate this feature.
 - **Text** – To set the text on the screen saver when this feature is activated.

4.7.7.5

Setting Backlight

Procedure:

1. From the home screen, press the **Menu** key.
2. Select **Setup** → **Display** → **Backlight**.
3. Select one of the following options:
 - **Auto** – Backlight is triggered by turning on the radio, by pressing any key on the device or on the accessory that is connected to it. Also getting signal from the services like: Call-Out message, DGNA and TX timeout during priority call are going to turn on the backlight.

- **Semi Auto** – Backlight is turned on when you are switching on the radio or pressing a button assigned to the backlight feature.
- **Manual** – Backlight is toggled by pressing the **Backlight** key.

 **NOTE:** Setting the backlight intensity level by pressing the **Backlight** key changes the LED, keypad backlight, and **Emergency** button backlight intensity.

4.7.7.6

Setting Wallpaper

When and where to use: To change the look of the home screen.

Procedure:

1. From the home screen, press the **Menu** key.
2. Select **Setup** → **Display** → **Wallpaper**.
3. Select one of the following options:
 - **On** – To activate this feature.
 - **Off** – To deactivate this feature.

4.7.8

Time and Date

This sub-menu controls the displayed time and date on the home screen.

 **NOTE:** If the Home Display Text Message feature is enabled, Home Mode Display Text may cover time and date, depending on the Configurable Idle Screen settings. Infrastructure synchronizes the time and date. When not within the infrastructure signal range you can set the values manually.

4.7.8.1

Setting Time and Date on the Display

Procedure:

1. From the home screen, press the **Menu** key.
2. Select **Setup** → **Time & Date** → **Display**.
3. Select one of the following options:
 - **Time & Date** – Your radio displays time and date.
 - **Time Only** – Your radio displays time only. Format Date sub-menu is disabled.
 - **Date Only** – Your radio displays date only. Format Time sub-menu is disabled.
 - **Off** – Your radio does not display time nor date. Format menu is disabled.

4.7.8.2

Setting the Time Format

Prerequisites: If **Menu** → **Setup** → **Time & Date** → **Display** is set to **Time & Date** or **Time Only**.

Procedure:

1. From the home screen, press the **Menu** key.
2. Select **Setup** → **Time & Date** → **Format** → **Format Time**.

3. Select one of the following options:
 - **12-Hour** – Displays the time with **am** (before noon) or **pm** (after noon) indication.
 - **24-Hour** – Displays the time in 24 hour format.

4.7.8.3

Setting the Time Manually

When and where to use: If the time cannot update automatically through the infrastructure.

Procedure:

1. From the home screen, press the **Menu** key.
2. Select **Setup** → **Time & Date** → **Set** → **Set Time**.
3. Enter current time using Navigation keys or keypad.
4. Enter current time using Navigation keys.
5. Press **Done**.

4.7.8.4

Setting the Date Format

Prerequisites: If **Menu** → **Setup** → **Time & Date** → **Display** is set to **Time & Date** or **Date Only**.

Procedure:

1. From the home screen, press the **Menu** key.
2. Select **Setup** → **Time & Date** → **Format** → **Format Date**.
3. Select (D – day, M – month, Y – year):
 - **DD/MM/YY**
 - **MM/DD/YY**
 - **DD-MON-YY**
 - **YY/MM/DD**

4.7.8.5

Setting the Date Manually

When and where to use: If the date cannot update automatically through the infrastructure.

Procedure:

1. From the home screen, press the **Menu** key.
2. Select **Setup** → **Time & Date** → **Set** → **Set Date**.
3. Enter current date using Navigation keys or keypad.
4. Enter current date using Navigation keys.
5. Press **Done**.

4.7.8.6

Setting Time Offset

Procedure:

1. From the home screen, press the **Menu** key.
2. Select **Setup** → **Time & Date** → **Set** → **Time Offset**.
3. Enter time offset using Navigation keys.



NOTE: You can adjust the offset value, with 15 minute steps, up to 14 hours ahead or behind.

4. Press **Done**.

4.7.8.7

Setting Automatic Updates for the Time and Date

Procedure:

1. From the home screen, press the **Menu** key.
2. Select **Setup** → **Time & Date** → **System Update**.
3. Select one of the following options:
 - **Off** – All the infrastructure information are ignored. The radio uses internal time and offset.
 - **Time Only** – Time displayed is calculated from the offset programmed by your service provider added or subtracted from the infrastructure time.
 - **Time & Offset** – Time and offset are updated after receiving from the infrastructure.

4.7.9

Accessory (Accry) Setup

You can connect IMPRES, CORE, Other, or Secondary accessories to the radio side connector.

If you connect an IMPRES accessory, the radio detects and recognizes the accessory automatically. If you connect a CORE, Other (for example, a third-party accessory), or Secondary accessory (for example, an earpiece connected to an RSM), the radio may detect the connection but manual selection is required at the **Accry Setup** menu.



NOTE: The Rear Accessory Connector on mobile radios does not detect accessories even though it is an IMPRES accessory. Therefore, select the connected accessory from the **Transceiver Accry** submenu.

The **Accry Setup** menu contains the supported accessories, represented by their Model Number as defined by the related Audio Device Descriptor (ADD). ADD is a set of parameters in the radio that defines the audio settings, such as gains and filters settings, for each accessory.



IMPORTANT: Do not connect RSMs to both connectors at the same time. To ensure correct connection, do not press any RSM buttons when connecting the RSM to the radio.

4.7.10

Active Accessory (Accry) Type

This menu item allows you to choose which of the accessory selection mode is active.

4.7.10.1

Selecting the Active Accessory (Accry) Type

When and where to use: Use this menu item to determine which microphone has priority during Alternating Hot Microphone or Ambience Listening.

Procedure:

1. From the home screen, press the **Menu** key.
2. Select **Setup** → **Active Accessory Type**.
3. Select one of the following options:
 - **Control Head Accry** – Higher priority is given to the microphone connected to the control head.
 - **Transceiver Accry** – Higher priority is given to the microphone connected to the transceiver.
 - **Control Head Accry** – Higher priority is given to the microphone connected to the control head. Applicable to RECH.
 - **Transceiver Accry** – Higher priority is given to the microphone connected to the transceiver. Applicable to RECH.
 - **Front Accry** – Higher priority is given to the microphone connected to the front accessory connector. Applicable to TSCH.
 - **Rear Accry** – Higher priority is given to the microphone connected to the rear accessory connector. Applicable to TSCH.



NOTE: In case the **PTT** on any connected accessory is pressed, the highest priority is assigned to that accessory.

4.7.11

Volume Control (Cntrl)

This menu item allows you to determine which audio output device, speaker or earpiece, is being adjusted when you turn the **Rotary Knob**.

4.7.11.1

Setting Volume Control (Cntrl)

Procedure:

1. From the home screen, press the **Menu** key.
2. Select **Setup** → **Volume Cntrl**.
3. Select one of the following options:
 - **Earpiece** – By turning the **Rotary Knob** you control earpiece volume.
 - **Speaker** – By turning the **Rotary Knob** you control the speaker volume.

4.7.12

Accessory (Accry) Setup

This menu item allows you to manually configure audio accessories that do not install automatically after plugging them in. Accessories intended for the control head and the transceiver differ and are configured separately.



NOTE: One control head can support only one external speaker at the same time, either a speaker connected to the control head, or to the transceiver. When you select one external speaker, the other becomes unselectable from the menu.

4.7.12.1

Configuring Control Head Accessories

When and where to use: Use this menu item to configure audio accessories for the control head.

Procedure:

1. From the home screen, press the **Menu** key.
2. Select **Setup** → **Accry Setup** → **CH Accry**.
3. Select one of the following options:
 - **GCAI Fronthead** – Contains a list of preconfigured accessories that can be connected to the front connector on the RECH.
 - **Secondary Accry** – Contains a list of preconfigured accessories that can be connected to Hearer Speaker Microphone (HSM).
 - **GCAI Backhead** – Contains a list of preconfigured accessories that can be connected to the back connector on the RECH.
 - **Visor Mic Backhead** – Contains a list of preconfigured visor microphones that can be connected to the back connector on the RECH.
 - **Ext Speaker Backhead** – Contains a list of preconfigured external speakers that can be connected to the back connector on the RECH.
 - **Second Mic Cradle** – Contains a list of preconfigured microphones that can be connected to the TSCH cradle.
 - **Ext Speaker Cradle** – Contains a list of preconfigured speakers that can be connected to the TSCH cradle.



NOTE: Lists of accessories are configured by your service provider.

4.7.12.2

Configuring Transceiver Accessories

When and where to use: Use this menu item to configure audio accessories for the transceiver.

Procedure:

1. From the home screen, press the **Menu** key.
2. Select **Setup** → **Accry Setup** → **Transceiver Accry**.
3. Select one of the following options:
 - **Visor Mic Rear Accry** – Contains a list of preconfigured visor microphones.
 - **Handset Rear Accry** – Contains a list of preconfigured handsets.

- **Fist Mic Rear Accry** – Contains a list of preconfigured fist microphones.
- **Ext Spkr Rear Accry** – Contains a list of preconfigured external speakers.

All accessories from the above lists must be connected to the connector at the rear of the transceiver.



NOTE: Lists of accessories are configured by your service provider. Lists that do not contain any accessory do not appear in the menu structure.

4.7.13

Book On

This menu item allows you to edit RUA/RUI feature settings to automatically accept or reject book on requests.

4.7.13.1

Editing Book On Settings

Procedure:

1. From the home screen, press the **Menu** key.
2. Select **Setup** → **Book on Setup**.
3. Select one of the following options:
 - **Book on Accept** – Radio accepts all the book on requests.
 - **Book on Reject** – Radio rejects all the book on requests without any notification.

4.7.14

Rotary Knob

This menu item allows you to set all the related functionality of the **Rotary Knob**.

4.7.14.1

Setting Rotary Knob Mode

Procedure:

1. From the home screen, press the **Menu** key.
2. Select **Setup** → **Rotary Knob** → **Rotary Mode**.
3. Select one of the following options:
 - **Dual** – Both modes are available. Turn the **Rotary Knob** to adjust the volume or press and then turn to switch to a different talkgroup.
 - **Volume** – The knob is used only as a volume control. Turn it clockwise to increase the audio volume level.

- **Scroll** – The knob is used only to change the talkgroup, or in the menu to scroll menu items.



NOTE: If you choose **Scroll** and the display shows:

- **Scroll Selected** – To adjust volume level go to the main menu, select **Setup** → **Set Volume**.
- **Function Keys are set to Adjust Volume** – You can use your **Programmable Side** buttons to adjust volume.



NOTE: The **Rotary Knob** and the **Side** buttons are paired. When the **Rotary Knob** mode is set to **Volume** or **Dual**, the **Side** buttons support the One-Touch Button feature.

4.7.14.2

Setting Rotary Lock

Procedure:

1. From the home screen, press the **Menu** key.
2. Select **Setup** → **Rotary Knob** → **Rotary Lock**.
3. Select one of the following options:
 - **Locked** – Locks **Rotary Knob**, you can unlock it by selecting **Unlocked** or by pressing and holding **Rotary Knob**.
 - **Unlocked** – Unlocks the **Rotary Knob**.
 - **Disabled** – Locking function is unavailable. Your **Rotary Knob** is unlocked all the time.

4.7.14.3

Setting In Keypad Lock

When and where to use: To set behavior of the rotary knob when the keypad is locked.

Procedure:

1. From the home screen, press the **Menu** key.
2. Select **Setup** → **Rotary Knob** → **In Keypad Lock**.
3. Select one of the following options:
 - **Lock None** – Scrolling and volume setting functionality is available.
 - **Lock Volume** – **Rotary Knob** can be only used for scrolling.
 - **Lock Scroll** – **Rotary Knob** can be only used for setting the volume.
 - **Lock Both** – Scrolling and volume setting functionality is unavailable.

4.7.14.4

Setting Rotary Knob Wrap Around

Procedure:

1. From the home screen, press the **Menu** key.
2. Select **Setup** → **Rotary Knob** → **Wrap Around**.
3. Select one of the following options:
 - **On** – Scrolling through the talkgroup list is looped or is moved to the next folder.

- **Off** – Scrolling through the talkgroup list stops after reaching first or last talkgroup in the current selected folder.



NOTE: Only when **Wrap Around** is set to **On** and the **Scroll Range** is set to **Scroll To Next**, you are able to scroll through all the talkgroups and folders.

4.7.14.5

Setting Rotary Knob Scroll Range

Procedure:

1. From the home screen, press the **Menu** key.
2. Select **Setup** → **Rotary Knob** → **Scroll Range**.
3. Select one of the following options:
 - **Stay In Range** – Scrolling through the talkgroups in the current folder only.
 - **Scroll To Next** – Scrolling through all the talkgroups and folders.



NOTE: Only when **Wrap Around** is set to **On** and the **Scroll Range** is set to **Scroll To Next**, you are able to scroll through all the talkgroups and folders.

4.7.14.6

Setting Rotary Knob Talkgroup Selection

Procedure:

1. From the home screen, press the **Menu** key.
2. Select **Setup** → **Rotary Knob** → **Confirm TG Sel..**
3. Select one of the following options:
 - **On** – You need to confirm the talkgroup selection by pressing **Select** or pressing the **PTT** button to immediately start a call on a new talkgroup.
 - **Off** – Attaches to the selected talkgroup without any additional prompt.

4.7.15

Default Setting

This sub-menu item resets the radio back to default settings.

4.7.15.1

Selecting Default Setting

Procedure:

1. From the home screen, press the **Menu** key.
2. Select **Setup** → **Def. Settings**.

Your radio display `Reset to def. settings?`. Press **Yes** to confirm.

4.8

Group Setup

This menu item allows you to set the operation parameters, scanning and my groups folder.

4.8.1

Setting Operations Parameters

When and where to use: If you want to define the radio mode and the talkgroup at the radio startup, and when changing modes TMO → DMO and TMO → Repeater.

Procedure:

1. From the home screen, press the **Menu** key.
2. Select **Group Setup** → **Operations Parameters**.
3. Select **Startup**. Select one of the following options:
 - **TMO** – The radio powers up in TMO mode.
 - **DMO** – The radio powers up in DMO mode.
 - **Last Selected** – The radio powers up in the mode it was in when last powered down.
4. Select **Home Group Startup**. Select one of the following options:
 - **Last Selected** – The radio enters the TMO/DMO talkgroup which was last selected before power down.
 - **Home Group** – The radio enters the Home Group (TMO or DMO) at power up, depending on the radio mode entered at power up.
5. Select **HGr TMO** → **DMO/Rep**. Select one of the following options:
 - **Last Selected** – When changing modes the radio enters the DMO Talkgroup last selected, for example the DMO Talk Group active last time the Radio was in DMO Mode. If Group Mappings are configured, they will take precedence and the DMO Talkgroup mapped to the current TMO Talkgroup is used.
 - **Group Mappings** – When changing modes the radio enters the DMO Home Group unless a Group Mapping is configured. If Group Mappings are configured, they will take precedence and the DMO Talkgroup mapped to the current TMO Talkgroup is used.
 - **Home Group** – When changing modes the radio enters the DMO Home Group, ignoring possible group mappings.
6. Select **TMO Home Group** to configure the TMO Home Group/Home Folder.
7. Select **DMO Home Group** to configure the DMO Home Group.

4.8.1.1

Standard Home Group

This menu item allows you to configure the standard home group to be used during start up and when changing modes: TMO → DMO and TMO → Repeater.

4.8.2

Scan

This menu item allows you to activate/deactivate scanning, view the active scan list, and edit the scan lists. This feature is available only for the TMO Mode. Your radio joins any group call as long as this group is defined in the scan list and scan is turned on.

4.8.2.1

Activating Talkgroup Scanning

When and where to use: If you want to monitor any TMO Group Call in the defined talkgroup list.

Procedure:

1. From the home screen, press the **Menu** key.
2. Select **Group Setup** → **Scan** → **Scanning**.
3. Select **Select List** and then a list name.
Your radio displays list name selected.
4. Select **Scanning** → **On**.

Result: Your radio is scanning on the predefined scan list.

4.8.2.2

Setting Talkgroups in the Active Scan List

When and where to use: If you want to edit talkgroups in the active scan list.

Procedure:

1. From the home screen, press the **Menu** key.
2. Select **Group Setup** → **Scan** → **Active List**.
 **NOTE:** If **Scanning is Off** is displayed, go to **Group Setup** → **Scan** → **Scanning** → **On** to enable scanning.
3. Select **View** and highlight the required talkgroup.
4. Press **Menu**.
5. Select one of the following options:
 - **Delete** – Erases this group from the active scan list.
 - **Priority** and select new priority to **Low**, **Medium** or **High**.

4.8.2.3

Setting Scan Lists

When and where to use: If you want to set up any scan list.

Procedure:

1. From the home screen, press the **Menu** key.
2. Select **Group Setup** → **Scan** → **Scan Lists**.
3. Highlight required scan list and press **Menu** to see additional settings:
 - **Rename** – Enters new name for that scan list.

- **Capacity** – Displays the number of assigned and unassigned talkgroups for the scan list.
- **Clear** – Deletes all the talkgroup assigned to that scan list.
- **Add Group** – Adds a talkgroup to the scan list. Select one talkgroup from your talkgroup folders and assign appropriate priority.
- **Edit** – Changes the priority of the required talkgroup or deletes it.

4.8.2.4

Deleting Talkgroups from Scan Lists

Procedure:

1. From the home screen, press the **Menu** key.
2. Select **Group Setup** → **Scan** → **Scan Lists**.
3. Highlight the required scan list and press **Menu** → **Edit**.
4. Highlight the required talkgroup and press **Menu** → **Delete**.

4.8.3

My Groups

My Groups is equivalent to **Favorites**. Both menu items contain shortcuts to favorite talkgroups and contact numbers, and allow the same operations.

For a detailed description of the feature, see [Favorites on page 109](#).

4.8.3.1

Adding Favorite Folders

Procedure:

1. From the home screen, press the **Menu** key.
2. Select **More . . .** → **Group Setup** → **My Groups**.
3. Select **[New Folder]**.

4.8.3.2

Adding Talkgroups to Favorite Folders

Procedure:

1. From the home screen, press the **Menu** key.
2. Select **More . . .** → **Group Setup** → **My Groups**.
3. Select **<FolderName>**.
4. Select **[New Group]**.
5. Select the required talkgroup by Folder or by alphabetic search.

4.8.3.3

Deleting Talkgroup from Favorite Folders

Procedure:

1. From the home screen, press the **Menu** key.
2. Select **Group Setup** → **My Groups**.
3. Select required favorite folder.
4. To delete one talkgroup, highlight it and select **Delete**.



NOTE: To delete all the talkgroups from the folder, press **Menu** and select **Delete All**.

4.9

Individual Setup

This menu item allows you to set call settings for individual calls.

4.9.1

Gateway Mode

This sub-menu item allows you to set a forwarding address for incoming calls in Gateway mode.

4.9.1.1

Setting Forwarding Address

Prerequisites:

Enter Gateway Mode.

Procedure:

1. From the home screen, press the **Menu** key.
2. Select **Individual Setup** → **Gateway Mode** → **Forwarding Address**.
3. Enter the number where the call is to be forwarded to and press **OK**.

4.9.2

Trunked Mode

This sub-menu allows you to set call waiting and call forwarding for your radio.

4.9.2.1

Enabling or Disabling Call Waiting

This feature allows you to enable or disable Call Waiting for your radio.

Prerequisites:

Enter Trunked Mode Operation (TMO).

Procedure:

1. From the home screen, press the **Menu** key.
2. Select **Individual Setup** → **Trunked Mode** → **Call Waiting**.

3. Perform one of the following actions:
 - To enable Call Waiting, select **On**.
 - To disable Call Waiting, select **Off**.

4.9.2.2

Setting Call Forwarding

This feature allows you to enable or disable Call Forwarding for your radio. If radio is not in TMO mode, selecting call forwarding will result in an *Invalid Keypress* tone and *Service Restricted* message.

Prerequisites:

Enter Trunked Mode Operation (TMO).

Procedure:

1. From the home screen, press the **Menu** key.
2. Select **Individual Setup** → **Trunked Mode** → **Call Forwarding**.
3. Set Call Forwarding by using the following options:

Option	Actions
Enabling Call Forwarding	Select Config Sending → On .
Disabling Call Forwarding	Select Config Sending → Off .
Setting predefine condition messages	<ol style="list-style-type: none"> a. Select Config. b. Select one of the following options: <ul style="list-style-type: none"> • Always • Busy • No Answer • Not Reachable <p> NOTE: The settings in the Config sub-menu is only enabled when On is selected in Enable Config.</p>
Displaying last forward call	Select Last Result .

4.10

Favorites

Favorites contains shortcuts to frequently used talkgroups and contact numbers that are organized in favorite folders.

To quickly access favorite folders, from the home screen press the **Up** Navigation key. To scroll through items inside favorite folders, you can either use the Navigation keys or the **Rotary Knob**.

4.10.1

Adding Folders to Favorites

Favorites contain less than three favorite folders.

Procedure:

1. From the home screen, press the **Menu** key.
2. Select **Favorites** → **[New Folder]**
3. Enter a name and select **OK**.

4.10.2

Adding Contact Numbers to Favorites

Procedure:

1. From the home screen, press the **Menu** key.
2. Select **Contacts**.
3. Highlight a contact that you want to add to **Favorites** and using the **Left** or **Right** Navigation key select the required number.
4. Press the **Menu** key, and select **Add to Favorites**.
5. Select a folder that you want to add the contact number to and press **Select**.

4.10.3

Making Private Calls to Favorite Contacts

Procedure:

1. To select a contact number you want to call, from the home screen do one of the following:
 - Press the **Up** Navigation key.
 - Go to **Options** → **TG by Folder**, select the required favorite folder, and highlight the contact number.
2. Use one of the following options:

Option	Actions
Making simplex calls in TMO or DMO	<ol style="list-style-type: none">a. Press and hold the PTT button.b. Wait for the Talk Permit tone before talking.c. Release the PTT button to listen.
Making duplex calls in TMO	<ol style="list-style-type: none">a. Press the Send key to initiate the call.b. You hear a ringing tone until the called party answers the call.

3. To end the call, press the **End** key.



NOTE: If you are using the fist microphone or the telephone style handset, replace it firmly on its clip or holder when done.

4.10.4

Adding Talkgroups to Favorites

Prerequisites:

- To add a DMO talkgroup, ensure that the radio is in DMO.
- To add a TMO talkgroup, ensure that the radio is in TMO.

Procedure:

1. From the home screen, press **Options**.
2. Select one of the following options:
 - **TG by Folder** – contains talkgroups arranged by folders.
 - **TG by abc** – contains talkgroups arranged alphabetically.
3. Find and highlight a talkgroup that you want to add to **Favorites**.
4. Press the **Menu** key and select **Add to Favorites**.
5. Select a folder you want to add the talkgroup to and press **Select**.

4.10.5

Managing Folders in Favorites

Procedure:

1. From the home screen, press the **Menu** key.
2. Select **Favorites**.
3. Highlight a required folder.
4. Press the **Menu** key.
5. Select one of the following options:
 - **Rename Folder** – Changes the name of the folder. Enter a new folder name and press **OK**.
 - **Delete Folder** – Removes the selected folder from **Favorites**. Press **Yes** to confirm deletion.



NOTE: You cannot delete the last favorite folder or a folder that contains at least one non-erasable item.

4.10.6

Deleting Items from Favorites Folder

When and where to use: To delete a single contact number or a talkgroup from a favorite folder.

Procedure:

1. From the home screen, press the **Menu** key.
2. Select **Favorites**.
3. Select a folder containing the item you want to remove.
4. Highlight the item and select **Delete**.

4.10.7

Deleting All Items from Favorite Folders

When and where to use: To delete all contact numbers and talkgroups stored in a favorite folder.

Procedure:

1. From the home screen, press the **Menu** key.
2. Select **Favorites**.
3. Select a required folder.

4. Press the **Menu** key and select **Delete All**.

4.11



My Info

This sub-menu allows you to view your own private, phone, and radio info.

4.11.1

Viewing and Modifying Personal Information

Procedure:

1. From the home screen, press the **Menu** key.
2. Select **My Info**.
3. Select one of the following options:
 - **My Private Num** – Displays your radio private number.
 - **My Phone Num** – Displays your radio phone number.
 **NOTE:** To modify the displayed phone number, select **Edit**. Type the number and press **OK**.
 - **Radio Info** – Displays radio information: manufacturer, product type, ISSI, TEI, Serial Number, and OPTA.
 **NOTE:** OPTA information is optional.

4.11.2

Viewing Talkgroup Subaddresses

Procedure:

1. From the home screen, press the **Menu** key.
2. Select **My Info** → **Talkgroup Info** → **Talkgroup List** → **View Talkgroup sub-addresses**.

4.12

Recent Calls

You can view the history of all calls:

- **Dialed** – Calls you initiated.
- **Received** – Calls you answered.
- **Missed** – Calls you received but not answered or rejected.

Each list of calls may contain up to 50 numbers, the most recent call being at the top of the list. If the number of a recent call is stored in the contact list, the name associated with the number appears in the recent calls list. A number dialed more than once, appears only once in the list.

 **NOTE:** Calls missed in TXI mode are stored and can be viewed.

4.12.1

Viewing Recent Calls

Procedure:

1. From the home screen, press the **Menu** key.
2. Select **Recent Calls**.
3. Select one of the following options:
 - **Dialed**
 - **Received**
 - **Missed**
4. Select a required call from the list.
5. Press the **Menu** key.
6. Select **View**.



NOTE: Press **Down** Navigation key to bypass first two steps.

Call time information is only available if the time and date are set in the radio. Call duration is not available in the missed calls list.

4.12.2

Calling from Recent Calls

Procedure:

1. From the home screen, press the **Menu** key.
2. Select **Recent Calls**.
3. Select one of the following options:
 - **Dialed** (from the home screen press **Send** key to access **Dialed Calls** list)
 - **Received**
 - **Missed**



NOTE: From the home screen press **Down** Navigation key, to access **Recent Calls** menu item.

4. Highlight the required call and press **PTT** button for private calls or press **Send** key for phone call.



NOTE: Phone calls are only available in TMO Mode.

4.12.3

Storing Recent Calls to Contacts

Procedure:

1. From the home screen, press the **Menu** key.
2. Select **Recent Calls**.
3. Select one of the following options:
 - **Dialed**
 - **Received**

- **Missed**
4. Press **Store**.
 **NOTE:** If **Store** is not assigned to the **Left** Soft key, the number is already stored in your contact list.
 5. Perform one of the following actions:
 - To store the number as a new entry, select [**New Contact**].
 - To store the number to an existing entry, select the entry, and press **View** then select **Edit**.
 6. With the contact type field highlighted, scroll left or right to display the contact type you want to assign the number.
 7. Select **Done**.

4.12.4

Deleting Recent Calls

Procedure:

1. From the home screen, press the **Menu** key.
2. Select **Recent Calls**.
3. Select one of the following options:
 - **Dialed**
 - **Received**
 - **Missed**
4. Highlight the required call and press **Menu**.
5. Select **Delete**.



NOTE: To erase all the calls, select **Delete All**.

4.13

Shortcuts

This sub-menu allows you to set up shortcuts to access frequently used menu items.

4.13.1

Creating Menu Shortcuts

When and where to use: To assign a shortcut for the menu item.

Procedure:

1. From the home screen, press the **Menu** key.
2. Scroll to the item you want as a shortcut.
3. Press and hold **Menu** when the item is highlighted.

Example:

Creating a shortcut to the **All Tones** options.

1. From the home screen, press the **Menu** key.

2. Select **Setup** → **Tones**.
3. Highlight **All Tones** and press and hold **Menu** until `Assign Shortcut for: All Tones` is displayed.
4. Select **Yes** and `Shortcuts Key: 1` is displayed.
5. Press **Done**.



NOTE:

To use this shortcut, from the home screen, press **Menu** and the key **1**.

4.13.2

Editing Menu Shortcut Lists

Procedure:

1. From the home screen, press the **Menu** key.
2. Select **Shortcuts**.
3. Highlight a required shortcut and press **Menu**.
4. Select one of the following options:
 - **Edit** – Changes the assigned key. Type required number and press **OK**.



NOTE: Type a number between 1–20.

- **Delete** – Erases highlighted shortcut. Select **Yes** to confirm.
- **Delete All** – Erases all the shortcuts. Select **Yes** to confirm.

4.14

Radio User Identity (RUI)

This menu item allows you to log in/out to the radio.

4.14.1

Logging On

Procedure:

1. From the home screen, press the **Menu** key.
2. Select **RUI** → **Log on**.
3. Highlight:
 - **User ID** and press **Select** to enter **User ID List**. If you are a new user on this radio, select **[New User ID]** and enter your user ID. Otherwise select your user ID from the list.
 - Second line and press **Edit**, to enter user ID and press **OK**.
4. Select **User PIN**, enter your credentials, and press **OK**.
5. Logging screen is displayed.

4.14.2

Logging Off

Procedure:

1. From the home screen, press the **Menu** key.
2. Select **RUI** → **Log off**.
3. Press **Accept**.

4.15



Networks

This is a Software Selling Feature. This menu item allows you to switch between the radio operation modes.

4.15.1

Selecting Network Operation Mode

Procedure:

1. From the home screen, press the **Menu** key.
2. Select **Networks**.
3. Select one of the following options:
 - **Network Sel** – Selects the network to which the radio is allowed to register.
 - **Trunked Mode** – Switches to the mode using infrastructure.
 - **Direct Mode** – Switches to the mode without using infrastructure.
 - **Repeater Mode** – Switches to the Repeater Mode.
 - **Gateway Mode** – Switches to Gateway Mode.
 - **TXI Mode** – Select **Activate** to stop sending any radio transmission.
 -  **NOTE:** If the radio is in **TXI Mode**, it is not possible to switch from **Direct Mode** to **Trunked Mode** or **Repeater Mode**, or **Gateway Mode**.
 - **Automatic DMO** - Enable or Disable Automatic DMO.
 -  **NOTE:** When the radio enters Automatic DMO through a gateway, the radio does not support Private Calls.
 - **TG Net Sel** – Selects one or multiple networks determined by the selected talkgroup.

4.15.2

Network Select

This sub-menu item allows you to select a network to register your radio. **Network Sel** is available only in TMO or Gateway mode, otherwise your radio display *Service Restricted* message.

4.15.2.1

Selecting Your Network

Procedure:

1. From the home screen, press the **Menu** key.
2. Select **Networks** → **Network Sel** → **Home Only**.

Your radio registers to the home network.

4.15.2.2

Using Select Net Registration

Procedure:

1. From the home screen, press the **Menu** key.
2. Select **Networks** → **Network Sel** → **Select Net**.
3. Select the required network from the list.

Result: Your radio registers to the selected network.

4.15.2.3

Using Any Network Registration

When and where to use: Your radio has lost its home network coverage and wants to increase the number of networks it can scan and register.

Procedure:

1. From the home screen, press the **Menu** key.
2. Select **Networks** → **Network Sel** → **Any Network**.

Your radio selects and registers to the network automatically from the predefined list.

4.15.3

Enabling Automatic DMO

 **NOTE:** This is a Software Selling Feature.

Procedure:

1. From the home screen, press the **Menu** key.
2. Select **Networks** → **Network Sel** → **Automatic DMO** → **Enable/Disable**.

 **NOTE:**

You can enable or disable Automatic DMO in the options menu using Trunked Mode Operation (TMO), Direct Mode Operation (DMO), and Automatic DMO option keys.

Private Calls are not supported when your radio enters Automatic DMO through a gateway.

4.15.4

Talkgroup Network Select

This sub-menu item allows you to select one or multiple networks to register your radio accordingly to the selected talkgroup. **TG Net Sel** is available when the selected talkgroup is a Any Net talkgroup or a InterSystem Interface (ISI) talkgroup, otherwise your radio display *Service Restricted* message.

4.15.4.1

Selecting Your Talkgroup Network

Procedure:

1. From the home screen, press the **Menu** key.
2. Select **Networks** → **TG Net Sel** → **Home Only**.

Your talkgroup registers to the home network.

4.15.4.2

Using Select TG Net Registration

When and where to use: If the talkgroup selected is an Any Net talkgroup, this menu displays multiple networks allowed for registration. If the talkgroup selected is an ISI talkgroup, this menu displays multiple talkgroup linked networks. Use this feature to migrate to another predefined network, when you are out of the range of your network and your radio displays the *No Service* message.

Procedure:

1. From the home screen, press the **Menu** key.
2. Select **Networks** → **TG Net Sel** → **Select TG Net**.
3. Select the required network from the list.

4.15.4.3

Using Prefer TG Net Registration

When and where to use: If the talkgroup selected is an Any Net talkgroup, this menu displays multiple networks allowed for registration. If the talkgroup selected is an ISI talkgroup, this menu displays multiple talkgroup linked networks. Use this feature to select a network that is most preferred. The selected network is the first priority for scanning and registration.

Procedure:

1. From the home screen, press the **Menu** key.
2. Select **Networks** → **TG Net Sel** → **Prefer TG Net**.
3. Select the required network from the list.

4.15.4.4

Using Any TG Net Registration

When and where to use: Your radio has lost its network coverage and wants to increase the number of networks it can scan and register. If the talkgroup selected is an Any Net talkgroup, this menu displays

all networks allowed for scanning and registration. If the talkgroup selected is an ISI talkgroup, this menu displays all talkgroup linked networks allowed for scanning and registration.

Procedure:

1. From the home screen, press the **Menu** key.
2. Select **Networks** → **TG Net Sel** → **Any TG Net**.

Your radio selects and registers to the network automatically from the predefined list.

4.16

Location

 **NOTE:** This is a Software Selling Feature.

This sub-menu allows you to enable the GNSS, change GNSS accuracy, and view your position and testpage.

See [GNSS Location Service on page 130](#).

4.16.1

Enabling GNSS

Procedure:

1. From the home screen, press the **Menu** key.
2. Select **Location** → **Interface**.
3. Select **On**.

 **NOTE:** Your service provider can enable this feature.

4.16.2

Viewing Your Position

Procedure:

1. From the home screen, press the **Menu** key.
2. Select **Location** → **Position**.

4.16.3

Viewing Testpage

Procedure:

1. From the home screen, press the **Menu** key.
2. Select **Location** → **Testpage**.
3. Select one of the following options:
 - **Position** – Displays detailed information on your radio current position: time, **N** (latitude), **E** (longitude), **H** (height), **Sats Used** (a number of tracked satellites), **B** (bearing), **HS** (horizontal speed), **LC** (level of confidence).

- **Power** – Displays detailed information on a particular satellite: **PRN** code, **Status**, **Mode**, **C/N** (carrier-to-noise ratio).
- **Version** – Displays detailed information on software version: **SW** (software version), **HW** (hardware version), **ASIC** (application-specific integrated circuit), **RC** (release code).

4.16.4

Backlog

This sub-menu allows you to enable/disable, view, and delete backlog reports.



NOTE: The location report backlog is only available when Local Information Protocol (LIP) is enabled.

4.16.4.1

Enabling or Disabling Backlog

Procedure:

1. From the home screen, press the **Menu** key.
2. Select **Location** → **Backlog** → **Enablement**.
3. Select one of the following options:
 - **On** – Activates location report backlog recording.
 - **Off** – Deactivates location report backlog recording.

4.16.4.2

Viewing Backlog Reports

Procedure:

1. From the home screen, press the **Menu** key.
2. Select **Location** → **Backlog** → **Reports**.
The radio displays the number of backlog reports stored.

4.16.4.3

Deleting All Backlog Reports

Procedure:

1. From the home screen, press the **Menu** key.
2. Select **Location** → **Backlog** → **Delete All**.

4.17

Packet Data



NOTE: This is a Software Selling Feature.

The Packet Data (PD) Service allows you to transfer data in a TETRA system using the Internet Protocol (IP).



NOTE:

To transfer data from a standard computer over the air, connect the computer using the data cable PMKN4104 with your radio. Your service provider has to setup additional applications on your computer.

If set up by your service provider it is possible to accelerate the transmission by using the Multi-Slot Packet Data (MSPD) Service.

4.17.1

TETRA Enhanced Data Services (TEDS)



NOTE: TEDS is model-specific and may not be available on your radio. Contact your service provider for more information.

TETRA Enhanced Data Services (TEDS) is an enhancement of the Packet Data feature and allows for increased speed of data transfer.

When TEDS is enabled, an appropriate icon is displayed in the status icon area. The icon is visible even if an infrastructure does not support TEDS – in such a situation the data is transferred by using the standard Packet Data.

4.17.2

Viewing Data Statistics

Procedure:

1. From the home screen, press the **Menu** key.
2. Select **Packet Data**.



NOTE: Data services are only available in TMO Mode. The data option must be set to **Voice Data** or **Data Only**.

3. Select one of the following options:
 - **Sent Data** – The number of KBs sent and throughput since current Packet Data activation is displayed.
 - **Received Data** – The number of KBs received and throughput since current Packet Data activation is displayed.
 - **Bandwidth** – Active data session percentage is shown.
 - **Failed Transfer** – The percentage of failed sent/received packets.



NOTE: N.A. – Standby packet data session.

4.17.3

Viewing Encryption Status

Procedure:

1. From the home screen, press the **Menu** key.
2. Select **More . . .** → **Packet Data** → **Encryption**.
3. The encryption state of the ongoing packet data session is displayed:
 - Packet Data Channel Clear
 - Packet Data Channel Encrypted

- Encryption N/A (clear)

4.18

Crypto Menu

This sub-menu allows you to manage SIM card based End-to-End Encryption.

The End-to-End Encryption is used for:

- Encryption of voice transmission in the DMO and TMO Modes.
- Encryption of messages transmission in the TMO Mode.
- Encryption of messages transmission in the DMO Mode (the radio cannot be in call).
- Encryption of position data (GPS) transmission in the TMO and DMO Modes.
- Transfer of Operational Tactical Address (OPTA) in the TMO and DMO Modes.
- Management of encryption keys in the TMO Mode.

4.18.1

Enabling or Disabling SIM Card End-to-End Encryption

Prerequisites:

Ensure that:

- The SIM card is inserted in the radio.
- The radio is not in an active call.
- You cannot press the **PTT** button.

Procedure:

To enable or disable the SIM card End-to-End Encryption, use one of the following options:

Option	Actions
Operating the configured One-Touch Button	Press the One-Touch button.
Operating from the menu	a. Press Menu → Crypto Menu → Crypto Function . b. Select Encryption On to enable or Encryption Off to disable encryption.

Your radio displays prompts indicating your current encryption state: an appropriate status icon and the `Encryption On` or `Encryption Off` message.

4.18.2

Setting Clear Call Alarm

When and where to use: The **Clear Call Alarm** menu is used to configure an alarm tone to notify on any clear transmission.

Procedure:

1. From the home screen, press the **Menu** key.
2. Select **Crypto Menu** → **Clear Call Alarm**.

3. Select **Simplex Calls** or **Duplex Calls**.
4. Select one of the following options:
 - To disable the alarm, select **Off**.
 - To enable the alarm to ring once at the beginning of a clear call, select **Single**.
 - To enable the alarm to ring periodically throughout a clear call, select **Continuous**.

4.18.3

Updating Encryption Keys

When and where to use: The Updating Encryption Keys menu is used to update old or incorrect encryption keys.

Procedure:

1. From the home screen, press the **Menu** key.
2. Select **Crypto Menu** → **Upd Encr Keys**.
3. Select **Upd Group Key** to start the update.

 **NOTE:** You can update the encryption keys if the End-to-End Encryption is enabled. The keys cannot be updated when the radio is in a call or in Direct Mode Operation (DMO).

4.18.4

Viewing OPTA

When and where to use: The **Show OPTA** menu is used to view Operational Tactical Address (OPTA) that provides supplementary information about the organization and operational role of a radio.

Procedure:

1. From the home screen, press the **Menu** key.
2. Select **Crypto Menu** → **Show OPTA**.

4.18.5

Setting OPTA Filter

When and where to use: Use this menu item to define which characters are masked when the OPTA name is displayed.

Procedure:

1. From the home screen, press the **Menu** key.
2. Select **Crypto Menu** → **OPTA Filter**.
3. Highlight check boxes using the Navigation keys and press **Select** to set which characters are masked when the OPTA name is displayed.
4. Press **Done** to confirm the changes.

4.18.6

Starting Crypto Registration

Prerequisites: Ensure that your radio is not in an active call or in Direct Mode Operation (DMO).

Procedure:

1. From the home screen, press the **Menu** key.
2. Select **Crypto Menu** → **Crypto Registr.**
3. Select **Start Registr** to start the registration.

4.18.7

Configuring Audio Settings

The **Audio Settings** menu is used to change the audio output for a group call when the call is encrypted but the End-to-End Encryption is disabled.

Procedure:

1. From the home screen, press the **Menu** key.
2. Select **Crypto Menu** → **Audio Settings**.
3. Select **Encr Audio On** to enable or **Encr Audio Off** to mute the encrypted audio for clear mode.

4.18.8

Setting DMO Encryption Mode

Procedure:

1. From the home screen, press the **Menu** key.
2. Select **Crypto Menu** → **DMO Encr Mode**.
3. Enable the required mode by selecting one of the following options:
 - For crypto mode bit 1, select **DMO 1**.
 - For crypto mode bit 2, select **DMO 2**.

4.18.9

Setting Encryption Keys for SDS Messages

The SDS Encryption Mode menu is used to set encryption keys for group and individual SDS messages.

Procedure:

1. From the home screen, press the **Menu** key.
2. Select **Crypto Menu** → **SDS Encr Mode**.
3. Select one of the following options:
 - **Individual SDS**
 - **Group SDS**
4. Select one of the following options:
 - **Global Key**
 - **Group Key**

Chapter 5

Features

5.1

Ambience Listening (AL) Call

Ambience Listening Call allows a dispatcher to make a special call that allows listening to the conversations and background noises within the range of the microphone of a particular radio.

The call is set up without any indication to the affected radio, and any lower priority ongoing voice call or packet data transfer may be preempted.

The call is set up without any indication to the affected radio, and any lower priority ongoing voice call may be preempted.

After accepting the call, the radio transmits in a simplex call without any action from or indication to the user. The Ambience Listening Call automatically ends when you initiate any voice call, switch to Emergency or TXI Mode, or send Emergency Alarm.

5.2

Buffer Full Overwrite Policy

Upon receiving a text message, the radio places the text into a circular buffer. You are notified when a new text message is received and a quick access to read the message is provided. If a delivery report is requested, the radio sends it upon receipt of the message by SDSTL. If a consumed report is requested, the radio sends it when you read the message.



NOTE: If you read the message when the radio is out of service, the report may not be sent.

You can save incoming or edited (outgoing) text messages. These messages can be edited and sent. You can also protect the message from being deleted or from the overwriting policy of the radio.

For each message, you can verify its timestamp. The timestamp displayed is extracted from the SDS TL PDU. The timestamp is generated and inserted to the message by the SwMI.

5.3

Call-Out



NOTE: This is a Software Selling Feature.

For those who use DMO mode, you are recommended to apply DMO SCK for data confidentiality.

This feature allows you to receive Call-Out alerts. On receiving the Call-Out messages, the radio interrupts current services and attends to the Call-Out alert without any further delay. After the Call-Out is cleared by the dispatcher, the radio exits Call-Out mode and reverts to normal mode.

Your radio plays a Call-Out tone according to the configured indication profile. The indication profile is configured based on the severity level of a matching Group Short Subscriber Identity (GSSI) and Sub-Address Group Call-Out.

During Call-Out mode, you are only able to receive Emergency calls. However, if your service provider configures Emergency Calls to be ignored during Call-Out mode, the radio rejects them with no notification.

If your service provider temporarily blocked the use of PTT in the Call-Out, pressing **PTT** in the Call-Out mode is considered an invalid key press until the timer expires.

The time-stamp on the Call-Out alert indicates the time and date when the Call-Out is received.

To read an entire Call-Out message, scroll down the screen by pressing the **Down** Navigation key. The length of the message is indicated by the vertical bar on the left of the screen.

Figure 8: Call-Out Message

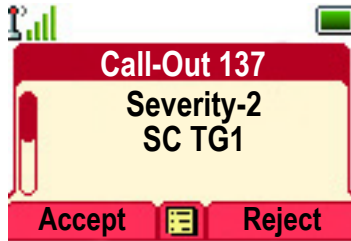

 **NOTE:** Message protection functionality is enabled in the Inbox and Call Out Inbox. Users can only delete unprotected messages.

5.3.1

Types of Call-Out Alerts

There are five types of the Call-Out alerts:

Normal Call-Out

An alert message that is sent by a dispatcher either to a single radio or to a group of radios. There are two types of Normal Call-Out:

With user receipt

The radio gets to the Accepted phase when you:

- select **Accept**, **Reject**, or **Standby**.
- the acknowledgment timer runs out.

Without user receipt

The radio gets to the Accepted phase when you:

- press **Menu** or any key except for the **Emergency** button, or the **Rotary Knob**.
- the acknowledgment timer runs out.

The Normal Call-Out mode is ended when the validity timer runs out.

Storm Plan

An alert message that is sent by a dispatcher to a group of radios. To raise its reliability, it is sent several times. You are not able to respond to the Call-Out alert and any key press takes you to the information phase.

The Call-Out mode is ended when one of the following scenarios occur:

- the acknowledgment timer runs out.
- you press any key, except for the **Emergency** button or rotary knob.
- you press the **Messages** and **Exit** softkeys.

Simple Call-Out

An alert with the functionality similar to full Call-Out but without the information phase. There are two types of Simple Call-Out:

With user receipt

The Call-Out mode is ended when the acknowledgment timer runs out, or when you select **Accept**, **Reject**, **Standby**, or reply with a text message.

Without user receipt

The Call-Out mode is ended when one of the following scenarios occur:

- the acknowledgment timer runs out.
- you press any key, except for the **Emergency** button or rotary knob.
- you press the **Messages** and **Exit** softkeys.

Fallback Mode

An alert message that is limited only to voice communication. To initiate this type of Call-Out, press a One-Touch key predefined by your service provider. It can be cleared manually.



NOTE: Fallback is only possible when the radio is in Local Site Trunking.

Test Call-Out

A special Call-Out alert that is sent by the dispatcher to test this feature. On receiving the Test Call-Out, the radio plays a tone and displays `Test Call-Out`. To respond and clear the alert, press the **Test OK** Soft key.

5.3.2

Call-Out Modes Interaction

Call-Out feature operation is different in other modes:

Transmit Inhibit (TXI) Mode

You can receive Call-Out messages. The Call-Out alert message is displayed on the screen. You have the option to exit TXI Mode or exit the Call-Out prompt.

- Exit TXI – Your radio exits TXI mode and prompts you to accept or reject the Call-Out message.
- Exit Call-Out – Your radio exits the Call-Out message and returns to TXI mode.

Trunked Mode Operation (TMO)

Call-Out is supported.

Direct Mode Operation (DMO)

Call-Out is supported.

Gateway

Call-Out is supported.



NOTE: Gateway shall stay in Gateway mode or leave Gateway mode to join Call-out is depending on the configuration.

Emergency Mode

All Call-out alerts are ignored.

5.3.3

Call-Out Service Phases

In the Call-Out mode, there are the following phases:

Alerting Phase

Alerting users by using the LED pattern, vibration pattern, alert tone and volume level configured for the first matching subaddress that contains the indication profile setting.

The radio receives a Call-Out message. An alarm tone indicates the message. When the text is displayed, you have the following options:

- **Accept**
- **Reject**
- **Menu**



NOTE: If your service provider allowed it, you can stop the alert tone by pressing any key.

Information Phase

You are still in the Call-Out mode and you can receive more detailed information about the incident that occurred through subsequent text or a voice message. You can query for more information using a voice group call or Call-Out text function, which enables you to send a text message.

Depending on the settings configured by your service provider, you are able to respond to a Call-Out by:

Free text

Type a response.

Pre-coded message

Select from a list of predefined replies.

5.4

DTMF Overdial

This feature allows you to communicate with an automated answering device (for example, the voice mail or answering machine) during an on-going private, phone or PABX call.

While in an on-going private, phone or PABX call, press the DTMF keys (0-9, *, #). When pressed, the DTMF key sounds a tone and the entered digit is displayed on the screen.

5.5

Dual Control Head

This feature allows you to use two control heads with one transceiver. The control heads are of equal importance and have almost identical functionality, the only difference is second PTT installed on the Telephone Style Control Head.

In Dual Control Head mode, when you press **Menu** → **Setup** you can choose between two control heads: **CH1** and **CH2**. Almost all menu items inside them are common for both control heads, except for: **Set Volume**, **Accry Setup**, and **Font Level** (provided that control heads are different). These menu items are configured separately for each control head.



NOTE: If this feature is enabled by your service provider, appropriate icons appear on the display.

Check with your service provider default accessory selections and your radio behavior for all types of calls as each control head can have different setup.

5.5.1

Interactions Between Control Heads

Your service provider can connect one transceiver with either one of the following options:

Two Identical Control Heads

Both control heads have identical resolution and soft-key area location. Identical screens are displayed on both control heads. Only the following can be used:

- Two IP54 Remote Ethernet Control Heads (IP54 RECH)
- Two IP67 Remote Ethernet Control Heads (IP67 RECH)
- Two Telephone Style Control Heads (TSCH)
- Mixed IP54 RECH and IP67 RECH

Two Different Control Heads

Both control heads have different resolution, soft-key area location, or both. Any combination of supported control heads can be used. The active screen is displayed on the operating control head while an idle screen is displayed on the other control head.

You can use both control heads interchangeably for the same activity (for example, writing a message). If you start an activity on one control head you can continue it on the second, provided that token is free.

Token is a right to use a key or button for a period of time. If you press a key or button on one control head, token activates on it, and no one can press anything on the second control head until token time passes. After you release the key/button, token becomes available again and can be taken over by the second control head. When token is activated, Key Press Token icon is visible on the display. By default, token time is set to 3 seconds.



NOTE: Token does not apply to **Emergency** button and **On/Off/End/Home** key. These can be pressed on both control heads at any time.

5.5.2

Dual Control Head Link

Dual Control Head Link is a connection that occurs when both control heads are properly connected to the transceiver and can communicate.

When the Dual Control Head Link is established, control heads play a tone and display Dual Control Head icon. Full functionality is available on both devices.

When one control head cannot connect to the transceiver when turning on, your radio displays Single Control Head icon and enters Single Control Head mode.

When one control head disconnects from the transceiver during operation:

- The active control head displays Link Error icon.
- The inactive control head displays Link Error and shows Link Error display (if power is available).

Turning on/off one control head results in simultaneous turning on/off the second control head.

5.5.3

Audio Accessories

Depending on a call type, voice can be routed to Control Heads and audio accessories connected to them in different ways.

During an outgoing group call, the voice can be heard either on one Control Head or on both Control Heads (depending on your service provider's settings).

During an incoming group call, the voice is always heard on both Control Heads. However, if two accessories are connected to one Control Head (to the front and the rear connector), voice is transferred through only one of them, the one with higher priority. Priority is the following (from the highest): handset (must be off-hook), HSM, external speaker.

Private calls are always transferred to the Control Head that receives a call.

Only one microphone/PTT can be opened at a time. The microphone that is pressed as first is allowed to initiate the transmission.



NOTE: The voice routing is not applicable for the Bluetooth Headset since the Bluetooth Headset is always set as the highest priority.

5.5.4

Transmission Monitor

This feature, if enabled, allows you to monitor group calls and hear ongoing voice transmission. Your service provider can configure it to work in one of the following ways:

- Call initiated on CH1 is heard on CH2.
- Call initiated on CH2 is heard on CH1.
- Call initiated on any CH is heard on both control heads.

5.5.5

Keys Interactions

If any key except **Emergency** button and **On/Off/End/Home** key are pressed on any control head, Key Press Token icon is displayed and all keys on the other control head are blocked. This behavior is called token and means the right to use a key or button for a period of time.



NOTE: Your service provider can adjust the time that the keypad is blocked on the other control head. At any time **Emergency** button and **On/Off/End/Home** key can be pressed on both control heads.

5.6

GNSS Location Service



NOTE: This is a Software Selling Feature.

The Global Navigation Satellite System (GNSS) Location Service feature uses information from GNSS satellites orbiting the Earth to determine the approximate geographical location of your radio.

The GNSS Location Service availability, accuracy, and the position calculation time vary depending on the environment in which you use the radio. The GNSS Location Service can assist your dispatcher or colleagues in many ways. For example, deploying of resources more efficiently or locating your radio when you trigger your emergency service.

The radio can display the location information directly on the screen or send it over the air to your dispatcher to display it in the control center. Check your radio configuration details with your service provider.

The radio supports the following system combinations:

- GPS
- GLONASS
- BeiDou
- GPS + GLONASS

- GPS + BeiDou



IMPORTANT:

Where the signals from satellites are not available, the GNSS Location Service does not work. This usually happens when your radio cannot establish a view of a wide area of open sky. An example would be when the GNSS antenna is covered or facing the ground. Such situations include being:

- In underground locations
- Inside buildings, trains, or other covered vehicles
- Under any other metal or concrete roof or structure
- Near a powerful radio or television tower
- In extreme temperature outside the operating limits of your radio

Even if your location information can be calculated in such situations, it may take longer to do so. Therefore, in any emergency situation, always report your location to your dispatcher. Where adequate signals from multiple satellites are available, your GNSS Location Service feature provides a location, most probably near to your actual location.

The radio can be triggered to send Location Reports in various circumstances, for example:

- Upon a request
- Entering Emergency Mode
- At specified time intervals
- At specified distance intervals



NOTE: LIP Triggers can be configured for TMO only, DMO only, or both modes at the same time.

The Location Reports can be sent both in Trunked Mode Operation (TMO) and Direct Mode Operation (DMO) by using:

- Short Data Service (SDS) messages
- Packet Data (in TMO mode only, with Packet Data enabled on the network by the service provider)

The radio can be configured to give audio-visual notifications upon sending the Location Reports.

Depending on the radio settings, viewing the radio position and the status of the visible satellites is available. The position may consist of longitude and latitude, UK, or Irish grid coordinates.

5.6.1

Enhance GNSS Performance

Sometimes the GNSS feature is unable to complete a location calculation successfully. You hear an audible tone indicating that your radio cannot see the satellites.

This feature works best where there is nothing between your radio and a large amount of open sky. To maximize the ability of your radio to determine a location fix, avoid closed space, tall buildings, and foliage. If possible, do not use this feature in underground parking lots, tunnels, under bridges, and close to high buildings.

5.6.2

Location Report Backlog

Your radio can record location track when it is out of service, when in DMO, or when in TXI mode.

The location reports generated during this time are stored, and all location report backlog recordings are uploaded once your radio is back in service. Your radio can save up to a maximum of 180 location reports. The location report backlog function differently when in different mode:

Location Backlog Recording in Trunked Mode Operation (TMO)

Your radio starts recording location reports when radio is out of service in TMO Mode.

Your radio resumes the latest location reporting when TMO coverage is regained.

Location Backlog Recording in Direct Mode Operation (DMO)

Your radio starts recording location reports in DMO Mode.

Your radio resumes the latest location reporting when it switches back to TMO mode.



NOTE: This feature is only available when enabled by your service provider.

Location Backlog Recording in Transmit Inhibit Mode (TXI)

When your radio is in TXI mode, location reports are generated and recorded but not sent out.

Once your radio exits TXI mode and is within TMO coverage, the location reports are uploaded to the server.

5.6.3

GNSS Icon

When GNSS is enabled, the following icon is displayed in the status icon area: .

Depending on the current GNSS state, the icon can be solid – GNSS has a fix, or blinking – GNSS is searching for a fix. The blinking GNSS icon can be disabled/enabled by your service provider.

5.6.4

Different Location Displays

Table 21: Different Location Displays

Latitude/Longitude	UK Coordinates	Irish Coordinates	UTM Coordinates	MGRS Coordinates
Time	Time	Time	Time	Time
Latitude	2-Letter Code	1-Letter Code	3-Letter Code	3-Letter Code and 2-Letter Code
Longitude	Easting and Northing Coordinate	Easting and Northing Coordinate	Easting and Northing Coordinate	Easting and Northing Coordinate
Altitude	Altitude	Altitude	Altitude	Altitude
Satellites	Satellites	Satellites	Satellites	Satellites

- Time – Indicates when the last time the location was calculated. The time is provided in Universal Time Coordinated.
- Letter Code – Grid zone or square on the map for different coordinate standard.
- Latitude – Expressed in degrees, minutes, and seconds.
- Longitude – Expressed in degrees, minutes, and seconds.
- Number of satellites – Used to calculate the location. In general, more satellites provides better accuracy. The maximum is 12 satellites.
- Easting – Refers to the eastward-measured distance expressed in meters.

- Northing – Refers to the northward-measured distance expressed in meters.



NOTE: Skipping each digit of easting and northing coordinates decreases the accuracy by the factor of 10.

5.6.5

GNSS Accuracy

The GNSS Location Service accuracy depends on the GNSS coverage.

In good GNSS coverage (at least -130 dBm or in open sky), the location accuracy is < 5 m for 95% of location reports.

5.7

Home Mode Display Text Message

Your radio is provided with a feature that allows your service provider to send special text messages to the display. The message is limited to 24 characters. The message stays on the home screen until a new home mode display message is received. Power cycle your radio to replace the Home Display message to the predefined one.

5.8

Horn and Lights Alarm

The Horn and Lights function allows your vehicle to alert you of an incoming important message.

Pressing the External Alarm Key key toggles the horn and lights feature. When enabled during ignition off, your vehicle horn sounds and the lights flash to announce an incoming private or phone call.



NOTE: The external alarm relay must be installed and the feature must be programmed to work.

5.9

Individual Call

Individual call is a point-to-point call between two TETRA radios.

The available individual calls are:

- Private Call
- Phone Call
- Private Automatic Branch Exchange (PABX) Call

5.9.1

Private Call

Private call, also called point-to-point call, enables communication between two individuals. No other radio can hear the conversation.

This call type can be carried out in two ways:

Duplex Call

This call type is only allowed in Trunked Mode Operation (TMO). During this call, both parties can speak at the same time.

Simplex Call

Available in TMO or Direct Mode Operation (DMO). Only one party can speak at a time.

If configured, your radio can block outgoing private calls. The following are private calls that needs to be blocked in TMO:

- Half Duplex
- Full Duplex
- PSTN (Telephony)
- PABX

The following are private calls that needs to be blocked in DMO:

- Calls between Motorola Solutions radios
- Calls using Repeater
- Calls using Gateway

5.9.1.1

Making Private Calls

Procedure:

1. From the home screen, enter a number.
2. If **Private** is not the first type of call presented, select it by repeatedly pressing **Ctype**.
3. If the Private Call Hook Customization feature is enabled, press **Menu** → **Hook Method** and select the required hook method for simplex and duplex calls.
4. Press **Done**.
5. Use one of the following options:

Option	Actions
Making simplex calls in TMO or DMO	<ol style="list-style-type: none">a. Press and hold the PTT button.b. Wait for the Talk Permit tone before talking.c. Release the PTT button to listen.
Making duplex calls in TMO	<ol style="list-style-type: none">a. Press the Send key.b. You hear a ringing tone until the called party answers the call.

6. To end the call, press the **End** key.



NOTE: If you are using the fist microphone or the telephone style handset, replace it on its clip or holder to end the call.

5.9.2

Phone and PABX Calls

Phone Calls allow you to call a landline telephone number or a cellular mobile phone number. Private Automatic Branch Exchange (PABX) Calls allow you to call local (office) extension numbers.



NOTE: This feature is available only in Trunked Mode Operation (TMO).

The Phone/PABX Speed Dial feature allows you to dial a shortened number of up to three digits instead of the full number. The Phone/PABX **Speed #** number is assigned when the dialed number is added in the contact list.

If configured, your radio can block outgoing private calls. The following are private calls that needs to be blocked in TMO:

- Half Duplex
- Full Duplex
- PSTN (Telephony)
- PABX

The following are private calls that needs to be blocked in DMO:

- Calls between Motorola Solutions radios
- Calls using Repeater
- Calls using Gateway

5.9.2.1

Making Phone or PABX Calls

When and where to use:

This feature is only available in Trunked Mode Operation (TMO).

Procedure:

1. From the home screen, enter the number.
2. If **Phone** or **PABX** is not the first type of call presented, press **Ctype** repeatedly to select it.
3. Press the **Send** key.
4. To end the call, press the **End** key.

 **NOTE:** If you are using the fist microphone or the telephone style handset, replace it on its clip or holder to end the call.

5.9.2.2

Using the Phone/PABX Speed Dial

Procedure:

1. From the home screen, enter the predefined Phone/PABX speed dial number and **#** key.
2. Press **Send** key.

5.9.3

Receiving Individual Calls

Procedure:

1. Use one of the following methods to answer a private, phone, or Private Automatic Branch Exchange (PABX) call.
 - Press the **PTT** button.
 - Press the **Send** key.
 - Remove the fist microphone or the telephone style handset from its clip or holder.

If the microphone or handset is off the hook, the external speaker of the radio mutes and the earpiece of the microphone or handset activates. Depending on their availability, audio is routed to the audio input devices in the following order:

- a. A visor microphone.
- b. A microphone of the device that is off hook.
- c. A microphone that was last in use (if two devices are off hook).

If an accessory is connected through the junction box, the active microphone depends on the hook state of the accessory:

- If the accessory is on the hook, the visor microphone is active.
- If the accessory is off the hook, the microphone of the accessory connected to the telco connector is active.

2. To end the call, press the **End** key.



NOTE: If you hang a fist microphone or telephone style handset into the clip or holder, the call ends or the audio switches to a connected speaker. This call behavior depends on the configuration of your service provider.

5.10

MS-ISDN

This feature adds to your radio ISDN number. You can choose between MS-ISDN and ISSI to address the call, send the message or pre-defined templates. It works for both simplex and duplex calls, based on the assigned ISDN number.

5.11

Multi Radio Control



NOTE: This is a Software Selling Feature.

This feature allows the user to control two radios from a Control Head. The user can monitor one task force and communicate with another task force simultaneously.

Radio 1 is the primary radio and **Radio 2** is the secondary radio. Radio 1 and Radio 2 are connected to each other, with Radio 1 directly connected to the control head.

5.11.1

Selecting Radios

The Control Head only controls one radio at a time.

Procedure:

1. From the home screen, press the **Menu** key.
2. Select **Radio Selection**.
3. Select one of the following options:
 - **Radio 1**

- **Radio 2**

Result: The Radio Selection Tone sounds when a radio is selected using the One-Touch Button or the Radio Selection menu.

 **NOTE:** To enable the Radio Selection Tone feature, check with your service provider.

5.12

OEM Control Head

 **NOTE:** This is a Software Selling Feature.

This feature allows you to connect an Original Equipment Manufacturer (OEM) or third-part Control Head to the transceiver Rear Accessory Connector (RAC). The display of the OEM Control Head has the same functionality and look as a Motorola Solutions Control Head.

The OEM Control Head can be used in one of the following modes:

Single Control Head mode

The OEM Control Head is the only Control Head connected to the transceiver.

Dual Control Head mode

The OEM Control Head is connected to the transceiver together with either IP54 Remote Ethernet Control Head (IP54 RECH), IP67 Remote Ethernet Control Head (IP67 RECH), or Telephone Style Control Head (TSCH).

5.13

One-Touch Dial

This feature allows you to call by pressing and holding one of the keys (1-9).

 **NOTE:** If the One-Touch Button feature is disabled, One-Touch Dial is disabled as a consequence. If no feature is assigned to a button that you press, your radio displays an `Unassigned Button` message. In RMS mode, the One-Touch Button feature is disabled.

5.14

Radio Messaging System (RMS)

 **NOTE:** This is a Software Selling Feature.

The Radio Messaging System (RMS) feature allows the radio to receive and send RMS messages through the TETRA network using the Short Data Service (SDS-TL) or Status (STS) as the transport layer.

 **NOTE:** One-Touch Buttons are disabled in the RMS mode.

There are two types of RMS messages:

- **RMS Status** – a predefined code that is sent bidirectionally between the radio and the service provider. The radio can have up to one hundred statuses that are assigned to numeric keys from 0 to 9. A received RMS status is displayed on the home screen.
- **RMS Free Text** – (available in SDS-TL only) a unidirectional message containing free text that is sent to the radio by the service provider. Since this type of message may be longer, the radio displays only its beginning on the home screen. To view the full message, go to **Menu** → **Messages** → **RMS Box**.

The latest RMS free text or the latest received or sent RMS status is kept on the home screen until the next power cycle.

RMS free text messages and incoming and outgoing RMS statuses are stored in the **RMS Box**. Its capacity is maximum one hundred entries for incoming and outgoing RMS messages. If the **RMS Box** is full, any new incoming or outgoing RMS message overwrites the oldest message (received or sent).

The latest RMS free text is kept on the home screen until the next power cycle. The latest received or sent RMS status is kept on the home screen until the next power cycle or up to 30 seconds (depending on the settings configured by your service provider).





The radio receives and sends RMS messages only from and to the numbers predefined by your service provider.

See [Sending an RMS Status on page 77](#) on how to send an RMS message.

5.14.1

Radio Messaging System Icons

Table 22: RMS Icons

Icon	Description
	RMS Status Received Indicates a new RMS status message just arrived.
	RMS Status Sent
	RMS Box Read Message
	RMS Box Unread Message

5.15

Radio User Assignment (RUA) and Radio User Identity (RUI)

 **NOTE:** This is a Software Selling Feature.

Radio User Assignment (RUA) and Radio User Identity (RUI) enables authentication service. Only a successful logon to any temporary radio, provides full access and your permanent radio functionality, so you can still be reached with your permanent number. A logon failure results in limited service.

You can differentiate the RUA or RUI state by the interface color:

- Blue – You are logged on.
- Gray – You are logged off.

Radio States

- Full Service – You are successfully logon. Your radio has full functionality.
- Limited Service – You are not logged on. Specified by the service provider.
- Pseudo Log On – Occurs only in Local Site Trunking (LST). Your radio has full functionality available (depending on the service provider settings) except some services like forwarding calls. The RUI Pseudo Log On icon is displayed.

Book On

Your service provider assigns a particular radio to one person for a predefined period of time. You are only going to see the screen with your login and the full service is granted.

Force Off

Your service provider can log you off. Radio displays `Force Off`.

5.16

Shadow Groups (Address Bundle)

 **NOTE:** This is a Software Selling Feature.

The Shadow Groups feature (also known as Address Bundle) offers a way of sending messages to multiple destinations or recipients simultaneously. The following types of messages are supported by the feature:

- Status messages (including Emergency Alarms)
- GPS LIP (TETRA Location Information Protocol) reports
- RMS/FMS messages

Shadow Groups in TMO

Each Shadow Group may contain up to four target addresses. Each talkgroup may be configured to send status messages, GPS LIP reports, or RMS/FMS messages to a specific Shadow Group.

Each radio can store up to 500 Shadow Groups (in TMO only).

Shadow Groups in DMO

In DMO, the Shadow Group contains one target address. Each talkgroup may be configured to send status messages or GPS LIP reports to a specific Shadow Group.

The Shadow Groups feature may affect Emergency Calls setup time to be slightly elongated.

5.17

SIM Card End-to-End Encryption

The following table presents interactions occurring between radios with and without SIM cards. SIM cards provide End-to-End Encryption.

 **NOTE:** SIM card End-to-End Encryption supports the Federal Office for Information Security of Germany (BSI) feature only.

Table 23: Interactions between Radios with and without SIM Cards

Transmission Type	Transmitting Radio	Receiving Radio	Result
Private Call	SIM card	No SIM card	The call is not visible for the receiving radio. The transmitting radio displays <code>Called Party Clear Only</code> .
Private Call	No SIM card	SIM card	The <code>Warning: clear call</code> notification appears and the call is received.
Group Call	SIM card	No SIM card	The call is not visible for the receiving radio.

Transmission Type	Transmitting Radio	Receiving Radio	Result
Group Call	No SIM card	SIM card	The warning: clear call notification appears and the call is received.



NOTE:

- To send a message or call a non-SIM card radio, turn off the SIM card End-to-End Encryption.

5.18

Short Number Dial

This feature allows you to dial part of the full number of the person you wish to call. Your radio automatically completes the number.

Your radio number is 4282564.

1. Dial 564 (instead of 4282564, the full number).
2. To place the call, press the **PTT** button or the **Send** key.

5.19

Talkgroup Dialing by Index

This feature allows you to attach to any talkgroup by dialing its index, instead of choosing it from the talkgroup folders and lists.

Dialing by index search from the following list:

- Talkgroup ID/Index
- User defined Index



NOTE: It is also known as Talkgroup Speed Dial.

5.19.1

Viewing the Talkgroup Speed Number

Procedure:

1. From the home screen, press **Options**.
2. Select one of the following options:
 - **TG by Folder** then select the folder and highlight the required talkgroup.
 - **TG by abc** enter up to 15 characters to narrow the talkgroup names and highlight the required talkgroup.
3. Press **Menu** → **View**.

Example:

Radio displays `SpeedNum1 *`, which means that this talkgroup speed number is 1.

5.19.2

Selecting Talkgroups by Index

Procedure:

1. From the home screen, enter talkgroup speed number and *.
2. Press **Attach**.

 **NOTE:** To start a group call, press the **PTT** button.

5.20

Terminal Permanent Disable

 **NOTE:** This is a Software Selling Feature.

Your radio is provided with a feature that allows your service provider to disable it permanently in case it is stolen or lost. When your radio is disabled permanently, it becomes inoperable.

After a Permanent Disable, your service provider cannot enable your radio. It is recommended to Permanent Disable your radio only when you do not expect to recover it. If it is recovered then a Permanent Disable radio can be reactivated by returning it to Motorola Solutions.

5.21

Temporary Disable or Enable

Your radio is provided with a feature that allows your service provider to disable it temporarily in case it is stolen. When your radio is disabled or is powered up in disabled state, it looks and acts like it is turned off.

If your radio is found, your service provider can enable it again over the air. After your radio is enabled, you may resume normal operation.

5.22

Wireless Application Protocol (WAP)

 **NOTE:**

- This is a Software Selling Feature.
- This feature is not supported from MR2022.2 onwards.

Wireless Application Protocol (WAP) is a standard for application layer network communications in a wireless communication environment such as TETRA network. The protocol is used to access the mobile web from a radio through a WAP browser.

5.22.1

WAP Browser

 **NOTE:** This feature is not supported from MR2022.2 onwards.

The Openwave Mobile Browser is a Wireless Application Protocol (WAP)-compliant user agent. The WAP browser, available only in TMO mode and on a network with Packet Data enabled, provides all the basic services of a computer web browser. Depending on the CPS configuration, the display can return to the browser session automatically after an interruption by the preemptive display. The WAP browser does not

support right-to-left languages (as Arabic and Hebrew); English is used instead. The characters of right-to-left scripts are not displayed.

 **NOTE:** Depending on the radio configuration and the network conditions, the WAP browser may not display images properly (or may display them with a delay).

5.22.2

Entering the Browser

Prerequisites: From the home screen, press the **Menu** key. Set **Setup** → **Data Setup** to **Data Only** or **Voice & Data**.

Procedure:

1. From the home screen, press the **Menu** key.
2. Select **Browser**.
3. Optional: Exit the browser by pressing and holding the END key.

5.22.3

Entering Browser Menu Panes

Prerequisites: You are in the browser.

Procedure:

1. Press **Menu** or **Menu** key.
2. Usually, it brings up the Navigate pane, or the last browser menu pane.

 **NOTE:** If the web page you navigated to has two or more soft keys/options, the **Options** pane pops up. From here, you may scroll to other panes with the **Left** or **Right** navigation keys. Or you may select **Browser Menu** and then scroll to the required pane.

5.22.4

Tips for Browsing

Create and use the following steps for easy browsing.

5.22.4.1

Creating Bookmarks through the Navigate Pane

Procedure:

1. Enter the browser and browse to the required page.
2. Press **Menu** to enter the browser menu.
3. Select **Mark Page**.
4. The screen displays the title and URL of the marked page.
5. To save it:
 - a. Press **Save** (or **Select**) to save the page in bookmarks.
 - b. Select **Menu** and select an option:
 - **Save** – Confirms the bookmark creation.
 - **Edit** – Allows you to edit the title, folder, choice, and URL of the created bookmark.

5.22.4.2

Creating Bookmarks through the Bookmarks Pane

Procedure:

1. Enter the browser.
2. Scroll to **Bookmarks** pane.
3. Select **Organise** (if there are no saved bookmarks), or **More...** .
4. Select **Menu**.
5. Scroll to **New Bookmark**.
6. Enter the bookmark title and URL, and select its location.
7. Press **Save**.

5.22.4.3

Using Bookmarks

Procedure:

1. Enter the browser.
2. Scroll to **Bookmarks** pane.
3. Scroll to the required bookmark and select **Go**. The bookmark downloads the selected page from the web.

5.22.4.4

Creating Hotkeys

Procedure:

1. Enter the browser.
2. Scroll to **Bookmarks** pane.
3. Scroll to the required bookmark.
4. Press **Menu**. Select **Hotkeys**.
5. Select an unassigned key (1–9).
6. Click **Assign**. The display shows the bookmark and its assigned hotkey.

5.22.4.5

Using Hotkeys

Procedure:

1. Enter the browser.
2. Press and hold a hotkey to download the corresponding bookmarked page from the web.

5.22.4.6

Saving Pages

When and where to use: Save a page for off-line browsing.

Procedure:

1. Enter the browser and browse to the required page.
2. Press **Menu**.
3. Scroll to **Tools** pane.
4. Select **Save Page**. Edit the proposed page title if required. Scroll down and select **Save**. The page will be saved in the **Bookmarks Saved Pages** folder.

5.22.4.7

Selecting Saved Pages

Procedure:

1. Enter the browser.
2. Scroll to **Bookmarks** pane.
3. Select **Organise** (if there are no saved bookmarks), or **More...** .
4. Select **Go** to enter the Saved Pages folder.
5. Select a saved page and press **OK**. The display shows the saved page. Depending on the saved page, you may browse the web from here.

5.22.5

Disabled Packet Data Service

If there is no Packet Data Service, your radio displays `Error: No Network Available` when entering the browser for the first time. Select **Left** Soft key to retry entering, or **Right** Soft key to enter the browser menu.

When re-entering the browser with previously available Packet Data, your radio displays the last browsed page, or the last page to which you navigated off-line.

5.22.6

Disabled Browser Entry

Browser entry is disabled:

- During any type of voice call, except Ambience Listening Call.
- In DMO Mode.
- During Emergency Mode.
- During PIN lock.
- Service provider has not configured this feature.

- When your radio is disabled.



NOTE:

- Browser entry is enabled during Ambience Listening (AL) Call. If you navigate to previously stored pages, the AL state remains.
- When you activate Packet Data for the first time, AL is disconnected, and you have the same look and feel as if you were not in AL before.

5.22.7

Browser Keys Usage

When the browser is active, the following usage described occurs inside or outside the editor.

Table 24: Browser Keys Interactions

Key Press	Action
0–9 key	<ul style="list-style-type: none"> • In the editor: enters a digit and/or character depending on the text entry mode selected. • Outside the editor: in a numbered list, selects the required item list.
0–9 key (hold)	<ul style="list-style-type: none"> • In the editor: standard use. • Outside the editor: hotkey for navigating to the numbered bookmark.
* key (press or hold)	In the editor, inserts a space.
# key (press or hold)	Brings up the Text Input pane, while in editor. Otherwise, sounds a wrong key press.
Left or Right Soft key	Selects the option that appears in the display directly above the left and right soft key (part of the page).
Up Navigation key	While in list of options, moves up one line.
Up Navigation key (hold)	Moves up on page.
Down Navigation key	While in list of options, moves down one line.
Down Navigation key (hold)	Moves down on page.
Left Navigation key	<ul style="list-style-type: none"> • Moves to the previous pane. • In the editor: moves left.
Left Navigation key (hold)	Functions as backward.
Right Navigation key	<ul style="list-style-type: none"> • Moves to the next pane. • In the editor: moves cursor to the right and inserts space if at the end of the word.
Right Navigation key (hold)	Functions as forward.
Center of Navigation keys (hold)	Auto-repeat.
Menu key	Brings up the browser menu.
End key	Press to deactivate the browser.

Key Press	Action
Send key	Disabled in browser active state.
Rotary Knob	Used for volume adjustment only.
Emergency button	Deactivates the browser. Your radio enters Emergency Mode.

5.22.8

Browser Menu Panes Overview

The browser menu includes the following panes:

Table 25: Browser Menu Panes

Menu Pane	Description
Navigate	Provides access to the home page and commonly used items.
Bookmarks	Provides access, editing, and storage options to stored bookmarks and saved pages.
History	Provides access to recently visited pages and shows the position of the currently loaded page in the history stack.
Tools	Provides access to applications and utilities.

The following panes are displayed according to the context:

Table 26: Additional Menu Panes

Menu Pane	Description
Options	Displayed only when there are additional options for the pane or page.
Image	Displayed only when an image is selected. Provides access to image details, storage, and display use.
Input Text	Displayed only in text entry mode. Provides access to text entry mode (for example, symbol).

5.22.9

Navigate Pane

You can select one of the following items:

- **Home** – for loading the home page.
- **Open Page** – for entering the URL.
- **Search** – item disabled.
- **Mark Page** – for creating (saving) a bookmark for the current document. A title and URL for the bookmark are displayed, and the root folder is chosen for the location.
- **Forward** – for navigating to the document located one step forward in the navigation history. If there is no forward history, this item is disabled.
- **Reload** – for reloading the current document.
- **Advanced...** – see following section.

5.22.10

Advanced...

From the Navigation pane select **Advanced...** to see the following options:

- **Settings...**
 - **Downloads** – for setting download preferences. You may deactivate the downloading of images and objects. The browser displays a special icon instead of the images and objects.
 - **Scroll Mode** – for setting the scrolling mode and speed.
 - **Key Press Timeout** – for setting key press time-out. This time-out is used for text entry.
 - **Set Proxy** – select the WAP Proxy (1, 2, 3). The browser connects to the web via the selected proxy or gateway. The network provider installs and configures the proxy. To establish a secure session, select a secure proxy. Please ask your service provider which proxy is configured for a secure session. Though you can choose your home page, the service provider may decide to force its own home page on your terminal.
 - **Circuit Prompt** – for turning on/off the circuit prompt.
 - **Resend Data Prompt** – for turning on/off the data re-send prompt.
- **Security...**
 - **Secure Prompt** – for enabling/disabling the browser to inform you that it replaced a non-secure connection with a secure connection, and the other way around.
 - **Current Certificate** – for viewing the digital certificate identifying the server that delivers the current document. A Certificate Authority (CA) digitally signs and thus authenticates this certificate. Up to ten additional custom WTLS certificates can be added to the default list of certificates installed. Please ask your service provider if you wish to have these custom WTLS certificates added.
 - **CA Certificates** – for viewing the digital certificates installed in the browser and digitally signed by Certificate Authorities (CA).
 - **Send Referrer** – for turning ON/OFF sending of the HTTP Referrer header as part of HTTP requests. The Referrer header provides the URL of the link source to the server.
 - **Authentication** – for turning ON/OFF the caching of HTTP Authentication credentials. HTTP Authentication protects access to content on the server. If you try to access a protected content, you enter your credentials (user name or password).
- **Clear...** – for clearing of browser data: history, cache cookies, or auto-fill.
- **Restart Browser** – for restarting the browser.
- **About...** – for showing the information about the current version of Openwave Mobile Browser.

5.22.11

Bookmarks Pane

If there are bookmarks in the root folder, select **More...** to access the Options pane. If the root folder is empty, select **Organise...** then press **Menu** key to access the Options pane. The Options pane allows you to manage bookmarks. The **Saved Pages** folder contains snapshots of saved pages.

5.22.11.1

Working with the Options Pane for Selected Bookmarks

Procedure:

1. From the Bookmarks pane select **More...** .

2. Scroll to a bookmark.
3. Press **Menu** to open the Options pane for that bookmark.
4. Select one of the following options:
 - **Back** – for displaying the page associated with the bookmark (page is downloaded if not available in cache).
 - **Details** – for modifying the bookmark title and URL.
 - **Delete** – for deleting the bookmark.
 - **New Bookmark** – for creating a new bookmark.
 - **New Folder** – for creating a new folder.
 - **Move** – for moving this bookmark to a new folder (or in Bookmarks).
 - **Delete All** – for deleting all bookmarks.
 - **Hotkeys** – for assigning hotkeys to available bookmarks.

5.22.11.2

Working with the Saved Pages Folder

Procedure:

1. From the Bookmarks pane select **Saved Pages** folder.
2. The browser displays the page (snapshot) saved using Save Page in Tools pane.
3. Scroll to a saved page.
4. Press **Menu** to open the Options pane for the saved page.
5. Select one of the following options:
 - **Back** – for displaying this page saved on its cache.
 - **Details** – for modifying the page title and URL of the saved page.
 - **Update Page** – for replacing the saved version with the current version (to be downloaded from server).
 - **Delete** – for deleting this page from its cache.
 - **Delete All** – for deleting all the saved pages from its cache.
 - **Cancel** – for exiting this pane and returning to the last page displayed.

5.22.12

History Pane

This pane displays the list of recently visited pages (up to nine history entries can be listed). Each history entry shows its title, if present. Otherwise, `No Title` is displayed.

5.22.12.1

Navigating to Recently Visited URLs

Procedure:

1. Select the URL.
2. Press **OK**.

5.22.13

Tools Pane

Procedure:

1. From the Tools pane select **More...**
2. Scroll to a document.
3. Select **Menu** key to open the Options pane for that document.
4. Select one of the following options:
 - **Show URL** – For displaying the current page URL.
 - **Save Page** – For creating a snapshot for the current document.
 - **Find Text** – For finding a text string in the current document.
 - **Copy Text** – For copying text from the current document to the clipboard.

5.22.14

Options Pane

This pane is specific to the page or pane being displayed.

5.22.15

Text Input Pane

Prerequisites: This pane is visible when the browser menu is opened and text entry field is active.

When and where to use: To input the text for the URL.

Procedure:

1. Select the URL.
2. Press **abc**.
The text input pane opens up.
3. Select **www**.
4. Scroll the required extension (for example: **.com**).
5. Press **.com**. The screen displays the URL with the selected extension.

Table 27: Browser Text Input Icons

Mode	Soft Key	Action
Alphabetic characters - lower case	abc	Enter text in lowercase.
Alphabetic characters - upper case	ABC	Enter text in uppercase.
Numeric	123	Enter numbers and symbols.
http mode	www	Enter.

5.22.16

WAP Push

NOTE:

- This is a Software Selling Feature.
- This feature is not supported from MR2022.2 onwards.

Wireless Application Protocol (WAP) Push allows WAP content to be pushed to a radio. This push is carried out by sending a specially formatted (Push Access Protocol) XML document to the Push Proxy Gateway, that in turn forwards the document to the radio.

A WAP push message is an encoded message including a link to a WAP address. When receiving a WAP push, a WAP enabled radio automatically gives the option to access the WAP content. The implemented WAP push is compliant with WAP 2.0 standard.

The radio supports WAP 2.0 through a proxy only. Proxyless connections are not supported.

5.22.16.1

New WAP Messages

Types of the WAP Messages and their priorities:

NOTE:

- Your service provider sets the priority of the message.

- Push Message
 - High – animation and the icon (blinking) are displayed with the New WAP Message tone and the browser opens.
 - Medium – animation and the icon are displayed with the New WAP Message tone.
 - Low – icon is displayed with the New WAP Message tone.
 - Delete – available only if you are in WAP Box, the text **WAP Message deleted remotely** is displayed, otherwise there is no indication.

 **NOTE:** Animation is not displayed if you are in a call, or in Emergency Mode, or in Call Out, or in message editor, or PIN lock state, or switching to DMO.

- Load Push Message
 - High – browser opens to the user with the New WAP Message tone.
 - Low – the icon is displayed with the New WAP Message tone.

 **NOTE:** The browser does not open if you are in a call, in Emergency Mode, in Call Out, in message editor, in PIN lock state, or when switching to DMO.

5.22.16.2

Viewing WAP Messages

Procedure:

1. From the home screen, press the **Menu** key.
2. Select **Messages** → **WAP Box**.
3. Select the required message.
4. Select **Go to** to view the message in the browser.

Appendix A

LED Indications

Table 28: LED Status Indications

Indication	Status
Solid green	<ul style="list-style-type: none"> ● In use. ● Repeating call.
Blinking green	<ul style="list-style-type: none"> ● In service or idle. ● Switching modes from TMO to DMO.
Solid red	<ul style="list-style-type: none"> ● Out of service.
Blinking red	<ul style="list-style-type: none"> ● Connecting to the network. ● Switching modes from DMO to TMO.
Solid orange	<ul style="list-style-type: none"> ● Radio is powering up. ● Transmit inhibit in service. ● Channel busy in DMO. ● Radio interference in DMO.
Blinking orange	Incoming call.
No indication	<ul style="list-style-type: none"> ● Radio powered down. ● Radio in Covert Mode.

Appendix B

Troubleshooting

Your radio displays the following messages:

Table 29: Displayed Messages

Message	Message Description
Attachment Failed	Your radio could not perform talkgroup attachment. It keeps on trying. If it does not succeed, try another talkgroup.
Authenticate Failure	Your radio could not register on an authenticated system (for example, the Authentication Key is incorrect, or authentication is disabled).
Call Barred	The call is barred due to Barred Incoming Call or Barred Outgoing Call Profile.
Call Cancelled	You have canceled the call.
Call Ended	<ul style="list-style-type: none"> Faulty channel. Please try later. You have ended the call.
Call Forwarding	The radio you are trying to call is not available and the call is being forwarded to another radio.
Call Modified	The call you are participating in has been modified.
Call Preempted	Channel being used for priority.
Decryption Failed:	An error occurred while decrypting a message.
Emergency In Use Wait For Mic	The Hot Microphone feature is active, but the channel transmit grant has been given to another Emergency call on the same talkgroup. Your radio microphone is not active during this time, but it automatically tries to regain talk permit after a predetermined time.
Emgcy Mic Ended	The Hot Microphone timer automatically expired, or you pressed the PTT button to cancel the Hot Microphone feature.
Emergency Mic On	The Hot Microphone feature is active, and your radio is automatically transmitting hands free emergency audio.
Empty Entry	The speed number you dialed does not exist, or the number exists but the group is non-selectable.
Faulty Unit Error	Self-test failed. An operational fault has been detected with your radio. Record the error number. Turn your radio off and contact service.
Gateway available	Your radio has connected to a gateway.
Gateway not available	Your radio cannot connect to a gateway, or connection has been lost.
Individual Calls Only	You can make only individual (private) calls.

Message	Message Description
Insufficient visible data	Your radio is in the process of determining your location. This process may take several minutes to complete.
Insufficient visible satel- lites	Your radio is in the process of determining your location. This process may take several minutes to complete.
Invalid ID	The entered number is not valid.
Invalid Shortcut Position	The entered number is not valid.
Limited Service	Emergency Calls, Emergency Alarms, and mobility operations (for example, group attachment) are allowed. All other incoming and outgoing call and data services are blocked.
List Empty	There are no programmed entries in the scrolling list. Type the entry.
List Not Attached	All talkgroups in the scan list are not attached.
List Partially Attached	The scan list is active, but not all talkgroups are attached to it.
Message Delivered	Indicates mail successfully delivered.
Message Failed	Indicates mail delivery failure.
My Groups Is Empty	You cannot view/delete groups when the My Groups folder is empty.
My Groups Is Full	You are not allowed to add a group to the My Groups folder as it already contains the maximum allowed number of groups.
Network Trouble	Network problems. Please try again later.
New Delivery Status	You have received a new Delivery Status.
No Service	Your radio is outside coverage. Return to coverage.
No Answer	The called party does not answer.
No Entries	This message is displayed when accessing an empty list.
No Group	<ul style="list-style-type: none"> Attachment failed. Your radio detached from current talkgroup. Please wait until it attaches again to the current talkgroup. Displayed when you are out of the normal coverage area of your selected talkgroup. Please select a new talkgroup that is valid for your working location. Indicates a favorite group was removed from the My Groups folder.
No List	The network list is empty.
No New or Old Messages	Indicates there are no new or old messages in the Inbox .
No Selected Scan List	You selected an empty network list.
No Service	Your radio is out of coverage.
Not allowed in repeater mode	The service or feature is not available in the Repeater Mode..
Not Allowed To Initiate Call	You are not allowed to dial a number which is not in the address book.

Message	Message Description
Not Allowed To Transmit	Release the PTT button and try again later. You are not allowed to send a text message or a status message to a number which is not in the address book.
Overheating, Please Turn Radio Off	Your radio turns off. Keep it turned off for 5 minutes.
Party Busy	Called radio is busy.
Party Not Available	Called radio is out-of-range or turned off. Please try again later.
Please Try Again	You could not call.
Please Wait Connecting	A message during startup.
Radio Disabled	Check with your service provider.
Registration Failure	Your radio could not register within the system. Please try again later.
Repeater available	Your radio has connected to a repeater.
Repeater not available	Your radio cannot connect to a repeater, or connection has been lost.
Service Denied	Invalid number. Call your service provider.
Service Not Available	This service is not available on the current network.
Service Restricted	This service or feature is restricted by your service provider, it has not been purchased, or it is not available.
Single TalkGroup Only	There is only one programmed entry in the scrolling list.
TalkGrp ... cannot be deleted	Your service provider set this group so you cannot delete it from the favorite talkgroup folder.
This group already exists	The group you are attempting to add exists in the My Groups folder.
Try Again Later	The requested service is temporarily unavailable.
Unit is OK Warn:	Self-test error. A minor fault has been detected. Your radio is still fully operative. If this error recur, note the error code and contact service.
Unit Not Attached	Your radio could not attach to the system. The talkgroup may not be defined in the system. Please try another group.
Unassigned Button	The message is displayed when no feature is assigned to a button.

Appendix C

Audio Routing and PTT Hook Interactions

Your radio has the following routing schemes.

Available Audio Route Types

The table lists the types of audio route that are available for your radio.

Table 30: Available audio route types

Audio Route Types	
1a	Handset Front-head
1b	Handset Back-head
1c	Handset Rear Accessory Connector (RAC) ¹
2	External Speaker
3a	Hands-free Microphone Back-head ²
3b	Hands-free Microphone RAC
4a	Handheld Microphone Front-head
4b	Handheld Microphone Back-head
4c	Handheld Microphone RAC ¹
5	Line-In
6a	Hearer Speaker Microphone (HSM) Front-head
6b	HSM Back-head
7	Expansion-head Microphone ³
8a	GCAI Headset or Personal Hands-Free (PHF) Front-head
8b	GCAI Headset or PHF Back-head



NOTE: Priority handling are as follows unless stated differently:

- Front-head
- Back-head
- RAC

Audio Routing Schemes

The table lists the available audio routing schemes.

¹ Not available with Multi Radio Control feature enabled.

² Not available with Dual Control Head feature enabled.

³ Not available with Multi Radio Control or Dual Control Head feature enabled.

Table 31: Audio Routing Schemes

Call Type	Answering Method	Audio Routing
Full Duplex Private Call (FDPC) / Phone / PABX	Perform one of the following actions: <ul style="list-style-type: none"> ● Press Send key. ● Press any key, if Voice Services Options is enabled by your service provider. 	To the hands-free microphone, if configured. Applicable only for: <ul style="list-style-type: none"> ● Hands-free microphone back-head ● Hands-free microphone RAC ● External speaker <hr/> To the handset taken off hook. Applicable only for: <ul style="list-style-type: none"> ● Handset front-head ● Handset back-head ● Handset RAC ● External Speaker⁴ <hr/> To the HSM / HSM2 if connected (with or without a secondary accessory). Applicable only for: <ul style="list-style-type: none"> ● HSM Front-head ● HSM Back-head <hr/> To the GCAI Headset / PHF. Applicable only for: <ul style="list-style-type: none"> ● GCAI headset / PHF front-head ● GCAI headset / PHF back-head ● External speaker⁴ <hr/> To the line-in rear accessory, if configured by your service provider. Applicable only for: <ul style="list-style-type: none"> ● Line-in ● External speaker <hr/> To external speaker.
Half Duplex Phone Call (HDPC)	Press Earpce softkey. OR FDPC had been initiated and modified to HDPC by the SwMI.	Take the handset off hook. To handset taken off hook. <hr/> Routing is as follows: <ul style="list-style-type: none"> ● To the external speaker on the transceiver of the control head the call is answered from. ● To the handset taken off hook on the transceiver of the control head the call is answered from. ● To one of the following routes, by priority: <ul style="list-style-type: none"> ○ To the IMPRES handset earpiece if the IMPRES handset is taken off hook.

⁴ If the external speaker is permanently disabled when there is an incoming call, there is no receive audio in the external speaker. The state of the external speaker can be toggled On or Off at any time by pressing the Speaker **On / Off** button.

Call Type	Answering Method	Audio Routing
		<ul style="list-style-type: none"> ○ To the HSM / HSM2 earpiece if the HSM / HSM2 is connected to the control head. ○ To the GCAI headset / PHF earpiece if the GCAI headset / PHF is connected to the control head. ○ To the external speaker.⁵
FDPC / Phone / PABX and HDPC	Press PTT on the handset (On hook).	To the external speaker.
	Press PTT on the handset (Off hook).	To the handset PTT is pressed.
	Press PTT on the handheld microphone (On / Off hook).	To the handheld microphone PTT is pressed.
	Press PTT on the hands-free microphone.	To the hands-free microphone associated with the pressed PTT .
	Press external PTT , when Line-in rear accessory is configured by your service provider.	To the line-in and to the external speaker.
	Press PTT on the HSM.	To the HSM PTT is pressed.
	Press PTT on the GCAI headset / PHF.	To the GCAI headset / PHF PTT is pressed.
	HDPC auto-answer.	Routing is as follows: <ul style="list-style-type: none"> ● To the external speaker on the transceiver. ● To the handset of the transceiver if taken off hook. ● To one of the following routes, by priority: <ul style="list-style-type: none"> ○ To the IMPRES handset earpiece if the IMPRES handset is taken off hook. ○ To the HSM / HSM2 earpiece if the HSM / HSM2 is connected to the control head. ○ To the GCAI headset / PHF earpiece if the GCAI headset / PHF is connected to the control head. ○ To the external speaker.⁵
Press extension-head PTT .	To the extension-head microphone and to the external speaker.	
Using AT commands (virtual PTT).	To one of the following routes, by priority: <ul style="list-style-type: none"> ● To the handset RAC if taken off hook. 	

⁵ Available only for radios with Dual Control Head feature enabled. There is only one receiving audio path on the control head (front-head GCAI OR back-head GCAI OR external speaker). In case both the handset and external speaker are connected to control head, handset shall have a priority for receiving audio if it is taken off hook.

Call Type	Answering Method	Audio Routing
		<ul style="list-style-type: none"> ● To the handheld microphone RAC if taken off hook. ● To the hands-free microphone RAC. ● To the line-in. ● To the handset front-head if taken off hook. ● To the handset back-head if taken off hook. ● To the HSM front-head. ● To the HSM back-head. ● To the handheld microphone front-head. ● To the handheld microphone back-head. ● To the headset / PHF front-head. ● To the headset / PHF back-head. ● To the hands-free microphone back-head.^{5 6}
Group Call	Not applicable.	<p>Routing is as follows:</p> <ul style="list-style-type: none"> ● To the external speaker on the transceiver. ● To the handset of the transceiver if taken off hook. ● To one of the following routes, by priority: <ul style="list-style-type: none"> ○ To the IMPRES handset earpiece if the IMPRES handset is taken off hook. ○ To the HSM / HSM2 earpiece if the HSM / HSM2 is connected to the control head. ○ To the GCAI headset / PHF earpiece if the GCAI headset / PHF is connected to the control head. ○ To the external speaker.⁵



NOTE: There is one PTT line from the Junction Box. When pressing **PTT**, the active mic (on TELCO or hands-free microphone) depends on TELCO hook signal:

- if OFF hook, TELCO mic is opened,
- else, hands-free mic is opened.

PTT and Hook Interactions for Group Calls

The table lists the available PTT and Hook interactions for Group calls.

⁶ Available only for radios with Multi Radio Control feature enabled. There is only one receiving audio path on the control head (front-head GCAI OR back-head GCAI). In case both the handset and external speaker are connected to control head, handset shall have a priority for receiving audio if it is taken off hook.

Table 32: PTT and Hook Interactions for Group Calls

Active Audio Routing	Event	Next Audio Routing
Any accessory with hook signal	GCAI active accessory is placed on hook.	If Accessories Options is enabled by your service provider, audio routing shall follow 'Group Call' in Table 31: Audio Routing Schemes on page 156 . ^{7 8}
	TELCO active accessory is placed ON hook.	If Accessories Options is enabled by your service provider, audio routing shall be routed through the hands-free microphone on the RAC and the associated external speaker.
	An inactive handset is placed on hook.	Audio routing shall follow Table 31: Audio Routing Schemes on page 156 .
Any	PTT from any handset placed on hook.	Receiving audio shall be routed to the external speaker associated with the same control head as the handset and no microphone will be opened. ^{7 8 9}
	PTT from any handset taken off hook or from any other accessory (independent of hook state).	Audio routing shall follow 'Group Call' in Table 31: Audio Routing Schemes on page 156 .
	PTT through AT commands.	Audio routing shall follow 'Using AT commands (virtual PTT)' in Table 31: Audio Routing Schemes on page 156 .
	Any handset is taken off hook.	<ul style="list-style-type: none"> ● Radios with Dual Control Head or Multi Radio Control features enabled: <ul style="list-style-type: none"> ○ Audio routing shall follow 'Group Call' in Table 31: Audio Routing Schemes on page 156. ● Others: <ul style="list-style-type: none"> ○ To another handset if the other handset is a GCAI (receiver or receiver-transceiver) handset. ○ Else, audio routing shall follow 'Group Call' in Table 31: Audio Routing Schemes on page 156.
	TELCO handset is taken off hook.	If the previous active accessory is a hands-free microphone on RAC, audio shall be routed through TELCO handset, else rout-

⁷ Press **PTT** to transmit.

⁸ For radios with Dual Control Head feature enabled only. The Key Press Token rules apply when **PTT** pressed is associated with the other control head than the current active accessory is associated with.

⁹ The associated external speaker state (On / Off) shall not be changed. If the speaker is disabled, receiving audio will not be heard. The state of the external speaker can be toggled On or Off at any time by pressing the Speaker **On / Off** button.

Active Audio Routing	Event	Next Audio Routing
		ing remains unchanged unless PTT is pressed.