



MOTOROLA

MTP850/MTP850 S/MTP850 FuG TETRA Handportable Terminal

Basic User Guide



When printed by Motorola

Contents

| | |
|---------------------------------------|-----------|
| Safety Information | 4 |
| Disposal Information | 4 |
| Copyright Information | 4 |
| Icon Conventions | 5 |
| MTP850 Overview | 6 |
| Controls and Indicators | 6 |
| Audio Signal Tones | 8 |
| Periodic Alert | 11 |
| Key, Knob, and Button Overview | 11 |
| On-Off/End/Home Key | 11 |
| Soft Keys | 11 |
| Menu Key | 11 |
| Rotary Knob | 11 |
| Emergency Button | 12 |
| Function Keys | 12 |
| Speaker Control Key | 13 |
| Volume Adjustment Mode | 13 |
| Audio Profile | 13 |
| Howling Suppression | 14 |
| The LED Status Indicator | 14 |
| To Enter the Menu Items | 14 |
| To Return to the Previous Level | 14 |
| To Exit the Menu Items | 14 |
| List of Menu Items | 15 |
| The Display | 19 |
| Status Icons | 19 |
| Menu Icons | 22 |
| Inbox Icons | 23 |
| Contact Icons | 23 |
| Outbox Icons | 24 |
| Text Entry Icons | 24 |
| Getting Started | 27 |
| Battery | 27 |

| | |
|--|-----------|
| Installing the Battery | 27 |
| Replacing the Battery | 27 |
| Charging the Battery | 28 |
| Battery Capacity Information | 28 |
| Attaching the Antenna | 29 |
| Powering On/Off (On-Off/End/Home Key) | 29 |
| Powering On (Emergency Button) | 29 |
| Powering On with Transmit Inhibit (TXI) Active | 29 |
| Unlocking the MTP850 | 30 |
| Locking/Unlocking the Keypad | 30 |
| Radio User Identity (RUI) | 31 |
| Selecting TMO or DMO Operation | 32 |
| Entering TMO or DMO | 32 |
| Group Calls | 33 |
| Favorite Folders | 33 |
| Selecting the “My Groups” Folders | 33 |
| Adding a Group (TMO/DMO) | 33 |
| Deleting a Group (TMO/DMO) | 33 |
| Renaming Favorite Folder | 34 |
| Deleting Favorite Folder | 34 |
| Selecting a Group | 34 |
| Using the Rotary Knob | 34 |
| Using the Navigation Key | 34 |
| Using Alphabetic Search | 34 |
| Using Folder Search | 35 |
| Using the Numeric Keypad - Speed Dialing | 35 |
| Selecting a Folder | 35 |
| TMO Group Calls | 35 |
| Making a TMO Group Call | 36 |
| Receiving a TMO Group Call | 36 |
| Receiving a TMO Broadcast Call | 36 |
| PTT Double Push | 36 |
| DMO Group Calls | 37 |
| Making a DMO Group Call | 37 |
| Receiving a DMO Group Call | 37 |
| Exiting DMO | 37 |

| | |
|---|-----------|
| Private, Phone, and PABX Calls | 38 |
| Creating a Contact | 38 |
| How to Dial | 38 |
| Dialing a Number | 38 |
| Dialing via the Contact List | 39 |
| Speed Dial | 39 |
| Private Call | 39 |
| Making a Private Call | 39 |
| Receiving a Private Call | 40 |
| Phone and PABX Calls | 40 |
| Making a Phone or PABX Call | 40 |
| Emergency Mode | 41 |
| Entering or Exiting Emergency Mode | 41 |
| Sending an Emergency Alarm | 41 |
| Hot Microphone Feature | 42 |
| Making an Emergency Group Call | 43 |
| Silent Emergency Mode | 43 |
| Call-Out | 43 |
| Messages | 45 |
| Sending a Status Message | 45 |
| Sending a New Message | 45 |
| Sending a User-defined Message | 45 |
| Sending a Predefined Message | 45 |
| Handling New Incoming Text Messages | 45 |
| Handling Unread (New) Messages | 46 |
| Tips & Tricks | 47 |
| Quick Reference Guide | 51 |

© Motorola Inc., 2009

MOTOROLA and the stylized M Logo are registered in the U.S. Patent and Trademark Office. All other product or service names are the property of their respective owners.

Safety Information



CAUTION

Before using these products, read the operating instructions for safe usage contained in the Product Safety and RF Exposure booklet 6864117B25

The MTP850 is restricted to occupational use only to satisfy ICNIRP RF energy exposure requirements. Before using the products, read the RF energy awareness information and operating instructions in the Product Safety and RF Exposure booklet (Motorola Publication part number 6864117B25) to ensure compliance with RF energy exposure limits.

Keep this **User Guide** and the **Product Safety and RF Exposure booklet** in a safe place and make it available to other operators in case the accessories are passed on to other people.

Disposal Information



The **European Union Waste of Electrical and Electronic Equipment** directive requires that products sold into EU countries must have the crossed out trashbin label on the product (or the package in some cases). As defined by the WEEE directive, this cross-out trashbin label means that customers and end-users in EU countries should not dispose of electronic and electrical equipment or accessories in household waste.

Customers or end-users in EU countries should contact their local equipment supplier representative or service centre for information about the waste collection system in their country.

Copyright Information

The Motorola products described in this manual may include copyrighted Motorola computer programs stored in semiconductor memories or other mediums. Laws in the United States and other countries preserve for Motorola certain exclusive rights for copyrighted computer programs, but not limited to, including the exclusive right to copy or reproduce in any form the copyrighted computer program.

Accordingly, any copyrighted Motorola computer programs contained in the Motorola products described in this manual may not be copied, reproduced, modified, reverse-engineered, or distributed in any manner without the express written permission of Motorola. Furthermore, the purchase of Motorola products shall not be deemed to grant either directly or by implication, estoppel, or otherwise, any licence under the copyrights, patents, or patent applications of Motorola, except for the normal non-exclusive licence to use that arises by operation of the law in the sale of a product.

This document is copyright protected. Duplications for the purpose of the use of Motorola products are permitted to an appropriate extent. Duplications for other purposes, changes, additions or other processing of this document are not permitted. Only this electronically-saved document is considered to be the original. Duplications are considered merely copies. Motorola, Inc., and its subsidiaries and affiliates do not vouch for the correctness of such kinds of copies.

Icon Conventions

The document set is designed to give the reader more visual cues. The following graphic icons are used throughout the documentation set. These icons and their associated meanings are described below.



WARNING

*The signal word **Warning** with the associated safety icon implies information that, if disregarded, could result in death or serious injury, or serious product damage.*



CAUTION

*The signal word **Caution** with the associated safety icon implies information that, if disregarded, may result in minor or moderate injury, or serious product damage.*

CAUTION

*The signal word **Caution** may be used without the safety icon to state potential damage or injury that is not related to the product.*

NOTE

Notes contain information more important than the surrounding text, such as exceptions or preconditions. They also refer the reader elsewhere for additional information, remind the reader how to complete an action (when it's not part of the current procedure, for instance), or tell the reader where something is located on the screen. There is no warning level associated with a Note.

MTP850 Overview

NOTE *The Man Down feature is restricted only to MTP850 S and MTP850 FuG terminals.*

Controls and Indicators

The numbers below refer to the illustration on the inside front cover.

| Number | Description |
|--------|---|
| 1 | Antenna |
| 2 | Top Microphone Activated during Simplex, high-audio calls such as Group Calls. |
| 3 | External Antenna Connector Used with the digital car kit to connect the RF signal to the external antenna. (At the back of the MTP850) |
| 4 | Colour Display Provides alphanumeric text and images within 65,536 colors and 130 x 130 pixels with backlight, scalable fonts, and contrast. |
| 5 | On-Off/End/Home Key <ul style="list-style-type: none">• Press and hold to turn the MTP850 On/Off.• Press to end calls.• Press to return to the Home display (idle screen). |
| 6 | Four Way Navigation Key Press up, down, left or right for list scrolling, while moving around the menu hierarchy, or for alphanumeric text editing. |
| 7 | Audio Accessory Connector (At the side of the MTP850) |
| 8 | Alphanumeric Keypad Use the keypad to enter alphanumeric characters for dialing, contact entries and text messages. |
| 8 a | Sensor for keypad backlight On/Off |
| 9 | Bottom Microphone Activated during Simplex and Duplex, low-audio calls such as Phone Calls. |
| 10 | Accessory Connector Provides connection for accessories. (At the base of the MTP850) |

| Number | Description |
|--------|---|
| 11 | Speaker Control Key Selects earpiece (low audio), PHF (low audio) or speaker (high audio). |
| 12 | Speaker (under keypad) |
| 13 | Send Key Used to initiate or answer Duplex calls (such as Phone Calls), or send status and text messages. |
| 14 | Menu Key Used to enter the main menu and the context sensitive menu. |
| 15 | Soft Key(s) Press to select the option that appears in the display directly above the left or right soft key. |
| 16 | Push-To-Talk Button (PTT) Press and hold this side button to talk in Simplex calls, release it to listen. Press to send status and text messages. |
| 17 | Programmable Side Keys 1 and 2 Default programming: upper Side key activates/deactivates Backlight; lower Side key activates Screen Saver. (See also No. 19) |
| 18 | Earpiece |
| 19 | Programmable Rotary Knob Default programming: "Dual" – Press the knob to toggle between "volume" and "list". Side keys (No. 17) operate as programmed. |
| 20 | Emergency Button (on top of the MTP850) Press and hold to enter Emergency Mode, and send Emergency Alarms (as programmed). When the MTP850 is Off, press and hold to power on in Emergency Mode or in normal mode (as programmed). |
| 21 | LED (Indicator) |
| 22 | Accessory Connector Provides connection for accessories. (At the side of the MTP850 S/MTP850 FuG) |

NOTE

Before using your MTP850 for the first time, remove the plastic lens protector from the display, and charge the battery overnight to ensure battery is initialised to its full capacity.

NOTE









Take care to clean the bottom connector frequently and particularly prior to the programming procedure e.g. with a soft brush (do not use fluids).









NOTE

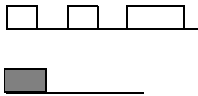

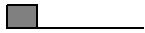
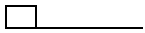

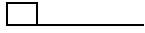

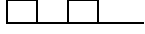
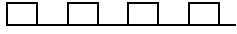

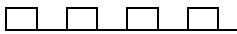
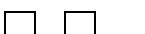





It is recommended to turn off the terminal before connecting any of the accessories.

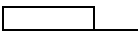
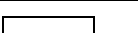

Audio Signal Tones

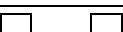
□ = High Tone; ■ = Low Tone;

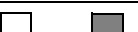
| Description | Type | Repeated |
|--|---|---|
| Idle | | |
| <ul style="list-style-type: none"> • Back to Home display • Back to rotary volume use when rotary scroll timer expires • Back to coverage • Back to full service |  | Once |
| Clear to send |  | Once |
| Bad key press |  | Once |
| <ul style="list-style-type: none"> • Good key press • MTP850 self-test fails at power up • From out-of-service to in-service |  | Once |
| In Call | | |
| Call clear warning |  | Once |
| Call waiting tone while Phone or Private Call are pending. |  | Every 6 seconds, until a call is terminated |
| Data connected or Data disconnected |  | Once |
| Talk Permit sounds upon pressing the PTT |  | Once (Normal Tone) |
| |  | Once (Short Tone) |

| Description | Type | Repeated |
|--|---|--|
| Talk permit without gateway sounds upon pressing PTT. The tone indicates the gateway is no longer available |  | Twice Once |
| <ul style="list-style-type: none"> • Talk prohibit • System busy • Time-out timer expire • Called MTP850 not available or busy |  | Until you release the PTT. |
| Call disconnected or failed due to network |  | Once |
| Wrong number dialed | | No tone |
| DMO (Direct Mode) Entering |  | Once |
| DMO Exiting |  | Once |
| Local site trunking — Entering/Exiting |  | Once |
| Phone ring back (sending) |  | Every three seconds, until the called user answers or call is rejected |
| Phone busy |  | Every 0.5 seconds |
| Status message sent to the dispatcher or failed |  | Twice |
| Incoming Calls | | |
| Status message acknowledged by the dispatcher |  | Four times |
| Your MTP850 received a Group Call without gateway (setup only) |  | Once |
| High-priority Group Call received |  | Once |
| Emergency Alarm sent or received |  | Twice |

| Description | Type | Repeated |
|--|---|--|
| Emergency Alarm failed |  | Four times |
| Emergency Call received |  | Once |
| Phone ring, Duplex Private Call (reception) | According to the Ring Style sub-menu setting. | Until you answer or the call is rejected |
| Private Call received | According to the Ring Style sub-menu setting. | Until you answer or the call is rejected |
| Private Call ringing to the caller |  | Until the call is answered |
| Simplex Private Pre-emptive Priority Call (PPC) ring |  | Every 4 seconds, until the call is answered or rejected. |
| Duplex Private PPC ring |  | Every 4 seconds, until the call is answered or rejected. |
| Limited service |  | Once, upon entering limited service. |
| New mail received |  | Once |
| New Group Call |  | Once |
| General | | |
| Volume setting (earpiece, keypad, speaker) |  | Continuous |
| Volume setting (ringer) |  | While setting the volume. |
| Transmit Inhibit (TXI) |  | Once |
| Man Down feature is on |  | Once |
| Man Down feature is off |  | Once or Repeated |
| Man Down pre-alert |  | Once |
| Man Down device failure |  | Until the feature is disabled |
| Double PTT - Single Tone |  | Once |

| Description | Type | Repeated |
|--------------------------|---|----------|
| Double PTT - Double Tone |  | Once |
| Double PTT - Triple |  | Once |

Periodic Alert

Periodic alert indicates the missed calls and the unread messages. For each indication the unread message tone is played with the orange LED color.



This feature can be disabled/enabled by the user. Press  and select > **Setup** > **Tones** > **Periodic Alert** also to set the period of time between the indications.

Key, Knob, and Button Overview

On-Off/End/Home Key

- Press and hold to turn the MTP850 On/Off.
- Press to end calls.
- Press to return to the Home display.

Soft Keys

Press  or  to select the option that appears in the display directly above the left or right soft key.

Menu Key

Menu key has two functions. Press  to enter:

- **The menu** (when not in the menu). The MTP850 menus allow you to control your MTP850 settings.
- **Context sensitive menu** (when  icon is on and while not on Idle screen) to view a list of items for the current menu.

Rotary Knob

The Service Provider can program the Rotary knob to one of the following uses:

1. **Dual control** – the knob is used as both a volume control and to scroll through lists. Press the knob to toggle between volume and list control (default programming).
2. **List control** – the knob is used to scroll lists (e.g. Talk group lists) or menu items. In this case volume control is always via the Side keys.
3. **Volume control** – the knob is used only as a volume control; turn clockwise to increase the audio volume level.

Press and hold the Rotary knob to lock it, press and hold it again to unlock. Powering Off also unlocks a locked Rotary knob.

Emergency Button

Press and hold this button to enter Emergency Mode.

When the MTP850 is powered down, press and hold this button to power On in Emergency Mode or in standard mode (as programmed).

Function Keys

NOTE For information on the function assigned to each Side, Numeric, *↵ or #↵ keys, please refer to your Service Provider.

NOTE The required time you need to press the Side, Numeric, *↵ or #↵ keys to activate a one-touch function is set as default to 1 second. This time may be set, however, by your Service Provider.

Side Keys

The Rotary knob and Side key programming are paired:

| Rotary Knob Programming | Side Key Programming |
|-------------------------|------------------------------------|
| Dual control | Programmed to a one-touch function |
| List control | ○: Volume Up ●: Volume Down |

| Rotary Knob Programming | Side Key Programming |
|-------------------------|------------------------------------|
| Volume control | Programmed to a one-touch function |

When the Rotary knob is programmed to volume control or dual control, the Side keys support the one-touch feature that allows you to select or activate commonly used features by pressing and holding a single key. By default, the upper Side key is set to “Backlight On/Off” and the lower Side key is set to “Screen Saver On”. Please check with your Service Provider.

Numeric, * (Mute) and # (Redial) Keys

The MTP850 supports the one-touch feature that allows you to select or activate commonly used features by pressing and holding an assigned key.

One Touch Private Call

The MTP850 supports the one-touch private call if it is set by the Service Provider. User can dial the last group call originator number via pressing the assigned one touch private call button.

Speaker Control Key

Press  to activate the earpiece (low audio), PHF (low audio) or speaker (high audio), depending on the menu settings.

| Type of Call | Menu Setting | Key Use |
|---|---|--|
| Simplex call (Group*/Private) | Menu > Setup > Audio > Audio Toggle > Spkr Cntrl | Speaker On/Off for Group and Private Calls |
| | Menu > Setup > Audio > Audio Toggle > Always Loud | Speaker On/Off for Private Call |
| Duplex call (Private/Phone/ PABX) | ----- | Controls speaker/earpiece of the on-going call |

** In an Emergency Group Call, the voice sounds from the speaker regardless of the speaker setting.*

Volume Adjustment Mode

The Service Provider can enable Volume Adjustment Mode feature. All the settings regarding **Individual** mode are adjustable and retained even if the user switches back to **Common** mode.

In **Common** mode the user adjusts all the **Volumes** at the same time.

To change the volume setting or settings, press **MENU** > **Setup** > **Set Volume**.

Audio Profile

An audio profile is a profile that adjusts the audio parameters of the terminal to fit its current operating environment.

To select an Audio Profile, press **MENU** and select **Setup** > **Audio** > **Audio Profile**. Scroll and choose your required template.

Howling Suppression

Howling Suppression is a mode of operation that eliminates howling effect.



To enable or disable Howling Suppression, press **MENU** and select **Setup** > **Audio** > **Howling Supr**. Scroll and choose respectively Enabled or Disabled.

The LED Status Indicator

The LED indicator shows the states of your MTP850.

| Indicator | Status |
|-------------------------------------|--|
| Solid green | In use |
| Flashing green | In service |
| Solid red | Out of service |
| Flashing red | Connecting to a network/Entering DMO |
| Solid orange | Transmit Inhibit (TXI) in service / Channel busy in DMO |
| First solid then flashing orange | Incoming call |
| No indication | Switched off |

To Enter the Menu Items

1. Press .
2. Scroll to the required item, press **Select** or  to select.

To Return to the Previous Level

Press **Back** or .

To Exit the Menu Items

Press .

NOTE *Your MTP850 may exit if no key press is detected for a time-out period.*

List of Menu Items

English

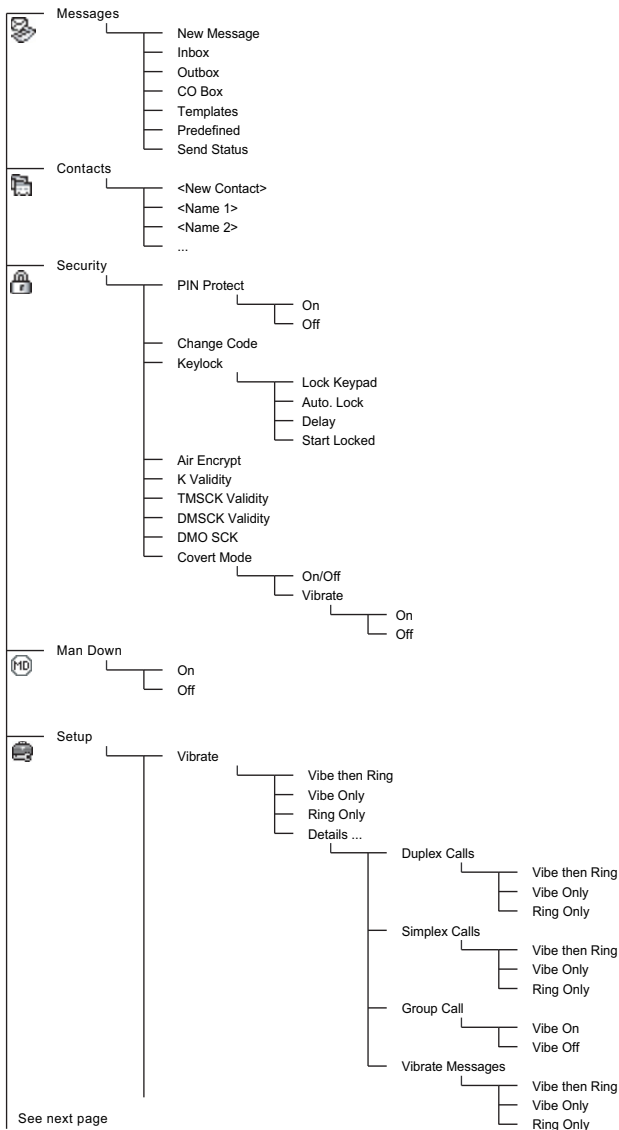

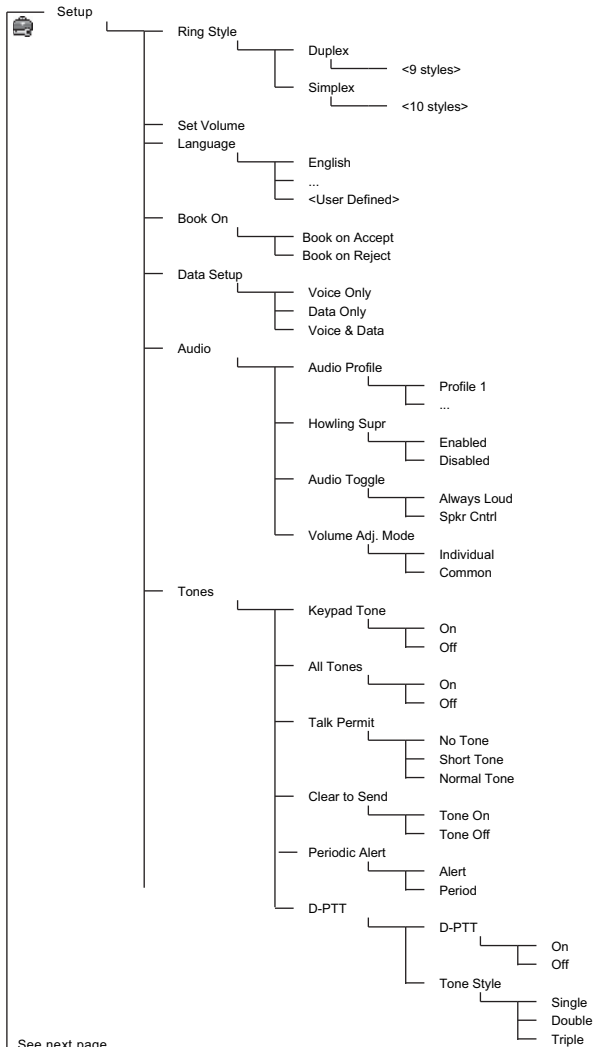

See next page

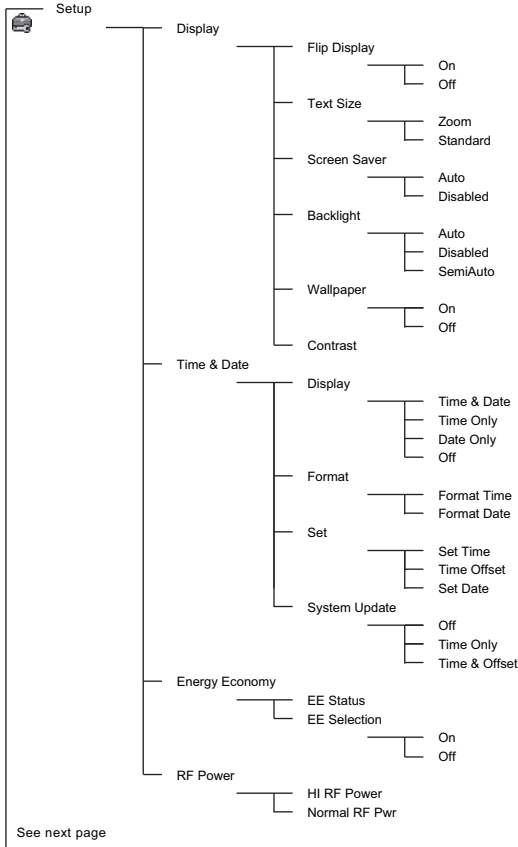

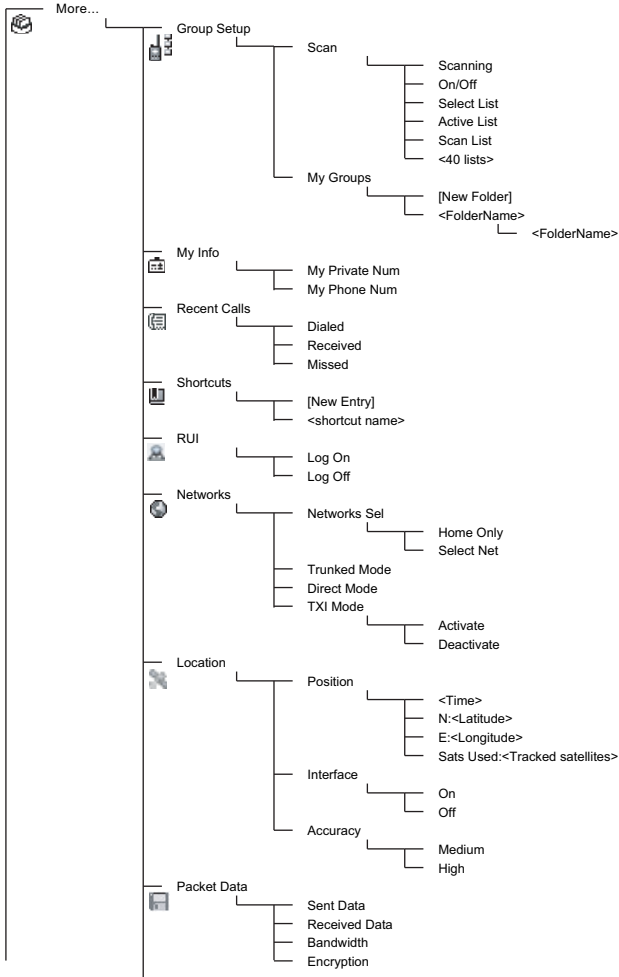

NOTE

This is the standard menu layout. Your Service Provider may enable/disable some menu items or change their names.

Creating Menu Shortcuts

Use shortcuts to access frequently-used menu items.

Menu Shortcut Creation

Navigate to the menu item and press and hold  as the item is highlighted.

Menu Shortcut List

To look for assigned shortcuts, press  and select **More... > Shortcuts > <shortcut name>**.

Menu Shortcut Use





From Home display, press  and the numeric key(s) assigned to the shortcut.







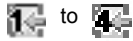

The Display















When you use your MTP850, icons appear on the display to indicate the following conditions.

Status Icons

Status icons appear when your phone is engaged in certain activities or when you have activated certain features.

| Status Icon | Description |
|--|---|
| Trunked Mode Operation (TMO) | |
|  | Signal Strength Allows you to check signal strength. More bars indicate a stronger signal. |
|  | No Service |
|  | Scan Indicates scanning is activated in the MTP850. |
|  | Data Connected Displayed when the MTP850 is successfully connected to an external device and ready for data transfer. |
|   | Data Transmit/Receive Displayed when the MTP850 is transferring data to/receiving data from the external device (laptop or desktop PC). No number – standby data session. Number 1, 2, 3, or 4 – indicates active data session with 25%, 50%, 75%, or 100% bandwidth. |









| Status Icon | Description |
|---|--|
| Direct Mode Operation (DMO) | |
|  | Signal Strength Indicates an incoming Direct Mode Group Call. |
|  | Direct Mode Displayed when the MTP850 is in Direct Mode. |
|  | DMO Gateway Indicates that gateway is selected. The icon has three states: Solid – while the MTP850 is synchronised with the gateway. Flashing – while the MTP850 is not synchronised or during attachment. No icon – during a terminal to terminal and repeater call. |
|  | DMO Repeater Displayed when the repeater option in DMO is selected. This icon has three states: Solid – while the terminal has detected the repeater (i.e., when the terminal receives a presence signal). Blinking – while the terminal has not detected the repeater or during attachment. No icon – during a terminal to terminal and gateway call. |
| General Icons | |
|  | All Tones Off / Duplex & Simplex Ring Muted Indicates that all alert tones are off in the MTP850 or both Simplex Ring volume is set to 0 and Duplex Ring volume is set to 0. |
|  | Simplex Ring Muted Indicates that Simplex Ring volume is set to 0 and Duplex Ring volume is set to more than 0. |
|  | Duplex Ring Muted Indicates that Duplex Ring volume is set to 0 and Simplex Ring volume is set to more than 0. |
|  | Vibrate On Indicates that the MTP850 will vibrate to alert you of an incoming call. |
|  | Vibrate then Ring Indicates that the MTP850 will vibrate then ring to alert you of an incoming call. |

| Status Icon | Description |
|---|---|
|  | Speaker Off (Low Audio) Indicates that the audio will sound through the earpiece. (See detailed explanation of Speaker Control key.) |
|  | Low Audio Indicates that the audio mode is changed to low. |
|  | High Audio Indicates that the audio mode is changed to high. |
|  | Earpiece Connected Indicates that the earpiece is connected. |
|  | RUI Pseudo Log On Indicates that the user is pseudo logged on. |
|  | Pseudo Log On with Packet data Indicates that the user is pseudo logged on and Packet Data at the same time. |
|  | Battery Strength Shows the charge in your battery. Full icon is full charge. |
|  | RF Power Indicates the High RF Power is enabled. Shows the signal strength. More bars indicate a stronger signal. |
|  | Emergency Appears while the MTP850 is in Emergency Mode. |
|  | List Scrolling Displayed to indicate that the Rotary knob use is list scrolling, as long as this use is selected. |
|  | New Message Has Arrived Indicates a new message just arrived. |
|  | New Message(s) in Inbox Indicates that you have unread messages in your inbox. |
|  | Man Down Active (Blue) Indicates that the Man Down feature is active. |
|  | Man Down Alert (Red) Displayed when the Man Down feature is active. This icon has two states: Blinking – pre-Alert; the terminal signalizes Man Down conditions. To exit the pre-Alert state, change the conditions or press the PTT button. Solid – the terminal entered the Alert mode. |

| Status Icon | Description |
|---|--|
|  | Man Down Failure Indicates the Man Down device failed. |





Menu Icons

The following icons make it easy to identify the menu items at first glance.

| Menu Icon | Description |
|---|---|
|  | Main Menu Items/Context Sensitive Menu Appears above  if the main menu items/context sensitive menu are active. |
|  | Messages <ul style="list-style-type: none"> • Send status messages, • Send text messages (free text or according to user defined or predefined templates), • Receive messages in inbox. |
|  | Contacts Add, search, edit, or erase entries in the contact list. |
|  | Security Lets you turn On/Off and verify security features, and change passwords. |
|  | Setup Allows you to customise your MTP850. |
|  | More... Contains more customisable menu items. |
|  | Scroll Bar Indicates navigation among items that occupy more than one screen. If all items appear in one screen, the scroll bar is empty. |







Inbox Icons

The following icons indicate the status of messages in the inbox.

| Inbox Icon | Description |
|---|---|
|  | Unread (New) Message Indicates that you have not read the message yet. |
|  | Read (Old) Message Indicates that you have read the message. |
|  | Sender Information in Message View Indicates sender information (name or number). |
|  | Time and Date Stamp in Message View Indicates the time and date of message arrival. |
|  | Delivery Status Received Indicates delivery status for Store & Forward messages. |



Contact Icons

In the contact list display, the following icons may appear next to the contact numbers to indicate the type of stored number.

| Contact Icon | Description |
|---|---|
|  | Private ID Number |
|  | Mobile Phone Number |
|  | Home Phone Number |
|  | Work Phone Number |
|  | PABX Number |
|  | Other Phone Number |
|  | Pickers Indicate more than one number is stored with the contact. |

Outbox Icons

In the Outbox submenu those three icons indicate the process of sending the Store & Forward messages. For more information please contact your Service Provider.

| Outbox Icon | Description |
|---|------------------------------|
|  | Delivery in Progress |
|  | Delivery Accomplished |
|  | Delivery Failed |

Text Entry Icons

Selecting the Text Entry Mode

Text entry modes make it easy for you to enter names, numbers, and messages.

In the text entry screen, select  > **Entry Mode**, and then select one of the following modes:

- **Primary** – for entering alphanumeric characters
- **Numeric** – for entering numbers only
- **Symbol** – for entering symbols only
- **Secondary** – for entering alphanumeric characters. (This mode is optional and you have to add it to the list.)

In the text entry screen, you can also press  repeatedly to change to Primary, Numeric, Symbol, or Secondary (if you have set it up).

Adding Secondary to the List of Text Entry Modes

Secondary is convenient when you use one language, and sometimes wish to switch to another one.

This mode appears in the list only if you set it up first via

 > **Entry Setup**.

None is the default programming from factory and indicates no secondary entry mode is selected.

Selecting the Text Entry Method and Language

There are two text entry methods:

- **TAP** – Enter letters, numbers and symbols by pressing an Alphanumeric key one or more times.

- **iTAP** – Let the terminal predict each word as you press an Alphanumeric key.

You can use these methods in the languages programmed in the terminal.

In the text entry screen, select **MENU** > **Entry Setup**, and then change to one of the methods and its related language (for example: TAP English).

Text Capitalisation

Press **0+↕**.











Icons

In the text entry screen, icons tell you which text entry mode and method you are using. A character counter icon indicates the number of entered characters.



| Primary Icons | Secondary Icons | Description |
|---------------|-----------------|------------------------------------|
| abc 1 | abc 2 | TAP – no capitals |
| Abc 1↑ | Abc 2↑ | TAP – capitalise next letter only |
| ABC 1↑ | ABC 2↑ | TAP – all capitals |
| abc □ | abc □ | iTAP – no capitals |
| Abc □↑ | Abc □↑ | iTAP – capitalise next letter only |
| ABC □↑ | ABC □↑ | iTAP – all capitals |

| Numeric Icon | Description |
|---------------|--------------------------------|
| 123 | Enter numbers. |
| Symbolic Icon | Description |
| @ | Enter punctuation and symbols. |

List of Keys and Characters in Alphanumeric Mode (TAP/iTAP)

| Key | Alphanumeric Mode (TAP/iTAP) |
|---|---|
|  | Press to cycle through single shift, caps lock, and lower case. |
|  | ., ? ! 0 1 @ ' " - () / : _ ; + & % * * = < > € £ \$ ¥ ¢ [] { } \ ~ ^ ` ¡ ¢ § # |
|  | A B C 2 a b c 2 |
|  | D E F 3 d e f 3 |
|  | G H I 4 g h i 4 |
|  | J K L 5 j k l 5 |
|  | M N O 6 m n o 6 |
|  | P Q R S 7 p q r s 7 |
|  | T U V 8 t u v 8 |
|  | W X Y Z 9 w x y z 9 |

List of Keys and Characters in Numeric Mode

| Key | Numeric Mode |
|--|--|
|  to  | <ul style="list-style-type: none"> • Press to enter digit at insertion point. • Press and hold any numeric key to enter TAP alphanumeric mode. • To exit TAP alphanumeric mode, press and hold any numeric key. |

Getting Started

Battery

Installing the Battery

1. Remove the battery from its protective clear plastic case.
2. Insert the battery top into the compartment as illustrated.
3. Carefully press the battery bottom downward until it clicks into place.

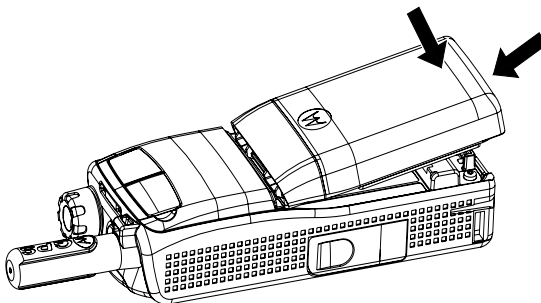

Replacing the Battery

1. To remove the battery, push the latch on the bottom.
2. Lift the bottom of the battery out.
3. Replace the battery.

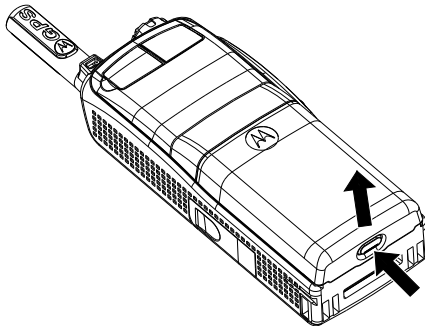

Charging the Battery

Motorola approved chargers provide optimum performance. Other chargers may not fully charge your Motorola Lithium-Ion battery or may reduce the life of the battery.

The MTP850 can be either **On** or **Off** during charging.

1. Insert the connector on the charger into the socket at the base of the MTP850. Select the required plug adapter (UK or European type) and connect to the charger. Then plug the charger into a suitable mains socket.
2. The MTP850 displays the **Charger Connected** message only if the MTP850 is **On** when connecting the charger. If the MTP850 is **Off**, the display shows an icon of the battery in charging.

The Battery icon shows the charging status (see below).



Empty



Full



Empty



Full

Battery Capacity

Battery Charge Progress

Battery Capacity Information

| Information | Description |
|----------------------------|------------------------------|
| Green icon | Full (50% – 100% capacity) |
| Yellow icon | Middle (20% – 50% capacity) |
| Red icon | Low (10% – 20% capacity) |
| Empty icon | Very low (5% – 10% capacity) |
| Low battery message | Less than 5% capacity |

Attaching the Antenna

NOTE Turn the MTP850 Off before installing or removing the antenna.

Insert the bottom of the antenna into the screw-in base on the top of the MTP850. Turn clockwise until snug. **Do not force.**

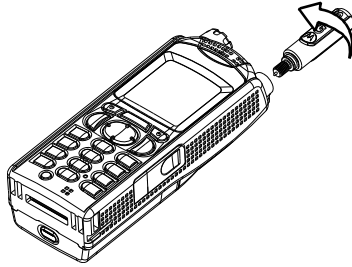

Powering On/Off (On-Off/End/Home Key)

To power **On**, press and hold . Your MTP850 performs a self-check and registration routine. After successful registration, the MTP850 is in service.

To power **Off**, press and hold . You will hear a beep and the **Powering Off** message is displayed.

Powering On (Emergency Button)

Press and hold the Emergency button to power **On**. The MTP850 will power **On** in Emergency Mode or in standard mode (as programmed).

Powering On with Transmit Inhibit (TXI) Active

Transmit Inhibit is a feature allowing you to switch off transmission before entering a Radio Frequency (RF) sensitive area. To activate this feature, press  and select **More... > Networks > TXI Mode > Activate**.



WARNING

*Pressing the Emergency button, even if Transmit Inhibit is activated, causes the MTP850 to transmit immediately. The MTP850 must **NOT** be within the RF sensitive area when entering Emergency Mode.*

The TXI Mode remains active at power **On**. You will be asked whether to leave the TXI Mode **On** or not.



WARNING

Ensure you have left the RF sensitive area before deactivating Transmit Inhibit.

Press the **Yes** soft key to deactivate the TXI Mode. If the MTP850 was previously used in Trunked Mode, it will register to the network. If the MTP850 was previously used in Direct Mode, it will remain in Direct Mode.

Press **No** in Trunked Mode and the MTP850 powers down; press **No** in Direct Mode and you remain in Direct Mode with TXI selected.

Unlocking the MTP850

Your MTP850 may be locked at power up.

To unlock the MTP850 after powering on, enter the code at the prompt. The MTP850 enters the default Home display.

The unlock code is originally set to 0000. Your Service Provider may change this number before you receive your terminal.

Locking/Unlocking the Keypad

To prevent accidental key/button presses:

Press **MENU** *** <** to lock the keypad. Press again **MENU** *** <** to unlock. Service Provider can choose the notification for the Keypad lock and if to lock the **PTT**.

Keypad Lock Notification

When the keypad is locked one of the following instructions is displayed:

- None – no notification is display.
- Notification Only – **Keys Locked** is displayed.



Notification and Instruction – **Keys Locked, Press Menu and * to lock/unlock** is displayed.

Automatic Keypad Lock

This feature locks the keypad automatically after not using it for a predefined time. To turn it on/off or to set the delay go to **Menu > Security > Keypad Lock Setup**.

Keypad Lock on Startup

The user can set the Keylock at the start up of the terminal. To turn it on / off go to **Menu > Security > Keylock > Start Locked**.

NOTE When there is an incoming call and the keypad with **PTT** are locked, you can still use the **PTT**, Rotary knob, , , and .

NOTE The Emergency button is not locked. Pressing the Emergency button unlocks the keypad.

Radio User Identity (RUI)

Your MTP850 needs to confirm RUI to provide the full service. After powering on you are prompted to input your **User ID** and **User PIN**.

To **Log on** press  > **More...** > **RUI** > **Log on**

To **Log off** press  > **More...** > **RUI** > **Log off**

If the Log on is not successful radio has limited access which is specified by the Service Provider.

NOTE Radio with RUI feature disabled provides the full service to the user without login prompt.

NOTE All the time the display indicates if the user is logged on (blue color of the icon) or logged off (grey color of the icon).

Selecting TMO or DMO Operation

Entering TMO or DMO

Enter TMO or DMO in one of the following ways:

- From the Home display press **Optns** and select **Direct Mode** if the MTP850 is in TMO.
- From the Home display press **Optns** and select **Trunked Mode** if the MTP850 is in DMO.
- Press **MENU** and select **More... > Networks > Trunked Mode** if the MTP850 is in DMO.
- Press **MENU** and select **More... > Networks > Direct Mode** if the MTP850 is in TMO.
- Press the TMO/DMO one-touch button (if programmed by your Service Provider).

You can make and receive the following types of calls when the MTP850 operates in Trunked Mode:

- Group Calls
- Private Calls
- Phone Calls
- PABX Calls – local (office) extension calls
- Emergency Calls
- Emergency Private Calls.

You can make and receive Group and Private Calls when the MTP850 operates in Direct Mode. This includes Emergency Group Calls.

The MTP850 returns to the Home display when there is no activity for a few seconds.

NOTE *Your terminal can alert you of an incoming call. Select the alert settings in the Vibrate menu and Tones menu items.*

Group Calls

A Group Call is a communication between you and others in a group. A group is a pre-defined set of subscribers enabled to participate in and/or invoke a Group Call.

Groups are organized in maximum three folders. Each folder may contain folders and several groups.

Favorite Folders

You can organise your favorite groups into three folders.

Selecting the “My Groups” Folders

NOTE *Default name for the first favorite folder is “My Groups”.*

From the Home display, press  to quickly access the folders.

Adding a Group (TMO/DMO)

1. Press  and select **More... > Group Setup > My Groups > <FolderName> > [New Group]**.
2. Select a group by alphabetic search (“**TMO/DMO by abc**”). Enter up to 12 characters of the group name. Or select a group by folder search (“**TMO/DMO by Folder**”). Select the folder and select the group. The group is added to the “My Groups” folder.

Deleting a Group (TMO/DMO)

1. Press  and select **More... > Group Setup > My Groups > <FolderName>**.
2. Highlight talkgroup name that you want to delete and select **Delete**.

NOTE *To delete all the groups press  and select **Delete All**. This option is available only if the Service Provider enables it.*

3. Press **Yes** to confirm.

Renaming Favorite Folder

1. Press **MENU** and select **More... > Group Setup > My Groups**.
2. Highlight a group folder name and press **MENU**.
3. Select **Rename Folder**.
4. After editing the name of the folder press **Ok** to confirm.

Deleting Favorite Folder

1. Press **MENU** and select **More... > Group Setup > My Groups**.
2. Highlight a group folder name and press **MENU**.
3. Select **Delete Folder**.
4. Press **Yes** to confirm.

NOTE

You cannot delete the last favorite folder.

Selecting a Group

NOTE

When you navigate in the Favorite folders and select a DMO group, your terminal will switch between TMO and DMO (and vice-versa).

Using the Rotary Knob

(If programmed)

From the Home display, press shortly on the Rotary knob and rotate until the requested group appears.

Group selection occurs:

- After a time-out
- Or, by pressing **Select** (if configured by your Service Provider)

Using the Navigation Key

From the Home display, scroll left or right until the requested group appears. Then press **Select** to confirm selection.

Using Alphabetic Search

From the Home display, press **Optns**. Select a group by alphabetic search ("**TG by abc**"). Enter up to 12 characters of the group name.

Select the group.

NOTE

Even if the talkgroup exist in couple folders, alphabetic search displays it once.

Using Folder Search

From the Home display, press **Optns**. Select a group by folder search (“**TG by Folder**”). Select the folder and select the group.

Using the Numeric Keypad - Speed Dialing

From the Home display, you can dial a group by entering its speed number via the keypad. This feature is called Talkgroup Speed Dialing. The speed number is pre-configured in the terminal.

You can view a speed number attributed to a group, if it exists.

Viewing the speed number

1. From the Home display, press **Optns**.
2. Select **TG by Folder** and then appropriate folder name.
3. Press **MENU**.
4. Select **View** to view the talkgroup speed number.

In this example “82” is the speed number. Press **Back** to return to the attached group screen.

Using a speed number

1. Enter a number (for example: “82”).
2. Press **#**.
3. Press **Attach** to attach the new group, or press **PTT** to attach and call.

NOTE

Speed Number for the TMO and DMO groups can be the same. For example if you are in TMO mode all the speed numbers from this mode are going to work.

Selecting a Folder

From the Home display, press **Optns**. Select **Folder**, and select the desired folder. The display shows the last selected group in that folder.

TMO Group Calls

In TMO the MTP850 is used with your Service Provider’s infrastructure.

Making a TMO Group Call

1. From the Home display and if this is the required group, press and hold the **PTT**.
2. Wait for the talk permit tone and then speak into the microphone. Release the **PTT** button to listen.

When you start a call, all members of the selected group who have their units turned on, will receive the Group Call.

NOTE

If you are in an on-going Group Call and wish to make a new call, press  to ignore the current call. Start the new call.

NOTE

*The **No Group** message is displayed when you are out of the normal coverage area of your selected group. You must then select a new group that is valid for your working location.*

Receiving a TMO Group Call

Unless it is engaged in a call, your MTP850 will receive the Group Call. To answer the call, press and hold **PTT**.

Your MTP850 shows the group name and the caller's private number or alias if previously stored in your contact list.

Receiving a TMO Broadcast Call

The Broadcast Call (also called Site Wide Call) is a high-priority Group Call from the console operator (or dispatcher) to all users. The MTP850s are configured to monitor a Broadcast Call, but users cannot talk back.

The Broadcast Call pre-empts an on-going Group Call that has the same (or lower) call priority.

PTT Double Push

This feature, if enabled by your Service Provider, allows you to send the tone when the radio is in idle or Group Call mode by pressing PTT twice. After the D-PTT tone is played, the user can press and hold the PTT once again to get the permission to talk.

To change the tone, press  > **Setup** > **Tones** > **D-PTT** > **Tone Style** and choose **Single**, **Double** or **Triple**. Please go to "Audio Signal Tones" on page 8 to view the specification of the tones.

To turn on/off this feature, press **MENU** > **Setup** > **Tones** > **D-PTT Tones** > **D-PTT Mode**.

DMO Group Calls

In DMO the MTP850 can be used without your Service Provider's infrastructure.

DMO allows communication with other terminals also operating in DMO, which are on the same frequency and group as your MTP850.

NOTE *In DMO it is only possible to place the following call types: Group Calls, Emergency Group Calls, Private and Private Simplex Calls.*

When you start a call, the members of the selected group who have their units turned on will receive the Group Call.

In DMO the MTP850 can communicate with the trunking system (and vice-versa) if the Gateway option is enabled in the MTP850.

Making a DMO Group Call

1. Enter **Direct Mode** by pressing **Optns** and selecting **Direct Mode**.
2. Make sure that you have selected the required group. Press and hold the **PTT** button.
3. Wait for the talk permit tone and then speak into the microphone. Release the **PTT** button to listen.

Receiving a DMO Group Call

You can receive a DMO Group Call only when your MTP850 is in DMO.

Unless it is engaged in a call, your MTP850 will receive the Group Call. To answer the call, press and hold **PTT**.

Your MTP850 shows the group name and the caller's private number or alias if previously stored in your contact list.

Exiting DMO





To exit DMO, press **Optns** and select **Trunked Mode**.

Private, Phone, and PABX Calls

NOTE

If you are in an on-going Group Call wish to make a new call, press  to ignore the current call. Dial the number.

Creating a Contact

1. From the Home display, press **Contcs**. Select [New Contact].
2. Enter name. Press **Ok** to confirm.
3. Press  /  and select the type of stored number (such as Private).
OR
 - Press **Change**, the display shows 6 type selections.
 - Press  /  to choose a type of stored number.
 - Press **Select**, the display returns to Contact Details screen.
4. Enter number (#). Press **Ok**.
5. Continue to enter other types and numbers, as you may keep several numbers (Private, Mobile, Home, Work, PABX, Other) for the same person under the same contact name.
6. When finished, press **Done**. Press **Back** to return to Home display.





How to Dial

Dialing a Number

1. From the Home display dial a number.
2. Press **CType** repeatedly to select the call type (Private, Phone, or PABX).
3. Press **PTT** or  depending on the call type.



Dialing via the Contact List

You can also use the contact list to select a number you previously stored. Press **Contcs** and search the stored number by scrolling

( or ) or by entering up to 12 characters of the contact name using alphabetic search. If the contact has more than one number, use  /  to select the number.

Speed Dial

Speed dial allows you to dial a shortened number of up to three digits instead of the full number. The speed dial number is the location of an entry in the contact list.

1. Enter the pre-programmed speed dial number (for example: 5) and press .
2. To place the call, press .

To hang up, press .

Private Call

A Private Call, also called Point-to-Point or individual call, is a call between two individuals. No other terminal can hear the conversation. This call can be:

- a Duplex call (if the system allows) in TMO, or
- a standard Simplex call in TMO or DMO.



Making a Private Call

1. From the Home display dial a number.
2. If Private is not the first type of call presented, press **CType** to select the Private Call type.
3. For a *Simplex* call, press and release the **PTT** button. You will hear a ringing tone. Wait for the called person to answer your call. Press and hold **PTT**. Wait for the talk permit tone (if configured) before talking, and release the **PTT** when listening.
For a *Duplex* call, press and release . You will hear a ringing tone. Wait for the called person to answer your call.

4. To end the call, press . If the called person ends the call, the **Call Ended** message is displayed.

NOTE *While Transmit Inhibit is activated, an incoming Private Call is indicated, but you cannot answer the call.*

Receiving a Private Call

1. The MTP850 switches to the incoming Private Call. The display shows the caller's identity.
2. To answer an incoming *Simplex* call, press **PTT**. To answer an incoming *Duplex* call (indicated by **Spkr/Erpc** soft keys), press  or green receiver button.
3. To end the call, press .

NOTE *Your terminal can alert you of an incoming call. Select the alert settings in the Vibrate menu and Tones menu items.*

Phone and PABX Calls

The **Phone Call** allows you to call a landline telephone number, a cellular mobile phone number or another terminal using ISDN number.

NOTE *Feature MS-ISDN enables the terminal to make and receive the calls from the phone using ISDN number.*

The **Private Automatic Branch Exchange (PABX) Call** allows you to call local (office) extension numbers. This type of call needs to be activated by your Service Provider.

In this publication we use "phone number" when referring to these numbers.

NOTE *While Transmit Inhibit is activated, an incoming Phone or PABX Call is indicated, but you cannot answer the call.*

Making a Phone or PABX Call

1. From the Home display dial a number.
2. If Phone or PABX are not the first type of call presented, press **CType** repeatedly to select the Phone or PABX call type.
3. Proceed as for making and receiving Duplex Private Calls..
If the user presses the PTT button it initiates a Simplex Phone Call.

Emergency Mode

You can send and receive **Emergency Group Calls** in **Trunked Mode** or in **Direct Mode**. If your terminal is configured to operate through a gateway, Emergency calls can be placed through the gateway.

You can initiate an Emergency Group Call to and receive it from:

- selected group (TMO and DMO) (if tactical emergency)
- pre-defined group (if non-tactical emergency).

Contact your Service Provider to know which is the selected mode.

Your Service Provider will configure the Emergency Alarm and Hot Microphone features.

Emergency calls will be allocated emergency priority in the system.

Entering or Exiting Emergency Mode

To enter Emergency Mode, press **and hold** the Emergency button at the top of the MTP850.

NOTE *The required time you need to press the Emergency button is set to default to 0.5 seconds. The time can be configured by your Service Provider.*

NOTE *Pressing the Emergency button activates one or more services. Contact your Service Provider for more information.*

To exit Emergency Mode, press and hold **Exit**. Your terminal will switch to the Home display.

Sending an Emergency Alarm

Your MTP850 will send an Emergency Alarm to the dispatcher (if configured by your Service Provider):

- Automatically, upon entering Emergency Mode.
- If you press the Emergency button again while the MTP850 is in Emergency Mode.

After sending the alarm, the display will show one of the following delivery reports:

- **Alarm Sent**
- **Alarm Failed**

In both cases, the display returns within a few seconds to the main screen of the Emergency Mode.

Due to no delivery confirmation in DMO, **Alarm Sent** information confirms only sending the alarm.



WARNING

*Pressing the Emergency button, even if Transmit Inhibit is activated, causes the MTP850 to transmit immediately. The MTP850 must **NOT** be within the RF sensitive area when entering Emergency Mode.*

NOTE

The Emergency Alarm is a special status message sent to the dispatcher monitoring the selected group. This can be used in dispatch systems to highlight emergency calls.

NOTE

Some systems do not support the Emergency Alarm feature when the user is in a "Local Area Service" area.

Hot Microphone Feature

If the Hot Microphone feature was programmed into your MTP850 by your Service Provider, you can make an Emergency Group Call and talk to the dispatcher (and members of your group) without the need to press and hold the **PTT**.

The microphone will stay open for a time period (programmed by your Service Provider). The microphone will stay open until:

- the Hot microphone time period expires
- you press **PTT** during the Hot Microphone period
- you press the **End** key

At the end of the Hot Microphone the **Emgcy Mic Ended** message will be displayed and the MTP850 returns to the Emergency Mode. The Hot Microphone feature is disabled and PTT operation returns to normal.

If required you can resume Hot Microphone by pressing the Emergency button again. Also your Service Provider is able to resume Hot Mic without user interaction by setting Alternating Hot Mic feature.

NOTE

Hot Microphone feature is available in DMO and TMO mode.

Making an Emergency Group Call

- Hot Microphone enabled – to initiate an Emergency Group Call, press and hold **Emergency Button**.
- Hot Microphone disabled – to initiate an Emergency Group Call, press and hold **Emergency Button**. When the display has changed to Emergency Group Call hold **PTT** and wait for talk permit tone (if configured) and talk. Release the PTT to be able to listen.

Silent Emergency Mode

NOTE *Silent Emergency Mode needs to be enabled by the Service Provider to be able to use it.*

To enter Silent Emergency Mode, press **Emergency button**.

Silent Emergency Mode provides no audible and visible indication. All of the key tones are switched off.

To exit Silent Emergency Mode, press **1-*/@** and **3 def** key simultaneously or **MENU** and then **#** key within 3 seconds.

Man Down

You can enable the Man Down feature in case of entering any risky operation. It monitors the state in which the terminal is. The terminal alerts you when:

- Its tilt exceeds a predefined angle value.
- It remains static for a predefined period of time.

Press **MENU** and select **Man Down > On**. To disable the feature, press **MENU** and select **Man Down > Off**.

NOTE *Additional audible and visual indications are available if enabled by your Service Provider.*

Call-Out

This feature allows the user to receive Call-Out alerts. When the Call-Out messages has been received by the radio, it interrupts current services and attends to the Call-Out alert without any further delay. After Call-Out alert has been cleared, the radio exits Call-Out mode and reverts back to normal mode. User is able only to receive Emergency Calls during Call-Out mode. There are four types of the Call-Out alert:

- Normal Call-Out
- Storm plan – it is sent to a group several time to raise reliability. User can only accept the Call-Out by pressing any button and is moved to information phase (soft keys are not labelled).
- Fallback Mode – it includes only voice communication. It can be cleared manually

NOTE *Fallback is only possible when Radio is in Local Site Trunking.*

- Test Call-Out – dispatcher has the ability to test this feature. Radio is generating the tone with **Call-Out Test** on the display. Only one softkey is enabled **Test OK** to confirm and to clear the test.

Interactions when the user is in other mode

- TXI Mode – users can read the message but they can not respond to it. They have an option to leave the TXI Mode by pressing soft key or reject the Call-Out message.
- DMO Mode – Call-Out is not supported.
- Emergency Mode – all the Call-out alert are ignored.

Call-Out service phases

- Alerting phase – user receives a Call-Out message. The alarm tone indicates the message text is displayed and under it there are three options for the user to pick: **Accept**, **Reject** or **MENU**. If the user will accept the alert no other service from this point can interrupt. **MENU** key gives more choices.

NOTE *The user can stop the alert tone by pressing PTT or any of the soft keys.*

- Information phase – user is still in the Call-Out mode and he can receive more detail information about the incident that occurred via subsequent text or the voice message. The user can query for more information using voice group call or Call-Out text function which enables the user to send a text message to the Service Provider. User can always respond and send back the text or the voice message using voice group call.

Call-Out Box

Call-Out Box is giving the user the option to view and store the Call-Out messages for future reference.

To view them press **MENU** > **Messages** > **CO Box**.

When the radio is in Call-Out Mode, you can only read the ongoing Call-Out messages.

Messages

Sending a Status Message

Select the desired group, then press **MENU** and select **Messages > Send Status**. Select status and press **OK** or **PTT**.

Sending a New Message

Press **MENU** and select **Messages > New Message**. Write your message. Select **Send**, or press **OK** or **PTT**. Select your mail recipient or enter number. Select **Send**, or press **OK** or **PTT** to send the new message.

NOTE *The message can be send to private, phone and a group number. Phone option needs to be enabled by your Service Provider.*

Sending a User-defined Message

Press **MENU** and select **Messages > Templates**. Scroll and choose your required template. Select **Send**, or press **OK** or **PTT**. Select your mail recipient or enter number. Select **Send**, or press **OK** or **PTT** to send the message.

Sending a Predefined Message

Press **MENU** and select **Messages > Predefined**. Scroll and choose your required template. Press **MENU** and select **Edit** to edit the message. Type required information. Select **Send**, or press **OK** or **PTT** to send the message.

Handling New Incoming Text Messages

Your MTP850 will alert you of an incoming message and enter the inbox automatically, if there is no on-going activity in the terminal. Scroll to the message and select **Read** soft key. To read a long message, press **More** to read the next page and **Back** to return to the previous page.

Then select **Reply**. Or press **MENU** and select to **Store / Delete / Delete All / Forward**.

NOTE *For Long Text Messages Reply, Store and Forward options are not available.*

Handling Unread (New) Messages

Press **MENU** and select **Messages > Inbox**. Scroll to the message and select **Read** soft key. To read a long message, press **More** to read the next page and **Back** to return to the previous page.

Press **MENU** and select to **Store / Delete / Delete All / Reply / Forward / Refresh**.

NOTE *Message contains up to 1000 characters.*

NOTE *It is possible to send the message to more than one user. Pick the group from the contact list on your MTP850.*

Tips & Tricks

Modeless Operation

No need to select a mode (Group / Private / Phone) before initiating a call. Just dial a number and press **CType** (call type) soft key to decide what call it is (then press **PTT** or ).

Home Key

Not sure where you are? Want to get back to Home display?



Press .

Backlight Control

You can either disable backlight (covert operation) or have it automatically turned on, by pressing any key. Third option is semi-auto, which means that only switching on the radio, pressing assigned button to the backlight feature and charging can trigger backlight.

The backlight remains on until the pre-programmed timer runs out.

Menu Shortcuts

- You can easily access any menu item, by pressing  and a Numeric key. (No delay between  and the key!)
- You can ask your Service Provider to program menu shortcuts.
- You may also define a new shortcut: enter the menu item, press and hold , and follow the instructions in the display.

High/Low Audio Control

You can control audio routing (speaker/earpiece/PHF) for any Private or Group Call via the dedicated Speaker Control key.

However, you can define via the menu to have all Group Calls in high audio ( > **Setup** > **Audio** > **Audio Toggle** > **Always Loud**).

NOTE *High/Low audio control is switched via One Touch Button. Contact your service provider for more information.*

Unified Contact List

You can keep several numbers (Private, Mobile, Home, Work, PABX, Other) for the same person under the same contact name. You can create up to 1000 contacts, and have a total of 1000 private numbers and 1000 phone numbers.

Text Size

You can see the text on the display in two sizes: **Standard** or **Zoomed** ( > **Setup > Display > Text Size**).

Group Capacity

Your Service provider can program up to 2048 groups for Trunked Mode, and up to 1024 groups for Direct Mode.

Flexible Folders

You can ask your Service Provider to define how many groups will be in each folder (up to 256 folders).

“My Groups” Folders

You can select any group (TMO or DMO) and add it to your personal folder.

In the Home display, press  to quickly access your “My Groups” folders.

Options (in the Home Display)

You can easily change folder, select groups, switch between TMO and DMO (and vice-versa), and other functions via the Home display Options.

Easy Navigation while in Menu

When scrolling up/down menu items, try also right/left scrolling. (This will select the item or return to previous level.)

Flipped Display On/Off



When this feature is activated, the contents of the display are flipped upside down. This feature is particularly useful if you have to wear the MTP850 on the shoulder, belt, or lapel and at the same time wish to read the display upside down.

To activate/deactivate, press  and select **Setup > Display > Flip Display**. Or press and hold the pre-programmed one-touch button.

Dialed Call List – Quick Access

From the Home display press  to access the list of the last dialed calls.

Automatic Scrolling via Navigation Key



In a list press and hold  or  for automatic scrolling.

Recent Calls Menu – Quick Access

From the Home display press .

Setting Time & Date

Time and date are synchronized by the infrastructure. When not within the infrastructure signal range you can set the values manually.

- To set time press  and select **Setup > Time & Date > Set > Set Time**. Enter time using navigation key and/or numeric keypad.
- To set date press  and select **Setup > Time & Date > Set > Set Date**. Enter date using navigation key and/or numeric keypad.
- To automatically set date and time press  and select **Setup > Time & Date > System Update**. Pick one out of three options accordingly to your needs:
 - **Off** – System Update is turned off
 - **Time only** – time is updated
 - **Time & Offset** – the time is updated automatically according to the current time zone when user is in TMO mode. In DMO mode the radio is using its internal clock.

Template Names

User is able to give the title of the template by his preference. If no default name is given.

Toggling between Talkgroups

You can switch the last two talkgroups in any mode and between the modes. For example when you are in TMO and would like to switch to the last Talkgroup that was in DMO, press and hold One Touch Button. It works in both ways and in one mode. After powering off, the radio remembers your two last Talkgroups.



MTP850



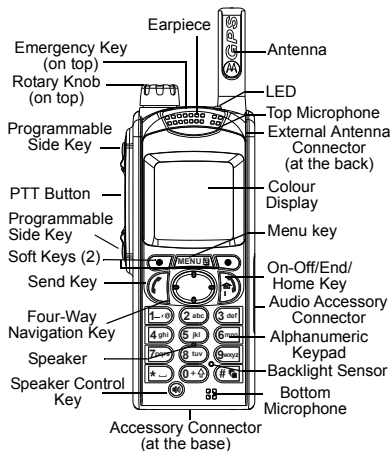



Quick Reference Guide



Turning the MTP850 On/Off

To power the MTP850 on/off, press and hold .

Using the MTP850 Menu System

- To enter the menu, press .
- To scroll through the menu, press  or .
- To select a menu item, press **Select** soft key or .
- To return to previous level, press **Back** or .
- To exit the menu items, press .

Selecting Trunked/Direct Mode Operation

- Your terminal may be configured with a One-touch button to switch between TMO/DMO. Contact your Service Provider for more information.
- From the Home display press **Optns.**, select **Trunked Mode** or **Direct Mode**.

Making a TMO Group Call

From the Home display navigate to the desired group. Press **Select** soft key (if configured). Press and hold **PTT**. Wait for the talk permit tone (if configured) and talk. Release **PTT** to listen.

Making a DMO Group Call

Enter DMO. Navigate to the desired group. Press **Select** soft key (if configured). Press and hold **PTT**. Wait for the talk permit tone (if configured) and talk. Release **PTT** to listen.

Making a TMO Emergency Group Call

Enter TMO. Press and hold the Emergency button. Emergency alarm is sent automatically. Press and hold **PTT**. Wait for the talk permit tone (if configured) and talk. Release **PTT** to listen. If using "Hot Mic" feature, wait for the **Emergency Mic On** message to appear on the display and talk without pressing **PTT**.

To exit Emergency Mode, press and hold **Exit** soft key.

Making a DMO Emergency Group Call

Enter DMO. Press and hold the Emergency button. Press and hold **PTT**. Wait for the talk permit tone (if configured) and talk. Release **PTT** to listen. To exit Emergency Mode press and hold **Exit** soft key.



Making a TMO Simplex Private Call

From the Home display dial a number. Press **CType** to select the call type. Press and release **PTT**. Ringing sounds. Called party answers. Wait for the called party to finish speaking. Press and hold **PTT**. Wait for the talk permit tone (if configured) and talk. Release **PTT** to listen. Press  to terminate call.

Making a DMO Simplex Private Call

Enter DMO. From the Home display dial a number. Press and hold **PTT**. Wait for the talk permit tone (if configured) and talk. Release **PTT** to listen. Press  to terminate call.



Making a Duplex Private Call/Phone/PABX Call

From the Home display dial a number. Press **CType** to select the call type. Press and release . Ringing sounds. Called party answers. Press  to terminate call.



Answering a Call

Your MTP850 switches to the incoming call and alerts you of the incoming call. To answer the call, press  for Phone/PABX/Duplex Private calls or press **PTT** for all other calls.

Sending a Status Message

Select the desired group, then press  and select **Messages > Send Status**. Select status and press  or **PTT**.

Sending a New Message

Press  and select **Messages > New Message**. Write your message. Select **Send**, or press  or **PTT**. Select your mail recipient or enter number. Select **Send**, or press  or **PTT** to send the new message.

Tips & Tricks

• Home Key



Not sure where you are? Want to get back to Home display? Press .

• Backlight Control

You can disable backlight (covert operation), have it automatically turned on by any key pressed or Semi Auto which turns on the radio by charging and pressing assigned button.

You can also press the upper Side key - just to turn On/Off the backlight (if configured).

• Menu Shortcuts

You can easily access any menu item, by pressing  and a numeric key. (No delay between  and the key!)

You can ask your Service Provider to program menu shortcuts.

You may also define a new shortcut: enter the menu item, press and hold , and follow the instructions in the display.

• High/Low Audio Control

You can control audio routing (speaker / earpiece/PHF) for any Private or Group Call via the dedicated speaker control key.

However, you can define via the menu to have all Group calls in high audio

( > Setup > Audio > Audio Toggle).

• Unified Contact List

You can keep several numbers (Private, Mobile, Home, Work, PABX, Other) for the same person under the same contact name.

• Text Size

You can see the text on the display in two sizes: **Normal** or **Zoomed** ( > Setup > Display > Text Size).

• “My Groups” Folder

You can select any group (TMO or DMO) and add it to your personal folder.

In the Home display, press  to quickly access your “My Groups” folder.



EN



MOTOROLA

www.motorola.com/tetra

6801500027-D

