

**APX TWO-WAY RADIOS**

# **APX 8000XE Model 1.5 User Guide**

**OCTOBER 2024**

© 2024 Motorola Solutions, Inc. All Rights Reserved.



**MN002667A01-BB**

# Intellectual Property and Regulatory Notices

## Copyrights

The Motorola Solutions products described in this document may include copyrighted Motorola Solutions computer programs. Laws in the United States and other countries preserve for Motorola Solutions certain exclusive rights for copyrighted computer programs. Accordingly, any copyrighted Motorola Solutions computer programs contained in the Motorola Solutions products described in this document may not be copied or reproduced in any manner without the express written permission of Motorola Solutions.

No part of this document may be reproduced, transmitted, stored in a retrieval system, or translated into any language or computer language, in any form or by any means, without the prior written permission of Motorola Solutions, Inc.

## Trademarks

MOTOROLA, MOTO, MOTOROLA SOLUTIONS, and the Stylized M Logo are trademarks or registered trademarks of Motorola Trademark Holdings, LLC and are used under license. All other trademarks are the property of their respective owners.

## License Rights

The purchase of Motorola Solutions products shall not be deemed to grant either directly or by implication, estoppel or otherwise, any license under the copyrights, patents or patent applications of Motorola Solutions, except for the normal nonexclusive, royalty-free license to use that arises by operation of law in the sale of a product.

## Open Source Content

This product may contain Open Source software used under license. Refer to the product installation media for full Open Source Legal Notices and Attribution content.

## European Union (EU) and United Kingdom (UK) Waste of Electrical and Electronic Equipment (WEEE) Directive



The European Union's WEEE directive and the UK's WEEE regulation require that products sold into EU countries and the UK must have the crossed-out wheeled bin label on the product (or the package in some cases). As defined by the WEEE directive, this crossed-out wheeled bin label means that customers and end users in EU and UK countries should not dispose of electronic and electrical equipment or accessories in household waste.

Customers or end users in EU and UK countries should contact their local equipment supplier representative or service center for information about the waste collection system in their country.

## Disclaimer

Please note that certain features, facilities, and capabilities described in this document may not be applicable to or licensed for use on a specific system, or may be dependent upon the characteristics of a specific mobile subscriber unit or configuration of certain parameters. Please refer to your Motorola Solutions contact for further information.

© 2024 Motorola Solutions, Inc. All Rights Reserved

# Contents

|  |           |
|--|-----------|
| <b>Intellectual Property and Regulatory Notices</b> .....      | <b>2</b>  |
| <b>List of Tables</b> .....                                    | <b>9</b>  |
| <b>Software Version</b> .....                                  | <b>10</b> |
| <b>Chapter 1: Read Me First</b> .....                          | <b>11</b> |
| 1.1 Notations Used in This Manual.....                         | 11        |
| 1.2 Radio Care.....  | 11        |
| 1.2.1 Cleaning Your Radio.....                                 | 12        |
| 1.2.2 Cleaning the External Surface of the Radio.....          | 12        |
| 1.2.3 Radio Service and Repair.....                            | 13        |
| 1.3 Battery Recycling and Disposal.....                        | 13        |
| 1.4 What Your Dealer or System Administrator Can Tell You..... | 13        |
| <b>Chapter 2: Getting Started</b> .....                        | <b>14</b> |
| 2.1 Charging the Battery.....                                  | 14        |
| 2.2 Attaching the Battery.....                                 | 14        |
| 2.3 Attaching the Antenna.....                                 | 15        |
| 2.4 Removing and Attaching the Accessory Connector Cover.....  | 15        |
| 2.5 Best Practice for Attaching an Accessory to the Radio..... | 16        |
| 2.6 Using the Carry Holder.....                                | 16        |
| 2.7 Attaching the Belt Clip.....                               | 16        |
| 2.8 Turning On the Radio.....                                  | 16        |
| 2.9 Adjusting the Volume.....                                  | 17        |
| <b>Chapter 3: Radio Controls</b> .....                         | <b>18</b> |
| 3.1 Radio Parts and Controls.....                              | 18        |
| 3.2 Programmable Features.....                                 | 19        |
| 3.2.1 Assignable Radio Functions.....                          | 20        |
| 3.2.2 Assignable Settings or Utility Functions.....            | 21        |
| <b>Chapter 4: Status Indicators</b> .....                      | <b>22</b> |
| 4.1 Battery Charge Status.....                                 | 22        |
| 4.1.1 Fuel Gauge Icons.....                                    | 22        |
| 4.1.2 HAZLOC Battery Type Detection.....                       | 23        |
| 4.2 LED Indications.....                                       | 23        |
| 4.3 Status Icons.....  | 24        |
| 4.4 Intelligent Lighting Indicators.....                       | 28        |
| 4.5 Alert Tones.....   | 29        |
| 4.6 Display Color Change On Channel.....                       | 32        |

|   |           |
|---|-----------|
| <b>Chapter 5: General Radio Operation.....</b>                          | <b>34</b> |
| 5.1 Selecting a Zone.....   | 34        |
| 5.2 Selecting a Radio Channel.....                                      | 34        |
| 5.3 Receiving and Responding to a Radio Call.....                       | 34        |
| 5.3.1 Receiving and Responding to a Talkgroup Call.....                 | 34        |
| 5.3.2 Receiving and Responding to a Private Call (Trunking Only).....   | 35        |
| 5.3.3 Receiving and Responding to a Telephone Call (Trunking Only)..... | 35        |
| 5.4 Methods to Make a Radio Call.....                                   | 35        |
| 5.4.1 Making a Talkgroup Call .....                                     | 36        |
| 5.4.2 Making a Private Call (Trunking Only).....                        | 36        |
| 5.4.3 Making an Enhanced Private Call (Trunking Only).....              | 36        |
| 5.5 Switching Between Repeater or Direct Operation Button.....          | 37        |
| 5.6 Monitor Feature.....  | 37        |
| 5.6.1 Monitoring a Channel.....   | 37        |
| 5.6.2 Monitoring Conventional Mode.....                                 | 38        |
| <b>Chapter 6: Additional Performance Enhancement.....</b>               | <b>39</b> |
| 6.1 ASTRO 25 Enhanced Data.....   | 39        |
| 6.2 Dynamic System Resilience.....                                      | 39        |
| 6.3 CrossTalk Prevention.....   | 39        |
| 6.4 Encrypted Integrated Data.....                                      | 39        |
| 6.5 SecureNet.....  | 39        |
| 6.6 Over-the-Air Rekeying.....  | 39        |
| 6.7 P25 Digital Vehicular Repeater System.....                          | 40        |
| 6.8 Conventional Talkgroup and Radio Scan Enhancements.....             | 40        |
| <b>Chapter 7: Advanced Features.....</b>                                | <b>41</b> |
| 7.1 ViQi.....   | 41        |
| 7.1.1 Using ViQi Virtual Partner.....                                   | 42        |
| 7.2 Advanced Call Features.....   | 42        |
| 7.2.1 Selective Call (ASTRO Conventional Only).....                     | 43        |
| 7.2.1.1 Receiving a Selective Call.....                                 | 43        |
| 7.2.1.2 Making a Selective Call.....                                    | 43        |
| 7.2.2 Making Priority Dispatch Calls.....                               | 43        |
| 7.2.3 Dynamic Regrouping (Trunking Only) .....                          | 44        |
| 7.2.3.1 Classification of Regrouped Radios.....                         | 44        |
| 7.2.3.2 Requesting a Reprogram (Trunking Only).....                     | 44        |
| 7.2.4 Multiple Private Line.....  | 45        |
| 7.2.4.1 Selecting Multiple Private Line.....                            | 45        |
| 7.3 Remote Monitor.....   | 45        |

|  |    |
|--|----|
| 7.4 Scan Lists.....  | 46 |
| 7.4.1 Intelligent Priority Scan.....                                 | 46 |
| 7.4.2 Viewing a Scan List.....                                       | 46 |
| 7.4.3 Viewing and Changing the Priority Status.....                  | 46 |
| 7.5 Scan.....  | 47 |
| 7.5.1 Turning Scan On or Off.....                                    | 47 |
| 7.5.2 Making a Dynamic Priority Change (Conventional Scan Only)..... | 47 |
| 7.5.3 Deleting a Nuisance Channel.....                               | 47 |
| 7.5.4 Restoring a Nuisance Channel.....                              | 48 |
| 7.6 Call Alert Paging.....   | 48 |
| 7.6.1 Receiving a Call Alert Page.....                               | 48 |
| 7.6.2 Sending a Call Alert Page.....                                 | 48 |
| 7.7 Recent Calls.....  | 49 |
| 7.7.1 Instant Recall.....  | 49 |
| 7.7.1.1 Saving and Playback Calls.....                               | 49 |
| 7.8 In-Call User Alert.....  | 50 |
| 7.9 Emergency Operation.....   | 50 |
| 7.9.1 Special Considerations for Emergency Operation.....            | 51 |
| 7.9.2 Emergency Keep-Alive.....                                      | 51 |
| 7.9.3 Exiting Emergency Operation.....                               | 51 |
| 7.9.4 Exiting Emergency as Supervisor (Trunking Only).....           | 51 |
| 7.9.5 Remote Emergency.....  | 52 |
| 7.9.5.1 Receiving Remote Emergency.....                              | 52 |
| 7.9.5.2 Filtering Remote Emergency Contacts.....                     | 52 |
| 7.9.6 Sending an Emergency Alarm.....                                | 53 |
| 7.9.7 Sending an Emergency Call (Trunking Only).....                 | 53 |
| 7.9.8 Sending An Emergency Call With Hot Mic (Trunking Only).....    | 53 |
| 7.9.9 Sending an Emergency Alarm with Emergency Call.....            | 54 |
| 7.9.10 Sending An Emergency Alarm and Call with Hot Mic.....         | 55 |
| 7.9.11 Sending a Silent Emergency Alarm.....                         | 55 |
| 7.9.12 Emergency Find Me.....  | 55 |
| 7.9.12.1 Receiving Emergency Beacons.....                            | 56 |
| 7.10 Fireground.....   | 56 |
| 7.10.1 Entering Fireground Zone Channel (Conventional).....          | 57 |
| 7.10.2 Responding to Evacuation Indicator.....                       | 57 |
| 7.11 Sending Evacuation Tone.....                                    | 58 |
| 7.12 Tactical Public Safety (Conventional Only).....                 | 58 |
| 7.12.1 Using TPS Normal Transmission.....                            | 58 |
| 7.12.2 Using TPS Emergency Transmission.....                         | 58 |

|  |    |
|--|----|
| 7.13 Fall Alert .....  | 59 |
| 7.13.1 Radio Alerts When Fall Alert is Triggered.....                              | 59 |
| 7.13.2 Testing Fall Alert.....   | 60 |
| 7.13.3 Exiting Fall Alert.....   | 60 |
| 7.13.4 Reinitiating Fall Alert.....  | 60 |
| 7.14 Secure Operations.....  | 60 |
| 7.14.1 Selecting Secure Transmissions.....   | 60 |
| 7.14.2 Selecting Clear Transmissions .....   | 61 |
| 7.14.3 Managing Encryption.....  | 61 |
| 7.14.3.1 Loading Encryption Keys.....  | 61 |
| 7.14.3.2 Multikey Feature.....   | 62 |
| 7.14.3.3 Erasing Encryption Keys.....  | 62 |
| 7.14.3.4 Requesting an Over-the-Air Rekey.....                                     | 62 |
| 7.14.3.5 MDC OTAR (Conventional Only).....   | 63 |
| 7.14.3.6 Infinite UKEK Retention.....  | 63 |
| 7.14.3.7 Hear Clear.....   | 63 |
| 7.15 Radio Inhibit.....  | 63 |
| 7.16 Location .....  | 64 |
| 7.16.1 Location Format.....  | 64 |
| 7.16.2 Location Feature in Emergency Mode.....                                     | 64 |
| 7.17 Mission Critical Geofence (ASTRO 25 Trunking).....                            | 65 |
| 7.17.1 Entering the Geofence Area.....   | 65 |
| 7.17.2 Mission Critical Geofence.....  | 66 |
| 7.17.3 Entering Mission Critical Geofence.....                                     | 66 |
| 7.17.4 Exiting Mission Critical Geofence.....                                      | 66 |
| 7.18 Trunking System Controls .....  | 67 |
| 7.18.1 Operating in Failsoft System.....   | 67 |
| 7.18.2 Imbalanced Coverage.....  | 67 |
| 7.18.3 Out-of-Range Radio.....   | 67 |
| 7.18.4 SmartConnect.....   | 67 |
| 7.18.5 Site Trunking Feature.....  | 68 |
| 7.18.6 Site Search.....  | 68 |
| 7.18.7 Locking and Unlocking a Site.....   | 68 |
| 7.18.8 Viewing the Current Site.....   | 69 |
| 7.18.9 Changing the Current Site.....  | 69 |
| 7.19 Mission Critical Wireless Bluetooth® Wireless Technology .....                | 69 |
| 7.19.1 Pairing with Low Frequency-Motorola Proximity Pairing (LF-MPP) Feature..... | 69 |
| 7.19.2 Responder Alert Sensors.....  | 70 |
| 7.19.2.1 Holster Sensor.....   | 70 |

|   |   |           |
|---|---|-----------|
| 7.19.2.2  | Weapon Fired Sensor.....                                      | 71        |
| 7.19.2.3  | Vest Pierced Sensor.....                                      | 71        |
| 7.19.2.4  | Disabling the Sensor.....                                     | 71        |
| 7.20  | ASTRO 25 (P25) Programming Over Project 25 (POP25).....       | 72        |
| 7.21  | Voice Announcement .....                                      | 72        |
| 7.22  | Site Selectable Alerts (ASTRO 25 Trunking) .....              | 73        |
| 7.23  | Wi-Fi.....  | 73        |
| 7.23.1  | Turning Wi-Fi On or Off.....                                  | 73        |
| 7.23.2  | Selecting WiFi Network.....                                   | 73        |
| 7.23.3  | Checking the Wi-Fi Configuration and Status of the Radio..... | 74        |
| 7.24  | Utilities.....  | 74        |
| 7.24.1  | Using the Flip Display.....                                   | 74        |
| 7.24.2  | Selecting a Basic Zone Bank.....                              | 74        |
| 7.24.3  | Selecting the Power Level.....                                | 75        |
| 7.24.4  | Controlling the Display Backlight.....                        | 75        |
| 7.24.5  | Locking and Unlocking the Keypad and Controls.....            | 75        |
| 7.24.6  | Turning Voice Mute On or Off.....                             | 76        |
| 7.24.7  | Using the Time-Out Timer.....                                 | 76        |
| 7.24.8  | Conventional Squelch Operation.....                           | 76        |
| 7.24.9  | Using the PL Defeat Feature.....                              | 77        |
| 7.24.10   | Digital PTT ID Support .....                                  | 77        |
| 7.24.11   | Smart PTT (Conventional Only).....                            | 78        |
| 7.24.12   | Transmit Inhibit.....   | 78        |
| 7.24.12.1   | Enabling Transmit Inhibition.....                             | 78        |
| 7.24.12.2   | Disabling Transmit Inhibition.....                            | 79        |
| <b>Chapter 8:</b>   | <b>Accessories.....</b>                                       | <b>80</b> |
| <b>Legal and Compliance Statements.....</b>               |   | <b>81</b> |
| Disclaimer.....   |   | 81        |
| Supplier's Declaration of Conformity.....                 |   | 81        |
| Important Safety Information.....                         |   | 82        |
| Notice to Users (FCC and ISED).....                       |   | 82        |
| FCC Licensing Information.....                            |   | 83        |
| Applying for Canadian License.....                        |   | 83        |
| <b>Maritime Radio Use in the VHF Frequency Range.....</b> |   | <b>84</b> |
| Special Channel Assignments.....                          |   | 84        |
| Emergency Channel.....                                    |   | 84        |
| Non-Commercial Call Channel.....                          |   | 84        |
| Operating Frequency Requirements.....                     |   | 84        |

Declaration of Compliance for the Use of Distress and Safety Frequencies..... 87

Technical Parameters for Interfacing External Data Sources..... 87

**Limited Warranty.....88**

MOTOROLA SOLUTIONS COMMUNICATION PRODUCTS.....88

I. WHAT THIS WARRANTY COVERS AND FOR HOW LONG:.....88

II. GENERAL PROVISIONS:..... 89

III. STATE LAW RIGHTS:.....89

IV. HOW TO GET WARRANTY SERVICE:.....89

V. WHAT THIS WARRANTY DOES NOT COVER:..... 89

VI. PATENT AND SOFTWARE PROVISIONS:.....90

VII. GOVERNING LAW:.....90

VIII. For Australia Only.....91



# List of Tables

|   |    |
|---|----|
| Table 1: LED Indications.....               | 23 |
| Table 2: ViQi Virtual Partner Queries.....  | 41 |
| Table 3: MPL Selection Mode.....            | 45 |
| Table 4: Emergency Operation Scenarios..... | 51 |
| Table 5: VHF Marine Channel List.....       | 85 |

# Software Version

All the features described in the following sections are supported by the software version **R34.00.00** or later.  
Contact your system administrator for more details of all the supported features.

## Chapter 1

# Read Me First

This User Guide covers the basic operation of the radio. However, your dealer or system administrator may have customized your radio for your specific needs. Check with your dealer or system administrator for more information.

### 1.1

## Notations Used in This Manual

Notations such as **Warning**, **Caution**, and **Notice** are used throughout the text in this publication. These notations are used to emphasize that safety hazards exist, and the care that must be taken or observed.



**WARNING:** An operational procedure, practice, or condition and so on, which may result in injury or death if not carefully observed.



**CAUTION:** An operational procedure, practice, or condition and so on, which may result in damage to the equipment if not carefully observed.



**NOTE:** An operational procedure, practice, or condition and so on, which is essential to emphasize.

### 1.2

## Radio Care

Proper radio usage and care ensure efficient operation and long-life of the product.



**CAUTION:** Use the radio according to the following recommendations and warnings.

- Your radio casing has a vent port for pressure equalization in the radio. Never poke this vent **A** with objects such as needles, tweezers, or screwdrivers. Poking the vent could create leak paths into the radio and the radio submersibility will be lost.

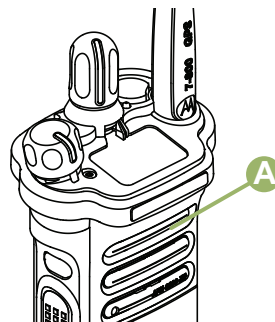

- Never obstruct or cover the vent port, even with a label.
- Ensure that no oily substances come in contact with the vent port.
- Your radio is designed to be submerged to a maximum depth of six feet and maximum time of two hours. Exceeding either maximum limit can result in damage to the radio.
- Elastomer seals used in portable radios age with time and environmental exposure. To ensure the waterseal integrity of the radio, Motorola Solutions recommends that radios be checked annually as a preventive measure. The disassembly, test, and reassembly procedures along with necessary test equipment are available in the *Service Manual*.

- If the radio battery contacts are exposed to water without the battery attached, dry and clean the radio battery contacts before attaching a battery to the radio. Turn the radio over with the battery contact facing down and shake the radio so any trapped water can escape. A short circuit of the contacts could occur if they are not dried properly.
- If the radio has been submerged in water, shake the radio to remove any water that is trapped inside the speaker grille and microphone port. Otherwise, the water decreases the audio quality of the radio.
- If an accessory is not attached to the radio, ensure that the accessory connector cover is attached to the radio side accessory connector.
- If the radio is submerged or exposed to a high force water spray, such as from a hose, remove the accessory or accessory connector cover immediately and ensure that no water is forced into the accessory connector or radio interface. Rinse and dry the area and reattach the accessory or accessory connector cover if leakage occurs.
- If the radio is exposed to a corrosive environment, such as salt water or corrosive gases or liquids, rinse, and clean the radio immediately to prevent damage to radio materials, especially plated surfaces. Remove the battery and the antenna before cleaning.
- Do **not** disassemble the radio as you could damage radio seals and result in leak paths into the radio. Any radio maintenance should be performed only by a qualified radio technician.
- Only Underwriter Laboratory (UL) approved service centers can open and service UL certified radios. Opening or repairing at unauthorized locations invalidates hazardous location rating of the radio.
- Do **not** pound, drop, or throw the radio unnecessarily.
- Turn off the radio when charging the radio using a wall-mounted charger. Otherwise, the Fall Alert and Emergency may be accidentally triggered.
- When cleaning the radio, do not use a high-pressure jet spray as this can exceed the depth pressure and cause water to leak into the radio.

### 1.2.1

## Cleaning Your Radio

To clean the external surfaces of your radio, perform the following:

#### Procedure:

1. Combine one teaspoon of mild dishwashing detergent to one gallon of water (0.5% solution).
2. Apply the solution sparingly with a stiff, non-metallic, shortbristled brush, making sure that excess detergent does not get entrapped near the connectors, controls, or crevices.
3. Rinse and then dry the radio thoroughly with a soft, lint-free cloth.
4. Clean battery contacts with a lint-free cloth to remove dirt or grease.

### 1.2.2

## Cleaning the External Surface of the Radio

#### Prerequisites:



**CAUTION:** Do **not** use solvents to clean your radio. Spirits may permanently damage the radio housing.

Do **not** submerge the radio in detergent solution.

#### Procedure:

1. Combine 1 teaspoon of mild dishwashing detergent to 1 gallon of water (0.5% solution).

2. Apply the solution sparingly with a stiff, non-metallic, short-bristled brush, ensuring that excess detergent does not get entrapped near the connectors, controls, or crevices.
3. Dry the radio thoroughly with a soft, absorbent, lint-free cloth.
4. Ensure that no water remains entrapped near the connectors, cracks, or crevices.

### 1.2.3

## Radio Service and Repair

Proper repair and maintenance procedures ensure efficient operation and long-life of this radio. A Motorola Solutions maintenance agreement provides expert service to keep the radio and all other communication equipment in perfect operating condition.

A nationwide service organization is provided by Motorola Solutions to support maintenance services. Through its maintenance and installation program, Motorola Solutions makes the finest service available to those desiring reliable continuous communications on a contract basis.

For a contract service agreement, contact your nearest Motorola Solutions service or sales representative, or an authorized Motorola Solutions dealer.

### 1.3

## Battery Recycling and Disposal

In the U.S. and Canada, Motorola Solutions participates in the nationwide Call2Recycle program for battery collection and recycling. Many retailers and dealers participate in this program.

For the location of the drop-off facility closest to you, go to <http://www.call2recycle.org/> or call 1-800-8-BATTERY. This website and telephone number also provide other useful information concerning recycling options for consumers, businesses, and governmental agencies.

### 1.4

## What Your Dealer or System Administrator Can Tell You

If the radio is to be operated in extreme temperatures (less than -30 °C or more than +60 °C), check with your system administrator for the correct radio settings.

You can consult your dealer or system administrator about the following:

- Is your radio programmed with any preset conventional channels?
- Which buttons have been programmed to access other features?
- What optional accessories may suit your needs?



**NOTE:** Specifications may vary for different radio models. For more information, contact your system administrator.

## Chapter 2

# Getting Started

This section provides instructions to prepare your radio for use.

## 2.1

### Charging the Battery

#### Prerequisites:



**WARNING:** To avoid a possible explosion:

- Do **not** replace the battery in any area labeled **hazardous atmosphere**.
- Do **not** discard batteries in a fire.

**When and where to use:** Motorola Solutions-approved battery shipped with your radio is uncharged. Prior to using a new battery, charge it for a minimum of 16 hours to ensure optimum capacity and performance. For a list of Motorola Solutions-authorized batteries and chargers available for use with your radio, see [Accessories on page 80](#).



**NOTE:** When charging a battery attached to a radio, the radio must be turned off.

#### Procedure:

To charge the battery, place the battery (with or without the radio) in a Motorola Solutions-approved charger.

The LED on the charger indicates the charging progress. For more information, see the *Charger User Guide*.

## 2.2

### Attaching the Battery

If your radio is preprogrammed with volatile-key retention, the encryption keys are retained for approximately 30 seconds after battery removal. Check with your dealer or system administrator for more information.

You can view the status of the battery if the radio is using an IMPRES 2 battery.



**NOTE:**

User is notified if radio detects non-Motorola Solutions battery upon powering up, charging, or removing from the charger. This feature is applicable for IMPRES and Non-IMPRES battery.

User is notified if radio detects non-Motorola Solutions battery upon powering up, charging, or removing from the charger. This feature is applicable for IMPRES 2 and Non-IMPRES battery.

When the radio is attached with the non-Motorola Solutions battery, a tone sounds, display shows `Unknown Battery` temporarily and battery indicator is not shown in the radio display. Battery menu screen displays `Unknown Battery` permanently and IMPRES battery information is not shown on the radio display.

When the radio is attached with the non-Motorola Solutions battery, a tone sounds, display shows `Unknown Battery` temporarily and battery indicator is not shown in the radio display. Battery menu screen displays `Unknown Battery` permanently and IMPRES 2 battery information is not shown on the radio display.

**Procedure:**

1. Slide the battery into the radio frame until the side latches click into place.
2. To remove the battery, turn the radio off. Squeeze the release latches at the bottom of the battery until the battery releases from the radio.

## 2.3

# Attaching the Antenna

**Prerequisites:** Ensure the radio is turned off before attaching the antenna.

**Procedure:**

1. Set the antenna in the receptacle.
2. Turn the antenna clockwise to attach to the radio.
3. To remove the antenna, turn the antenna counterclockwise.



**NOTE:** When removing the antenna, ensure that the radio is turned off.

## 2.4

# Removing and Attaching the Accessory Connector Cover

The accessory connector is on the antenna side of the radio. It is used to connect accessories to the radio.



**NOTE:** To prevent damage to the connector, shield it with the connector cover when not in use.

**Procedure:**

1. To remove the accessory connector cover, rotate the thumbscrew counterclockwise until it disengages from the radio.



**NOTE:** If the thumbscrew is too tight, use an allen wrench to loosen it.

2. Rotate and lift the connector cover to disengage it from the radio.

3. To attach the accessory connector cover, insert the hooked end of the cover into the slot above the connector.
4. Press the top of the cover downward to seat it in the slot.
5. Tighten by rotating the thumbscrew clockwise by hand.

## 2.5

# Best Practice for Attaching an Accessory to the Radio



**NOTE:** To ensure proper operation, turn off the radio before connecting an accessory to the radio.

### Procedure:

1. Attach an accessory connector to the side connector of the radio.
2. Secure the connection screw in a clockwise direction until tightened.

## 2.6

# Using the Carry Holder

### Procedure:

1. Position the radio within the carry holder with the main speaker facing outward.
2. Slide the radio down into the carry holder until it clicks in place.
3. To remove the radio from the carry holder, place the tip of your fingers on the ledge of the carry holder.
4. Push at the bottom of the radio until the radio is released from it.

## 2.7

# Attaching the Belt Clip

### Procedure:

1. Align the grooves of the belt clip with those of the radio and press upward until you hear a click.
2. To remove the clip, use a flat-bladed object to press the belt clip tab away from the radio.
3. Slide the clip downward and away from the radio to remove the clip.

## 2.8

# Turning On the Radio

### Procedure:

1. Rotate the **On/Off/Volume Control Knob** clockwise until you hear a click.
  - If the power-up test is successful, you see a splash screen on the radio display, followed by the Home screen and the Codeplug Alias.



- If the power-up test is unsuccessful, you see `Error XX/YY` (XX/YY is an alphanumeric code).



**NOTE:**

If the radio fails to power-up after repeating a few times, record the `Error XX/YY` code and contact your dealer.

Codeplug Alias feature is enabled through Customer Programming Software (CPS) configuration to display the codeplug alias as a temporary text during power on.

2. To turn off the radio, rotate the **On/Off/Volume Control Knob** counterclockwise until you hear a click.

## 2.9

# Adjusting the Volume

**Procedure:**

1. To increase the volume, rotate the **On/Off/Volume Control Knob** clockwise.
2. To decrease the volume, rotate the knob counterclockwise.

## Chapter 3

# Radio Controls

This chapter explains the buttons and functions to control the radio.

### 3.1

## Radio Parts and Controls

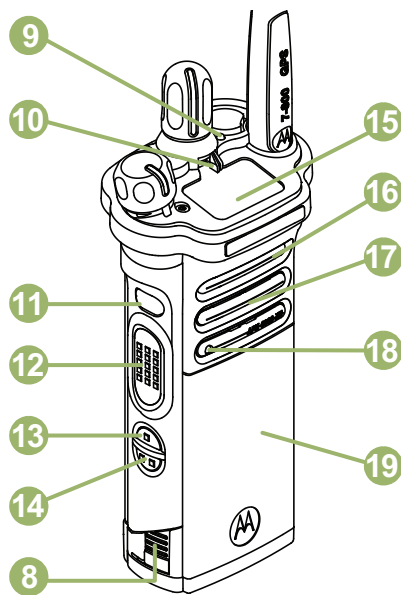
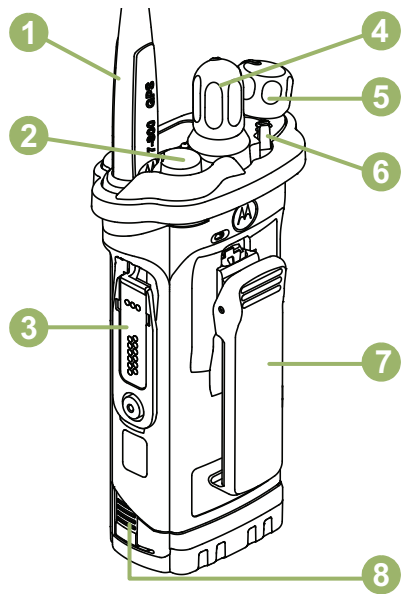

|   |         |
|---|---------|
| 1 | Antenna |
|---|---------|

|     |  |
|-----|--|
| 2*  | <b>Top (Orange) Button</b><br>This button is usually programmed as the <b>Emergency</b> button.  |
| 3   | Accessory Connector  |
| 4*  | <b>16-Position Select Knob</b><br>This knob is usually programmed for channel selection.   |
| 5   | <b>On/Off/Volume Control Knob</b><br>Rotate clockwise until you hear a click to turn on the radio.<br><br>Rotate counterclockwise until you hear a click to turn off the radio.<br><br>Rotate clockwise to increase the volume.<br><br>Rotate counterclockwise to decrease the volume. |
| 6*  | <b>3-Position A/B/C Switch</b><br>This switch is usually programmed for zone selection.  |
| 7   | Belt Clip  |
| 8   | Battery Latch  |
| 9   | LED Indicator  |
| 10* | <b>2-Position Concentric Switch</b><br>This switch is usually programmed to enable or disable secure operation.  |
| 11* | <b>Top Side (Select) Button</b><br>Use this programmable button to access a programmed function or enable or disable a feature.  |
| 12  | <b>Push-to-Talk (PTT) Button</b><br>Press and hold to talk in simplex calls or to initiate a group call, release it to listen.   |
| 13* | <b>Side Button 1</b><br>Use this programmable button to access a programmed function or enable or disable a feature.   |
| 14* | <b>Side Button 2</b><br>Use this programmable button to access a programmed function or enable or disable a feature.   |
| 15  | Top Display  |
| 16  | Microphone   |
| 17  | Main Speaker   |
| 18  | Bluetooth Pairing Location Indicator   |
| 19  | Battery  |

### 3.2

## Programmable Features

Your system administrator can program the programmable buttons as shortcuts to radio functions or preset channels/groups depending on the duration of a button press. Some functions can also be programmed to the radio switches.

---

\* These radio controls/buttons are programmable.

### 3.2.1

## Assignable Radio Functions

### **Bluetooth On/Off**

Toggles Bluetooth between on and off.

### **Bluetooth Audio Reroute**

Toggles the audio route between the radio speaker or the Remote Speaker Microphone and the Bluetooth headset.

### **Bluetooth Headset PTT**

Keys up the Bluetooth Headset microphone.

### **Bluetooth Clear All Pairing**

Clears all Bluetooth pairing information on your radio.

### **Bluetooth Inquiry On/Off**

Enables the Bluetooth Search feature.

### **Bluetooth Discoverable On/Off**

Enables the visibility of your radio to other Bluetooth devices.

### **Call Response**

Allows you to answer a private call.

### **Dynamic Priority (Conventional Only)**

Allows any channel in a Scan List (except for a Priority-One channel) to temporarily replace the Priority-Two channel.

### **Emergency**

Depending on the programming, initiates or cancels an emergency alarm or call.

### **In-Call User Alert**

Allows the radio to remain muted to affiliated talkgroup calls while operating on the current Trunking Personality or conventional channel.

### **Internet Protocol Address**

Displays the Internet Protocol (IP) address, device name, and status of the radio.

### **Fall Alert Clear**

Allows you to clear the Fall Alert mode alarm and exit Fall Alert feature.

### **Monitor (Conventional Only)**

Monitors a selected channel for all radio traffic until the function is disabled.

### **Nuisance Delete**

Temporarily removes an unwanted channel, except for priority channels and the designated transmit channel from the scan list.

### **Private Line Defeat (Conventional Only)**

Overrides any coded squelch (DPL or PL) that is preprogrammed to a channel.

### **Priority Dispatch**

Allows you to call the dispatcher on a different talkgroup.

### **Rekey Request**

Notifies the dispatcher that a new encryption key is needed.

### **Remote Monitor**

Enables the system administrator to remotely command a targeted radio.

### **Remote Emergency**

Activates the Remote Emergency feature for an authorized user to initiate the Emergency feature on a target radio without target user intervention.

**Repeater Access Button (RAB) (Conventional Only)**

Allows you to manually send a repeater access codeword.

**Reprogram Request (Trunking Only)**

Notifies the dispatcher that a new dynamic regrouping assignment is needed.

**Request-To-Talk (Conventional Only)**

Notifies the dispatcher that you want to send a voice call.

**Scan**

Short press – Toggles the scan function between on and off.

Long press – Enables Scan List Programming and selects the scan list for editing.

**Secure Transmission Select**

Toggles secure transmission between on and off.

**Site Display/Search (Trunking Only)**

Short press – Displays the current site ID and Received Signal Strength Indicator (RSSI) value.

Long press – Performs site search for Automatic Multiple Site Select (AMSS) or SmartZone operation (long press).

**Site Lock/Unlock (Trunking Only)**

Allows your radio to lock onto a specific site.

**Talkaround/Direct (Conventional Only)**

Toggles between using a repeater or communicating directly with another radio.

**Virtual Partner**

Enables the Virtual Partner feature and allows you to perform queries using ViQi.

**Basic Zone Bank**

Toggles between Basic Zone Bank 1 and Basic Zone Bank 2.

**Enhanced Zone Bank**

Provides access from up to 75 zones by toggling between 25 banks (A, B, ... X or Y) of three zones.

3.2.2

## Assignable Settings or Utility Functions

**Controls Lock**

Locks or unlocks the programmable buttons, switches, or rotary knobs.

**Light/Flip**

Press the button to toggle the display backlight on and off; press and hold the button to reverse the content of the top display.

**TX Power Level**

Toggles the transmit power level between high and low.

**Voice Announcement**

Audibly indicates the current feature mode, zone, or channel that you have been assigned to.

**Voice Mute**

Toggles the voice transmission between mute and unmute.

**Volume Set Tone**

Sets the volume set tone.

## Chapter 4

# Status Indicators

This section explains the status indicators of the radio.

### 4.1

## Battery Charge Status

Your radio indicates the battery charge status through LED, sounds, and the battery icon on the display. You can also check the battery charge status by using the menu entry.

Battery Protection is activated when the battery is low or operating in extremely low temperatures to extend radio communication. Features such as Wi-Fi and LTE are temporarily suspended.







When the Battery Protection Mode is active, you receive a notification. You can dismiss the Battery Protect Mode notification by tapping **Close** on the dialog box. The top display will switch between zones or channel information and Battery Protect Mode string.

Battery Protection Mode will end when the battery level or the temperature has returned to normal. A notification will appear on the front display indicating that LTE and Wi-Fi services have been restored. You can press **Close** to dismiss the notification or the dialog box will close itself after three minutes. The top display notification will also disappear.





### 4.1.1

## Fuel Gauge Icons

The fuel gauge icon indicates the battery level of your radio.

| Gauge  | Battery Charge                |
|--|-------------------------------|
| <br>Top Display:<br> | 76% to 100% full <sup>1</sup> |
| <br>Top Display:<br> | 51% to 75% <sup>1</sup>       |
| <br>Top Display:<br> | 26% to 50% <sup>1</sup>       |

<sup>1</sup> This is applicable for IMPRES 2 battery operation only.

| Gauge   | Battery Charge                                 |
|---|--|
| <br>Top Display: | 11% to 25% <sup>1</sup>                        |
| <br>Top Display: |  |
| <br>Top Display: | 10% or less (The gauge begins blinking at 10%) |
| <br>Top Display: |  |

#### 4.1.2

### HAZLOC Battery Type Detection

This feature alerts you when there is a HAZLOC certification mismatch between the radio and the battery. This feature supports IMPRES batteries only.

During power-up, the following scenarios occur if there is a mismatch:

- The radio continuously displays `Wrong Battery` with red intelligent backlight.
- The radio Voice Announcement announces the programmed `Wrong Battery`.
- The battery icon blinks continuously.
- A repetitive tone sounds.
- The red LED blinks continuously.



**NOTE:**

The radio alerts you when NNTN8921 and NNTN8930 batteries are attached to the radio because these batteries are not supported. The radio is not HAZLOC-certified and resets if these batteries are used. Refer to the radio FM or UL Manual for more information.

The radio does not display any indication when the radio is connected to the charger, the radio and battery match, or when the radio certification type is configured as **None** in Customer Programming Software (CPS).

This feature is enabled through CPS configuration. Check with your dealer or system administrator for more information.

#### 4.2

### LED Indications

The LED indications represent the operational status of your radio. A qualified technician can permanently disable the LED indication by programming it.

**Table 1: LED Indications**

| Indication   | Status  |
|--------------|---|
| Solid red    | Radio is transmitting.                          |
| Blinking red | Radio is transmitting at low battery condition. |

| Indication           | Status   |
|----------------------|--|
| Double blinking red  | Radio is transmitting an emergency alarm or call.  |
| Rapid blinking red   | Radio has failed the self-test upon powering up or encountered a fatal error.  |
| Solid yellow         | Radio is receiving in both trunking and conventional clear mode.<br> <b>NOTE:</b> The yellow LED illuminates only when the Busy LED feature is enabled through Customer Programming Software (CPS). |
| Blinking yellow      | Radio is receiving a secured transmission.   |
| Solid green          | Radio is powering up or is on a non-priority channel while in the Scan List Programming mode.  |
| Blinking green       | Radio is receiving an individual or telephone call or is on a Priority-Two channel while in the Scan List Programming mode.  |
| Rapid blinking green | Radio is on a Priority-One channel while in the Scan List Programming mode.  |









### 4.3

## Status Icons















The LCD display of your radio shows radio status, text entries, and menu entries. The top two display rows contain color icons that indicate radio operating conditions.









Selected icons are also shown on the first row of the 112 x 32 pixel top monochrome display screen of your radio.















The following icons are for the front display screen unless indicated otherwise.

| Icon  | Description   |
|---|---|
| <br>Top Display: | The radio is receiving a call or data.  |
| <br>Top Display: |   |
| <br>Top Display: | The radio is transmitting a call or data.   |
| <br>Top Display: |   |
|                  | The radio received an Individual Call.  |
| <br>Top Display: | For IMPRES 2 battery operation only – the icon shown indicates the charge remaining in the battery.   |
| <br>Top Display: | For all battery operation – the icon blinks when the battery is low.  |
| <br>Top Display: | The number of bars represents the received signal strength of the current site in trunking mode. The more stripes in the icon, the stronger the signal. |
|                  |   |



| Icon  | Description  |
|---|--|
| <br>Top Display:   | The radio has roamed to and is registered to a foreign system.   |
|                    |  |
| <br>Top Display:   | <b>Direct</b><br><b>On</b><br>The radio is configured for direct radio-to-radio communication in conventional operation.<br><b>Off</b><br>The radio is connected with other radios through a repeater. |
| <br>Top Display:   |  |
| <br>Top Display:   | The selected channel is being monitored in conventional operation.   |
|                    |  |
|                    | The In-Call User Alert feature is enabled. Voice muting of the affiliated trunking talkgroup or selected conventional channel is activated.  |
| <b>H</b><br>or<br><b>L</b><br>Top Display:  | The radio is set at High power.<br>The radio is set at Low power.  |
| <b>H</b><br>or<br><b>L</b>  |  |
| <br>Top Display: | The radio is scanning a scan list.   |
|                  |  |
| <br>Top Display: | <b>Blinking dot</b><br>The radio detects activity on the designated Priority-One channel.  |
| <br>Top Display: | <b>Steady dot</b><br>The radio detects activity on the designated Priority-Two channel.  |
| <br>Top Display: | <b>On steady</b><br>The radio is in View mode<br><b>Blinking</b><br>The radio is in Program mode.  |
| <br>Top Display: | The vote scan feature is enabled.  |
|                  |  |
| Top Display:  | Basic Zone Bank 1  |
|                  | <b>A</b><br>Radio is in Zone 1.  |

| Icon   | Description  |
|--|--|
|  | <p><b>B</b><br/>Radio is in Zone 2.</p> <p><b>C</b><br/>Radio is in Zone 3.</p>  |
| <p>Top Display:</p>   | <p>Basic Zone Bank 2</p> <p><b>D</b><br/>Radio is in Zone 4.</p> <p><b>E</b><br/>Radio is in Zone 5.</p> <p><b>F</b><br/>Radio is in Zone 6.</p>   |
| <p>Top Display:</p>  <p>until</p>  <p>or</p>  | <p>Enhanced Zone Bank</p> <p><b>A</b><br/>Contains Zone 1, Zone 2, and Zone 3,</p> <p><b>B</b><br/>Contains Zone 4, Zone 5, and Zone 6,</p> <p><b>C</b><br/>Contains Zone 7, Zone 8, and Zone 9,<br/>until</p> <p><b>X</b><br/>Contains Zone 70, Zone 71, and Zone 72,</p> <p><b>Y</b><br/>Contains Zone 73, Zone 74, and Zone 75.</p> |
| <p> Top Display:</p> <p></p>   | <p><b>On</b><br/>Secure operation.</p> <p><b>Off</b><br/>Clear operation.</p> <p><b>Blinking</b><br/>Receiving an encrypted voice call.</p>  |
| <p></p>   | <p><b>On</b><br/>The radio is operating in an Advanced Encryption Standard (AES) secure channel.</p> <p><b>Off</b><br/>The AES operation is cleared.</p> <p><b>Blinking</b><br/>The radio is receiving an AES-encrypted voice call.</p>  |
| <p></p>   | <p><b>On</b><br/>The Global Position System (GPS) feature is enabled, and the signal is available.</p> <p><b>Blinking</b><br/>The GPS feature is enabled, but no signal is available.</p>  |
| <p></p>   | <p>User Login Indicator (IP Packet Data)</p>   |

| Icon   | Description   |
|--|---|
|  | <p><b>On</b><br/>The user is associated with the radio.</p> <p><b>Blinking</b><br/>The device registration or user registration with the server failed due to an invalid username or pin.</p> <p><b>Inverted</b><br/>The user is logged on to the secured IP packet data.</p> |
|   | Data activity is present on the radio.  |
| <br>Top Display:<br> | The Bluetooth wireless technology is turned on and ready for connection.  |
| <br>Top Display:<br> | <p><b>Steady</b><br/>Bluetooth is connected to the external Bluetooth device.</p> <p><b>Blinking</b><br/>Bluetooth device is disconnected.</p>  |
|    | <p><b>Steady</b><br/>The broadband system is available and connected.</p> <p><b>Blinking</b><br/>The Automatic Registration Service (ARS) user login failed while in broadband system.</p>  |
|   | The radio is receiving the broadband signal.  |
|   | The radio is transmitting the broadband signal.   |
|   | The radio is receiving and transmitting the broadband signal.   |
|   | The ARS user logged on successfully with the broadband system.  |
|   | The radio is receiving a broadband signal with the ARS user logged on.  |
|   | The radio is transmitting a broadband signal with the ARS user logged on.   |
|   | The radio is receiving and transmitting broadband signals with the ARS user logged on.  |
|   | Your radio is connected to a Wi-Fi® network. The number of bars represents the signal strength of the Wi-Fi network.  |

| Icon | Description   |
|------|---|
| ))   | <b>On</b><br>The current channel is capable of supporting SmartConnect.                         |
|      | <b>Inverted</b><br>The current channel is currently connected through the SmartConnect feature. |

#### 4.4

## Intelligent Lighting Indicators

This feature temporarily changes the backlight of the top display screen to help signal that a radio event has occurred. This feature temporarily changes the backlight of the top display screen, and adds a color bar to the main display screen to help signal that a radio event has occurred. This feature temporarily changes the display backlight color and the alert text background color of the radio to help signal that a radio event has occurred.

| Backlight and Bar Color | Notification     | When  |
|-------------------------|------------------|---|
| Orange                  | Emergency Alerts | The radio initiates an emergency alarm or call.                     |
|                         |                  | The radio receives an emergency alarm or call.                      |
|                         |                  | The radio initiates the Fall Alert Post-Alert timer.                |
|                         |                  | The radio initiates Fireground Evacuation alarm.                    |
| Orange                  | Emergency Alerts | The radio initiates an emergency alarm or call.                     |
|                         |                  | The radio receives an emergency alarm or call.                      |
| Red                     | Critical Alerts  | The radio battery is low.   |
|                         |                  | The radio is out of range.  |
|                         |                  | The radio enters Failsoft mode.                                     |
|                         |                  | The radio is unable to establish a full connection with the system. |
| Red                     | Critical Alerts  | The radio is unable to authenticate or register with the system.    |
|                         |                  | The radio is out of range.  |
|                         |                  | The radio enters Failsoft mode.                                     |
|                         |                  | The radio is unable to establish a full connection with the system. |
| Green                   | Call Alerts      | The radio receives a private call.                                  |
|                         |                  | The radio receives a phone call.                                    |
|                         |                  | The radio receives a call alert.                                    |
|                         |                  | The radio receives a selective call.                                |
|                         |                  | The radio enters Geofence.  |

4.5

## Alert Tones

Your radio uses alert tones to inform you of the condition of your radio. The following table lists these tones and when they occur.

| You Hear                            | Tone Name                           | Heard  |
|-------------------------------------|-------------------------------------|--|
| <b>Short, Low-Pitched Tone</b>      | <b>Radio Self Test Fail</b>         | When radio fails its power-up self test.   |
|                                     | <b>Reject</b>                       | When an unauthorized request is made.  |
|                                     | <b>Time-Out Timer Warning</b>       | Four seconds before time out.  |
|                                     | <b>No ACK Received</b>              | When radio fails to receive an acknowledgment.   |
|                                     | <b>Individual Call Warning Tone</b> | When radio is in an individual call for greater than six seconds without any activity.   |
|                                     | <b>Fall Alert Entry</b>             | When radio initiates Fall Alert mode.  |
| <b>Long, Low-Pitched Tone</b>       | <b>Time-Out Timer Timed Out</b>     | After time out.  |
|                                     | <b>Talk Prohibit/PTT Inhibit</b>    | (When <b>PTT</b> button is pressed) transmissions are not allowed.   |
|                                     | <b>Lack of Voice PTT Time out</b>   | When the radio ends your call after it detected there is lack of voice for 60 seconds after the PTT is pressed and hold. Your radio ends the call to enable your radio to receive calls from other radio users. The duration of this timer can be preprogrammed by a qualified radio technician. |
|                                     | <b>Out of Range</b>                 | (When <b>PTT</b> button is pressed) the radio is out of range of the system.   |
|                                     | <b>Invalid Mode</b>                 | When radio is on an unpreprogrammed channel.   |
| <b>A Group of Low-Pitched Tones</b> | <b>Busy</b>                         | When system is busy.   |
| <b>Short, Medium-Pitched Tone</b>   | <b>Valid Key-Press</b>              | When a correct key is pressed.   |
|                                     | <b>Radio Self Test Pass</b>         | When radio passes its power-up self test.  |
|                                     | <b>Clear Voice</b>                  | At beginning of a non-coded communication.   |
|                                     | <b>Priority Channel Received</b>    | When activity on a priority channel is received.   |
|                                     | <b>Emergency Alarm/Call Entry</b>   | When entering the emergency state.   |
|                                     | <b>Central Echo</b>                 | When central controller has received a request from a radio.   |
| <b>Long, Medium-Pitched Tone</b>    | <b>Volume Set</b>                   | When volume is changed on a quiet channel.   |
|                                     | <b>Emergency Exit</b>               | When exiting the emergency state.  |
| <b>A Group of Medium-</b>           | <b>Failsoft</b>                     | When the trunking system fails.  |
|                                     | <b>Automatic Call Back</b>          | When voice channel is available from previous request.   |

| <b>You Hear</b>                           | <b>Tone Name</b>                           | <b>Heard</b>  |
|---|--|---|
| <b>Pitched Tones</b>                      | <b>Keyfail</b>                             | When encryption key has been lost.  |
|   | <b>Console Acknowledge</b>                 | When status, emergency alarm, or reprogram request ACK is received.   |
|   | <b>Received Individual Call</b>            | When Call Alert or Private Call is received.  |
|   | <b>Call Alert Sent</b>                     | When Call Alert is received by the target radio.  |
|   | <b>Site Trunking</b>                       | When a SmartZone trunking system fails.   |
| <b>Short, High-Pitched Tone (Chirp)</b>   | <b>Low-Battery Chirp</b>                   | When battery is below preset threshold value.   |
| <b>Two High-Pitched Tones</b>             | <b>GPS Fails</b>                           | When the GPS fails or loses signal.   |
| <b>Ringling</b>                           | <b>Fast Ringing</b>                        | When system is searching for target of Private Call.  |
|   | <b>Enhanced Call Sent</b>                  | When waiting for target of Private Call to answer the call.   |
|   | <b>Phone Call Received</b>                 | When a land-to-mobile phone call is received.   |
| <b>Gurgle</b>                             | <b>Dynamic Regrouping</b>                  | (When <b>PTT</b> button is pressed) a dynamic ID has been received.   |
|   | <b>Talk Permit</b>                         | (When <b>PTT</b> button is pressed) is verifying with the system for accepting its transmissions.                     |
| <b>Unique, Low-Pitched Chirp</b>          | <b>New Message</b>                         | When a new message is received.   |
| <b>Unique, High-Pitched Chirp</b>         | <b>Priority Status</b>                     | When a priority message is received.  |
| <b>Incremental-Pitched Tone</b>           | <b>Bluetooth Paired</b>                    | When Bluetooth accessory is paired with the radio.  |
|   | <b>Bluetooth Connected</b>                 | When Bluetooth accessory is connected to the radio.   |
| <b>Decremental-Pitched Tone</b>           | <b>Bluetooth Unpaired</b>                  | When Bluetooth accessory is unpaired from the radio.  |
|   | <b>Bluetooth Disconnected</b>              | When Bluetooth accessory is disconnected from the radio.  |
| <b>A Group of Very High-Pitched Tones</b> | <b>Fall Alert Continuous Tone</b>          | When radio is in Fall Alert mode and prepares to transmit Emergency Alarm when the timer of this alarm ends.          |
|   | <b>Critical Fall Alert Continuous Tone</b> | When radio is in Fall Alert Enhanced mode and prepares to transmit Emergency Alarm when the timer of this alarm ends. |
| <b>Unique Low-High Tone</b>               | <b>Enhanced Zone Bank Up</b>               | When <b>EZB Up</b> button is pressed to scroll the Enhance Zone Bank up.  |
| <b>Unique High-Low Tone</b>               | <b>Enhanced Zone Bank Down</b>             | When <b>EZB Down</b> button is pressed to scroll the Enhance Zone Bank down.  |

| <b>You Hear</b>                        | <b>Tone Name</b>                    | <b>Heard</b>   |
|--|-------------------------------------|--|
| <b>Short, Low-Pitched Tone</b>         | <b>Radio Self Test Fail</b>         | When radio fails its power-up self test.   |
|  | <b>Reject</b>                       | When an unauthorized request is made.  |
|  | <b>Time-Out Timer Warning</b>       | Four seconds before time out.  |
|  | <b>No ACK Received</b>              | When radio fails to receive an acknowledgment.   |
|  | <b>Individual Call Warning Tone</b> | When radio is in an individual call for greater than six seconds without any activity.   |
|  | <b>Fall Alert Entry</b>             | When radio initiates Fall Alert mode.  |
| <b>Long, Low-Pitched Tone</b>          | <b>Time-Out Timer Timed Out</b>     | After time out.  |
|  | <b>Talk Prohibit/PTT Inhibit</b>    | (When <b>PTT</b> button is pressed) transmissions are not allowed.   |
|  | <b>Lack of Voice PTT Time out</b>   | When the radio ends your call after it detected there are lack of voice for five seconds after the PTT is pressed and hold. Your radio ends the call to enable your radio to receive calls from other radio users. |
|  | <b>Out of Range</b>                 | (When <b>PTT</b> button is pressed) the radio is out of range of the system.   |
|  | <b>Invalid Mode</b>                 | When radio is on an unpreprogrammed channel.   |
| <b>A Group of Low-Pitched Tones</b>    | <b>Busy</b>                         | When system is busy.   |
| <b>Short, Medium-Pitched Tone</b>      | <b>Valid Key-Press</b>              | When a correct key is pressed.   |
|  | <b>Radio Self Test Pass</b>         | When radio passes its power-up self test.  |
|  | <b>Clear Voice</b>                  | At beginning of a non-coded communication.   |
|  | <b>Priority Channel Received</b>    | When activity on a priority channel is received.   |
|  | <b>Emergency Alarm/Call Entry</b>   | When entering the emergency state.   |
|  | <b>Central Echo</b>                 | When central controller has received a request from a radio.   |
| <b>Long, Medium-Pitched Tone</b>       | <b>Volume Set</b>                   | When volume is changed on a quiet channel.   |
|  | <b>Emergency Exit</b>               | When exiting the emergency state.  |
| <b>A Group of Medium-Pitched Tones</b> | <b>Failsoft</b>                     | When the trunking system fails.  |
|  | <b>Automatic Call Back</b>          | When voice channel is available from previous request.   |
|  | <b>Keyfail</b>                      | When encryption key has been lost.   |
|  | <b>Console Acknowledge</b>          | When status, emergency alarm, or reprogram request ACK is received.  |
|  | <b>Received Individual Call</b>     | When Call Alert or Private Call is received.   |
|  | <b>Site Trunking</b>                | When a SmartZone trunking system fails.  |

| You Hear                                  | Tone Name                                  | Heard   |
|---|--|---|
| <b>Short, High-Pitched Tone (Chirp)</b>   | <b>Low-Battery Chirp</b>                   | When battery is below preset threshold value.   |
| <b>Two High-Pitched Tones</b>             | <b>GPS Fails</b>                           | When the GPS fails or loses signal.   |
| <b>Ringling</b>                           | <b>Phone Call Received</b>                 | When a land-to-mobile phone call is received.   |
| <b>Gurgle</b>                             | <b>Dynamic Regrouping</b>                  | (When <b>PTT</b> button is pressed) a dynamic ID has been received.   |
|   | <b>Talk Permit</b>                         | (When <b>PTT</b> button is pressed) is verifying with the system for accepting its transmissions.                     |
| <b>Unique, Low-Pitched Chirp</b>          | <b>New Message</b>                         | When a new message is received.   |
| <b>Unique, High-Pitched Chirp</b>         | <b>Priority Status</b>                     | When a priority message is received.  |
| <b>Incremental-Pitched Tone</b>           | <b>Bluetooth Paired</b>                    | When Bluetooth accessory is paired with the radio.  |
|   | <b>Bluetooth Connected</b>                 | When Bluetooth accessory is connected to the radio.   |
| <b>Decremental-Pitched Tone</b>           | <b>Bluetooth Unpaired</b>                  | When Bluetooth accessory is unpaired from the radio.  |
|   | <b>Bluetooth Disconnected</b>              | When Bluetooth accessory is disconnected from the radio.  |
| <b>A Group of Very High-Pitched Tones</b> | <b>Fall Alert Continuous Tone</b>          | When radio is in Fall Alert mode and prepares to transmit Emergency Alarm when the timer of this alarm ends.          |
|   | <b>Critical Fall Alert Continuous Tone</b> | When radio is in Fall Alert Enhanced mode and prepares to transmit Emergency Alarm when the timer of this alarm ends. |
| <b>Unique Low-High Tone</b>               | <b>Enhanced Zone Bank Up</b>               | When <b>EZB Up</b> button is pressed to scroll the Enhance Zone Bank up.  |
| <b>Unique High-Low Tone</b>               | <b>Enhanced Zone Bank Down</b>             | When <b>EZB Down</b> button is pressed to scroll the Enhance Zone Bank down.  |

#### 4.6

## Display Color Change On Channel

This feature provides visual channel identification for users to have a quick visual recognition on a particular channel.

Your radio must be programmed to allow you to use this feature.

For Model 3.5 and Model 2.5, when changing channels, the radio backlight on top display, radio keypad, and accessories (DRSM or keypad Mic) changes to the programmed color.

The backlight on top display changes to white. If connected to accessories, the DRSM backlight changes to white and the keypad mic backlight changes to green for the following scenarios:



- When changing to or powering up on invalid channels such as unprogrammed channels, receiver frequency error channel and blank channels.
- The radio is in radio stun or radio lock mode.



**NOTE:** Radio stun or radio lock mode is only applicable to Model 3.5.

For hard key zeroize, key loading, and scan list programming, the backlight follows the home channel backlight color.

## Chapter 5

# General Radio Operation

This chapter explains the general operations of your radio.

## 5.1

### Selecting a Zone

**When and where to use:** A zone is a group of channels.

**Procedure:**

Select a zone using the preprogrammed **Zone (3-Position A/B/C)** switch:

- a. Move the preprogrammed **Zone (3-Position A/B/C)** switch to the position of the required zone.  
If the zone number entered is unprogrammed, the display shows `INVALID`. Repeat this step.

## 5.2

### Selecting a Radio Channel

**When and where to use:** A channel is a group of radio characteristics, such as transmit/receive frequency pairs.

**Procedure:**

Select a channel using the preprogrammed **16-Position Select Knob** to the desired channel.

- a. Rotate the preprogrammed **16-Position Select Knob** to the desired channel.

## 5.3

### Receiving and Responding to a Radio Call

Once you have selected the required channel and/or zone, you can proceed to receive and respond to calls.

The radio shows different indicators based on the system the radio is configured.

- The LED lights up solid red while the radio is transmitting.
- In conventional mode, the LED lights up solid yellow when the radio is receiving a transmission.
- In trunking mode, there is no LED indication when the radio receives a transmission.
- If the radio is receiving a secure transmission, the LED blinks yellow.

#### 5.3.1

### Receiving and Responding to a Talkgroup Call

**When and where to use:** When you receive a talkgroup call (while on the Home screen) the radio displays the following depending on the system your radio is configured to:

- For ASTRO Conventional system, the LED lights up solid yellow. The display shows the talkgroup alias or ID, and the caller alias or ID.

- For Trunking system, the display shows the caller alias or ID.

**Procedure:**

1. Hold the radio vertically 1 to 2 inches (2.5 to 5.0 cm) from your mouth.
2. Wait for the Talk Permit Tone. Then, press the **PTT** button to respond to the call.  
The LED lights up solid red.
3. Release the **PTT** button to listen.

5.3.2

## Receiving and Responding to a Private Call (Trunking Only)

A Private Call is a call from one individual radio to another. Other users in the current talkgroup cannot hear the one-to-one call between the two radios. The calling radio automatically verifies that the receiving radio is active on the system and can display the caller ID.

**When and where to use:**

When you receive a Private Call, you hear two alert tones and the LED blinks green. The display shows **CALL RCV**, alternating with the caller alias (name) or ID (number).

**Procedure:**

1. Press the **Call Response** button within 20 seconds after the call indicators begin.
2. Press and hold the **PTT** button to talk. Release the **PTT** button to listen.
3. Press the **Call Response** button to hang up and return to the Home screen.

**Result:**

5.3.3

## Receiving and Responding to a Telephone Call (Trunking Only)

This feature allows you to receive calls similar to standard phone calls from a landline phone.

**When and where to use:**

When you receive a Telephone Call, you hear a telephone-type ringing and the LED blinks green. The backlight of the screen turns green and the display shows **PHN CALL** and the call received icon blinks.

**Procedure:**

1. Press the **Call Response** button within 20 seconds after the call indicators begin.
2. Press and hold the **PTT** button to talk. Release the **PTT** button to listen.
3. Press the **Call Response** button to hang up and return to the Home screen.

5.4

## Methods to Make a Radio Call

You can select a zone, channel, subscriber ID, or talkgroup by using:

- The preprogrammed **Zone** switch.
- The **16-Position Select Channel Knob**.

- A preprogrammed button.

#### 5.4.1

## Making a Talkgroup Call

### Procedure:

1. Turn the **16-Position Select Channel Knob** to select the channel with the desired talkgroup.
2. Hold the radio vertically 1 to 2 inches (2.5 to 5.0 cm) from your mouth.
3. Press the **PTT** button to make the call.

The radio shows different indicators based on the system the radio is configured.

- For ASTRO Conventional system, the LED lights up solid red. The display shows the talkgroup alias or ID.
  - For Trunking system, the LED lights up solid red.
4. Wait for the Talk Permit Tone.
  5. Speak clearly into the microphone.
  6. Release the **PTT** button to listen.

#### 5.4.2

## Making a Private Call (Trunking Only)

### Procedure:

1. Press the preprogrammed **Private Call** button to dial the preprogrammed ID.  
The display shows the preprogrammed ID.
2. Press the **PTT** button to initiate the Private Call.
3. Hold the radio vertically 1 to 2 inches (2.5 to 5.0 cm) from your mouth.  
When you are connected, the display shows the ID of the target radio.  
If no acknowledgment is received, the display shows **NO ACK**.
4. Press and hold the **PTT** button to talk. Release the **PTT** button to listen.
5. Press the preprogrammed **Private Call** button to return to the home screen.

#### 5.4.3

## Making an Enhanced Private Call (Trunking Only)

**Prerequisites:** Your radio must be preprogrammed to allow you to use this feature.

### Procedure:

1. Press the preprogrammed **Quick Access (One-Touch) Private Call** button to dial the preprogrammed ID and initiate the Enhanced Private Call.  
The display shows the preprogrammed ID and a ringing tone sounds.
2. Hold the radio vertically 1 to 2 inches (2.5 to 5.0 cm) from your mouth.

When you are connected, the display shows the ID of the target radio and the ringing tone stops.

If no acknowledgment is received, the display shows **NO ACK**.

If the target radio does not respond before the time out, the display shows **NO ANSR**.

3. Press and hold the **PTT** button to talk. Release the **PTT** button to listen.
4. Press the preprogrammed **Private Call** button to return to the home screen.

## 5.5

# Switching Between Repeater or Direct Operation Button

The Repeater Operation increases the radio coverage area by connecting with other radios through a repeater. The transmit and receive frequencies are different. The Direct or “talkaround operation” allows you to bypass the repeater and connect directly to another radio. The transmit and receive frequencies are the same.

### Procedure:

Press the preprogrammed **Repeater/Direct** switch to toggle between talkaround and repeater modes.

## 5.6

# Monitor Feature

The monitor feature ensures that a channel is clear before transmitting.

The lack of static on a digital channel when you switch from analog to digital radios is not an indication that the radio is malfunctioning. Digital technology quiets the transmission by removing the noise from the signal and allows only the clear voice or data information to be heard.

### 5.6.1

## Monitoring a Channel

### Procedure:

Monitoring a Channel using the **Monitor** and **Volume Set** button.

- a. Press the preprogrammed **Monitor** button.

The Carrier Squelch indicator appears on the display when you monitor a channel using the preprogrammed Monitor button.

- b. Press and hold the **Volume Set** button to hear the volume set tone.
- c. Adjust the **Volume Control Knob** if necessary.
- d. Release the **Volume Set** button.
- e. Press and hold the **PTT** button to transmit.

The LED lights up solid red.

- f. Release the **PTT** button to receive (listen).

## 5.6.2

# Monitoring Conventional Mode

This feature allows you to monitor channel traffic on conventional channels by defeating the coded squelch. Thus, you can listen to another active user on the channel. This way, you may be prevented from taking over the conversation of another user.

**When and where to use:** Your radio may be preprogrammed to receive Private-Line® (PL) calls.

**Procedure:**

1. Momentarily press the **Monitor** button to listen for activity.  
The Carrier Squelch indicator appears on the display.
2. Press and hold the **Monitor** button to set continuous monitor operation.  
The duration of the button press is programmable.
3. Press the **Monitor** button again, or the **PTT** button, to return to the original squelch setting.  
If you try to transmit on a receive-only channel, you hear an invalid tone until you release the **PTT** button.

## Chapter 6

# Additional Performance Enhancement

The following performance enhancements are some of the latest creations designed to enhance the security, quality, and efficiency of the radios.

### 6.1

## ASTRO 25 Enhanced Data

ASTRO 25 Enhanced Data is optimized to handle different message sizes and variable update rates from different applications of the radio. To improve data channel efficiency and enable denser network traffic, add Enhanced Data to the Integrated Data system with a software installation.

### 6.2

## Dynamic System Resilience

Dynamic System Resilience (DSR) ensures that the radio system is seamlessly switched to a backup master site dynamically during a system failure. DSR also provides indications such as failure detection, fault recovery, and redundancy within the system. DSR also supports mechanisms related to the Integrated Voice and Data (IV&D), or data centric.

### 6.3

## CrossTalk Prevention

CrossTalk Prevention feature prevents crosstalk scenarios and allows the adjustment of the internal SSI clock rate of the radio. This reduces the possibility of radio frequency interfering spurs.

### 6.4

## Encrypted Integrated Data

Encrypted Integrated Data (EID) provides security encryption and authentication of Integrated Voice and Data (IV&D) bearer service. This bridges the communication between the radio and the Customer Enterprise Network.

### 6.5

## SecureNet

SecureNet allows you to perform secured communications on an Analog or Motorola Data Communication (MDC) channel. The MDC Over-the-Air Rekeying (OTAR) feature allows you to perform OTAR activities on an MDC channel.

### 6.6

## Over-the-Air Rekeying

The Over-the-Air Rekeying (OTAR) feature allows the dispatcher to remotely reprogram encryption keys in the radio after a rekey request.

**Single-system OTAR**

This feature allows a radio to be rekeyed by only one Key Management Facility (KMF) or Key Management Controller (KMC).

**Multisystem OTAR**

This feature allows a radio to be rekeyed by multiple KMFs. After an initial programming, the radio is able to seamlessly move to different secure systems associated to a newly selected channel.



**NOTE:** This feature must be programmed by a qualified radio technician. For more information, contact your system administrator.

## 6.7

## P25 Digital Vehicular Repeater System

Motorola Solutions offers an MSI Certified APX compatible, third party, P25 Digital Vehicular Repeater System (DVRS). This provides low-cost portable radio coverage in areas where only mobile radio coverage is available.



**NOTE:** Portable subscriber units enabled in the system for Radio Authentication shall be able to authenticate regardless of whether they are communicating directly on the system or by using a DVRS.

DVRS can also work with SmartConnect to use broadband coverage for the in-vehicle mobile. Portable radios communicate through the in-vehicle mobile to the system through the LTE, Satellite, or Wi-Fi connection. This extends the system coverage when you are away from the vehicle.

## 6.8

## Conventional Talkgroup and Radio Scan Enhancements

Enhancements have been made to the Conventional Talkgroup at the system to improve the Scan feature operation significantly when multiple agencies are using a single conventional radio frequency channel.

These enhancements allow you to use Selective Squelch to operate on only the subset of talkgroups that are relevant to the users rather than all talkgroups on the channel.

The enhancements support the following Scan mode:

- Mixed Vote Scan.
- Standard Conventional Scan.
- Priority Operation.

Up to 30 different talkgroups can be supported using conventional channels. A maximum of four talkgroups can be supported when Vote Scan channels are being used.

Smart PTT is supported with this enhancement as Smart PTT prevents you from transmitting while other users are on the channel.



**NOTE:** User Selectable Talkgroups are not compatible with this Conventional Talkgroup Enhancement.



## Chapter 7

# Advanced Features

This chapter explains the operations of the features available in your radio.

## 7.1

### ViQi

ViQi is a virtual assistant that helps you manage your radio and perform information lookups using voice commands. This feature is purpose-built for public safety and is active when you press the assigned **ViQi** button on the radio, Remote Speaker Microphone (RSM), or compatible mobile microphone.

#### ViQi Virtual Partner



ViQi Virtual Partner helps you to look up information such as license plate, driver's license, and Vehicle ID Number (VIN), and they respond with a result to your query.

**Table 2: ViQi Virtual Partner Queries**

The following table shows the queries supported by the ViQi Virtual Partner feature and their respective commands. Use the following commands followed by the supported query instructions to initiate ViQi Virtual Partner:

- "Look up..."
- "Check..."
- "Run a..."

| Query                         | Examples  |
|-------------------------------|---|
| License plate                 | <p>"Run a <i>&lt;state&gt;</i> license plate <i>&lt;alphanumeric string&gt;</i>"</p> <p>"Check a <i>&lt;state&gt;</i> license plate."</p> <p>"Look up <i>&lt;state&gt;</i> license plate <i>&lt;alphanumeric string&gt;</i>"</p>  |
| Driver's license              | <p>"Run a <i>&lt;state&gt;</i> driver's license <i>&lt;alphanumeric string&gt;</i>"</p> <p>"Check the state of <i>&lt;state&gt;</i> driver's license <i>&lt;alphanumeric string&gt;</i>"</p> <p>"Look up <i>&lt;state&gt;</i> driver's license <i>&lt;alphanumeric string&gt;</i>"</p>  |
| Vehicle Identification Number | <p>"Check Vehicle Identification Number <i>&lt;alphanumeric string&gt;</i>"</p> <p>"VIN check <i>&lt;alphanumeric string&gt;</i>"</p> <p>"Run a VIN."</p> <p> <b>NOTE:</b> You can use variations such as <i>&lt;vehicle identification number&gt;</i>, <i>&lt;VIN&gt;</i>, and <i>&lt;vehicle number&gt;</i>.</p> |
| Own Location                  | <p>"Where am I?"</p> <p>"Can I get my exact location?"</p>  |

| Query           | Examples  |
|-----------------|---|
|                 | <p>“Am I still at the &lt;location&gt;?”</p> <p> <b>NOTE:</b> ViQi will ask for more information to complete the query.</p>                                      |
| Target Location | <p>“Where is &lt;unit name&gt;?”</p> <p>“Tell me where &lt;unit name&gt; is.”</p> <p> <b>NOTE:</b> ViQi will ask for more information to complete the query.</p> |

### 7.1.1

## Using ViQi Virtual Partner

### Prerequisites:

- See [ViQi](#) for the queries supported by this feature.
- To perform the queries, you are required to log in to CommandCentral. See [Logging In to CommandCentral \(Subsequent Login\)](#).

### Procedure:

1. Press and hold the assigned **ViQi** button.
2. After you hear a tone, speak your request into the microphone.
3. Release the assigned programmable button and wait for ViQi to respond.
4. Throughout your session, repeat steps [step 1](#) through [step 3](#) when responding to ViQi. Depending on your query, you can also say the following requests:
  - To play the available results, say “Play results”.
  - To request for more details, say “More details”.
  - To complete the Virtual Partner session, say “Complete”.

### 7.2

## Advanced Call Features

This chapter explains the operations of the call features available in your radio.

## 7.2.1

# Selective Call (ASTRO Conventional Only)

This feature allows you to receive a call from a specific individual with privacy.

### 7.2.1.1

## Receiving a Selective Call

**When and where to use:** When you receive a Selective Call, you hear two alert tones and the LED lights up solid yellow. The backlight of the screen turns green momentarily, the display briefly shows `CALL RCV`, and the speaker unmutes.

**Procedure:**

1. Hold the radio vertically 1 to 2 inches (2.5 to 5.0 cm) from your mouth.
2. Press and hold the **PTT** button to talk. Release the **PTT** button to listen.

### 7.2.1.2

## Making a Selective Call

**Prerequisites:** Your radio must be preprogrammed for you to use this feature.

**Procedure:**

1. Press the preprogrammed **Selective Call** button to dial the preprogrammed ID.
2. Hold the radio vertically 1 to 2 inches (2.5 to 5.0 cm) from your mouth.
3. Press and hold the **PTT** button to start the Selective Call.

The display shows the current zone and channel name.

4. Release the **PTT** button to listen.

The radio returns to home screen. Repeat [step 1](#) to [step 3](#) to start the Selective Call.

## 7.2.2

# Making Priority Dispatch Calls

If a talkgroup is congested, the Priority Dispatch feature allows you to call the dispatcher on a different talkgroup. This talkgroup is called the Priority Talkgroup. Each trunking talkgroup can have its own assigned Priority Talkgroup. Priority Dispatch is not available during Emergency operations. Scan feature is suspended when Priority Dispatch is initiated.

**Prerequisites:** Dispatch console that supports this feature must be preprogrammed to use this feature. Check with your dealer or system administrator for more information on dispatch console supporting this feature.

**Procedure:**

1. Press the preprogrammed **Priority Dispatch** button.

A tone sounds and the radio enters Priority Dispatch mode. The radio exits this mode when the Priority Dispatch Time Out Timer expires.

2. Before the Priority Dispatch Time Out Timer expires, press and hold the **PTT** button to transmit.  
The display shows the Priority Talkgroup alias.
3. Release the **PTT** button to listen.  
The radio exits Priority Dispatch mode, returns to its original talkgroup, and displays the home channel alias.

### 7.2.3

## Dynamic Regrouping (Trunking Only)

This feature allows the dispatcher to temporarily reassign selected radios to a particular channel to communicate with each other.

When your radio is dynamically regrouped, it receives a dynamic regrouping command and automatically switches to the dynamically regrouped channel. You hear a tone and the display shows the name of the dynamically regrouped channel.

When the dispatcher cancels dynamic regrouping, the radio automatically returns to the previous zone and channel.

If you access a zone or channel that has been reserved as a dynamically regrouped mode for other users, you hear an invalid tone.

### 7.2.3.1

## Classification of Regrouped Radios

The dispatcher can classify regrouped radios into Select Enabled or Select Disabled categories.

### Select Enabled

Select-enabled radios are free to change to any available channel, including the dynamic-regrouping channel, once you have selected the dynamic-regrouping position.

### Select Disabled

Select-disabled radios cannot change channels while dynamically regrouped. The radio is forced to remain on the dynamic-regrouping channel.

The Scan and Private Call features are unavailable when your radio is Select Disabled.

### 7.2.3.2

## Requesting a Reprogram (Trunking Only)

This feature allows you to notify the dispatcher when you want a new dynamic regrouping assignment.

### Procedure:

Press the preprogrammed **Reprogram Request** button to send reprogram request to the dispatcher.

The display shows `RPGM` and `PLS WAIT`.

### Result:

If you hear five beeps, the dispatcher has acknowledged the reprogram request. The display shows `ACK RCVD` and the radio returns to the **Home** screen.

If the dispatcher does not acknowledge the reprogram request within six seconds, you hear a low-pitched alert tone and the display shows `NO ACK`.

### 7.2.4

## Multiple Private Line

Multiple Private Line (MPL) is a feature that allows user to modify the PL/DPL codes of the current mode by selecting from a predefined list of codes. For the purpose of accessing different communication sub-groups, repeaters and others, user no longer need to program multiple channels of the same frequency with different PL/DPL codes.

The feature supports the following MPL selection Mode:

**Table 3: MPL Selection Mode**

| Selection Mode | Description  |
|----------------|--|
| Dynamic        | The MPL List selection/functionality is automatically updated (and active on the radio current channel) as users scroll through the available MPL List selections. |
| Static         | While users are scrolling through the radio available MPL List selections, MPL functionality does not change until a new MPL List is manually selected.            |

#### 7.2.4.1

### Selecting Multiple Private Line

**Prerequisites:** Ensure that this feature is enabled in the codeplug and the radio is in Conventional Mode.

**Procedure:**

1. Perform one of the following actions:
  - Press the programmable Multiple Private Line (MPL) Side button.
  - From the **Home** screen, tap  **More**.
2. Tap the required MPL.

The Radio Control Widget displays the selected MPL.

### 7.3

## Remote Monitor

This feature allows the system administrator to turn on the microphone of a targeted radio with a subscriber alias or ID.

When remote monitor feature is activated, the audio transmission can be configured in Customer Programming Software (CPS) to route the audio to the radio internal microphone, wired Remote Speaker Microphone (RSM), or Bluetooth wireless microphone.

In life-threatening or critical situations, the system administrator can remotely monitor any audible activity surrounding the targeted radio.

## 7.4

# Scan Lists

Scan lists are created and assigned to individual channels or groups. Your radio scans for voice activity by cycling through the channel or group. The sequence of scan is as specified in the scan list for the current channel or group.

Your radio supports different types of Scan Lists:

- Conventional Scan List
- Talkgroup Scan List
- Trunking Priority Monitor Scan List

Refer to a qualified radio technician for the maximum number of Scan Lists to be programmed in your radio.

### 7.4.1

## Intelligent Priority Scan

This feature allows you to add or delete conventional channels and trunking talkgroups from multiple systems into the priority scan lists.

When the radio locks onto a channel in the Intelligent Priority Scan list, the radio scans for higher priority member within the same Trunking or Conventional system.

### 7.4.2

## Viewing a Scan List

### Procedure:

Turn the **16-Position Select Knob** to view the members on the list.

### 7.4.3

## Viewing and Changing the Priority Status

### Procedure:

Press the **Top Side (Select)** button to change the priority status of the currently displayed channel or the scan list status icon of the currently displayed channel.

The radio shows one of following priority status icons and scenarios:

- A **Scan** icon indicates that the current channel is in the scan list as a non-priority channel. The LED lights up solid green.
- A **Priority-One Channel Scan** icon indicates that the current channel is in the scan list as the Priority-One channel. The LED rapidly blinks green. You hear all traffic on the Priority-One channel, regardless of traffic on non-priority channels.
- A **Priority-Two Channel Scan** icon indicates that the current channel is in the scan list as the Priority-Two channel. The LED blinks green.
- No icon indicates that the current channel is deleted from the scan list.

## 7.5

# Scan

This feature allows you to monitor traffic on different channels by scanning a programmed list of channels. Scanning is halted if you initiate a call and resumes when the call has ended.

### 7.5.1

## Turning Scan On or Off

### Procedure:

Press the preprogrammed **Scan** button to toggle `SCAN ON` or `SCAN OFF` to initiate or stop scan.

If the scan is enabled, the display shows `SCAN ON` and the scan status icon.

If the scan is disabled, the display shows `SCAN OFF`.

### 7.5.2

## Making a Dynamic Priority Change (Conventional Scan Only)

### When and where to use:

While the radio is scanning, the dynamic priority change feature allows you to temporarily change any channel in a scan list (except for the Priority-One channel) to the Priority-Two channel.

This change remains in effect until scan is turned off. Scan then reverts to the default setting.

### Procedure:

Making a Dynamic Priority Change using the preprogrammed **Dynamic Priority** button:

- a. When the radio locks onto the channel designated as the new Priority-Two channel, press the preprogrammed **Dynamic Priority** button.

The radio continues scanning the remaining channels in the list.

### 7.5.3

## Deleting a Nuisance Channel

### When and where to use:

If a channel continually generates unwanted calls or noise (termed “nuisance” channel), you can temporarily remove the unwanted channel from the scan list.

This capability does not apply to priority channels or the designated transmit channel.



**NOTE:** Deleting a nuisance channel is **only** possible through the preprogrammed **Nuisance Channel Delete** button.

### Procedure:

When the radio is locked onto the channel to be deleted, press the preprogrammed **Nuisance Delete** button.

**Result:** The radio continues scanning the remaining channels in the list.

#### 7.5.4

## Restoring a Nuisance Channel

### Procedure:

To restore the deleted nuisance channel, perform one of the following actions:

- Stop and restart a scan.
- Mode change to another channel and back to the original channel.
- Turn off the radio and then turn it on again.

#### 7.6

## Call Alert Paging

This feature allows your radio to work like a pager.

If other users are away from their radios or if they are unable to hear their radios, you can send them an individual call alert page. You can also verify if a radio is active on the system.

Depending on how your radio is programmed, if there is no answer after the maximum ring time or when you press the **PTT** button for an Enhanced Private Call, the radio automatically sends a call alert page.



**NOTE:** This feature must be programmed by a qualified radio technician.

#### 7.6.1

## Receiving a Call Alert Page

**When and where to use:** When you receive a Call Alert page, you hear four repeating alert tones and the LED blinks green. The call received icons blinks and the display shows `PAGE RCV`.

### Procedure:

Press any button to clear the Call Alert page.

### Result:

#### 7.6.2

## Sending a Call Alert Page

### When and where to use:

Your radio must be preprogrammed for you to use this feature.

### Procedure:

Press the preprogrammed **Call Alert Paging** button to send a page to the preprogrammed ID.

If the call alert page is sent successfully, a tone sounds and the display shows the current zone and channel name.

If the call alert page is not acknowledged, a tone sounds and the display shows the current zone and channel name.



## 7.7

# Recent Calls

Recent call menu allows you to view the recent incoming and outgoing call information.

You can view the information of the following type of calls:

- Call Alert
- Selective Call
- Private Call
- Phone Call (Outgoing Only)
- Emergency Call (Incoming Only)



**NOTE:** The Log Dispatch Calls Enable field need to be enabled in Customer Programming Software (CPS) for your radio to log the dispatch call.

### 7.7.1

## Instant Recall

This feature allows you to save and play back the recent received calls. All saved calls are removed upon radio power cycle.

#### 7.7.1.1

## Saving and Playback Calls

**When and where to use:**

**Procedure:**

- Saving the recorded calls using the preprogrammed **Record Playback** button:
  - a. Long press the preprogrammed **Record Playback** button to save the recorded calls.

Radio displays `Audio Saved` momentarily.

Radio plays the saved call automatically if call saving is successful.

A tone sounds if call saving is not successful.
- Playback the saved calls using the preprogrammed **Record Playback** button:
  - a. Short press the preprogrammed **Record Playback** button to playback the saved calls.
  - b. Short press the preprogrammed **Record Playback** button again to skip to the next saved call. If there is only a single saved call, the playback skips to the end of the call.

Radio auto playback the most recent incoming call followed by saved calls in chronological order.

Radio displays the playback status.



**NOTE:**

Received call overwrites the ongoing record playback. User can short press the programmable button within three seconds to continue the playback and ignore the receiving call.

User can short press the programmable button to trigger playback when the radio is receiving call to overwrite the receiving call.

Playback can be halted by any tone and button press except for specific buttons. Check with your dealer or system administrator for more information.

## 7.8

# In-Call User Alert

This feature allows the radio to remain muted to affiliated talkgroup calls or dispatch calls while operating on the current Trunking Personality or conventional channel respectively.

Group and individual Pages unmute the radio for the alert tone to sound. The radio also unmutes to individual radio-to-radio calls. This feature is very useful when a radio-user prefers not to hear affiliated talkgroup or dispatch calls traffic, but needs-to remain in radio contact. For an In-Call User Alert enabled channel, the Voice Mute button-press or the Voice Mute menu-selection allows the radio-user to toggle on and off Voice Mute functionality.

## 7.9

# Emergency Operation

The Emergency feature is used to indicate a critical situation. An emergency signal overrides any other communication over the selected channel.

Your radio supports the following Emergency modes:

- Emergency Alarm
- Emergency Call
- Emergency Alarm with Emergency Call
- Silent Emergency Alarm<sup>2</sup>

One channel supports only one Emergency mode. The radio responds differently when pressing the programmed **Emergency** button in each channel.

Only one Emergency mode can be assigned to the **Emergency** button.

Your radio is also programmed to operate in one of the following conditions:

### **Tactical/Non-Revert**

The radio sends an emergency alarm and/or makes an emergency call on the current channel.

### **Non-Tactical/Revert for Conventional System**

The radio reverts to the programmed emergency channel to send an alarm and/or make an emergency call.

### **Non-Tactical/Revert for Trunking System**

The radio reverts to the programmed emergency talkgroup (trunking system) or channel (conventional system) to send an alarm and/or make an emergency call.

---

<sup>2</sup> This feature allows you to send an Emergency Alarm to the system without triggering any audio or visual indicators.

Fall Alert is an alternate way to activate the Emergency feature. For more information, see [Fall Alert on page 59](#).

For more information, contact your system administrator.

### 7.9.1

## Special Considerations for Emergency Operation

The following scenarios apply during Emergency operation:

**Table 4: Emergency Operation Scenarios**

| Scenario  | Outcome   |
|---|---|
| If you press the <b>Emergency</b> button while in a channel that has no Emergency capability, | a tone sounds.  |
| If you change to a channel or mode with no Emergency capability while in Emergency operation, | your radio shows the following indications: <ul style="list-style-type: none"> <li>• A tone sounds until you select a valid Emergency channel or mode, or until you disable the Emergency operation.</li> <li>• The display for Model 3.5 and Model 2.5 shows <code>No emergency</code>.</li> <li>• The display for Model 1.5 shows <code>NO EMERG</code>.</li> </ul> |
| If you change to a channel or mode with Emergency capability while in Emergency operation,    | the Emergency Alarm and/or Emergency Call continues on the new channel or mode.   |
| If the radio is out-of-range of the system or the emergency alarm is not acknowledged,        | your radio shows the following indications: <ul style="list-style-type: none"> <li>• A tone sounds.</li> <li>• The display shows <code>No acknowledge</code>.</li> </ul>  |

### 7.9.2

## Emergency Keep-Alive

This feature prevents your radio from turning off when in Emergency mode. If this feature is enabled, you are required to exit Emergency mode before turning off your radio.

### 7.9.3

## Exiting Emergency Operation

If an Emergency operation is triggered on your radio, the dispatch console or radios configured as Supervisor can exit the Emergency operation.

**Procedure:**

Press and hold the programmed **Emergency** button.

### 7.9.4

## Exiting Emergency as Supervisor (Trunking Only)

Radios configured as Supervisor are able to cancel emergency mode of other radios. The dispatch console must be preprogrammed to use this feature. For more information, contact your system administrator.

**Procedure:**

Perform one of the following actions:

| If...   | Then...  |
|---|--|
| If the emergency mode is initiated by other radios,   | press and hold the <b>Side Button 1</b> and press the <b>Emergency</b> button.   |
| If the emergency mode is initiated by the Supervisor, | Perform one of the following actions: <ul style="list-style-type: none"><li>• Press and hold the <b>Emergency</b> button.</li><li>• Press and hold the <b>Side Button 1</b>, and press the <b>Emergency</b> button.</li><li>• Wait for console to clear emergency.</li></ul> |



**NOTE:** The combinations of the following buttons are supported in your radio:

- Radio **Side Button 1** and **Top (Orange)** button.
- Radio **Side Button 1** and accessory **Orange** button.
- Accessory **1-Dot Button** and radio **Top (Orange)** button.
- Accessory **1-Dot Button** and accessory **Orange** button.

### 7.9.5

## Remote Emergency

The Remote Emergency feature allows you to remotely launch the emergency feature on a target radio.

You can send the Remote Emergency request to radios from recently transmitted or received calls that are stored. The latest Recent Call List refreshes automatically on your radio.

### 7.9.5.1

## Receiving Remote Emergency

The remote emergency is launched only if emergency is enabled on your radio. The receiving radio displays **Emergency**.

**Procedure:**

To exit the emergency operation, press and hold the programmed **Emergency** button.

### 7.9.5.2

## Filtering Remote Emergency Contacts

This feature allows you to filter contacts.

**Procedure:**

1. Press the programmed **Remote Emergency** button.
2. Press the **Filtr** menu item button.

**Result:**

Your radio displays the filtered call list.

### 7.9.6

## Sending an Emergency Alarm

**When and where to use:** This feature allows you to send a data transmission, which identifies the radio sending the emergency, to the dispatcher.



**NOTE:** The default timer of **Emergency** button press to activate Emergency is 50 milliseconds. This timer is programmable from 50–6200 milliseconds by a qualified technician.

### Procedure:

Press the preprogrammed **Emergency** button.

One of the following scenarios occurs:

- The display shows `EMERGENCY` and the current zone or channel. You hear a short medium-pitched tone and the LED blinks red momentarily.
- The radio sounds a short low-pitched tone to indicate that the selected channel does not support emergency and rejects to launch emergency mode.

### Result:

When you receive the dispatcher's acknowledgment, the display shows `ACK RCVD`. Four tones sound, the alarm ends, and the radio exits the Emergency Alarm mode.

If no acknowledgment is received, the display shows `NO ACK`. The alarm ends and the radio exits the Emergency Alarm mode.

### 7.9.7

## Sending an Emergency Call (Trunking Only)

**When and where to use:** This feature gives your radio priority access to a talkgroup.

### Procedure:

1. Press the preprogrammed **Emergency** button.

One of the following scenarios occurs:

- The display shows `EMERGENCY` and the current zone or channel. You hear a short medium-pitched tone and the LED blinks red momentarily.
- You hear a short low-pitched tone to indicate that the selected channel does not support emergency and rejects to launch emergency mode.

2. Hold the radio vertically 1 to 2 inches (2.5 to 5.0 cm) from your mouth.
3. Press and hold the **PTT** button. Speak clearly into the microphone.
4. Release the **PTT** button to end the transmission and wait for a response from the dispatcher.
5. To exit Emergency Call, press and hold the preprogrammed **Emergency** button for about a second.

### 7.9.8

## Sending An Emergency Call With Hot Mic (Trunking Only)

This feature allows you to send an Emergency Call with hot mic to a group of radios.

**When and where to use:**

Your radio must be programmed for this type of operation.

Your radio microphone is automatically activated, allowing you to communicate with the group of radios without pressing the **PTT** button. This activated microphone state is also known as hot mic. The hot mic applies to the first voice transmission from your radio during the Emergency call. For subsequent transmissions in the same Emergency call, you must press the **PTT** button.

When indirect PTT such as Hot Mic is activated, the audio transmission can be configured in CPS to route the audio to the radio internal microphone, wired RSM microphone, or Bluetooth wireless microphone.

Follow the procedure to send Emergency Call with hot mic on your radio.

**Procedure:**

1. Press the preprogrammed **Emergency** button.

One of the following scenarios occurs:

- The display shows `EMERGENCY` and the current zone or channel. A tone sounds and the LED blinks red momentarily.
  - A tone sounds to indicate that the selected channel does not support emergency and rejects to launch emergency mode.
2. The microphone remains active for the hot mic time specified in the radio's codeplug programming.
  3. To exit Emergency Call, press and hold the preprogrammed **Emergency** button.

7.9.9

## Sending an Emergency Alarm with Emergency Call

**When and where to use:**

This feature gives your radio priority access on a channel for conventional system, and to a talkgroup for trunking system.

**Procedure:**

1. Press the preprogrammed **Emergency** button.

If successful, the display shows `EMERGENCY` on the current zone and channel. You hear a short, medium-pitched tone and the LED blinks red momentarily.

The radio exits Emergency Alarm and enters the Emergency Call state when one of the following scenarios occur:

- You receive the dispatcher acknowledgment. The display shows `ACK RCVD`.
- You receive no acknowledgment. The display shows `NO ACK`.
- You press the **PTT** button while in the Emergency Alarm mode.

If unsuccessful, you hear the radio sounds a short low-pitched tone to indicate the selected channel does not support emergency and rejects to launch emergency mode.

2. Hold the radio vertically 1 to 2 inches (2.5 to 5.0 cm) from your mouth.
3. Press and hold the **PTT** button. Speak clearly into the microphone.
4. Release the **PTT** button to end the transmission and wait for a response from the dispatcher.
5. To exit Emergency Call, press and hold the preprogrammed **Emergency** button for about a second. Turning off the radio also cancels the emergency state.

### 7.9.10

## Sending An Emergency Alarm and Call with Hot Mic

This feature allows you to send an Emergency Alarm and Call with hot mic to a group of radios.

**When and where to use:** Your radio must be programmed for this type of operation.

When indirect PTT such as Hot Mic is activated, the audio transmission can be configured in CPS to route the audio to the radio internal microphone, wired RSM microphone, or Bluetooth wireless microphone.

Follow the procedure to send Emergency Alarms and Call with hot mic on your radio.

#### Procedure:

1. Press the preprogrammed **Emergency** button.

If successful, the display shows `EMERGENCY` on the current zone and channel. A tone sounds and the LED blinks red momentarily.

The radio exits Emergency Alarm and enters the Emergency Call state when one of the following scenarios occur:

- You receive the dispatcher acknowledgment. The display shows `ACK RCVD`.
- You receive no acknowledgment. The display shows `NO ACK`.

If unsuccessful, a tone sounds to indicate that the selected channel does not support emergency and rejects to launch emergency mode.

2. The microphone remains active for the hot mic time specified in your radio's codeplug programming.
3. To exit Emergency Call, press and hold the preprogrammed **Emergency** button.  
Turning off the radio also cancels the emergency state.

### 7.9.11

## Sending a Silent Emergency Alarm

**When and where to use:** This feature allows you to send an Emergency Alarm to the system without triggering any audio or visual indicators.

#### Procedure:

1. Press the preprogrammed **Emergency** button.

The display shows no changes, the LED does not light up, and you hear no tones. The silent emergency state continues until you perform the next step.

2. Perform one of the following actions:
  - Press and hold the preprogrammed **Emergency** button for about a second to exit the Silent Emergency Alarm mode.
  - Press and release the **PTT** button to exit the Silent Emergency Alarm mode and enter regular dispatch or Emergency Call mode.

### 7.9.12

## Emergency Find Me

When the radio is in Emergency mode, the Emergency Find Me feature transmits Bluetooth Low Energy (BTLE) signals, and other emergency information to nearby radios.

For more information, contact your system administrator.

### 7.9.12.1

## Receiving Emergency Beacons

### When and where to use:

The receiving radio displays `Beacon Received`, the transmitting radio Contact ID, or alias. The following methods are options on how to receive the beacon.

### Procedure:

Perform one of the following:

- Tap `Details` to view the beacon list.
- Tap `Dismiss` to dismiss the beacon.



**NOTE:** If there are multiple beacons, the radio displays the recent beacon received.

## 7.10

# Fireground

The portable Fireground Communications System is designed for deployment at an incident scene.

It consists of central components that provide on-scene and in building radio coverage, and enhanced personnel accountability and monitoring:

- Your APX portable radios
- Incident Management Software
- Command Terminal
- Radio Frequency (RF) Modem (Conventional Only)
- Control Channel Radio (Trunking)
- Optional Data Radio (Trunking)
- Accountability Server (Trunking)
- DVRS (Optional)

If you have a critical situation, you can press the Emergency button, which activates an alarm on the Incident Management Software at the command terminal.

The command terminal receives the following status updates from your radio:

- Turning the radio on and off
- Automatic response to Polling
- Response to Evacuation commands
- Pressing the **PTT** button to make voice transmission
- Sending an Emergency Alarm and Call
- Entering or Exiting a Trunking Talkgroup



### 7.10.1

## Entering Fireground Zone Channel (Conventional)

### Procedure:

1. Upon powering up, one of the following scenarios occurs:
  - If the Fireground Zone Channel is set as default, you hear the gurgle tone and the radio displays the home screen. You are in Fireground zone channel.
  - If the Fireground Zone Channel is set as default, but you hear a short, low-pitched tone, the display shows `REG FAIL` to indicate that the command terminal does not respond to Fireground Zone Channel. Get a qualified technician for assistance.
  - If your home channel is not Fireground Zone Channel, toggle or change the radio zone channel to Fireground Zone Channel.

If you are entering Fireground Trunking Talkgroup, upon powering up, ensure that the Fireground Trunking Talkgroup is selected. The subscriber unit automatically appears on the Incident Commander's terminal.

2. Listen for a transmission. Adjust the **Volume Control Knob** if necessary.
3. Perform one of the following actions:
  - Press and hold the preprogrammed **Volume Set** button to hear the volume set tone. Adjust the **Volume Control Knob** if necessary. Release the **Volume Set** button.
  - At the desired Fireground zone and channel, press the preprogrammed **Monitor** button and listen for activity. Adjust the **Volume Control Knob** if necessary.
  - If your radio is working in Fireground Zone Channel, proceed to next step.
4. Press and hold the **PTT** button to transmit. The LED lights up solid red while transmitting. Talk into the microphone clearly if needed.
5. Release the **PTT** button to receive.  
You hear a Transmit End Tone.

### 7.10.2

## Responding to Evacuation Indicator

**When and where to use:** The Incident Commander can trigger one of sixteen Tactical Alerts from the Command Terminal. These alerts can target individuals or groups of users within the Fireground Communication System. The ergonomic (visual and audible) response for the Tactical Alerts can be customized.

Your radio sounds the audible response at the profile maximum alert tone volume level. The display shows the configurable programmed alert text and intelligent lighting.

### Procedure:

Perform one of the following actions:

- Press the radio **Top Side** button.
- Press the RSM **Side Button 1** if the radio is connected to RSM.
- Press the **PTT** button. **PTT** button must be configured in Customer Programming Software (CPS) to enable this function.

The radio cancels the indications, a tone sounds and the radio sends an acknowledgment to the command terminal.



**NOTE:** Move the **Volume Control Knob** to adjust the volume of the audible alert from full volume.

## 7.11

# Sending Evacuation Tone

This feature enables the evacuation tone to be heard on the transmitting radio and on any radio that is able to receive the tone instruction.

### Procedure:

**Result:** Once the tone begins to sound, if the orange button is released the tone continues to alarm on all radios within the talkgroup, until the **PTT** button is released.



**NOTE:** Radio does not transmit evacuation tone if the radio is in secure mode.

## 7.12

# Tactical Public Safety (Conventional Only)

Tactical Public Safety (TPS) enables the member of a group to identify the start and the end of a transmission by displaying the caller name or ID on the radio display.

### 7.12.1

## Using TPS Normal Transmission

### Procedure:

At TPS Zone Channel, perform one of the following actions:

- Press **PTT** button to transmit. Talk clearly into the microphone. Release **PTT** button to listen.
- Receive and listen to call, the radio displays the caller's name or ID.

### 7.12.2

## Using TPS Emergency Transmission

The following are two important alert tones designed for this feature.

### Emergency Beacon

If you press the **Emergency** button during an emergency, the radio sounds a Beacon at maximum volume using the radio internal speaker (not adjustable). When pressing the **PTT** button for voice communication, the beacon is muted.

### Emergency Call De-Key Sidetone

The radio sounds an alert tone to remind you that the Emergency Mode is still active after you release the **PTT** button for an Emergency call transmission. The volume of loudness depends on the maximum tone volume set in your radio profile.

### Procedure:

1. Press the **Emergency** button to enter Emergency Mode.

The Emergency Beacon tone sounds.

2. Press **PTT** button to make an Emergency Call.
3. Release to listen.  
The Emergency Call De-Key Sidetone sounds. After a short pause, the Emergency Beacon tone sounds.
4. Press and hold the **Emergency** button to exit Emergency mode and cancel Emergency Beacon.

### 7.13

## Fall Alert

Fall Alert is a supporting feature of the Emergency operation. The Emergency feature must be programmed for Fall Alert to operate.

Your radio activates the Fall Alert feature when it achieves or exceeds a tilt angle threshold or a combination of the angle threshold and radio motion below the motion sensitivity level. The radio must stay in this condition for a programmed period before the Emergency Alarm or Call is activated.



**NOTE:** Because Fall Alert may be triggered accidentally, consider the following scenarios when using your radio:

- If the radio is programmed to a horizontal position only, it must be worn in a vertical position.
- If the radio is programmed with the Fall Alert feature, turn off the radio when charging it with a wall-mounted charger.
- When you dismiss Fall Alert and keep the radio horizontal, no emergency will be sent and no further Fall Alert notification will occur until the device is rotated back to normal (portrait) mode.

### 7.13.1

## Radio Alerts When Fall Alert is Triggered

When Fall Alert is triggered, your radio plays an alert tone, and the display shows `Fall Alert`.



**NOTE:** If the radio is programmed for Surveillance Mode, the radio inhibits all tones and lights including the Fall Alert tones.

### Fall Alert Enhanced

Your radio also supports Fall Alert Enhanced where an alert tone is played for a programmed period. This tone is louder than the programmed minimum level or the current level of the speaker. This tone acts as a beacon to help find the radio.



**NOTE:** The radio plays this alert tone even in Surveillance Mode.

When the alert tone is active, changing to another channel with a different setup triggers a different response from the radio:

- The alert tone is inhibited when you change to a channel without Emergency feature.
- The alert tone is inhibited when you change to a channel with Emergency but no Fall Alert feature.
- The current alert tone is inhibited and is replaced with a different alert tone when you change to a channel with Emergency feature and a different Fall Alert configuration.
- The alert tone continues when you change to a channel with Emergency and similar Fall Alert configuration.

### 7.13.2

## Testing Fall Alert

**Prerequisites:** Ensure that Fall Alert feature is configured in your radio.

**Procedure:**

1. Turn on the radio, and place it in a vertical position for at least 5 seconds.
2. Lay the radio down in a horizontal position.

**Result:**

The radio plays an alert tone and the display shows `Fall Alert`.

**Postrequisites:** If Fall Alert is configured but the condition does not trigger the activation of the feature, send the radio to a qualified technician.

### 7.13.3

## Exiting Fall Alert

**Procedure:**

To exit Fall Alert mode, press **Clr**.

### 7.13.4

## Reinitiating Fall Alert

**Procedure:**

To reinitiate Fall Alert after exiting Emergency Operation, perform one of the following actions:

- Return the radio to a vertical position.
- If motion sensitivity is enabled, shake the radio.

## 7.14

# Secure Operations

Secure radio operation provides the highest commercially available level of voice security on both trunked and conventional channels.

By default, the radio automatically enters the encrypted environment without having to manually select or clear the secure transmission.

### 7.14.1

## Selecting Secure Transmissions

**Procedure:**

Turn the preprogrammed **Secure/Clear** switch to the secure position.

- If the selected channel is preprogrammed for clear-only operation, when you press the **PTT** button, you hear an invalid mode tone and the display shows `CLR TX`.
- The radio does not transmit until you set the **Secure/Clear** switch to the clear position.

- If the “Ignore **Secure/Clear** Switch when Strapped” programming option is enabled, the radio transmits without displaying any messages in the strapped mode of operation, regardless of the **Secure/Clear** switch setting. This option must be preprogrammed by a qualified radio technician.
- The **Secure/Clear** switch only applies when the radio is transmitting.

#### 7.14.2

## Selecting Clear Transmissions

### Procedure:

Turn the preprogrammed **Secure/Clear** switch to the clear position.

- If the selected channel is preprogrammed for secure-only operation, when you press the **PTT** button, you hear an invalid mode tone and the display shows `SEC TX`.
- The radio does not transmit until you set the **Secure/ Clear** switch to the secure position.
- You can request to configure the radio to ignore the clear voice or insecured transmission when the radio is in secured transmission. Check with your agent for details.
- If the “Ignore **Secure/Clear** Switch when Strapped” programming option is enabled, the radio transmits without displaying any messages in the strapped mode of operation, regardless of the **Secure/Clear** switch setting. This option must be preprogrammed by a qualified radio technician.
- The **Secure/Clear** switch only applies when the radio is transmitting.

#### 7.14.3

## Managing Encryption

This chapter explains the encryption feature on your radio.

#### 7.14.3.1

## Loading Encryption Keys

### Prerequisites:

- Refer to the *Key Variable Loader (KVL) manual* for equipment connections and setup.

### Procedure:

1. Attach the KVL to your radio.

The display shows `KEYLOAD` and all other radio functions, except for power down, backlight, and volume, are locked out.



#### **NOTE:**

If the Multi-system Over-the-Air Rekeying feature is in use, the ASTRO profile name is displayed below `KEYLOAD`.

2. Select the required keys and press **Load** on the KVL.

**Result:** The KVL indicates that keyload is successful.

### 7.14.3.2

## Multikey Feature

This feature allows your radio to be equipped with different encryption keys and supports the DES-OFB algorithm.

There are two types of encryption keys:

### Conventional Multikey

The encryption keys are strapped on a one-per-channel basis, through Customer Programming Software (CPS). In addition, you can have operator-selectable keys, operator-selectable keysets, and operator-selectable key erasure. If talkgroups are enabled in conventional, then the encryption keys are strapped to the talkgroups.

### Trunked Multikey

If both conventional and trunked applications are applied, strap the encryption keys for trunking on a per-talkgroup, or announcement-group basis. Also, a different key can be strapped to other features such as dynamic regrouping, failsoft, or emergency talkgroup. You can have operator-selectable key erasure.

### 7.14.3.3

## Erasing Encryption Keys

If the Multi-system Over-the-Air Rekeying feature is in use, the keys erased are only for the current secure profile of the selected channel. The erase all option operates as configured by the dealer or system administrator. Erasing all keys using the Top (Orange) button and the Top Side (Select) button erases all keys in all keylists in the radio.

### Procedure:

Erasing the single key in radios with the single-key option and erasing all keys in radios with the multikey option by using the preprogrammed **Top Side (Select)** button and **Top (Orange)** button:

- a. Press and hold the **Top Side (Select)** button.
- b. While holding **Top Side (Select)** button down, press the **Top (Orange)** button.

The display shows `PLS WAIT`. When all the encryption keys have been erased, the display shows `ALL ERASED`.



**NOTE:** Do **not** press the **Top (Orange)** button before pressing the **Top Side (Select)** button, unless you are in an emergency situation as this sends an emergency alarm.

### 7.14.3.4

## Requesting an Over-the-Air Rekey

If the Multi-system Over-the-Air Rekeying feature is in use, the rekey request is only for the current selected secure profile.

**Prerequisites:** Ensure that the Unique Key Encryption Key (UKEK) or Unique Shadow Key (USK) is loaded into the radio with the Key Variable Loader (KVL) before the rekey request can be sent. Refer to your local key management supervisor for more information.

### Procedure:

Press and hold the preprogrammed **Rekey Request** button to send the rekey request.

If the rekey operation fails, a bad-key tone sounds and the display shows `RKY FAIL`.



**NOTE:** The rekey operation failure indicates that your radio does not contain the UKEK or USK.

### 7.14.3.5

## MDC OTAR (Conventional Only)

This feature allows you to view or define the Motorola Data Communications (MDC) Over-the-Air Rekeying (OTAR) features. This feature is applied only when operating in secure encrypted mode. In addition to Rekey Requests, OTAR transmissions include Delayed Acknowledgments, and Power-up Acknowledgments.

Some of the selected options require configuration at the Key Management Controller (KMC) site to work properly.



**NOTE:** This feature must be programmed by a qualified radio technician. For more information, contact your system administrator.

### 7.14.3.6

## Infinite UKEK Retention

This feature enables Unique Key Encryption Key (UKEK) to be permanently stored in the radio even when all the encryption keys are erased. Without this UKEK key, the radio cannot be rekeyed over the air. The Infinite UKEK Retention settings can be different for each secure profile.



**NOTE:** This feature must be programmed by a qualified radio technician. For more information, contact your system administrator.

### 7.14.3.7

## Hear Clear

Hear-Clear is a noise reduction system that consists of Comping and Random FM Noise Canceller.

### Comping

Reduces the channel noise, such as OTA transmission that is predominantly present in UHF2 and 900 MHz channel with the following features:

#### Compressor

Reduces the background noise flow and the speech signal at transmitting radio.

#### Expander

Expands the speech while the noise flow remains the same at receiving radio.

### Random FM Noise Canceller (Flutter Fighter)

Reduces the unwanted effects of random FM noise pulses caused by channel fading under high Signal-to-Noise (S/N) conditions such as in a moving transportation. The fading effects, heard as audio pops and clicks, are canceled without affecting the desired audio signal.

The Random FM Noise Canceller operates only in receive mode.



**NOTE:** This feature must be programmed by a qualified radio technician. For more information, contact your system administrator.

## 7.15

## Radio Inhibit

This feature allows the system administrator to put a radio into a nonfunctional state when the radio is missing or in an unknown hand. The radio stays in this state regardless of its power changes.



### NOTE:

If the radio has Intersystem roaming capability, the system administrator is able to put the radio into a nonfunctional state when the missing radio roams to another system.

The radio can only be uninhibited by receiving an uninhibited command from the system administrator.

## 7.16

# Location

The Global Navigation Satellite System (GNSS) in the radio integrates information from the Global Positioning System (GPS) and the Global Navigation Satellite System (GLONASS) to determine the approximate geographical location of your radio.



**NOTE:** The Location feature is addressed as Global Positioning System (GPS) across the manual as the naming convention of the buttons and strings remain the same as the legacy feature of GPS.

The availability and accuracy of this location information and the calculation duration can vary depending on the environment in which you are using the GPS feature. For example, GPS location fixes are difficult to obtain indoors, in covered locations, between high buildings, or in situations where you have not established a clear broad view of the sky.

If adequate signals from multiple satellites are available, your GPS feature only provides an approximate location, usually within 10 meters from your actual location, but sometimes farther away.

Sometimes, the GPS feature cannot complete a location calculation successfully. You will then see a message indicating that your radio cannot connect to enough visible satellites.

To maximize the ability of your radio to determine a fix, take note of the following guidelines:

- For your initial fix, hold the radio in the face position.
- Stay in the open as the GPS feature works best when there is nothing between your radio and the open sky.

### 7.16.1

## Location Format

This feature allows you to select different display formats of GPS location.

The following GPS location formats are available:

- Lat/Long (DD)
- Lat/Long (DDM)
- Lat/Long (DMS)
- UTM/UCS
- SLD99
- MGRS



**NOTE:** When you send your location to another radio, the receiving radio displays the location in its selected format.

### 7.16.2

## Location Feature in Emergency Mode

When the Emergency feature is activated, the radio exits the Location menu and returns to the Home screen.

You can view the channel that triggers the emergency signal.

You can reenter the Location menu while still in Emergency mode as long as Silent Emergency is not activated.

If you have disabled the Location feature on your radio, it automatically turns back on when Emergency mode is activated.



If there is a solid location signal during Emergency operation, the current location and the location information received is saved as Emergency and Last Known Location respectively.

## 7.17

# Mission Critical Geofence (ASTRO 25 Trunking)

This feature allows your radio to use the Global Positioning System (GPS) receiver to determine its location at frequent intervals, and evaluate if the radio is within the Geofence area in real time. Geofence is a virtual perimeter based on the GPS to define a geographical area on earth.

When your radio enters the predefined Geofence area, your radio receives the Dynamic Regroup command from the system, and immediately connects to a Dynamic Regroup talkgroup. The radio display shows the new selected Dynamic Regrouped talkgroup with green intelligent light for your attention. Voice Announcement is also available to support this feature.

Any new text messages received at Geofence are displayed immediately on the radio display.



**NOTE:**

If the radio is set up in DVRS, only mobile radio is supported for this feature.

The user navigation for this feature is only available for Model 3.5 and Model 2.5.

## 7.17.1

# Entering the Geofence Area

**Prerequisites:** The Voice Announcement in this feature is optional. They must be configured to enable you to hear and see these indicators.

**When and where to use:** When the radio enters a Geofence area, the radio immediately sends a message ACK back to the system.

The radio searches the current zone for the channel with same talkgroup assigned as the Dynamic Talkgroup and also with same system ID of current trunk system. Once matched, the radio display shows the first matched and connected channel alias.

If there is no channel with matching Talkgroup ID and trunk system ID, the radio display shows the channel alias of `<DYNAMIC talkgroup>`.

Once the radio is connected, you hear a dynamic regroup tone, the radio display shows `<DYNAMIC channel>` with the temporary green color intelligent backlight and you hear a Voice Announcement.



**NOTE:**

When the radio loses the GPS signal, the GPS icon blinks and the radio sounds two high-pitched tones repetitively to indicate that the GPS has failed to operate. The radio display shows the red intelligent light.

If the first matched channel is not configured with Voice Announcement, no Voice Announcement is played.

The system sends a message to your radio. The radio display shows a direct text message content without any user operation. This message indicates that you are currently present in a Geofence area. This TMS remains open on the display until user presses exit/home to exit this screen.



**NOTE:** If there is another incoming text message before you exit the previous message, the message screen is refreshed to show the latest message.

The following procedure guides you to exit the text message received.

**Procedure:**

Press the **Menu Select** button below `Exit` or to return to **Home** screen.

**Result:**

The other operations are the same as normal dynamic regroup command.

When the radio exits the Geofence area, your radio reverts to original channel or newly assigned talkgroup. The radio display shows the new channel together with Voice Announcement to indicate the changes. Voice Announcement of the new channel only works if that channel is configured with Voice Announcement.

### 7.17.2

## Mission Critical Geofence

This feature allows the radio to use the GPS receiver to determine radio location at frequent intervals and evaluate if the radio is within the Geofence area in real time.

Check with your dealer or qualified technician to program the geofence coordinates and actions.

### 7.17.3

## Entering Mission Critical Geofence

**When and where to use:**

When the radio enters the predefined Geofence area, the radio displays `<Geofence Alias>` with the intelligent backlight and you hear a Voice Announcement. Zone and channel alias of the Geofence area is displayed. If the radio is set to manual, you can choose either to proceed with zone and channel change or cancel the change.

The radio then connects to the designated talkgroup. The radio displays the talkgroup alias and dynamic regroup tone sounds. The transmit power level changes and the radio shows a direct text message content without any user operation.



**NOTE:**

The availability of the Voice Announcement (VA), TMS display, Intelligent Backlight, and Transmit Power Level alerts depend on your radio configuration. The VA can be programmed to alert continuously or momentarily.

If Site Selectable Alert (SSA) is enabled, the radio mutes any alert that is received when entering the Geofence area and unmutes when exiting.

### 7.17.4

## Exiting Mission Critical Geofence

**When and where to use:**

When the radio exits the Geofence area, the radio reverts to the original transmit power level, intelligent lighting, channel, or newly assigned talkgroup. Voice announcement is canceled or you hear a

preprogrammed VA tone. The radio displays the new channel and a message is received to indicate the changes.

## 7.18

# Trunking System Controls

This chapter explains the trunking system control features in your radio.

## 7.18.1

### Operating in Failsoft System

#### **When and where to use:**

The failsoft system ensures continuous radio communication during a trunked system failure. If a trunking system fails completely, the radio goes into failsoft operation and automatically switches to its failsoft channel.

During failsoft operation, your radio transmits and receives in conventional operation on a predetermined frequency. You hear a medium-pitched tone and the display shows `FAILSOFT`.

When the trunking system returns to normal operation, your radio automatically leaves failsoft operation and returns to trunked operation.

To continue in Failsoft and to communicate with other talkgroups, refer to the following procedure.

#### **Procedure:**

1. Rotate the **16-Position Select Knob** to change to a different repeater frequency.
2. Press the **PTT** button to talk, and release the button to listen.

## 7.18.2

### Imbalanced Coverage

Imbalanced coverage occurs when the radio is able to receive the control channel but is unable to transmit back to the system. The radio generates a periodic tone and displays `No Comms`.

## 7.18.3

### Out-of-Range Radio

Your radio can no longer lock onto a control channel when out-of-range from the system.

When out-of-range, your radio shows the following indications:

- A tone sounds.
- The display shows the currently selected zone or channel combination, and out-of-range notification.

Your radio remains in this out-of-range condition until it locks onto a control channel or failsoft channel, or if it is turned off.

## 7.18.4

### SmartConnect

SmartConnect allows your radio to maintain voice communication when LMR is out of range by switching to a Wi-Fi, LTE through Tethered Data Modem and Satellite through Ethernet.

Before switching broadband connections, your radio compares the relative signal strength of the various broadband connection types to one another, as well as LMR. Your radio remains or returns to LMR when all the other broadband connections fall below the quality thresholds. SmartConnect selects Wi-Fi over

LTE when both broadband connections are considered the same quality according to the SmartConnect quality threshold. Otherwise, the highest quality broadband adapter is selected. In addition, a radio operating on a lower priority broadband connection returns to the higher priority or quality connection while idle on SmartConnect.

Your radio can connect through a fixed Wi-Fi access point in buildings or in-vehicle Broadband modem such as the following modems:

- Motorola Solutions VML750
- Sierra Wireless MP70
- Sierra Wireless GX450

Your radio displays the SmartConnect capable icon  on the SmartConnect enabled channel. While switching from LMR to SmartConnect, your radio displays Searching Site. When the device is connected to

an available network, your radio displays the SmartConnect Connection icon. 

Your radio displays *Out of Range* when both LMR and SmartConnect are unavailable.



**NOTE:**

The SmartConnect feature must be programmed by a qualified radio technician. For more information, contact your system administrator.

The Searching Site display is only visible on the radio when you enable this feature through the Customer Programming Software (CPS).

### 7.18.5

## Site Trunking Feature

If the Zone Controller loses communication with any site, that site reverts to site trunking. When this occurs, you can communicate only with the radios within your trunking site.

The display shows the currently selected zone or channel, and the site trunking message.

### 7.18.6

## Site Search

When searching for a site, your radio is inoperable. In the site search mode, your radio scans for trunked control channels but has yet to connect to the trunking system or reach other trunking states. Other trunking states are such as *Out of Range* and *Imbalanced Coverage*.

The *Searching site* indicator alerts you that your radio is attempting to search for a valid trunked control channel.

### 7.18.7

## Locking and Unlocking a Site

**When and where to use:** This feature allows your radio to lock onto a specific site and not roam among wide-area talkgroup sites. This feature should be used with caution, since it inhibits roaming to another site in a wide-area system.

**Procedure:**

Use the preprogrammed **Site Lock/Unlock** button to toggle the lock state between locked and unlocked.

**Result:** The radio saves the new site lock state and returns to the Home screen.

### 7.18.8

## Viewing the Current Site

### Procedure:

Press the programmed **Site Displ/Srch** button.

**Result:** The display shows momentarily the name of the current site and its corresponding received RSSI.

### 7.18.9

## Changing the Current Site

### Procedure:

Press and hold down the preprogrammed **Site Displ/Srch** button.

You hear a tone and the display shows momentary `SCANNING`.

**Result:** When the radio finds a new site, it returns to the Home screen.

### 7.19

## Mission Critical Wireless Bluetooth® Wireless Technology

This feature allows you to extend your radio functionality by connecting to external Bluetooth accessories. Use Motorola Solutions proprietary Operations Critical Wireless (OCW) devices with radios during critical operations. Other Bluetooth devices may or may not perform to the required standard.

Your radio supports the following Bluetooth enabled devices or profiles:

- Headset (HSP)
- Dial Up Networking (DUN)
- Personal Area Networking (PAN)
- Serial Port (SPP)
- Generic Access Profile (GAP)
- General Attribute Profile (GATT)

### 7.19.1

## Pairing with Low Frequency-Motorola Proximity Pairing (LF-MPP) Feature

### Prerequisites:

Ensure that Bluetooth feature of your radio is on and the Bluetooth tones are enabled.

Bluetooth tones, Bluetooth menu and preprogrammed buttons must be preprogrammed by a qualified radio technician. Check with your dealer or system administrator for more information.

**When and where to use:** The range of Bluetooth operation when using a MCW accessory is 10 meters line-of-sight communication. This is an unobstructed path between the location of the signal transmitter (your radio) and the location of the receiver (your device or accessory).

Obstacles that can cause an obstruction in the line-of-sight include trees, buildings, mountains, cars, and others.

For high degree of reliability, Motorola Solutions recommends to **NOT** separate the radio and the accessory. At the fringe areas of reception, both voice and tone quality will start to sound "garbled" or "broken". To correct this problem, simply position the accessory and radio closer to each other (within the 10 meter defined range) to re-establish clear audio reception.

 **NOTE:** Once a COTS headset is paired to your radio, it is always connected. Therefore the battery life of the accessory is aligned with the Talk Time power consumption, not the Standby Time consumption.

**Procedure:**

1. Turn on the accessory.
2. Place the accessory close to the radio aligning the Bluetooth Pairing Location (a blue dot) on the radio to the Bluetooth Pairing Location (a blue dot) on the accessory.

If the pairing process is successful, you hear an incremental-pitched tone. The radio begins to connect to the device.

If the pairing process fails, you hear a short, low-pitched tone. The display shows `PAIRFAIL`. Repeat this step.

**Result:**

The radio tries to establish connection with the device once paired.

 **NOTE:** If the connection fails within 6 seconds, you hear a decremental-pitched tone to indicate that the device is unpaired. The display shows `<Device Type> UNPAIRED`. Repeat this step to re-initiate the pairing process.

If the connection is successful, you hear an incremental-pitched tone. The display shows `<Device Type> CONNECTED` and the Bluetooth icon turns from  to .

If the radio has the pairing record of the device and the connection fails, you hear a short, low-pitched tone. The display shows `<Device Type> CON FAIL`.

## 7.19.2

# Responder Alert Sensors

Responder alert sensors allow the radio to send an over-the-air (OTA) notification when the radio receives the holster, weapon fired, and vest pierced sensor events.

To enable the feature, ensure that the Global Positioning System (GPS), Enhanced Data, and Bluetooth feature of your radio is turned on and the radio supports Bluetooth Low Energy (BTLE).

You can disable the feature temporarily or permanently. This feature allows you to prevent one or all events from being reported OTA.

This feature is enabled through Customer Programming Software (CPS) configuration. For more information, contact your system administrator.

 **NOTE:** The radio reports the next event after the programmed 15-second timer expires. Any consecutive event occurring within the timer is not reported to avoid multiple reports over the same incident.

### 7.19.2.1

## Holster Sensor

Holster sensor monitors the state of the holster and allows the radio to send an Over-The-Air (OTA) notification whenever a gun or a taser is pulled out of the holster or put in the holster.

The sensor can cache events that happen when the sensor is disconnected from the radio. When the sensor is reconnected, the radio evaluates and sends the important events OTA to the system. For more information, contact your system administrator.

If the sensor is disconnected from the radio for more than 30 minutes or if disabled, the holster sensor clears the cached events.

#### 7.19.2.2

### Weapon Fired Sensor

This feature allows the radio to send an Over-The-Air (OTA) notification when a weapon enabled with the sensor is fired. The event is immediately sent to the system to alert the dispatcher of the weapon fired incident.

#### 7.19.2.3

### Vest Pierced Sensor

Vest Pierced sensor is located inside a bulletproof vest. The sensor reports an event to the radio when the vest is pierced due to various causes such as bullet shot or knife stabbing.

This feature allows the radio to send an emergency message and Over-The-Air (OTA) notification when a vest piercing event occurs. The event is immediately sent to the system to alert the dispatcher of the vest pierced incident.

The receiving radio displays `VPierced RCVD` to indicate that the sender is in a Vest Pierced Emergency event.

#### 7.19.2.4

### Disabling the Sensor

This feature disables the sensors temporarily or permanently from sending the sensor events to the system.



**NOTE:** The feature is only applicable to holster sensor and weapon fired sensor. Vest pierced sensor cannot be disabled.

#### 7.19.2.4.1

### Disabling the Sensor Temporarily

#### Procedure:

Short-press the preprogrammed **Sensor** button to activate the sensor timer.

The following scenarios affect the sensor state:

- If a gun or taser is removed from the holster within the timer duration, the timer stops and switches the sensor to disabled state. A tone sounds and the radio displays `Sensor Disable`.



**NOTE:** The radio enables the sensor only when all the guns or tasers are placed into the holster. A tone sounds and the radio displays `Sensor On temporarily`.

- If the timer expires without an event, a tone sounds, the radio switches the sensor to enabled state, and clears the sensor status from the display.
- If the preprogrammed **Sensor** button is long-pressed, the OTA sensor notification is enabled.

#### 7.19.2.4.2

### Disabling the Sensor Permanently

#### Procedure:

1. Long-press the preprogrammed **Sensor** button to permanently disable the sensors.

A tone sounds and the radio displays `Sensor Off`. While in this state, no events is reported over-the-air (OTA), regardless of how many times the gun is drawn, re-inserted or weapon is fired.

The radio generates a bad key tone if the sensor is not allowed to be disabled or there is no sensor connected to the radio when the preprogrammed button or menu select button is pressed.

2. Long-press the preprogrammed **Sensor** button again to enable the OTA Sensor notification.

A tone sounds, and the radio displays `SNSR OFF`.

#### 7.20

### ASTRO 25 (P25) Programming Over Project 25 (POP25)

Also called Over-the-Air Programming, this feature allows configuration data and firmware to be upgraded to your radio over-the-air. Full use of the radio is retained during the data transfer without interrupting communication.

If the upgrade happens on the ASTRO 25 and ASTRO Conventional systems, the upgrade pauses to give priorities to voice call, and continues after the voice call ended. If the upgrade happens on a Wi-Fi network, the upgrade process runs concurrently with voice calls.

Once a configuration upgrade is downloaded to your radio, you can install new changes immediately, or delay changes to be installed on the radio when it is being powered up.

Your radio can also be configured to allow you to accept or reject an upgrade.



**NOTE:** The Remote Speaker Microphone (RSM) firmware updates are carried out by the radio. Your radio will not show any notification as the updates are happening in the background.

#### 7.21

### Voice Announcement

This feature enables the radio to audibly indicate the current feature mode, zone, or channel assigned to the user.

The available voice announcement (VA) priority options are:

#### High

Voice announcement is enabled even when the radio is receiving calls.

#### Low

Voice announcement is disabled when the radio is receiving calls.



**NOTE:** If the **Voice Announcement** field is set to **Enabled**, after an interruption by a momentary tone one of the following scenarios occurs:

- If **Suppress Replay** field is **Enabled**, voice announcement replays.
- If **Suppress Replay** field is **Disabled**, voice announcement turns off.



## 7.22

# Site Selectable Alerts (ASTRO 25 Trunking)

A Site Selectable Alert (SSA) is an Intelligent Lighting indicator with audio alert. The alert is sent to radios at sites to notify the users when special situations occur.

Your radio supports up to 250 site aliases. Only authorized radios are enabled to send SSA.



### NOTE:

The alert alias, alert tone, and alert period are configured in the Customer Programming Software (CPS). For more information, contact your system administrator.

The SSA alert volume is reduced when voice audio is received at the same time. It is important that the SSA audio file is created with clear loud audio to ensure audio clarity at reduced levels.

## 7.23

# Wi-Fi

You can connect your radio to a Wi-Fi network for wireless programming and SmartConnect features. Your service administrator programs the Wi-Fi Service Set Identifier (SSID) or network name that your radio can connect to.

### 7.23.1

## Turning Wi-Fi On or Off

### Procedure:

Turning Wi-Fi<sup>®</sup> on or off using the preprogrammed button:

- a. To toggle the Wi-Fi on or off, press the preprogrammed **Wi-Fi** button.

This button must be preprogrammed by a qualified radio technician. Check with your dealer or system administrator for more information.

The display shows `WIFI ON` or `WIFI OFF`.

### 7.23.2

## Selecting WiFi Network

This feature allows you to view and select the available WiFi network.

### Procedure:

1. Press the **Menu Select** button directly below `WiFi` to enter WiFi screen.
2. Press the **Menu Select** button directly below `On` to turn on the WiFi.  
Radio starts searching for available network.
3. Press the **Menu Select** button directly below `List`.

Radio displays available network selection and the network signal strength.

If the radio displays `No network available`, press the **Menu Select** button directly below `RefreshRFSH` to search for available networks.

4. Press or to scroll through the list and press **Menu Select** button directly below `sel` to connect to the selected network.

**Result:** Radio displays the WiFi status, the selected network, and the signal strength.



**NOTE:** The **List** and `RefreshRFSH` buttons are not available when WiFi is searching or connecting to network.

### 7.23.3

## Checking the Wi-Fi Configuration and Status of the Radio

### Procedure:

Long press the preprogrammed **Wi-Fi** button.

The display shows the current status of the Wi-Fi as described next.

#### **WF SRCHG**

Looking for available Wi-Fi networks that have been preprogrammed into the radio.

#### **WF CNTG**

In the process of connecting to a found Wi-Fi network.

#### **WF CNTD**

Connected to one of the preprogrammed Wi-Fi networks.

#### **NO SERVICE**

No available networks or connection with one of the networks failed.

If the radio is Wi-Fi connected, you see a Wi-Fi signal strength indicator,  on the top display.

### 7.24

## Utilities

This chapter explains the operations of the utility functions available in your radio.

### 7.24.1

## Using the Flip Display

**When and where to use:** This feature allows you to flip the content of the top display upside down. It is particularly useful when you would like to read the top display while the radio is still in the carry holder attached to your belt.

### Procedure:

To flip the display, press and hold the programmed **Light/Flip** button.

### 7.24.2

## Selecting a Basic Zone Bank

**Prerequisites:** The Basic Zone Select feature must be programmed to the **3-Position A/B/C Switch**, while the Basic Zone Bank feature must be programmed to any **side** button or **Top (Orange)** button to use this feature.

**When and where to use:** This feature allows twice as many zones to be accessed from a switch, doubling the amount of switch positions.

**Procedure:**

Use the programmed **Basic Zone Bank** button to toggle the position between Bank 1 and Bank 2.

The top display shows the status icons (A, B, C, D, E, or F) or the zone name based on the bank and switch position selected.



**NOTE:** See the [Basic Zone Bank 1](#) and [Basic Zone Bank 2](#) icons for more information on the [Status Icons](#).

### 7.24.3

## Selecting the Power Level

This feature enables you to select the power level at which your radio transmits. The radio always turns on to the default setting. These reduced transmit power level settings do not affect the receiving performance of your radio, nor diminish the overall quality of the audio and data functionality of the radio given the following conditions. Power level **Low** enables a shorter transmitting distance to conserve power. Power level **High** enables a longer transmitting distance.

**Prerequisites:** This feature must be preprogrammed by a qualified radio technician.

**Procedure:**

Use the preprogrammed **Transmit Power Level** switch to toggle the power level between low and high power.

**Result:**

The display shows **LOW PWR** and the low power icon or the display shows **HIGH PWR** and the high power icon.

### 7.24.4

## Controlling the Display Backlight

You can enable or disable the radio display backlight as needed, if poor light conditions make the display or keypad difficult to read.

You can also maintain a minimum backlight level on the radio front display, depending on how your radio is programmed.



**NOTE:** The backlight setting also affects the **Menu Select** buttons, the **Navigation** button, and the **keypad** backlighting accordingly.

The backlight remains on for a programmed time before it automatically turns off completely or returns to the minimum backlight level.

**Procedure:**

Perform one of the following actions:

- 

### 7.24.5

## Locking and Unlocking the Keypad and Controls

You can lock the keypad, programmable buttons, rotary knobs, and switches of your radio to avoid inadvertent entry.

Check with your dealer or qualified technician for best selection to suit your usage.

**Procedure:**

1. Toggle the programmed **Keypad/Control Lock** button or switch to on.
2. Toggle again to unlock the controls.

#### 7.24.6

## Turning Voice Mute On or Off

This feature allows you to mute the voice transmission of the current zone and channel.

**When and where to use:**

**Procedure:**

Turning Voice Mute off or on using the preprogrammed **Voice Mute** button:

- a. To turn the feature off or on, press the preprogrammed **Voice Mute** button.

**Result:** The display shows momentary `VMUT OFF`, and you hear a short tone, indicating that the feature is disabled or the display shows momentary `VMUT ON`, and you hear a short tone, indicating that the feature is enabled.

#### 7.24.7

## Using the Time-Out Timer

**When and where to use:** This feature turns off the transmitter of your radio. You cannot transmit longer than the preset timer setting.

If you attempt to do so, the radio automatically stops your transmission, and you hear a talk-prohibit tone.

The timer is defaulted at 60 seconds, but it can be preprogrammed from 15 to 465 seconds, in 15-second intervals, or it can be disabled entirely for each radio mode, by a qualified radio technician.



**NOTE:** You hear a brief, low-pitched, warning tone four seconds before the transmission times out.

**Procedure:**

1. Hold down the **PTT** button longer than the preprogrammed time.  
You hear a continuous talk prohibit tone. The transmission is cut off and the LED goes out.
2. Release the **PTT** button.  
The timer resets.
3. To re-transmit, press the **PTT** button.  
The time-out timer restarts and the LED lights up solid red.

#### 7.24.8

## Conventional Squelch Operation

This feature filters out unwanted calls with low signal strength or channels that have a higher than normal background noise.

## Analog Options

Tone Private Line, Digital Private-Line, and carrier squelch is available and programmed per channel.

| Option                                    | Result                                    |
|---|---|
| Carrier squelch                           | You hear all traffic on a channel.        |
| Tone Private Line or Digital Private-Line | The radio responds only to your messages. |

## Digital Options

One or more of the following options can be programmed in your radio. For more information, contact your system administrator.

| Option                           | Result   |
|----------------------------------|--|
| Digital Carrier-Operated Squelch | You hear all digital traffic.  |
| Normal Squelch                   | You hear any digital traffic having the correct network access code.                       |
| Selective Switch                 | You hear any digital traffic having the correct network access code and correct talkgroup. |

### 7.24.9

## Using the PL Defeat Feature

This feature allows you to override any coded squelch programmed to a channel. Your radio also unmutes any digital activity on a digital channel. When this feature is active, the Carrier Squelch status indicator is displayed.

### Procedure:

Place the programmed **PL Defeat** switch in the PL Defeat position.

One of the following indications occurs :

- Your radio plays the active transmission on the channel.
- If no activity is present, your radio is muted.

### 7.24.10

## Digital PTT ID Support

This feature allows you to see the radio ID (number) of the radio from whom you are currently receiving a transmission. The receiving radio and the dispatcher can view the ID, which consists of up to a maximum of eight characters.

The ID number of your radio is also automatically sent every time you press the **PTT** button. This feature is programmed per channel. For digital voice transmissions, the ID of your radio is sent continuously during the voice message.

### 7.24.11

## Smart PTT (Conventional Only)

Smart PTT is a per-personality, programmable feature used to keep radio users from talking over other radio conversations. When Smart PTT is enabled in your radio, you cannot transmit on an active channel.

The following table shows the variations of Smart PTT.

| Mode   | Description   |
|--|---|
| Transmit Inhibit on Busy Channel with Carrier            | You cannot transmit if traffic is detected on the channel.  |
| Transmit Inhibit on Busy Channel with Wrong Squelch Code | You cannot transmit on an active channel with a squelch code or (if secure-equipped) encryption key other than your own. If the PL code is the same as yours, the transmission is not prevented.  |
| Quick-Key Override                                       | Your radio must be programmed to allow you to use Quick-Key Override. This feature works with either one of the two above variations. You can override the transmit-inhibit state by quick-keying the radio (press <b>PTT</b> button twice within the programmed time limit). |

### 7.24.12

## Transmit Inhibit

The Transmit Inhibit feature allows you to stop all transmission including voice and data. The radio can receive messages but is not able to reply the acknowledgment request of the received message.

This feature is available for APCO 25 Trunking, Type II Trunking, and Conventional operations for all APX radios.

You can physically control the transmission of the radio especially during operation in hazardous environments. An environment is considered hazardous if radio transmission could initiate an explosion or other dangerous reactions.

### 7.24.12.1

## Enabling Transmit Inhibition

### Procedure:

Press the **Transmit Inhibit** programmable button.

 **NOTE:** If the user has disabled TX Inhibit using the menu and then moves the switch to the position where TX Inhibit is enabled, the new value overwrites the menu value.

The display shows `Tx inhibit on`. You hear a sequence of short, low-high tones to indicate that transmission is inhibited.

**Result:** Pressing **PTT** triggers the radio sounds a constant short, low-pitched tone (reject tone).

 **NOTE:** The status of the Transmit Inhibit does not change after the radio powers up.

## 7.24.12.2

# Disabling Transmit Inhibition

### Procedure:

Press the Transmit Inhibit programmable button.



**NOTE:** If the user has disabled TX Inhibit using the softkey and then moves the switch to the position where TX Inhibit is enabled, the new value overwrites the menu value.

The display shows `Tx inhibit off`. You hear a sequence of short, high-low tone (Transmit Inhibit Off tone) to indicate that the transmission is back to normal operation.

## Chapter 8

# Accessories

Not all accessories are FCC certified to operate with all radio models, band splits, or both. See the radio price pages for a list of FCC certified accessories or contact your sales representative for accessory compatibility.

See <https://www.motorolasolutions.com> to know more about the accessories supported by this radio.



# Legal and Compliance Statements

## Disclaimer

The information in this document is carefully examined, and is believed to be entirely reliable. However, no responsibility is assumed for inaccuracies.

Furthermore, Motorola Solutions reserves the right to change any products to improve readability, function, or design. Motorola Solutions does not assume any liability arising out of the applications or use of any product or circuit described herein; nor does it cover any license under its patent rights, nor the rights of others.

## Supplier's Declaration of Conformity

Per FCC CFR 47 Part 2 Section 2.1077(a)



Responsible Party

Name: Motorola Solutions, Inc.

Address: 2000 Progress Pkwy, Schaumburg, IL 60196-1078, U.S.A.

Phone Number: 1-800-927-2744

Hereby declares that the product:

Model Name: **APX 8000XE**

conforms to the following regulations:

FCC Part 15, subpart B, section 15.107(a), 15.107(d), and section 15.109(a)

### **Class B Digital Device**

As a personal computer peripheral, this device complies with Part 15 of the FCC Rules. Operation is subject to the following two conditions:

1. This device may not cause harmful interference, and

2. This device must accept any interference received, including interference that may cause undesired operation.



**NOTE:**

This equipment has been tested and found to comply with the limits for a Class B digital device, pursuant to part 15 of the FCC Rules. These limits are designed to provide reasonable protection against harmful interference in a residential installation. This equipment generates, uses, and can radiate radio frequency energy and, if not installed and used in accordance with the instructions, may cause harmful interference to radio communications. However, there is no guarantee that interference will not occur in a particular installation.

If this equipment does cause harmful interference to radio or television reception, which can be determined by turning the equipment off and on, the user is encouraged to try to correct the interference by one or more of the following measures:

- Reorient or relocate the receiving antenna.
- Increase the separation between the equipment and receiver.
- Connect the equipment into an outlet on a circuit different from that to which the receiver is connected.
- Consult the dealer or an experienced radio or TV technician for help.

## Important Safety Information

### RF Energy Exposure and Product Safety Guide for Portable Two-Way Radios



**ATTENTION:**

**This radio is restricted to Occupational use only.**

Before using the radio, read the RF Energy Exposure and Product Safety Guide for Portable Two-Way Radios which contains important operating instructions for safe usage and RF energy awareness and control for Compliance with applicable standards and Regulations.

For a list of Motorola Solutions-approved antennas, batteries, and other accessories, visit the following website:

<https://www.motorolasolutions.com>

*Under Innovation, Science, and Economic Development Canada (ISED) regulations, this radio transmitter may only operate using an antenna of a type and maximum (or lesser) gain approved for the transmitter by ISED. To reduce potential radio interference to other users, the antenna type and its gain should be so chosen that the equivalent isotropically radiated power (e.i.r.p.) is not more than that necessary for successful communication.*

*This radio transmitter is approved by ISED to operate with a Motorola Solutions-approved antenna with the maximum permissible gain and required antenna impedance for each antenna type indicated. Antenna types not included in this list, having a gain greater than the maximum gain indicated for that type, are strictly prohibited for use with this device.*

## Notice to Users (FCC and ISED)

This device complies with Part 15 of the FCC rules and Innovation, Science, and Economic Development Canada's (ISED) license-exempt RSS's per the following conditions:

- This device may not cause harmful interference.
- The device must accept any interference received, including interference that may cause undesired operation.

- Changes or modifications made to this device, not expressly approved by Motorola Solutions, could void the authority of the user to operate this equipment.

## FCC Licensing Information

This device complies with Parts 90 and 15 of the Federal Communications Commission (FCC) Rules.

Operation is subject to the condition that this device does not cause harmful interference. The radio operates on radio frequencies that are regulated by the Federal Communications Commission (FCC). To transmit on these frequencies, you are required to have a license issued by the FCC. Application is made available on FCC Form 601 and Schedules D, H, and Remittance Form 159.

To obtain these FCC forms, request document 000601 which includes all forms and instructions. If you wish to have the document faxed, mailed, or have questions, use the following contact information.

### Fax

Contact the Fax-On-Demand system at 1-202-418-0177

### Mail

Call the FCC forms hotline at 1-800-418-FORM or 1-800-418-3676

### Contact

For questions regarding FCC license, contact 1-888-CALL-FCC, 1-888-225-5322, or <http://www.fcc.gov>.

Before filling out your application, you must decide which frequency you can operate on. For questions on determining the radio frequency, call Motorola Solutions Product Services at: 1-800-448- 6686. Changes or modifications not expressly approved by Motorola Solutions may void the user authority granted by the FCC to operate this radio and should not be made. To comply with FCC requirements, transmitter adjustments should be made only by or under the supervision of a person certified as technically qualified to perform transmitter maintenance and repairs in the private land mobile and fixed services as certified by an organization representative of the user of those services.

Replacement of any transmitter component such as crystal, semiconductor, and others not authorized by the FCC equipment authorization for this radio could violate FCC rules.



**NOTE:** Use of this radio outside the country where it was intended to be distributed is subject to government regulations and may be prohibited.

## Applying for Canadian License

The operation of your Motorola Solutions radio is subject to the Radio communications Act and must comply with rules and regulations of the Federal Government's department of Innovation, Science, and Economic Development Canada (ISED). ISED requires that all operators using Private Land Mobile frequencies obtain a radio license before operating their equipment.

**Prerequisites:** Obtain the latest Canadian License Application form at [http://www.ic.gc.ca/ic\\_wp-pa.htm](http://www.ic.gc.ca/ic_wp-pa.htm).

### Procedure:

1. Fill in the items as per the instructions. Be sure to print legibly.  
If you need additional space for any item, use the reverse side of the application.
2. Make a copy of your files.
3. Prepare a cheque or money order payable to the "Receiver General for Canada", for an amount for each radio purchased.  
The license is renewed on April 1st each year, and issued for a period of 12 months.
4. Mail your completed application along with your cheque or money order to the closest ISED office.

# Maritime Radio Use in the VHF Frequency Range

## Special Channel Assignments

### Emergency Channel

If you are in imminent and grave danger at sea and require emergency assistance, use VHF Channel 16 to send a distress call to nearby vessels and the United States Coast Guard. Transmit the following information, in this order:

1. "MAYDAY, MAYDAY, MAYDAY."
2. "THIS IS \_\_\_\_\_, CALL SIGN \_\_\_\_\_." State the name of the vessel in distress 3 times, followed by the call sign or other identification of the vessel, stated 3 times.
3. Repeat "MAYDAY" and the name of the vessel.
4. "WE ARE LOCATED AT \_\_\_\_\_." State the position of the vessel in distress, using any information that will help responders to locate you, e.g.:
  - latitude and longitude
  - bearing (state whether you are using true or magnetic north)
  - distance to a well-known landmark
  - vessel course, speed, or destination
5. State the nature of the distress.
6. Specify what kind of assistance that you need.
7. State the number of persons on board and the number needing medical attention, if any.
8. Mention any other information that would be helpful to responders, such as type of vessel, vessel length and/or tonnage, hull color, etc.
9. "OVER."
10. Wait for a response.
11. If you do not receive an immediate response, remain by the radio, and repeat the transmission at intervals until you receive a response. Be prepared to follow any instructions given to you.

### Non-Commercial Call Channel

For non-commercial transmissions, such as fishing reports, rendezvous arrangements, repair scheduling, or berthing information, use **VHF Channel 9**.

### Operating Frequency Requirements

A radio designated for shipboard use must comply with Federal Communications Commission Rule Part 80 as follows:

- on ships subject to Part II of Title III of the Communications Act, the radio must be capable of operating on the 156.800 MHz frequency.
- on ships subject to the Safety Convention, the radio must be capable of operating:

- in the simplex mode on the ship station transmitting frequencies specified in the 156.025–157.425 MHz frequency band, and
- in the semiduplex mode on the two frequency channels specified in the table below.



**NOTE:**

Simplex channels 3, 21, 23, 61, 64, 81, 82, and 83 cannot be lawfully used by the general public in US waters.

Additional information about operating requirements in the Maritime Services can be obtained from the full text of FCC Rule Part 80 and from the US Coast Guard.

**Table 5: VHF Marine Channel List**

| Channel Number | Frequency (MHz) |         |
|----------------|-----------------|---------|
|                | Transmit        | Receive |
| 1              | 156.050         | 160.650 |
| 2              | 156.100         | 160.700 |
| *              | 156.150         | 160.750 |
| 4              | 156.200         | 160.800 |
| 5              | 156.250         | 160.850 |
| 6              | 156.300         | –       |
| 7              | 156.350         | 160.950 |
| 8              | 156.400         | –       |
| 9              | 156.450         | 156.450 |
| 10             | 156.500         | 156.500 |
| 11             | 156.550         | 156.550 |
| 12             | 156.600         | 156.600 |
| 13**           | 156.650         | 156.650 |
| 14             | 156.700         | 156.700 |
| 15**           | 156.750         | 156.750 |
| 16             | 156.800         | 156.800 |
| 17**           | 156.850         | 156.850 |
| 18             | 156.900         | 161.500 |
| 19             | 156.950         | 161.550 |
| 20             | 157.000         | 161.600 |
| *              | 157.050         | 161.650 |
| 22             | 157.100         | 161.700 |
| *              | 157.150         | 161.750 |
| 24             | 157.200         | 161.800 |
| 25             | 157.250         | 161.850 |
| 26             | 157.300         | 161.900 |
| 27             | 157.350         | 161.950 |

MN002667A01-BB  
 Maritime Radio Use in the VHF Frequency Range

|      |         |         |
|------|---------|---------|
| 28   | 157.400 | 162.000 |
| 60   | 156.025 | 160.625 |
| *    | 156.075 | 160.675 |
| 62   | 156.125 | 160.725 |
| 63   | 156.175 | 160.775 |
| *    | 156.225 | 160.825 |
| 65   | 156.275 | 160.875 |
| 66   | 156.325 | 160.925 |
| 67** | 156.375 | 156.375 |
| 68   | 156.425 | 156.425 |
| 69   | 156.475 | 156.475 |
| 71   | 156.575 | 156.575 |
| 72   | 156.625 | –       |
| 73   | 156.675 | 156.675 |
| 74   | 156.725 | 156.725 |
| 75   | ***     | ***     |
| 76   | ***     | ***     |
| 77** | 156.875 | –       |
| 78   | 156.925 | 161.525 |
| 79   | 156.975 | 161.575 |
| 80   | 157.025 | 161.625 |
| *    | 157.075 | 161.675 |
| *    | 157.125 | 161.725 |
| *    | 157.175 | 161.775 |
| 84   | 157.225 | 161.825 |
| 85   | 157.275 | 161.875 |
| 86   | 157.325 | 161.925 |
| 87   | 157.375 | 161.975 |
| 88   | 157.425 | 162.025 |



**NOTE:**

\* Simplex channels 3, 21, 23, 61, 64, 81, 82, and 83 cannot be **lawfully used** by the general public in US waters.

\*\* Low power (1 W) only.

\*\*\* Guard band.



**NOTE:** A – in the Receive column indicates that the channel is transmitted only.

## Declaration of Compliance for the Use of Distress and Safety Frequencies

The radio equipment does not employ a modulation other than the internationally adopted modulation for maritime use when it operates on the distress and safety frequencies specified in RSS-182 Section 5.4.

## Technical Parameters for Interfacing External Data Sources

|   | <b>RS232</b>  | <b>USB</b>  | <b>SB9600</b> |
|---|---------------|-------------|---------------|
| <b>Input Voltage (Volts Peak-to-peak)</b> | 18 V          | 3.6 V       | 5 V           |
| <b>Max Data Rate</b>                      | 115 Kbps      | 12 Mbps     | 9.6 Kbps      |
| <b>Impedance</b>                          | 5000 $\Omega$ | 90 $\Omega$ | 120 $\Omega$  |

# Limited Warranty

## MOTOROLA SOLUTIONS COMMUNICATION PRODUCTS

### I. WHAT THIS WARRANTY COVERS AND FOR HOW LONG:

MOTOROLA SOLUTIONS, INC. (“MOTOROLA”) warrants the MOTOROLA SOLUTIONS manufactured Communication Products listed below (“Product”) against defects in material and workmanship under normal use and service for a period of time from the date of purchase as scheduled below:

|                                |              |
|--------------------------------|--------------|
| ASTRO APX8000XE Portable Units | One (1) Year |
| Product Accessories            | One (1) Year |

MOTOROLA SOLUTIONS, at its option, will at no charge either repair the Product (with new or reconditioned parts), replace it (with a new or reconditioned Product), or refund the purchase price of the Product during the warranty period provided it is returned in accordance with the terms of this warranty. Replaced parts or boards are warranted for the balance of the original applicable warranty period. All replaced parts of Product shall become the property of MOTOROLA SOLUTIONS.

This express limited warranty is extended by MOTOROLA SOLUTIONS to the original end user purchaser only and is not assignable or transferable to any other party. This is the complete warranty for the Product manufactured by MOTOROLA SOLUTIONS. MOTOROLA SOLUTIONS assumes no obligations or liability for additions or modifications to this warranty unless made in writing and signed by an officer of MOTOROLA SOLUTIONS.

Unless made in a separate agreement between MOTOROLA SOLUTIONS and the original end user purchaser, MOTOROLA SOLUTIONS does not warrant the installation, maintenance or service of the Product.

MOTOROLA SOLUTIONS cannot be responsible in any way for any ancillary equipment not furnished by MOTOROLA SOLUTIONS which is attached to or used in connection with the Product, or for operation of the Product with any ancillary equipment, and all such equipment is expressly excluded from this warranty. Because each system which may use the Product is unique, MOTOROLA SOLUTIONS disclaims liability for range, coverage, or operation of the system as a whole under this warranty.

MOTOROLA SOLUTIONS offers the following optional extended service contracts.

#### **DEVICE MANAGED SERVICES (DMS) ACCIDENTAL DAMAGE**

Provides for extended hardware repair coverage INCLUDING CHEMICAL, LIQUID, FIRE, AND OTHER PHYSICAL DAMAGE. Accidental damage coverage is available in conjunction with MOTOROLA SOLUTIONS’S standard Commercial Warranty and starts from the FIRST DAY the radio is put into use. Service performed under this plan consists of repair or replacement of the covered equipment as set forth in the terms and conditions. Repairs will be made only at the designated MOTOROLA SOLUTIONS repair depot. Local services are not included. MOTOROLA SOLUTIONS will pay the inbound shipping charges only with use of the MOTOROLA SOLUTIONS designated delivery service. MOTOROLA SOLUTIONS will pay for outbound shipping via MOTOROLA SOLUTIONS’S normal shipping methods.

#### **DEVICE MANAGED SERVICES (DMS) STANDARD HARDWARE**



Provides extended hardware normal wear and tear repair coverage beginning AFTER MOTOROLA SOLUTIONS'S standard Commercial Warranty period expires. Service performed under this plan consists of repair of the covered equipment as set forth in the terms and conditions. Repairs will be made only at the designated MOTOROLA SOLUTIONS repair depot. Local services are not included. MOTOROLA SOLUTIONS will pay for outbound shipping via MOTOROLA SOLUTIONS'S normal shipping methods.

## II. GENERAL PROVISIONS:

This warranty sets forth the full extent of MOTOROLA SOLUTIONS'S responsibilities regarding the Product. Repair, replacement, or refund of the purchase price, at MOTOROLA SOLUTIONS's option, is the exclusive remedy. THIS WARRANTY IS GIVEN IN LIEU OF ALL OTHER EXPRESS WARRANTIES. IMPLIED WARRANTIES, INCLUDING WITHOUT LIMITATION, IMPLIED WARRANTIES OF MERCHANTABILITY AND FITNESS FOR A PARTICULAR PURPOSE, ARE LIMITED TO THE DURATION OF THIS LIMITED WARRANTY. IN NO EVENT SHALL MOTOROLA SOLUTIONS BE LIABLE FOR DAMAGES IN EXCESS OF THE PURCHASE PRICE OF THE PRODUCT, FOR ANY LOSS OF USE, LOSS OF TIME, INCONVENIENCE, COMMERCIAL LOSS, LOST PROFITS OR SAVINGS OR OTHER INCIDENTAL, SPECIAL OR CONSEQUENTIAL DAMAGES ARISING OUT OF THE USE OR INABILITY TO USE SUCH PRODUCT, TO THE FULL EXTENT SUCH MAY BE DISCLAIMED BY LAW.

## III. STATE LAW RIGHTS:

SOME STATES DO NOT ALLOW THE EXCLUSION OR LIMITATION OF INCIDENTAL OR CONSEQUENTIAL DAMAGES OR LIMITATION ON HOW LONG AN IMPLIED WARRANTY LASTS, SO THE ABOVE LIMITATION OR EXCLUSIONS MAY NOT APPLY.

This warranty gives specific legal rights, and there may be other rights, which may vary from state to state.

## IV. HOW TO GET WARRANTY SERVICE:

You must provide proof of purchase (bearing the date of purchase and Product item serial number) in order to receive warranty service and, also, deliver or send the Product item, transportation and insurance prepaid, to an authorized warranty service location. Warranty service will be provided by MOTOROLA SOLUTIONS through one of its authorized warranty service locations. If you first contact the company which sold you the Product (e.g., dealer or communication service provider), it can facilitate your obtaining warranty service. You can also call MOTOROLA SOLUTIONS at 1-800-927-2744 US/Canada.

## V. WHAT THIS WARRANTY DOES NOT COVER:

1. Defects or damage resulting from use of the Product in other than its normal and customary manner.
2. Defects or damage from misuse, accident, water, or neglect.
3. Defects or damage from improper testing, operation, maintenance, installation, alteration, modification, or adjustment.
4. Breakage or damage to antennas unless caused directly by defects in material workmanship.
5. A Product subjected to unauthorized Product modifications, disassembles, or repairs (including, without limitation, the addition to the Product of non-MOTOROLA SOLUTIONS supplied equipment) which adversely affect performance of the Product or interfere with MOTOROLA SOLUTIONS's normal warranty inspection and testing of the Product to verify any warranty claim.
6. Product which has had the serial number removed or made illegible.
7. Rechargeable batteries if:
  - any of the seals on the battery enclosure of cells are broken or show evidence of tampering.

- the damage or defect is caused by charging or using the battery in equipment or service other than the Product for which it is specified.
8. Freight costs to the repair depot.
  9. A Product which, due to illegal or unauthorized alteration of the software/firmware in the Product, does not function in accordance with MOTOROLA SOLUTIONS's published specifications or the FCC certification labeling in effect for the Product at the time the Product was initially distributed from MOTOROLA SOLUTIONS.
  10. Scratches or other cosmetic damage to Product surfaces that does not affect the operation of the Product.
  11. Normal and customary wear and tear.

## VI. PATENT AND SOFTWARE PROVISIONS:

MOTOROLA SOLUTIONS will defend, at its own expense, any suit brought against the end user purchaser to the extent that it is based on a claim that the Product or parts infringe a United States patent, and MOTOROLA SOLUTIONS will pay those costs and damages finally awarded against the end user purchaser in any such suit, which are attributable to any such claim, but such defense and payments are conditioned on the following:

1. that MOTOROLA SOLUTIONS will be notified promptly in writing by such purchaser of any notice of such claim,
2. that MOTOROLA SOLUTIONS will have sole control of the defense of such suit and all negotiations for its settlement or compromise, and
3. should the Product or parts become, or in MOTOROLA SOLUTIONS' opinion be likely to become, the subject of a claim of infringement of a United States patent, that such purchaser will permit MOTOROLA SOLUTIONS, at its option and expense, either to procure for such purchaser the right to continue using the Product or parts or to replace or modify the same so that it becomes non-infringing or to grant such purchaser a credit for the Product or parts as depreciated and accept its return. The depreciation will be an equal amount per year over the lifetime of the Product or parts as established by MOTOROLA SOLUTIONS.

MOTOROLA SOLUTIONS will have no liability with respect to any claim of patent infringement, which is based upon the combination of the Product or parts furnished hereunder with software, apparatus or devices not furnished by MOTOROLA SOLUTIONS, nor will MOTOROLA SOLUTIONS have any liability for the use of ancillary equipment or software not furnished by MOTOROLA SOLUTIONS, which is attached to or used in connection with the Product. The foregoing states the entire liability of MOTOROLA SOLUTIONS with respect to infringement of patents by the Product or any parts thereof.

Laws in the United States and other countries preserve for MOTOROLA SOLUTIONS certain exclusive rights for copyrighted MOTOROLA SOLUTIONS software such as the exclusive rights to reproduce in copies and distribute copies of such MOTOROLA SOLUTIONS software. MOTOROLA SOLUTIONS software may be used in only the Product in which the software was originally embodied and such software in such Product may not be replaced, copied, distributed, modified in any way, or used to produce any derivative thereof. No other use including, without limitation, alteration, modification, reproduction, distribution, or reverse engineering of such MOTOROLA SOLUTIONS software or exercise of rights in such MOTOROLA SOLUTIONS software is permitted. No license is granted by implication, estoppel or otherwise under MOTOROLA SOLUTIONS patent rights or copyrights.

## VII. GOVERNING LAW:

This Warranty is governed by the laws of the State of Illinois, U.S.A.

## VIII. For Australia Only

This provision applies to products and services supplied by Motorola Solutions to consumers within the meaning of the Australian Consumer Law. This warranty is given by Motorola Solutions Australia Pty Limited (ABN16 004 742 312) of Tally Ho Business Park, 10 Wesley Court, Burwood East, Victoria. Our goods come with guarantees that cannot be excluded under the Australia Consumer Law. For major failures with the service, you are entitled:

- To cancel your service contract with us: and
- To a refund for the unused portion, or to compensation for its reduced value.

You are entitled to choose a replacement or refund for a major failure with goods. If a failure with the goods or service does not amount to a major failure, you are entitled to have the failure rectified in a reasonable time. If this is not done, you are entitled to a refund for the goods, and to cancel the contract for the service and obtain a refund of any unused portion. You are also entitled to be compensated for any other reasonably foreseeable loss or damage from a failure in the goods or service. If you have any queries, please call Motorola Solutions Australia at 1800 457 439. You may also visit our website: [https://www.motorolasolutions.com/en\\_xa/support.html](https://www.motorolasolutions.com/en_xa/support.html) for current warranty terms.