

TWO-WAY RADIO
DLR1060
NON-KEYPAD PORTABLE RADIO

USER GUIDE

en-US

January 2020

©2020 Motorola Solutions, Inc. All rights reserved.



MN006345A01-AA



MOTOROLA SOLUTIONS

Contents

Product Safety and RF Exposure Compliance.....	5
Batteries and Chargers Safety Information.....	6
Operational Safety Guidelines.....	6
Acoustic Safety.....	8
Computer Software Copyrights.....	9
Copyrights.....	10
Package Contents.....	11
Chapter 1: Introduction.....	12
Chapter 2: Maintenance.....	13
2.1 Use and Care.....	13
Chapter 3: Battery Features.....	15
3.1 Battery Specifications.....	15
3.2 Motorola Solutions Authorized Batteries.....	15
3.3 Battery Life.....	16
3.4 Battery Status.....	16
Chapter 4: Charging Method.....	17
4.1 Charging Stand-Alone Battery.....	17
4.2 Charging with the Drop-In Tray Single Unit Charger.....	17
4.3 Charging the Radio and the Battery Using a DLR 12-Pocket Multi-Unit Charger - Optional Accessory.....	18
4.4 Estimated Charging Time.....	19
4.5 Charger LED Indication.....	20
Chapter 5: Radio Overview.....	21
5.1 DLR1060 Controls and Indicators.....	21
5.2 Radio Specifications.....	23
Chapter 6: Getting Started.....	24
6.1 Attaching the Battery.....	24
6.2 Removing the Battery.....	24
6.3 Attaching the Holster.....	25
6.4 Turning the Radio On or Off.....	25
6.5 Adjusting the Volume.....	25
6.6 Checking Battery Status.....	26
Chapter 7: General Radio Operations.....	27
7.1 Transmitting and Receiving Calls.....	27
7.2 Talk Permit Tone.....	28
7.3 Talking to Group in Channel.....	28
7.4 Browsing or Selecting Channel.....	28
7.5 Starting Private Reply.....	29
7.6 Talk Range.....	29

7.7 Top Button Options.....	30	Chapter 9: Special Radio Call Features.....	46
7.8 Radio Status.....	30	9.1 Private Reply.....	46
Chapter 8: Advanced Configuration Mode.....	32	9.1.1 Starting Private Reply.....	50
8.1 Entering Advanced Configuration Mode.....	33	9.1.2 Private Reply Status Indicator.....	51
8.2 Browsing Advanced Configuration Options		9.2 Direct Call.....	52
.....	34	9.2.1 Direct Call Status Indicator.....	55
8.2.1 Entering Current PROFILE ID		9.3 Private Reply and Direct Call Frequently	
Number.....	34	Asked Questions.....	55
8.2.2 Changing PROFILE ID Number.....	35	9.4 Call All Available.....	58
8.2.3 Changing PROFILE ID Number		9.4.1 Call All Available Status Indicator..	62
in Sub-Menu.....	36	9.5 Page All Available.....	63
8.2.4 Confirming Modified PROFILE ID		9.5.1 Page All Available Status	
Number.....	37	Indicator.....	67
8.2.5 Setting Maximum Channels.....	38	Chapter 10: Customer Programming Software.....	69
8.2.6 Entering Top Button - Current		10.1 Setting Radio to Customer Programming	
Feature.....	39	Software.....	69
8.2.6.1 Browsing Top Button -		10.2 Customer Programming Software Basic	
Sub-Menu Options.....	40	Menu Instructions.....	70
8.2.7 Setting MIC Gain.....	41	Chapter 11: Cloning Mode.....	76
8.2.8 Setting Home Channel.....	42	11.1 Configuring Cloning Mode.....	76
8.2.9 Resetting to Factory Defaults.....	43	11.2 Cloning Mode in Multi-Unit Charger.....	77
8.2.9.1 Radio Factory Default			
Settings.....	44		

11.3 Configuring Cloning Mode Using Radio to Radio Cloning Cable.....	78
11.4 Troubleshooting Cloning Mode.....	80
11.5 Cloning Mode Using Wireless PROFILE ID Number	80
11.5.1 Configuring Cloning Mode Using Wireless PROFILE ID Number	81
Chapter 12: Troubleshooting.....	82
Appendix A: Accessories.....	87

Product Safety and RF Exposure Compliance

**CAUTION:**

This radio is restricted to occupational use only to satisfy FCC RF energy exposure requirements. Before using this product, read the Product Safety and RF Exposure booklet enclosed with your radio which contains important operating instructions for safe usage and RF energy awareness and control for compliance with applicable standards and regulations.

For a list of Motorola Solutions-approved antennas, batteries, and other accessories, visit <http://www.motorolasolutions.com>

Batteries and Chargers Safety Information

This document contains important safety and operating instructions. Read these instructions carefully and save them for future reference. Before using the battery charger, read all the instructions and cautionary markings on:

- the charger
- the battery
- the radio attached with battery
- To reduce risk of injury, charge only the rechargeable Motorola Solutions-authorized batteries. Charging the other batteries may cause explosion, personal injury, and damage.
- Use of accessories not recommended by Motorola Solutions may result in fire, electric shock, or injury.
- To reduce damage to the electric plug and cord, pull by plug rather than the cord when disconnecting the charger.
- An extension cord should not be used unless necessary. Use of an improper extension cord may result in fire and electric shock. If an extension cord must be used, make sure that the cord size is 18 AWG

for lengths up to 100 ft (30.48 m), and 16 AWG for lengths up to 150 ft (45.72 m).

- Do not operate the charger if it has been broken or damaged in any way. Take it to any qualified Motorola Solutions service representatives.
- Do not disassemble the charger; it is not repairable and replacement parts are not available. Disassembly of the charger may result in risk of electrical shock or fire.
- To reduce risk of electric shock, unplug the charger from the AC outlet before attempting any maintenance or cleaning.

Operational Safety Guidelines

- Turn off the radio while charging.
- The charger is not suitable for outdoor use. Use only in dry locations/conditions.
- Connect charger to an appropriately fused and wired supply of the correct voltage (as specified on the product only).
- Disconnect charger from line voltage by removing main plug.

- Connect the equipment to an outlet which is easy to access and near.
- For equipment using fuses, replacements must comply with the type and rating specified in the equipment instructions.
- Maximum ambient temperature around the power supply equipment must not exceed 40 °C (104 °F).
- Power output from the power supply unit must not exceed the ratings stated on the product label located at the bottom of the charger.
- Make sure the cord is not stepped on, tripped over, subjected to water, damage, or stress.

Acoustic Safety



CAUTION:

Exposure to loud noises from any source for extended periods of time may temporarily or permanently affect your hearing. The louder the radio volume, the less time is required before your hearing can be affected. Hearing damage from loud noises is sometimes undetectable at first and can have a cumulative effect.

To protect your hearing:

- Use the lowest volume necessary to do your job.
- Increase the volume only if you are in noisy surroundings.
- Reduce the volume before connecting headset or earpiece.
- Limit the amount of time you use headsets or earpieces at high volume.
- When using the radio without a headset or earpiece, do not place the radio speaker directly against your ear.
- If you experience hearing discomfort, ringing in your ears, or speeches that are muffled, you should stop

listening to your radio through your headset or earpiece, and have your hearing checked by your doctor.

Computer Software Copyrights

The Motorola Solutions products described in this manual may include copyrighted Motorola Solutions computer programs stored in semiconductor memories or other media. Laws in the United States and other countries preserve for Motorola Solutions certain exclusive rights for copyrighted computer programs, including, but not limited to, the exclusive right to copy or reproduce in any form the copyrighted computer program. Accordingly, any copyrighted Motorola Solutions computer programs contained in the Motorola Solutions products described in this manual may not be copied, reproduced, modified, reverse-engineered, or distributed in any manner without the express written permission of Motorola Solutions.

Furthermore, the purchase of Motorola Solutions products shall not be deemed to grant either directly or by implication, estoppel, or otherwise, any license under the copyrights, patents or patent applications of Motorola Solutions, except for the normal non-exclusive license to use that arises by operation of law in the sale of a product.

Copyrights

The AMBE+2™ voice compression software included in this product is protected by intellectual property rights including patent rights, copyrights and trade secrets of Digital Voice Systems, Inc. This voice compression technology is licensed solely for use as is within the Communications Equipment. US Patent Nos.: #8,595,002 B2, #8,359,197, #8,315,860, #8,200,497, #7,970,606, #6,912,495 B2, #6,199,037 B1, #5,826,222, #5,754,974, #5,701,390, and #5,715,365.

Package Contents

The following list encompasses the package content available:

- Radio
- Holster
- Lithium-Ion Battery
- Quick Reference Guide
- Drop-in Tray Charger with Power Adapter (Optional)
- Product Safety and RF Exposure Booklet
- Warranty Card

Introduction

This user guide covers the operation of your radios.

This radio is a product of Motorola Solutions' 90 years of experience as a world leader in the designing and manufacturing of communications equipment. This series provides cost-effective communications for businesses such as retail stores, restaurants, schools, construction sites, manufacturing, property and hotel management, and more. Motorola Solutions professional two-way radios are the perfect communications solution for all modern fast-paced industries.

Your dealer or system administrator may have customized your radio for your specific needs. Check with your dealer or system administrator for more information.



NOTICE:

Read this user guide carefully to ensure that you know how to properly operate the radio before use.

Business Radios,
Motorola Solutions
10 Wesley Court
Burwood East

Victoria 3151, Australia

For product-related questions, contact: 1-800-931-855 or visit us at: http://www.motorolasolutions.com/map/en_xa/dlr

Maintenance

This chapter explains the maintenance of the radio.

2.1

Use and Care



Do not immerse radio in water



Use a soft damp cloth to clean the exterior



Do not use alcohol or cleaning solutions



Do not place more than seven turned on radio, too close to each other in a container

If the radio is submerged in water,

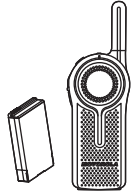

Turn the radio off and re-
move the battery



Dry with soft cloth



Do not use radio until it is
completely dry

-

-

Battery Features

The radio comes with a rechargeable Lithium-ion (Li-ion) battery. For optimum capacity and performance, ensure your battery is fully charged before first use.

3.1

Battery Specifications

Battery life is determined by several factors. The critical ones are overcharging of batteries and the average depth of discharge each cycle. Typically, the greater the overcharge and the deeper the average discharge, the fewer cycles a battery lasts. For example, a battery which is overcharged and discharged 100 % for several times a day, lasts fewer cycles than a battery that overcharges less and is discharged to 50 % per day. Battery with minimal overcharge and has an average of 25 % discharge, lasts even longer.

Motorola Solutions batteries are designed specifically to be used with a Motorola Solutions charger and vice versa. Charging batteries with non-Motorola Solutions equipment may lead to battery damage and void the battery warranty. Whenever possible, maintain the battery temperature to 77 °F (25 °C) (room temperature). Charging a cold battery

(below 50 °F [10 °C]) may result in leakage of electrolyte and ultimate failure of the battery. Charging a hot battery (above 95 °F [35 °C]) results in reducing discharge capacity and affecting the performance of the radio. Motorola Solutions rapid-rate battery chargers contain a temperature-sensing circuit to ensure that batteries are charged within the temperature limits.



NOTICE:

Batteries with different capacities and operational life may be available in the future.

3.2

Motorola Solutions Authorized Batteries

Table 1: Motorola Solutions Authorized Batteries

Part Number	Description
HKNN4013_	Li-ion Battery 1800 mAh

3.3

Battery Life

The battery life lasts longer when the Battery Save feature is turned on. The Battery Save feature is enabled by default.

Table 2: Battery Life with Battery Save Feature On

Battery Type	Battery Save On
Standard	Up to 15 hours



NOTICE:

Battery life is estimated based on 5% transmit/5% receive/90% standby standard duty cycle.

3.4

Battery Status

This section provides information on the battery status.

Table 3: Battery Status

Battery Status	Battery Level	Voice Prompt or Tone
High	100 % – 71 %	“Battery level high”
Medium	70 % – 41 %	“Battery level medium”
Low	40 % – 11 %	“Battery level low”
Critical	10 % – 0 %	“Battery level critical”
Shutdown	0 %	Shutdown beeps

Charging Method

This chapter describes the methods you use to charge your radio.

4.1

Charging Stand-Alone Battery

- 1 Align the raised tab on each side of the battery with the corresponding groove on each side of the charger pocket.
- 2 Press the battery toward the rear of the pocket.

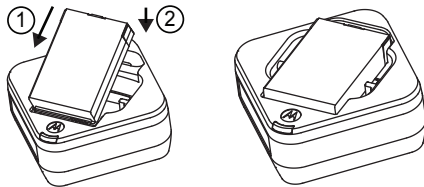

- 3 Slide the battery into the charger pocket, ensuring complete contact between the charger and battery contacts.

When the battery is in the pocket, the charger indicates the Battery Level status as shown in [Charger LED Indication on page 20](#) table. The red LED blinks to indicate that the battery is charging rapidly. The LED changes to a steady green light to indicate that the battery is nearly or fully charged.

4.2

Charging with the Drop-In Tray Single Unit Charger

The Single Unit Charger (SUC) is an optional accessory device.



NOTICE:

Turn off the radio before charging, and fully charge the battery before first use. It is best to charge at room temperature.

- 1 Place the SUC on a flat surface.

- 2 Insert the connector of the power supply into the port on the side of the SUC.
- 3 Plug the AC adapter into a power outlet.
- 4 Insert the radio into the SUC with the front of the radio facing the LED of the SUC. Ensure the radio is securely inserted all the way into the charger.

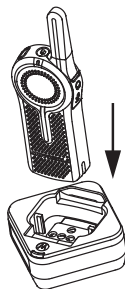

NOTICE:

For more information, see [Charger LED Indication on page 20](#) and [Operational Safety Guidelines on page 6](#).

The red LED on the SUC illuminates to indicate that the battery is charging.

4.3

Charging the Radio and the Battery Using a DLR 12-Pocket Multi-Unit Charger - Optional Accessory

The DLR 12-Pocket Multi-Unit Charger (MUC) allows drop-in charging of up to 12 radios or up to six radios and six stand-alone batteries. The batteries can be charged with the radios or removed and placed in the MUC separately. Each of the six charging pockets can hold a radio (with or without the Holster) or battery, but not both at the same time.

- 1 Place the MUC on a flat surface.
- 2 Insert the power cord plug into the MUC dual pin connector at the bottom of the MUC.
- 3 Plug the power cord into an AC outlet.
- 4 Turn off the radio.
- 5 Insert the radio or the battery into the charging pocket with the radio or the battery facing away from the contacts.

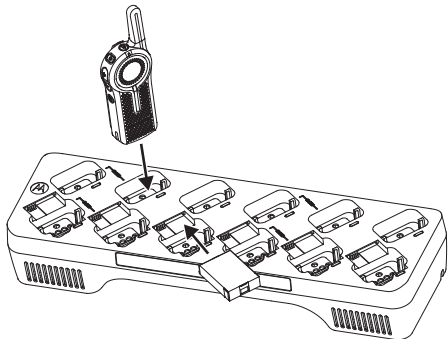

Estimated Charging Time

The following table provides the estimated charging time of the battery. For more information, see [Accessories on page 87](#).

Table 4: Estimated Charging Time

Charging Solutions	Estimated Charging Time
Standard	Standard Battery ≤ 3.50 Hours



NOTICE:

- The MUC clones up to two radios (two Source radios and two Target radios). For more information, refer to [Cloning Mode in Multi-Unit Charger on page 77](#).
- For more information on the MUC operation, refer to the Instruction Sheets provided with the MUC. For more information on the parts and their part numbers, refer to [Accessories on page 87](#).

4.5

Charger LED Indication

The following table describes the meaning of the charger LED indicator.

**NOTICE:**

Ensure the radio or the stand-alone battery is inserted correctly in the charger, and there is power to the outlet.

Indication	Status
Blink amber two times	Battery level is medium
Blink green three times	Battery level is high

Table 5: Charger LED Indication

Indication	Status
Green for approximately one second	Power On
Steady red	Charging
Steady green	Charged
Fast blinking red	Error ¹
Slowly blinking amber	Standby ²
Blink red one time	Battery level is low

¹ Re-position the battery pack to fix the error.

² Battery temperature is too warm or too cold or wrong power voltage is used.

Radio Overview

This chapter explains the buttons and functions to control the radio.

5.1

DLR1060 Controls and Indicators

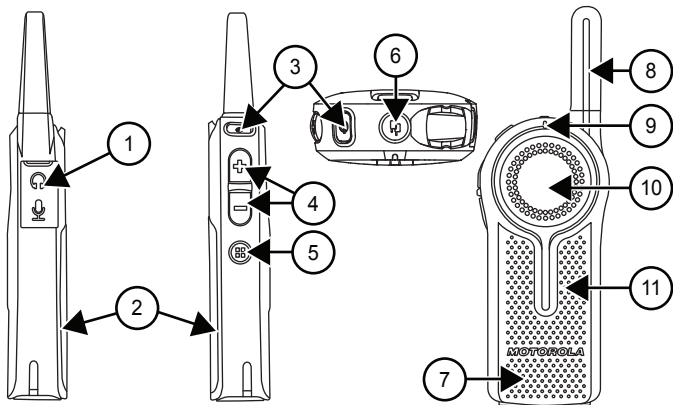

Figure 1: DLR1060 Controls and Indicators

Number	Description
1	Audio Accessory Connector Connects compatible audio accessories.
2	Lithium-ion (Li-ion) Battery For more information on the battery, refer to Battery Specifications on page 15 .
3	Power Button <ul style="list-style-type: none"> To turn the radio On/Off, long press the Power button. To check the battery status, short press the Power button.
4	Volume Control Button <ul style="list-style-type: none"> To increase the volume, press the Volume Up button. To decrease or mute the volume, press the Volume Down button.

Number	Description
5	<p>Channel/Menu Button</p> <p>In standard radio operation mode, the Channel/Menu button comes defaulted to channel function.</p> <ul style="list-style-type: none"> To change channels, press the Channel/Menu button. To browse channels, press the Volume Up or Volume Down button To exit, short press the PTT button. <p>In Advanced Configuration Mode, the Channel/Menu button gives access, and allows navigation to set up special features.</p>
6	<p>Top Button</p> <p>The radio Top button is defaulted to Private Reply feature.</p> <p>For more information on programming the Top button to other features, refer</p>

Number	Description
	to Special Radio Call Features on page 46 .
7	Speaker
8	<p>Antenna</p> <p>The antenna is non-removable.</p>
9	<p>Tx/Rx Indicator LED</p> <p>Indicates whether the radio is on stand-by, receiving, or transmitting.</p>
10	<p>Push-to-Talk (PTT) Button</p> <p>To talk, press the PTT button and wait to hear the Talk Permit Tone (TPT). The TPT is a quick double beep. Release it to listen.</p> <p>For more information, refer to Transmitting and Receiving Calls on page 27.</p>
11	Microphone

5.2

Radio Specifications

The radio specification is printed on the back of the radio.

Table 6: Radio Specifications

Model	Frequency Band	Transmit Power (Watts)	Number of Channels	Antenna
DLR1060	ISM 900 MHz	1 W EIRP	6	Non-removable

Getting Started

This section helps you to get familiar with the basic operations of the radio.

6.1

Attaching the Battery

- 1 Slide the latch at the top of the battery door to the unlock position, and lift the battery door at the center recess.
- a Align the battery contacts with the tabs in the battery compartment. Insert the contact side of the battery first, then press the battery down to secure in place.

Figure 2: Attaching the Battery

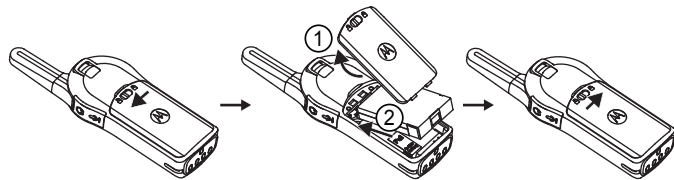

- 2 Put the battery door back on the radio.

- 3 Slide the latch to the lock position.

6.2

Removing the Battery

- 1 Turn the radio off.

- 2 Slide the latch at the top of battery door to the unlock position, and lift the battery door at the center recess.

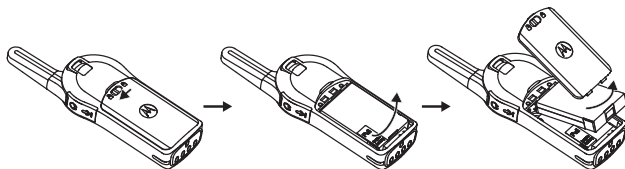

Figure 3: Removing a Li-Ion Battery

- 3 Pull the battery removal tab until the battery is disengaged from the battery compartment.

- 4 Pull the battery away from the radio.

6.3

Attaching the Holster

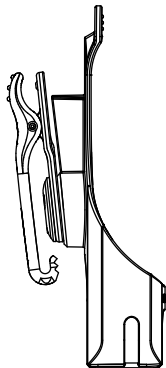

Figure 4: Holster

- 1 To insert the radio into the holster, press the radio against the back of the holster until the hook on the holster is inserted in the top recess.
-
- 2 To remove the radio from the holster, detach the hook of the holster from the top recess using the top tab, and slide the radio out from the holster.
-

6.4

Turning the Radio On or Off

- To turn on the radio, long press the **Power** button until the radio plays the power-up tone, and the Tx/Rx LED indicator blinks.
- To turn off the radio, long press the **Power** button until the radio power down tone is heard, and the Tx/Rx Indicator LED indicator turns off.



NOTICE:

By default, when the radio is turned on, it announces the current channel name and battery status.

6.5

Adjusting the Volume

There are 16 increments of volume. When you press the **Volume Up** or **Volume Down** buttons, you hear a beep at the current volume level. If your radio is receiving during volume interaction, you hear audio voice prompt from your radio, and the new volume instead of beeps.

- Press the **Volume Up** button to increase the volume, or the **Volume Down** button to decrease the volume.

- To mute, press and hold the **Volume Down** button (~2 seconds) until you hear “Mute” voice prompt from your radio.
- To maximize the volume, press and hold the **Volume Up** button (~2 seconds). The volume scrolls up fast to maximum volume. You hear the volume beeps increment as the volume increases.



NOTICE:

- Radio mute means setting the volume to the lowest level. This is to prevent the user from forgetting to unmute the radio.
- Do not hold the radio too close to the ear when the volume is high or when adjusting the volume.
- When using radio with earpiece, make sure to adjust the radio volume to the lowest volume before putting on the earpiece. For more information, refer to [Acoustic Safety on page 8](#). Use only Motorola Solutions approved accessories. For more information, refer to [Accessories on page 87](#).

Checking Battery Status

The battery level status are high, medium, low, and critical.

Short press the **Power** button.

For more information, refer to [Battery Status on page 16](#).

General Radio Operations

7.1

Transmitting and Receiving Calls

- 1 Press the **PTT** button to respond.



NOTICE:

Wait for the Talk Permit Tone (TPT) to end and speak. If you receive a busy tone, the channel is either not available, busy, or there is no user reachable within transmission range.

A quick double beep is heard.

- 2 Hold the radio vertically by 1 to 2 in. from mouth when speaking into the microphone.
- 3 Release the **PTT** button to listen.

Table 7: Tx/Rx LED Indicator

Indicator	Status
Slow blink- ing red	The radio is on standby.
Solid red	The radio is in transmission mode.
Fast blink- ing red	The radio is in receiving mode.

**IMPORTANT:**

Do not release the **PTT** button at any given time when talking on the radio. Whether you are transmitting using the **PTT** button or using an in-line **PTT** on the earpiece accessory, always ensure the **PTT** button is pressed firmly until the transmission is finished. Releasing the **PTT** button while transmitting and trying to immediately press the **PTT** button again causes the radio to give a loud denial tone.

Wait for two seconds and press **PTT** again to continue speaking. If you press the **PTT** button to transmit and a busy tone is received instead of a **TPT**, this means the channel is either not available, busy or there are no users reachable within transmission range.

7.2

Talk Permit Tone

Talk Permit Tone (TPT) is a quick distinctive double beep tone that sounds after you press the **PTT** button, indicating the channel is free to talk.

TPT ensures orderly communications by preventing radios from transmitting over ongoing conversations.

**NOTICE:**

To ensure your words are not cut off, always wait for the TPT before you start to speak.

7.3

Talking to Group in Channel

- 1 To transmit, press the **PTT** button.

Solid red Tx/Rx Indicator LED illuminates and the TPT is heard.

- 2 Before you speak, wait for the TPT.
-

7.4

Browsing or Selecting Channel

- 1 Press the **Channel/Menu** button until you hear "Channel <Number>" voice prompt from your radio.
-

- 2 To select channel, press the **Volume Up** button or **Volume Down** button.

Your hear selected channel voice prompt from your radio.

- 3 To exit *<Channel Change>*, press the **PTT** button or wait for the radio Channel/Menu timer to expire.

7.5

Starting Private Reply

The **Top** button is set to Private Reply feature by default. This feature allows two people to instantly connect privately after a group transmission is over.

- 1 To initiate a Private Reply, press the **Top** button during a group call.

The **Top** button LED blinks orange.

- 2 After a group call, press **PTT** button to call privately.

The **Top** button LED illuminates in solid orange.

- 3 Wait for the Talk Permit Tone to end and speak.



NOTICE:

There is a channel Hangtime after a Private transmission. By default, the Hangtime is set to 10 seconds.

7.6

Talk Range

Table 8: Talk Range

Talk Range		
Model	Industrial	Multi-Level
		Inside steel/concrete Industrial buildings
ISM 900 MHz	Up to 250,000 sq.ft	Up to 18 Floors

For a group of radio to communicate, the radios need to be on the same channel and have the same radio PROFILE ID number. The default PROFILE ID number is **0000**.

Channel

Current channel that the radio is using, depending on radio model.

PROFILE ID Number

The radio in your fleet (independent of the channels that users are assigned to) should use the same PROFILE ID. It is important to customize the PROFILE ID number in order to avoid interference from other users using the default **0000** number. In order to customize your radio fleet PROFILE ID, choose a four digit number and enter it using the radio Advanced Configuration Mode (Turn off the radio, press **PTT** → **Volume Up** → **Power** buttons at the same time, and hold until you hear

Programming Mode voice prompt from your radio. For

more information, refer to the [Advanced Configuration Mode on page 32](#).

7.7

Top Button Options

The **Top** button is programmed to Private Reply feature by default.

You can configure the **Top** button to other features such as Page All Available, Call Available, Direct Call and Mute.

For more information on **Top** button configuration, refer to [Advanced Configuration Mode on page 32](#).

7.8

Radio Status**Table 9: Radio Status**

Radio Status	Front LED Indicator	Top Button LED Indicator	Voice Prompt or Tone
Power-Up	Solid Red for 2 seconds	OFF	“Battery Level <Level>, Channel <Number>”

Radio Status	Front LED Indicator	Top Button LED Indicator	Voice Prompt or Tone
Power Off	Solid Red for 2 seconds	OFF	Power Off chirps
Fatal Error at Power-up	Double Blink Red	Single Blink Orange	Not Available
Channel Busy	Not Available	OFF	Busy tone
'Idle' Mode	Heartbeat Red	OFF	Not Available
Transmit (Tx) (standard group call)	Solid Red	OFF	Not Available
Receive (RX) (standard group call)	Fast Red Heartbeat	OFF	Not Available

Advanced Configuration Mode

Advanced Configuration Mode allows you to configure special settings in your radio without the need of programming cables or additional software.

Advanced Configuration Mode allows you to customize the following features.

- PROFILE ID Number
- Maximum Channels
- **Top** button
- Microphone (MIC) Gain
- Home Channel

Table 10: Advanced Configuration Mode Feature Customization

Feature	Description
PROFILE ID Number	Choose a 4-digit number (0000–9999) as your ra-

³ Only if enabled via CPS.

Feature	Description
	dio PROFILE ID Number. Customize the PROFILE ID Number to ensure interference free/private communications.
Maximum Channels	Choose the maximum number of channels you want to allow for your radio.
Top button	Set the Top button with one of the following features: Private Reply, Direct Call, Call All Available, Page All Available, Mute, Disabled.
MIC Gain	Choose between High, Medium, or Low MIC Gain to adjust the radio microphone sensitivity level to fit different users or noise environments.

Feature	Description
Home Channel	Choose the channel you want to designate as your main channel. Every time you change to a different channel and no activity is detected from the channel, the radio reverts to your home channel.

8.1

Entering Advanced Configuration Mode

To enter Advanced Configuration Mode, press **Power** → **PTT** → **Volume Up** buttons at the same time.

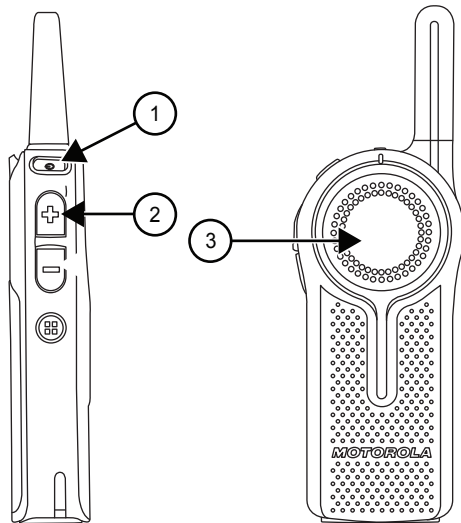

Number	Description
1	Power button
2	Volume Up button

Number	Description
3	PTT button

You hear "Programming Mode. Press Menu button to continue" voice prompt from your radio.

8.2

Browsing Advanced Configuration Options

- 1 Upon entering Advanced Configuration Mode, you hear "Programming Mode. Press Menu button to continue" voice prompt from your radio.
- 2 To browse through Advanced Configuration options, press **Channel/Menu** button.
- 3 To exit Advanced Configuration Mode, long press the **PTT** button.

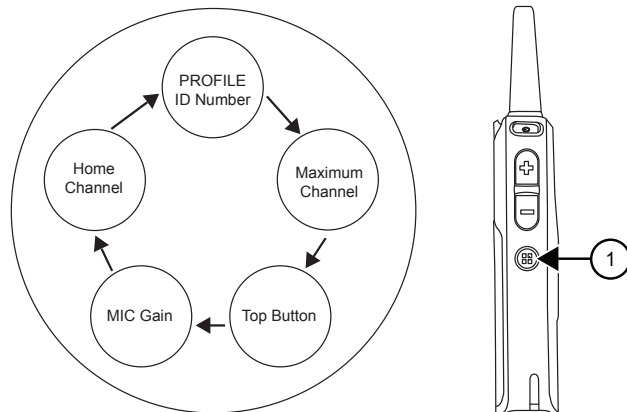

Figure 5: Advanced Configuration Options

Number	Description
1	Channel/Menu button

8.2.1

Entering Current PROFILE ID Number

- 1 Press the **Channel/Menu** button until you hear "PROFILE ID Number default is "0000". Change it to

avoid interferences and improve privacy" voice prompt from your radio to change it.

- 2 To enter the Profile ID number sub-menu, press the **Volume Up** button or **Volume Down** button.
- 3 To continue to the next Advanced Configuration option, press the **Channel/Menu** button.

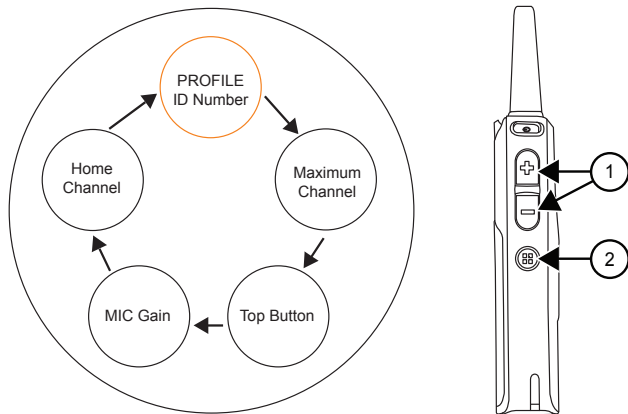

Figure 6: Profile ID Number - Current Value

Number

Description

1

Volume Up button or **Volume Down** button. Press to enter the PROFILE ID Number sub-menu

2

Channel/Menu button. Press to continue to the next Advanced Configuration option.

8.2.2

Changing PROFILE ID Number

- 1 To enter and change the PROFILE ID Number sub-menu, press the **Volume Up** button or **Volume Down** button.

You hear "There is 10,000 options of PROFILE ID Number to choose from (0000 – 9999)" voice prompt from your radio.

- 2 To change the first digit, press the **Volume Up** button or **Volume Down** button.
-
- 3 To continue to the next digit, press **Channel/Menu** button.

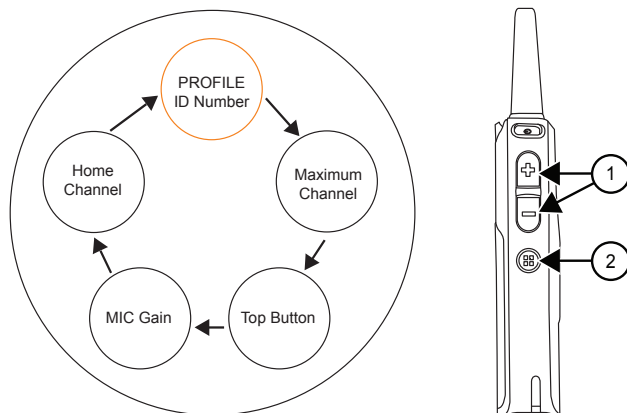

Figure 7: Profile ID Number

Number	Description
1	Volume Up button or Volume Down button.

Number	Description
	Press to change the first digit.
2	Channel/Menu button. Press to continue to the next digit.

8.2.3

Changing PROFILE ID Number in Sub-Menu

- 1 To change the current digit, press the **Volume Up** button or **Volume Down** button.
You hear the value voice prompt from your radio.
-
- 2 To continue to the next digit, press **Channel/Menu**.
-
- 3 Once you have entered the fourth digit, press the **Channel/Menu** button again to continue to the next Advanced Configuration option.



NOTICE:

You have the option to browse forward through the four digits using the **Channel/Menu** button. However, you do not have the option to browse backward through the four digits of PROFILE ID Number.

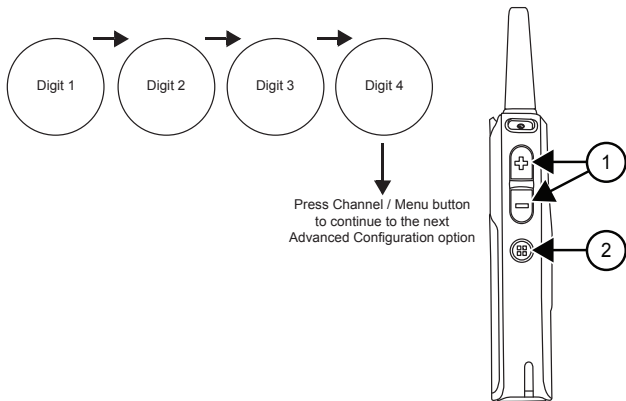

Figure 8: Profile ID Number in Sub-Menu

Number	Description
1	Volume Up button or Volume Down button.

Number

Description

2

Press to change the first digit.

Channel/Menu button. Press to continue to next digit. Once in the last digit, press the button again to continue to the next Advanced Configuration option.

8.2.4

Confirming Modified PROFILE ID Number

- 1 You hear the new PROFILE ID Number voice prompt from your radio when you have set the four digit PROFILE ID Number.

**NOTICE:**

If the four digit PROFILE ID number announced is not the correct number, press the **Channel/Menu** button, and cycle through the Advanced Configuration options until you return to the PROFILE ID number option to change the value.

- 2 To continue to the next Advanced Configuration option, press the **Channel/Menu** button.

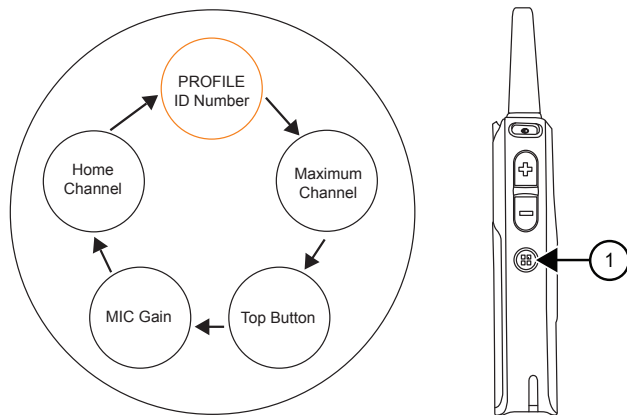

Figure 9: Modified PROFILE ID Number Confirmation

Number	Description
1	Channel/Menu button. Press to continue to the next Advanced Configuration option.
3	To exit the Advanced Configuration Mode, long press the PTT button.

8.2.5

Setting Maximum Channels

The maximum number of channels you can set up in your radio is according to your radio model. DLR1060 radio has maximum six channels.

- 1 Press the **Channel/Menu** button until your radio announces the current maximum number of channels and prompts you to change it.
- 2 To change the number of channels, press the **Volume Up** button or **Volume Down** button.
- 3 To continue to the next Advanced Configuration option, press the **Channel/Menu** button.

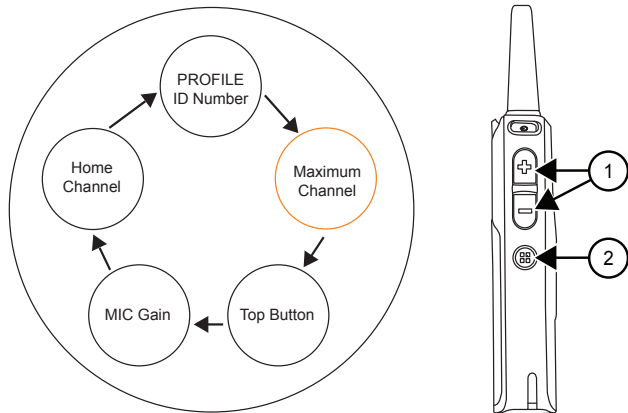

Figure 10: Maximum Channels Setup

Number	Description
1	Volume Up button or Volume Down button. Press to change the number of channels.
2	Channel/Menu button.

Number	Description
	Press to continue to the next Advanced Configuration option.

8.2.6

Entering Top Button - Current Feature

- 1 Press the **Channel/Menu** button until your radio announces the current **Top** button feature and prompts you to change it.
- 2 To enter the **Top** button sub-menu, press the **Volume Up** button or **Volume Down** button.
- 3 To continue to the next Advanced Configuration option, press the **Channel/Menu** button.

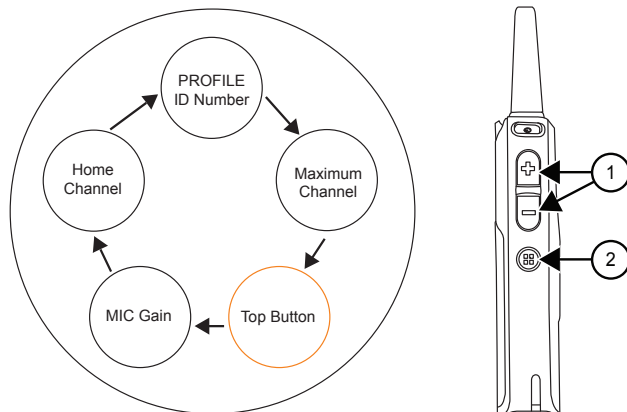

Figure 11: Top Button - Current Feature

Number	Description
1	Volume Up button or Volume Down button. Press to enter the Top button sub-menu.
2	Channel/Menu button. Press to continue to the next Advanced Configuration option.

8.2.6.1

Browsing Top Button - Sub-Menu Options

- 1 To browse through the different options in **Top** button sub-menu, press the **Volume Up** button or **Volume Down** button.

You hear voice prompts from your radio as you navigate through the feature.

- 2 To continue to the next Advanced Configuration option, press the **Channel/Menu** button.



NOTICE:

To use Direct Call option, you must enable the feature in CPS first. Otherwise **Top** button sounds an error tone even if you choose the option in the this menu.

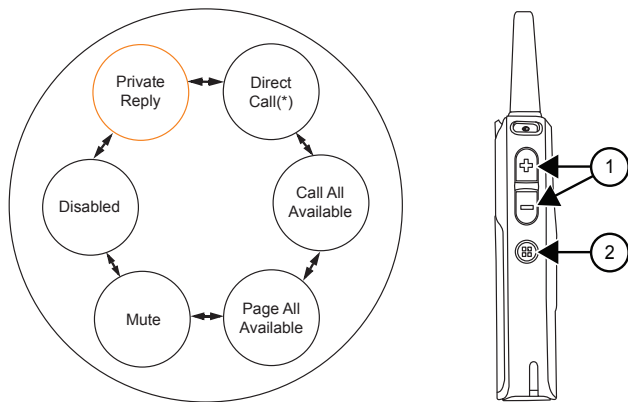

Figure 12: Top Button - Sub-Menu Options

Number	Description
1	Volume Up button or Volume Down button. Press to browse through the Top button option in sub-menu.
2	Channel/Menu button.

Number	Description
	Press to continue to the next Advanced Configuration option.

8.2.7

Setting MIC Gain

You can change your MIC Gain setting to low, medium, or high. The default setting for MIC Gain is medium.

- 1 Press the **Channel/Menu** button until your radio announces the MIC Gain setting and prompts you to change it.
- 2 To change the MIC Gain setting, press the **Volume Up** button or **Volume Down** button.
- 3 To continue to the next Advanced Configuration option, press the **Channel/Menu** button.

**NOTICE:**

You should only change the MIC Gain setting if other users complain that the volume from your radio is too low or too high. The default medium setting is appropriate for most users, so it can be left unchanged.

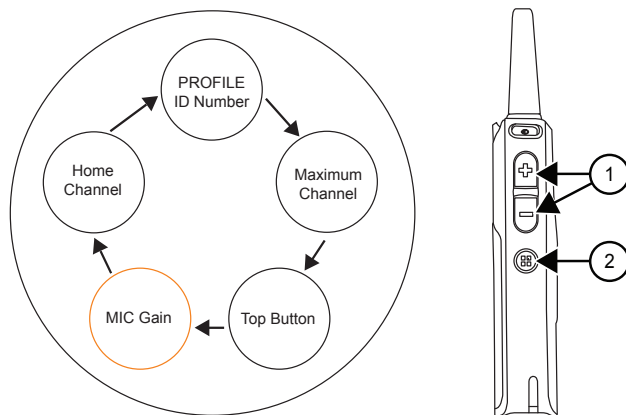

Figure 13: MIC Gain Setup

Number	Description
1	Volume Up button or Volume Down button.

Number	Description
	Press to change MIC Gain settings.
2	Channel/Menu button. Press to continue to the next Advanced Configuration option.

8.2.8

Setting Home Channel

You can change your Home Channel setting to Disabled or Channel number (or channel name if alias was set up in Customer Programming Software (CPS)). The default setting for Home Channel is Disabled.

- 1 Press the **Channel/Menu** button until your radio announces the Home Channel setting and prompts you to change it.
- 2 To change the Home Channel setting, press the **Volume Up** button or **Volume Down** button.

- 3 To go back to the first Advanced Configuration option – PROFILE ID Number, press the **Channel/Menu** button.



NOTICE:

When Home Channel is enabled and there is no activity detected from a channel for seven seconds, the radio reverts to Home Channel. This feature may not be appropriate if you need to frequently change channels throughout the day.

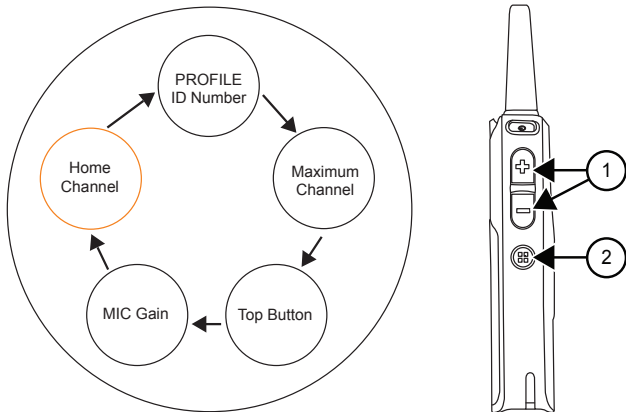

Figure 14: Home Channel Setup

Number	Description
1	Volume Up button or Volume Down button. Press to change Home Channel settings.
2	Channel/Menu button. Press to go back to the first Advanced Configuration option.

8.2.9

Resetting to Factory Defaults

To reset your radio to the original factory defaults, press **Power** → **PTT** → **Volume Down** → **Volume Up** buttons at the same time.

You hear resetting beeps and "Battery Level <battery level>, Channel <channel name>" voice prompt from your radio.

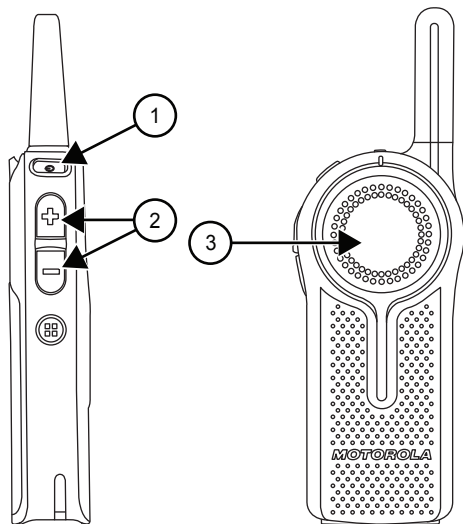

Number	Description
1	Power button
2	Volume Up button and Volume Down button
3	PTT button

8.2.9.1

Radio Factory Default Settings

Table 11: Radio Basic Feature Defaults

Radio Basic Feature	Default
Power up announcement	Battery Status and Channel Name
Quick press Power button	Battery Status
Number of channels	Set to maximum number of channels supported by the radio model
Channel/Menu button	Channel change only
Top button feature	Private Reply

Table 12: Radio Advanced Configuration Mode Defaults

Radio Basic Feature	Default
PROFILE ID Number lock	Off
Radio PROFILE ID Number	0000

Radio Basic Feature	Default
Maximum Channels	Set to maximum number of channels supported by the radio model
Direct Call	Off
MIC Gain	Medium
Home Channel	Disabled
Battery Save	On
Power Save	Off
Programmable button	Call All Available

**NOTICE:**

For other radio default setting, refer to Customer Programming Software (CPS).

Table 13: Radio Special Mode Defaults

Radio Special Mode	Default
Enable restore Factory Default reset	On
Enable Advanced Configuration Mode	On
Enable Cloning Mode	On

Special Radio Call Features

This topic explains DLR Radio Series special call features.

9.1

Private Reply

This feature allows two people to instantly connect privately after a group transmission.

Private Reply Scenario

User B is talking to a group of radios.

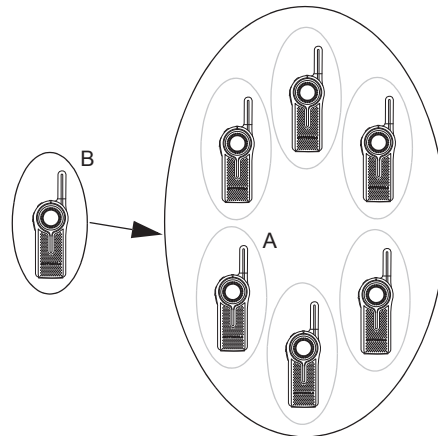

User A wants to talk to User B privately and presses the **Top** button to queue up.

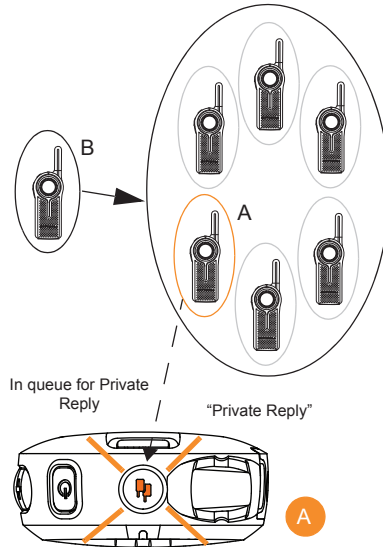
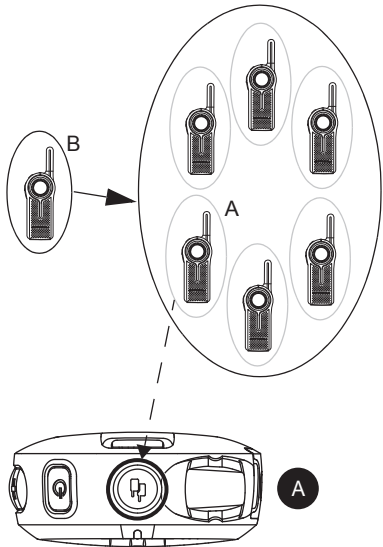

NOTICE:

Long pressing the **Top** button a second time cancels the Private Reply queue.

User A radio plays voice prompt “Private Reply” and the **Top** button starts blinking orange, showing user A is in queue waiting to talk privately to User B.

User B finishes talking to the Group while User A radio is still blinking orange indicating it is in queue for Private Reply call.

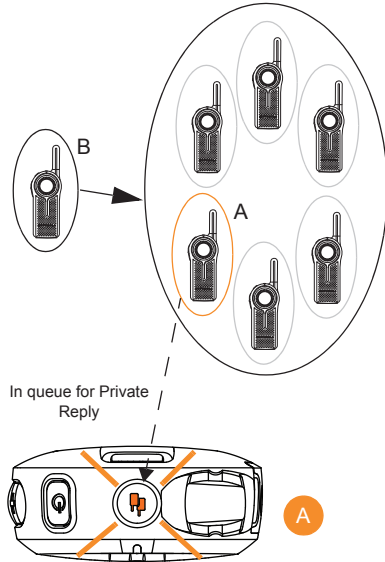

User A presses **PTT** button to talk privately to User B. The **Top** button LED indicator for both radio A and radio B illuminate solid orange. User B hears radio voice prompt "Private" and radio plays a distinctive Private TPT.

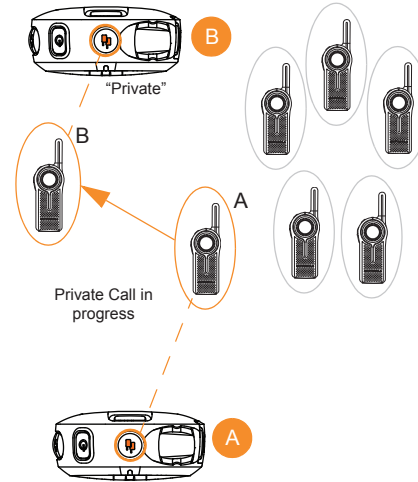

Whenever user A or B presses the **PTT** button to reply back, they are talking privately to each other. Nobody else hears them. Radio plays a distinctive Private TPT.

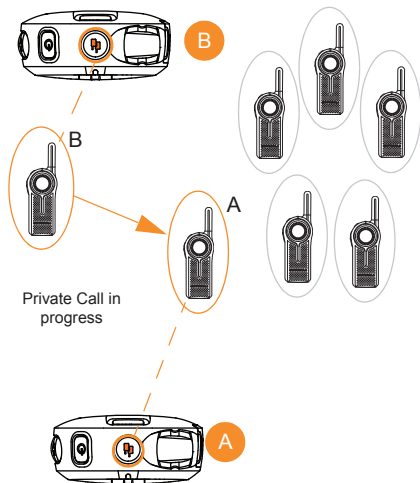

If either one of the radio users takes too long to push the **PTT** button and reply back, (the default “Private Hang Time” is 10 seconds), the radio times out and ends the private communication with voice prompt “Private Over” on both radios A and B. The **Top** button LED indicator goes off.

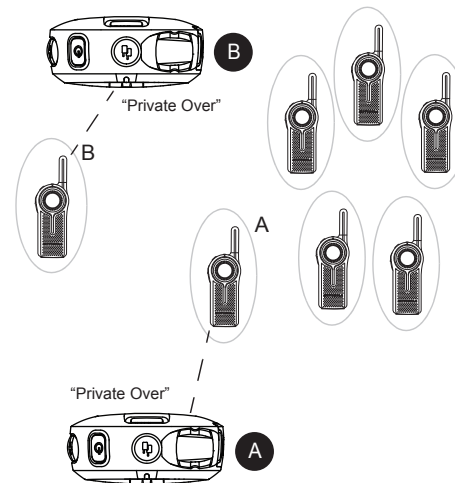

Radio user A (who initiated the Private Call), can also end the call at any time by long pressing the **Top** button. The radio plays voice prompt “Private Over” on both radio A and B to indicate that the private call is over. The **Top** button LED indicator turns off.

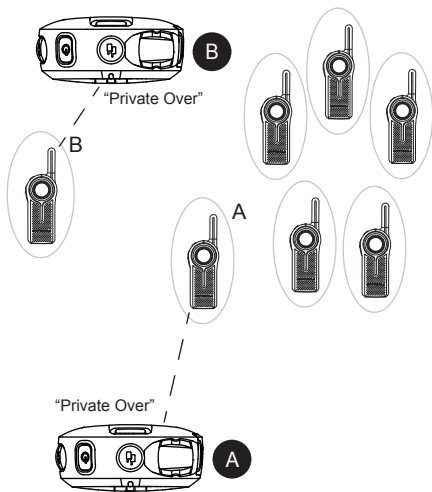

Radio users A and B join back the group transmission in their channel once the private call ends.

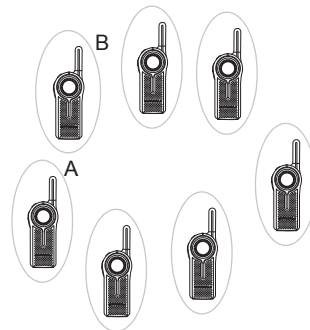

NOTICE:

You can set the “Private Hang Time” and “Group Hang Time” to different values using the CPS.

9.1.1

Starting Private Reply

This feature allows two people to instantly connect privately after a group transmission. The **Top** button is programmed by default as Private Reply.

- 1 To capture the radio ID of the person currently talking to your group after transmission is over, press the **Top** button.

2 To initiate the conversation privately, press the **PTT** button.

9.1.2

Private Reply Status Indicator

Table 14: Private Reply Status Indicator

Private Reply Status	Top Button LED Indicator	Voice Prompt or Tone
Private Reply re-request in queue (initiated using Top button press) – Initiator party	Blink Orange	“Private Reply”
Private conversation initiated (using the PTT button) – Receiver party	Solid Orange	Private TPT

Private Reply Status	Top Button LED Indicator	Voice Prompt or Tone
Private Call notification ⁴ – Receiver party	Solid Orange	“Private”
Private conversation in progress – Both parties	Solid Orange	Private TPT
End of private conversation – Both parties	Off	“Private Over”

⁴ This notification occurs only once in the beginning of the call.

9.2

Direct Call

You can call a pre-determined user programmed in the radio privately. The Direct Call feature is configurable using the Customer Programming Software (CPS).



NOTICE:

To configure Direct Call feature for the first time in your radio, download the Customer Programming Software (CPS) for free at http://www.motorolasolutions.com/map/en_xa/dlr. Read and upload the radio IDs (identified as "privates" in CPS) in CPS. For more information, refer to [Customer Programming Software on page 69](#)

You have the option to program the Direct Call feature into the **Top** button, or assign to any radio channel.

Direct Call Scenario

User A presses the radio **Top** button to talk directly to User B. User A radio plays voice prompt "Private <Name>" as programmed in CPS, and the **Top** button LED indicator starts blinking orange, indicating that User A is in queue waiting to talk privately to User B.

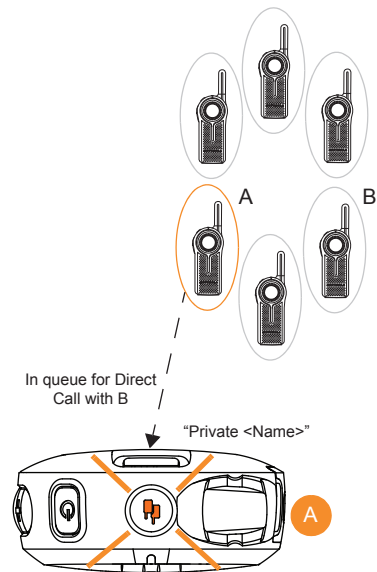

User A presses the **PTT** button to talk privately to User B (who is NOT in a radio conversation), the **Top** button LED indicators of both A & B radios illuminate in solid orange. Radio B plays voice prompt "Private" indicating that the incoming call is a Direct Private Call. Radio plays a distinctive Private TPT.

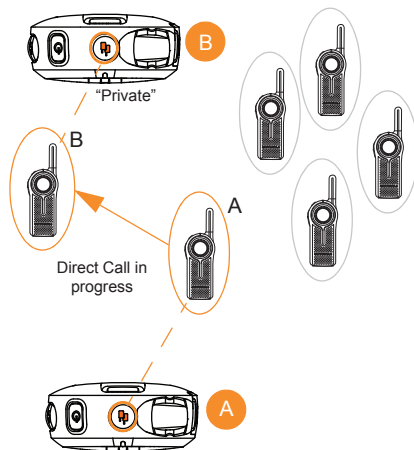

Whenever either user A or B presses the **PTT** button to reply back, they are talking privately to each other. The radio plays a distinctive Private TPT.

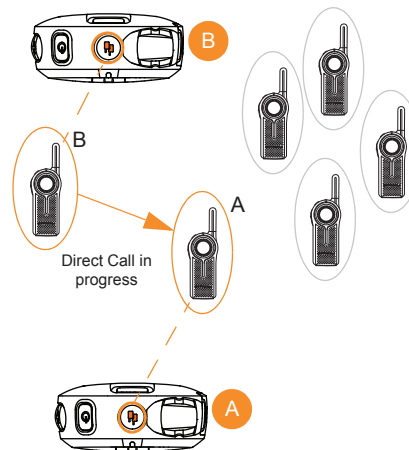

If any of the radio users takes too long to push the **PTT** button and reply back, (the default "Private Hang Time" is 10 seconds), the radio times out and ends the private communication with voice prompt "Private Over" on both radio A and B. The **Top** button LED indicator goes off.

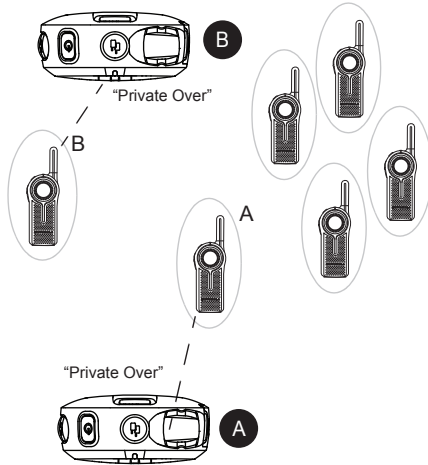

Radio User A (who initiated the Direct Call), ends the call by long pressing the **Top** button. The radio plays voice prompt “Private Over” on both radio A and B to indicate that the private call is over. The **Top** button LED indicator goes off.

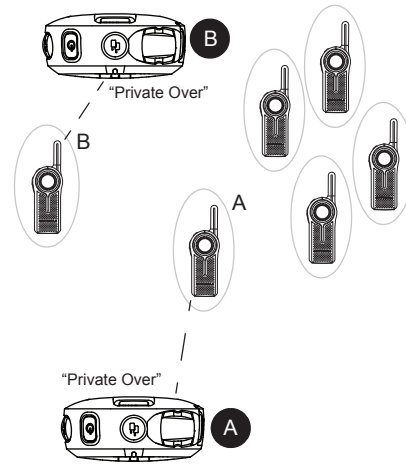

Application Example

Set up your employees to be able to contact directly and privately their supervisor, the Manager on Duty or to reach a designated person for special requests by simply pressing the Direct Call button (**Top** button) and then pushing the **PTT** button to talk.



NOTICE:

If the Direct Call is set up in a specific channel, change to that channel and press the **PTT** button to talk privately.

9.2.1

Direct Call Status Indicator

Table 15: Direct Call Status Indicator

Action	Radio Caller/ Receptient	Top Button LED Indicator	Voice Prompt or Tone
Direct Call initiated using Top button	Caller	Blink Orange	"<Name of Direct Call user>" ⁵
Private conversation initiated using PTT button	Caller	Solid Orange	Private TPT

Action	Radio Caller/ Receptient	Top Button LED Indicator	Voice Prompt or Tone
Private Call notification	Receptient	Solid Orange	"Private"
Private conversation in progress	Caller and Receptient	Solid Orange	Private TPT
End of private conversation	Caller and Receptient	Off	"Private Over"

9.3

Private Reply and Direct Call Frequently Asked Questions

- 1 Question: If I change my mind and want to exit the request for Private Call (or I pressed the **Top** button by mistake), how do I get out of the "private queue" status (Radio **Top** button LED indicator is blinking orange)?

⁵ According to the private user name programmed in CPS.

Answer: Long press the **Top** button. The radio exits the private queue request and the **Top** button LED indicator turns off, returning you to radio normal status.

- 2 Question: What happens if two people (for example user A and C) press their **Top** button at the same time to Private Reply or Direct Call User B?

Answer: Pressing the **Top** button only queues the radio B ID; therefore, there is no issue if two people press the **Top** button at the same time. The issue occurs when these two people press the **PTT** button at the same time to talk privately to B. Then, whoever presses the **PTT** button faster gets to talk privately to B. The other user hears a “busy” or rejection tone.

- 3 Question: What happens if a person Private Reply or Direct Call User B, but User B does not want to engage in the Private conversation?

Answer: The nature of the radio communication is to allow instant communication without the option to decline radio calls. Therefore, if you are concerned about users disrupting group communications or misusing the Private Reply or Direct Call features, make sure that these features are enabled only on authorized radio users.

- 4 Question: I pressed the Private Reply button but nothing happened (for example, **Top** button LED indicator did not start blinking) and instead the radio gives out a busy tone.

Answer: It can be due to different causes such as the **Top** button is disabled or the radio could not store the radio ID you wanted to reply to (this is if the **Top** button was pressed outside the four seconds Group Hang Time).

- 5 Question: What happens if I want to Private Reply to a person that just finished talking?

Answer: The radios allow for “Group Hang Time” (around four seconds) for you to be able to Private Reply to someone who had just finished talking. Push the **Top** button within the hang time window and the radio **Top** button LED indicator starts blinking orange. You can then press the **PTT** button to talk privately.

- 6 Question: How exactly does Private Reply work?

Answer: When you press the radio **Top** button while User B is talking, your radio “captures” the ID of radio B. Once user B finished talking and you press the **PTT** button, your radio calls radio B privately.

- 7 Question: What happens if I want to end the call during a Private Call or Direct Call conversation?

Answer: If you are the user who initiated the Private Reply or Direct Call, you can end the call by long pressing the **Top** button. However, if you are the call receiver, you have to wait for the radio to time out (i.e. no communications detected for more than 10 seconds) OR change the channel.

- 8 Question: I pressed the **Top** button to queue to talk privately to the last person transmitting, but when the user finished talking and I push the **PTT** button to talk, the radio gave me a busy tone or other strange tones and I could not initiate my conversation.

Answer: It is likely there are other users who were waiting as well to talk to the last person transmitting and someone else pressed the **PTT** button before you, giving you a busy or error tone. Another reason is that the last person transmitting has gone out of transmission range.

- 9 If I press the **Top** button (either for Private Reply or Direct Call) and I forgot that I wanted to talk privately and I did not push the **PTT** button:

- Question: Would I be still able hear the group conversations in my channel if I do not press the **PTT** button?

Answer: Yes, you should be able to still hear conversations in your channel.

- Question: How long do I have to talk privately to User B?

Answer: There is no time restriction on how long you can take to press the **PTT** button to talk privately to user A, as long as your **Top** button LED indicator is blinking.

- Question: Does the radio gives me any alert to know that I am in still in the private queue mode?

Answer: Yes. While waiting in queue to talk privately, you will receive a call reminder tone after 1 minute of being in queue, followed by another reminder tone 4 minutes after that. No other reminder is heard afterwards, but you remain in queue until Private Reply mode is exited.

- Question: How do I respond to group conversation if I have already pushed the **Top** Button (for either Private Reply or Direct Call) and my **Top** button LED indicator is blinking?

Answer: Long Press the **Top** button to exit the private queue mode (**Top** Button LED indicator

should turn off) and press the **PTT** button to reply to the group call.

- 10** Question: What happens if I am in queue to talk privately (LED indicator blinking orange), then the person that was transmitting finished talking and I press the **PTT** button to talk but the **Top** button LED indicator does not change to solid orange?

Answer: The radio lets you know you are ready for a private communication by turning the **Top** button LED indicator to solid orange and playing the voice prompt “private” in the beginning. During the private conversation, it also plays a distinctive Talk Permit Tone. All these different prompts from the radio need to happen to ensure there is a private communication established. If you do not have these prompts, it means that you do not have private communication established and you need to try again.

- 11** Question: How do I know when the radio is no longer in Private Mode conversation?

Answer: You are no longer in a private conversation if the **Top** button LED indicator is not illuminating solid orange and is either blinking or switched off instead. Furthermore, the radio plays the voice prompt: “Private Over”.



NOTICE:

Remember that the Private Reply and the Direct Call time out after 10 seconds of inactivity in which both users are sent back to the group call mode (Radio plays the voice prompt “Private Over” and the **Top** button LED indicator goes off).

9.4

Call All Available

You can perform group call to all users available on different channels, and users who are not in an on-going radio conversation. The Call All Available feature does not interrupt ongoing communications.

You have the option to program the Call All Available feature into **Top** button, or assign to a channel using the Customer Programming Software (CPS).

The Call All Available feature allows a communication with all available radio users at once in a temporary “super channel” group, without having to change through each channel individually.

When a caller initiate the Call All Available transmission, the **Top** button is disabled in all radios involved. The

Private Reply feature or Direct Call feature is disabled during this period.

The radio times out a Call All Available communication after four seconds of inactivity. The time out prevents all users from being tied up indefinitely in an unnecessary group conversation.

Call All Available Scenario

All users in Channel 3 and 4 are available (nobody is transmitting).

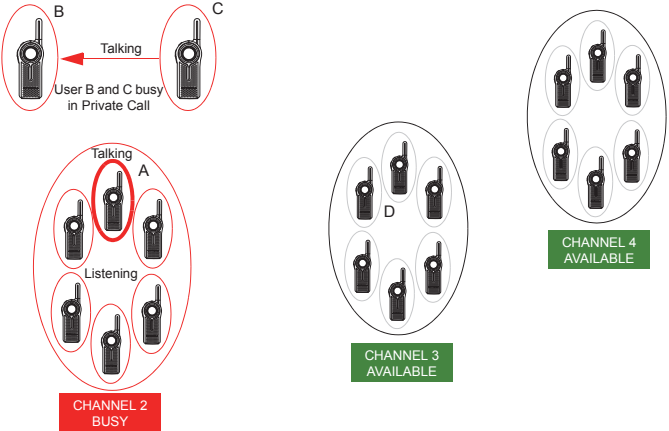

User D in Channel 3 initiates Call All Available by pressing the radio **Top** button⁶

⁶ **Top** button must be pre-programmed to Call All Available before using this feature.

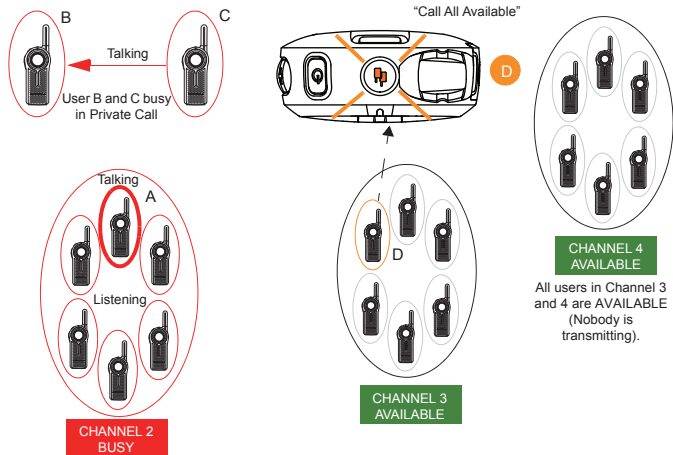

All users from Channel 3 and 4 are brought into a temporary "super channel" group. User D then presses the **PTT** button and start talking to all available users in both channels.

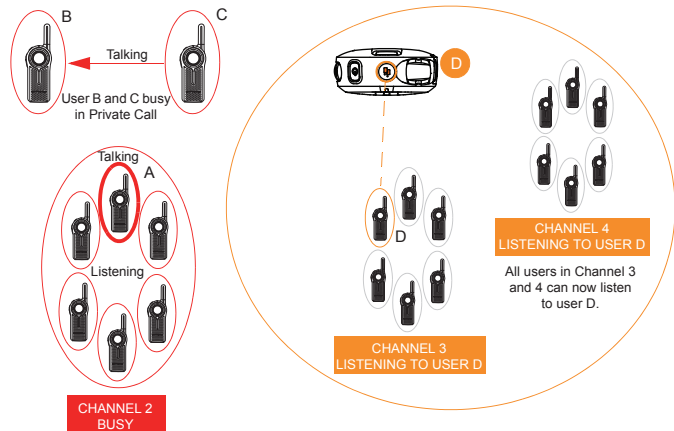

All radios **Top** buttons in Channel 3 and 4 are solid orange indicating that Call All Available is in progress.

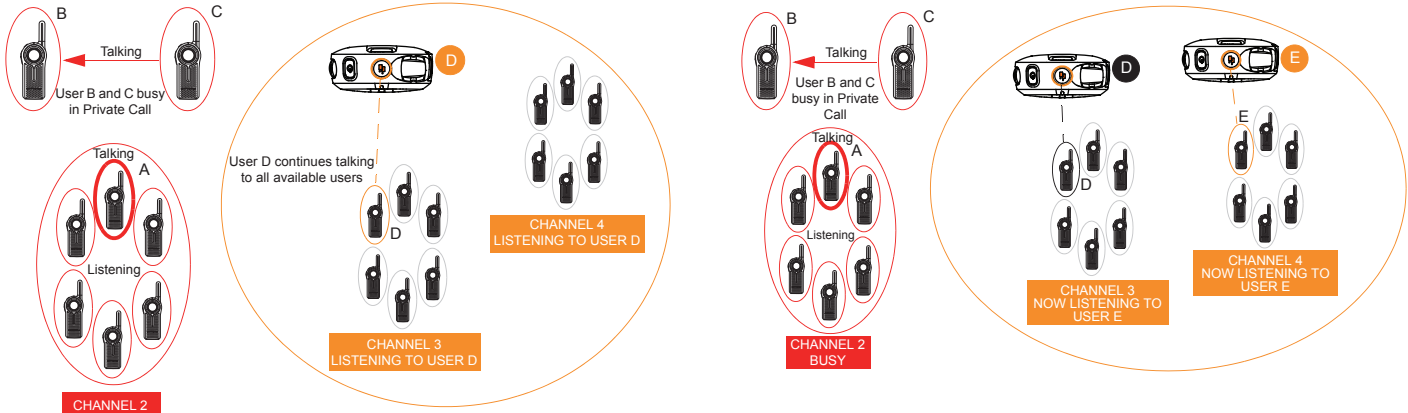

User D finished talking [Top button LED indicator still solid orange⁷]. User E presses the **PTT** button and starts talking to all available users. All users in Channel 3 and 4 now hear User E. All radios **Top** buttons are solid orange indicating that Call All Available is in progress.

Once all users finished communicating (no transmissions for more than four seconds), the radios time out and end the Call All Available “super channel” group. All users in channel 3 and 4 return to their original talk channels.

⁷ Users in the Call All Available group must respond back within the four second hang time or the Call All Available mode will be terminated.

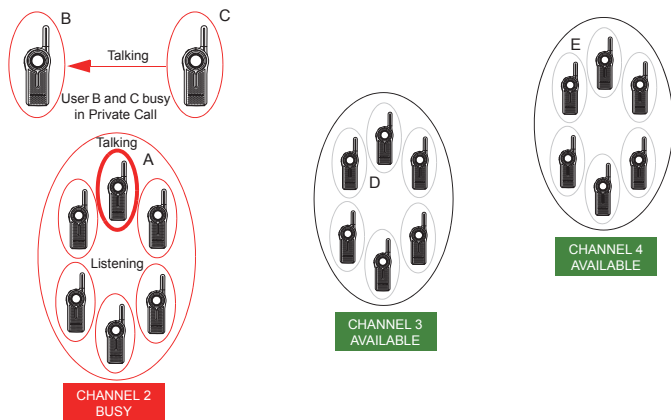

Application Example

An employee in a retail shop uses the radio with the **Top** button programmed to Call All Available. This employee is trying to check if anyone took the back room scanner. The employee presses the **Top** button followed by the **PTT** button and asks "Does anybody know who has the backroom scanner?". Anyone, irrespective of their channel, who is not already part of another conversation, will hear this call and can talk back to the whole group of users (who are tied up in the super channel group call) and provide the needed information.

9.4.1

Call All Available Status Indicator

Table 16: Call All Available Status Indicator

Action	Radio Caller/ Receptient	Top Button LED Indicator	Voice Prompt or Tone
Call All Available initiated using Top button	Caller	Blink Orange	"Call All Available"
Call All Available conversation initiated using PTT button	Caller	Solid Orange	Standard TPT
Call All Available call notification	Receptient	Solid Orange	Standard TPT
Call All Available conversation	Caller and Receptient	Solid Orange	Standard TPT

Action	Radio Caller/ Receptient	Top Button LED In- dicator	Voice Prompt or Tone
sation in progress			
End of Call All Available	Caller and Receptient	Off	None

9.5

Page All Available

You can communicate with all available radio users at once without having to change through each channel individually. The Page All Available feature does not interrupt ongoing communications.

You have the option to program the Page All Available feature into **Top** button, or assign to a channel using the Customer Programming Software (CPS).

The Page All Available feature is a one-way group voice announcement to all users on different channels who are

not in an ongoing radio conversation. It prevents users from getting in an unwanted ongoing group conversation.

Page All Available Scenario

All users in Channel 3 and 4 are available (nobody is transmitting).

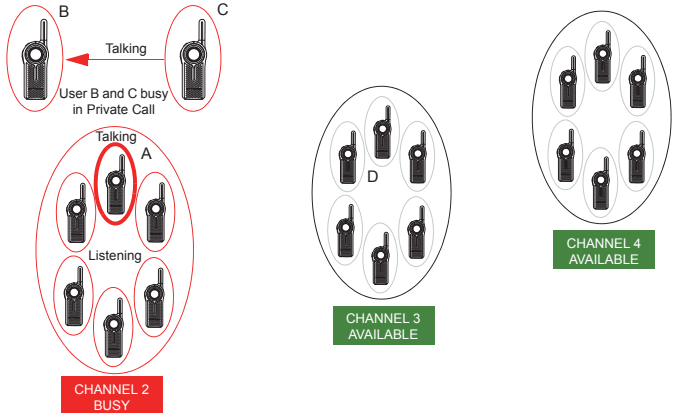

User D in Channel 3 initiates Page All Available by switching to Channel 6⁸.

⁸ Channel 6 must be pre-programmed to Page All Available before using this feature.

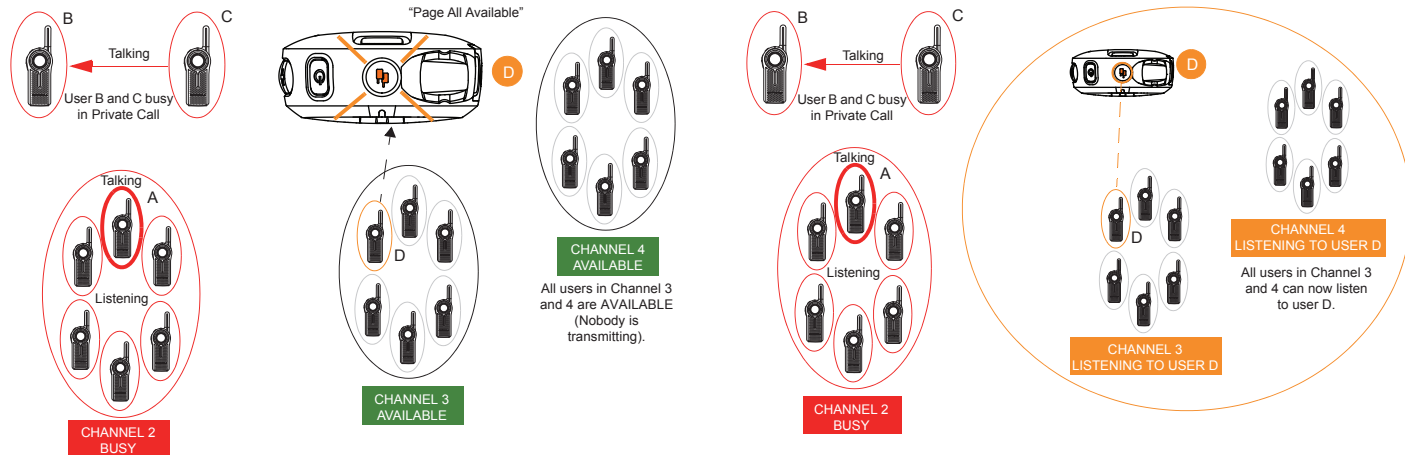

All users from Channel 3 and 4 are brought into a temporary "super group". User D then presses the **PTT** button and starts talking to all available users in both channels.

User D continues talking to all available users. User E wants to reply to user D and presses the **Top** button⁹. User E goes in queue for Private Reply.

⁹ **Top** button of Radio E must be pre-programmed to Private Reply feature.

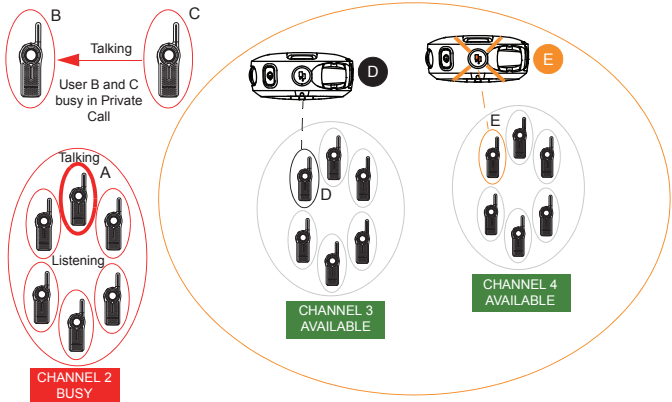
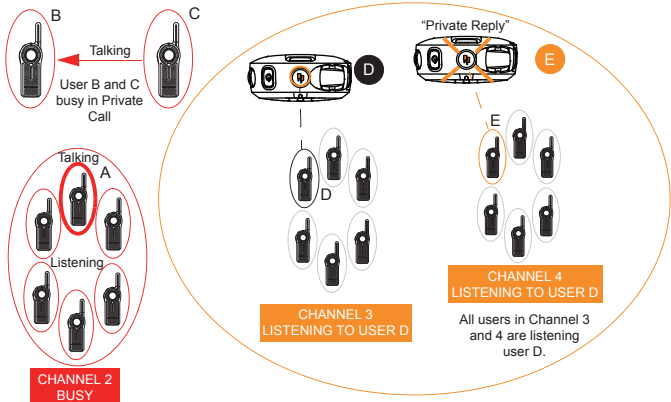

Once user D stops transmitting by releasing the **PTT** button, the Page All Available is over. All users in Channel 3 and 4 are back to their original channel groups. User E remains in queue for Private Reply.

User E presses **PTT** to talk to user D. They are now engaged in a Private Conversation. Nobody else can hear them. The **Top** button LED indicator for radio D and E illuminates solid orange.

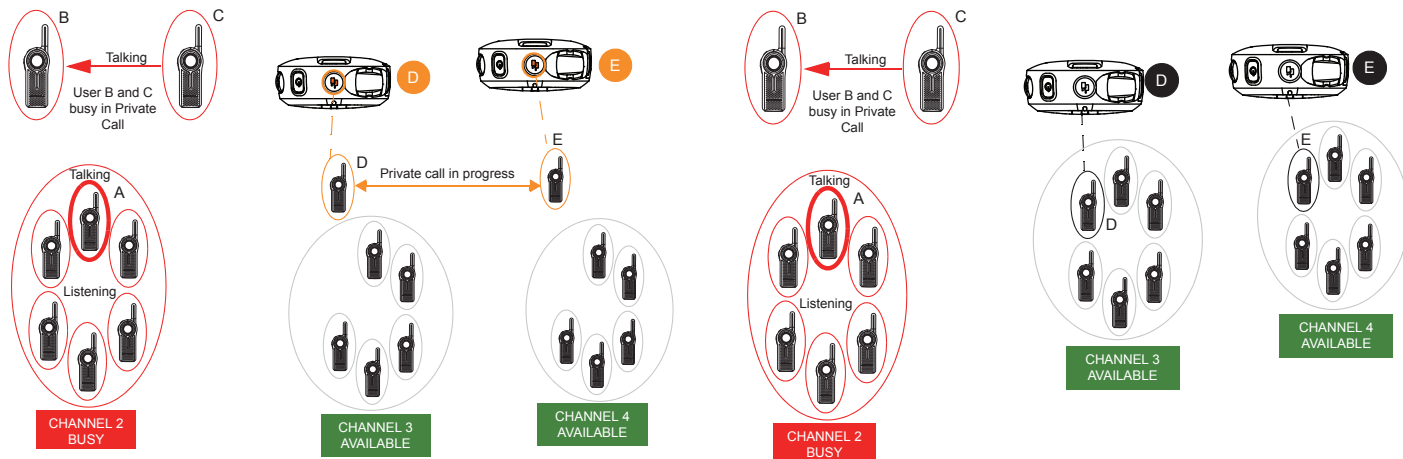

Once User D and E finish the private conversation, they are returned to their respective group channel. The **Top** button LED indicator both radios switched off.

Application Example 1

An employee in a retail shop uses the radio with the **Top** button programmed to Private Reply and Channel 6 programmed to Page All Available feature. This employee is looking for anyone (in any of the group radio channels) who can come over to help out in the back room. The employee changes to the Page All Available channel before pressing the **PTT** button and asks “Can someone come over to the back room to help out?”. Whoever is available in any of the radio channels can privately reply to

the employee to ask for more details or to confirm that they are available to help.

Application Example 2

Anna needs to talk privately to another user (John) and she is not sure in which channel to find him. It is cumbersome to browse all channels to search for John. Anna uses the radio with the **Top** button programmed to Private Reply and Channel 6 programmed to Page All Available feature. She switches to Channel 6 and asks “John Smith, are you available?”

If John is available, he can reply privately (by pressing the **Top** button). If no response is heard, it means that he is busy in another radio call or is not within the communication range.

9.5.1

Page All Available Status Indicator

Table 17: Call All Available Status Indicator

Action	Radio Caller/ Receptient	Top Button LED Indicator	Voice Prompt or Tone
Page All Available initiated using Top button	Caller	Blink Orange	“Page All Available”
Page All Available conversation initiated using the PTT button	Caller	Solid Orange	Standard TPT
Page All Available Call notification	Receptient	Solid Orange	Standard TPT
Page All Available	Caller and Receptient	Solid Orange	Standard TPT

Action	Radio Caller/ Receipient	Top Button LED In- dicator	Voice Prompt or Tone
conversation in progress			
End of Page All Available	Caller and Receipient	Off	None

**NOTICE:**

To initiate Page All Available, press the **Top** button or change to a channel that is preset to Page All Available followed by the **PTT** button to talk to all available users in different channels.

Top button must be pre-programmed to Page All Available via Advanced Configuration or CPS. The only way to respond to someone doing a Page All Available call is by Private Reply. Page All Available can also be programmed to a radio channel.

For more information, refer to [Customer Programming Software on page 69](#).

Customer Programming Software

You can program or change features in your radio by using Customer Programming Software (CPS) and the CPS Programming Cable (Part Number HKKN4027_).

CPS gives you the flexibility to prevent radio features to be accidentally modified by users by providing the option to disable functionalities like Factory Reset, and Advanced Configuration Mode. It provides security by giving the option to set up a password for profile radio management.

You can download the software for free at www.motorolasolutions.com/map/en_xa/dlr

10.1 Setting Radio to Customer Programming Software

Verify that the switch in the Programming Cable is in Digital position. If your Customer Programming Software (CPS) Programming Cable is showing "CPS/Flash," ensure to position it to "Flash".

To program, connect the radio from the Drop-in Charger Tray and CPS Programming Cable to your computer.

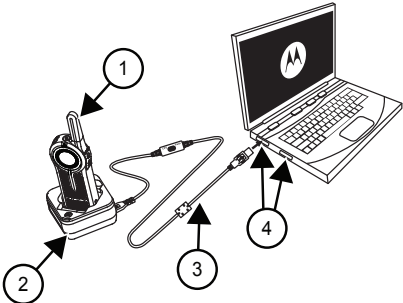

Figure 15: Setting-up the Radio to the CPS

Table 18: Setting-up the Radio to the CPS

Number	Description
1	Radio
2	Single Unit Charger (SUC)
3	CPS Programming Cable

Number	Description
4	Computer Cable Port

10.2

Customer Programming Software Basic Menu Instructions

- 1 Open the Customer Programming Software.
- 2 Click on the **RADIO** top tab.
- 3 Perform one of the following actions:
 - a Click on the **READ** tab to read the radio.¹⁰
 - b If you want to open a new profile or an existing one, from the drop-down menu **Radio Type**, select **DLR**.

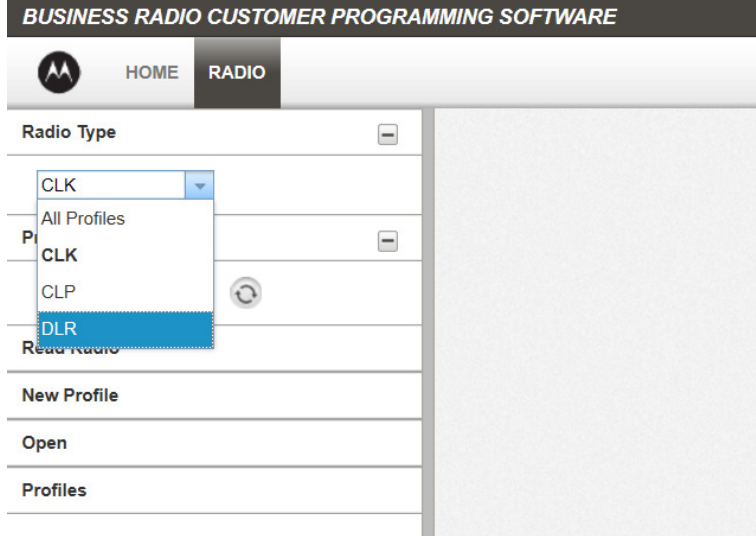

- 4 Perform one of the following actions:

¹⁰ Select the Radio Type to open a new or pre-determined the profile. The CPS is automatically determine the radio model.

a Click Read Radio.

The radio sounds a series of tones to indicate that reading is in progress and uploads your radio profile settings.

b To create customized profile based on the default profile, click New Profile.

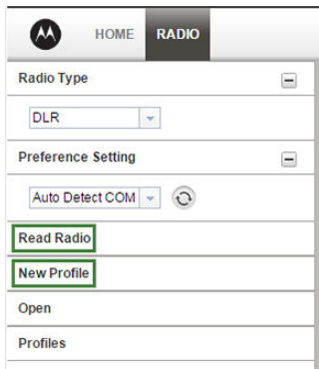

5 Scroll down to see more feature options. Customize as necessary.

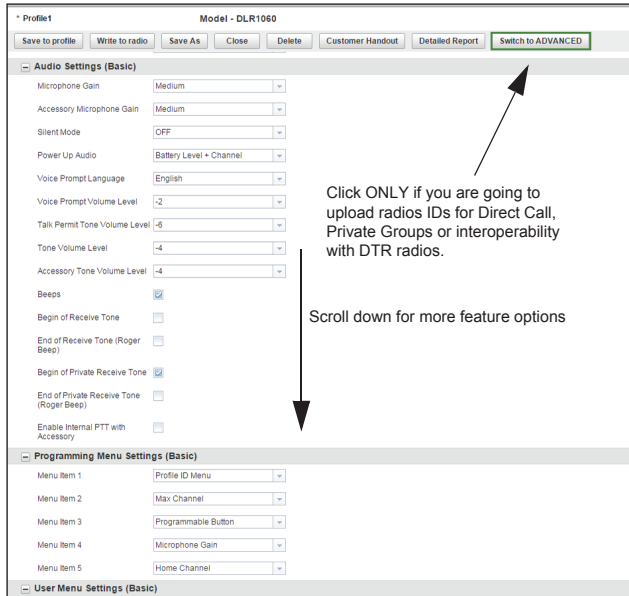

Click ONLY if you are going to upload radios IDs for Direct Call, Private Groups or interoperability with DTR radios.

Scroll down for more feature options

6 Choose which options you want available in the Advanced Configuration Mode. Add any of the features shown to be accessed by the radio **Channel/Menu** button in the Radio Basic Operation mode.

Save to profile Write to radio Save As Close Delete Customer Handout Detailed Report Switch to ADVANCED

Programming Menu Settings (Basic)

Menu Item 1 Profile ID Menu

Menu Item 2 Max Channel

Menu Item 3 Programmable Button

Menu Item 4 Microphone Gain

Menu Item 5 Home Channel

User Menu Settings (Basic)

Menu Item 1 Channel Selection

Menu Item 2 Empty

Menu Item 3 Empty

Menu Item 4 Empty

Buttons (Basic)

Programmable Button Private Reply

Quick Press On/Off Button Mode Battery Status

Direct Call Battery Status

Radio Name Based on Private Name No Operation

Selection of options to be available in the Advanced Configuration mode.

Programmable features to the radio basic menu (Channel / Menu button).

Choose which function to have for ON/OFF button short press.



NOTICE:

You can also choose the function of the **Power** button short press.

- 7 Modify the radio **Top** button feature by changing the default option.

Save to profile Write to radio Save As Close Delete Customer Handout Detailed Report Switch to ADVANCED

Menu Item 1 Channel Selection

Menu Item 2 Battery Status

Menu Item 3 Radio Name

Menu Item 4 Empty

Buttons (Basic)

Programmable Button Private Reply

Quick Press On/Off Button Mode Private Reply

Direct Call Call All Available

Radio Name Based on Private Name Page All Available

Radio Name Mute

Profile ID Number information (Basic)

Profile ID 0000

Programmable features to the radio basic menu (Channel / Menu button).

List of programmable features for the Top Button.

- 8 To enable the Direct Call feature in your Basic Menu options, perform the following actions:

Save to profile Write to radio Save As Close Delete Customer Handout Detailed Report Switch to ADVANCED

Menu Item 1 Channel Selection

Menu Item 2 Battery Status

Menu Item 3 Radio Name

Menu Item 4 Empty

Buttons (Basic)

Programmable Button Private Reply

Quick Press On/Off Button Mode Private Reply

Direct Call Call All Available

Radio Name Based on Private Name Page All Available

Radio Name Mute

Profile ID Number information (Basic)

Profile ID 0000

Direct Call will be listed in this drop down menu of Top Button programmable features once it is enabled.

- a Upload the radio(s) unique private identification (12 digit) number.
- b Click on the **Switch to ADVANCED** button.
- c On **Privates (Advanced)** tab, Click **Add** for CPS to upload the radio ID.
- d Customize the radio ID name under the **Name** column. After a radio ID is uploaded, the CPS enables the Direct Call feature.

- 9 Set PROFILE ID number for any four-digit number different from “0000” to differentiate your radios in a radio fleet.

Radio Name Based on Private Name

Radio Name

Profile ID Number information (Basic)

Profile ID

Channels (Basic)

Home Channel

- 10 Assign the Home Channel by performing the following actions:

- a To assign a specific channel as your Home Channel, select the channel using the drop-down menu under Home Channel. CPS enables the option to choose any channel you want as your designated Home Channel for the radio that you are programming.

Profile ID Number information (Basic)

Profile ID

Channels (Basic) (*)Number of channel shown in the drop down menu varies according to the radio model

Home Channel

Home Channel Mode

	Index	Chan 02		User Customized VP
<input type="checkbox"/>	1	Chan 03	31	
<input type="checkbox"/>	2	Chan 04	32	
<input type="checkbox"/>	3	Chan 05	33	
<input type="checkbox"/>	4	Chan 06	34	
<input type="checkbox"/>	5		35	

Select channel(*) to assign the Home Channel to.



NOTICE:

Home Channel is turned off by default.

- b After setting your Home Channel, select the mode using the drop-down menu under **Home Channel Mode**.

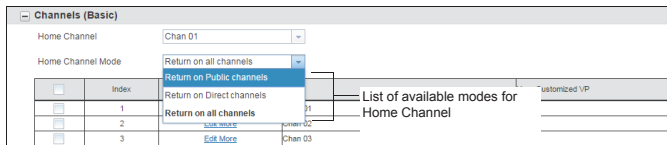

11 Customize the name of your channel (alias) in the **Name** column.

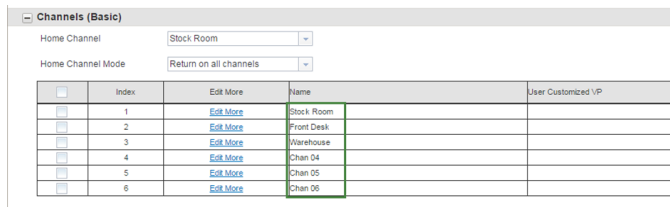

12 Configure a customized Channels Voice Prompt by performing the following steps:

- a Click **Edit More** to edit the voice prompt.

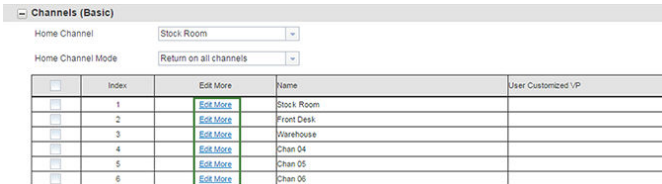

You can set your own customized Channels Voice Prompt (VP) to enable your channel name to be announced by the radio.

- b Select the **Enable User Customized VP** check box to enable the standard Voice Prompt.

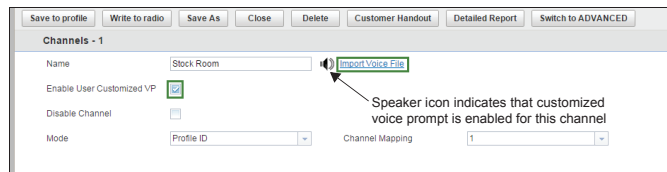

When a speaker icon appears in the menu, then that channel has customized voice prompt enabled.

- c Click the speaker icon to preview the User Customized VP.

d If you want to include your own voice recording, click on **Import Voice File**¹¹.

13 After changing all the settings, program your radio by clicking **Write to radio** button.

CPS displays a window confirming the programming of your radio is successful.



NOTICE:

Save your profile at any time to use the same settings when programming other radios by clicking on **Save to profile** button. This saves the profile to the current default path on your computer. To specify a different path to save the profile, click the **Save As** button.

¹¹ .wav audio files supported.

Cloning Mode

You can clone radio profiles from a Source radio to a Target radio.

Use the following devices/tools to perform Cloning Mode:

- Multi-Unit Charger (MUC) – Optional accessory
- Two Single Unit Chargers (SUC) and a Radio-to-Radio cloning cable - Optional accessory
- Customer Software Programming (CPS) – Free software download
- Wireless PIN cloning

Contact your dealer for more information.

11.1

Configuring Cloning Mode

Press **Power** → **PTT** → **Volume Down** buttons at the same time.

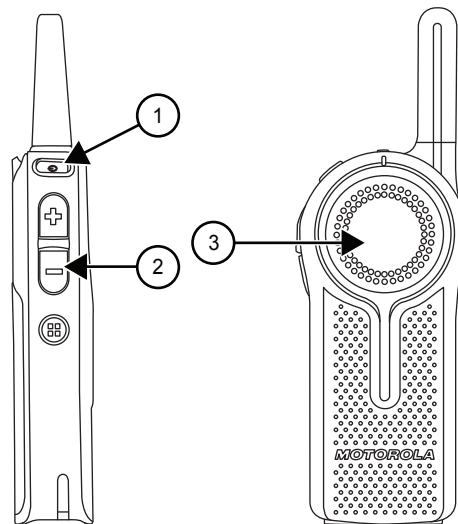

Table 19: Cloning Mode

Number	Description
1	Power button
2	Volume Down button

Number	Description
3	PTT button

You hear Cloning Mode beeps, and "Cloning Mode, Serial" voice prompt from your radio.

- 1 and 2
- 4 and 5
- 7 and 8
- 10 and 11



NOTICE:

Read MUC pocket numbers from left to right with the Motorola Solutions logo facing front.

When pairing the Source and Target radio, use the same band type for successful cloning mode.

When cloning, the MUC does not need to be connected to a power source.

11.2

Cloning Mode in Multi-Unit Charger

You can clone radio profiles in Multi-Unit Charger (MUC).

When in Cloning Mode, you must have at least two radios. Identify the radios as follow:

- A Source Radio which consists of the cloned or copied radio profiles
- A Target radio which consists of the cloned from the source radio

The placement for Source Radio in MUC is in pocket 1, 4, 7, or 10.

The placement for Target Radio in MUC is in pocket 2, 5, 8, or 11.

Match the placement for Source and Target radios in MUC as follows:

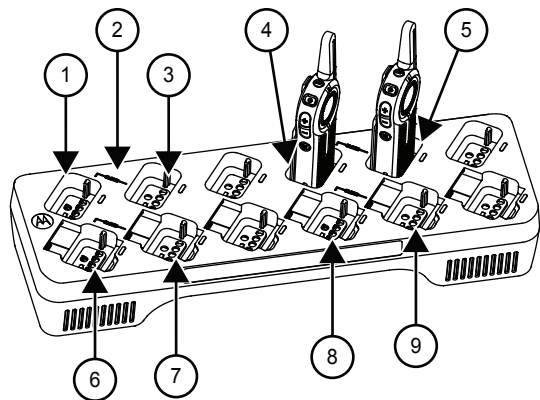

Figure 16: Cloning Mode in Multi-Unit Charger

Table 20: Cloning Mode in Multi-Unit Charger

Number	Item
1	Pocket 1
2	"CLONE" symbol
3	Pocket 2
4	Pocket 4
5	Pocket 5
6	Pocket 7

Number	Item
7	Pocket 8
8	Pocket 10
9	Pocket 11

11.3

Configuring Cloning Mode Using Radio to Radio Cloning Cable

Ensure all radios are fully charged.

Required devices/tools:

- Cloning Cable (Part Number HKKN4028_)
- Two Single-Unit Chargers (SUC)

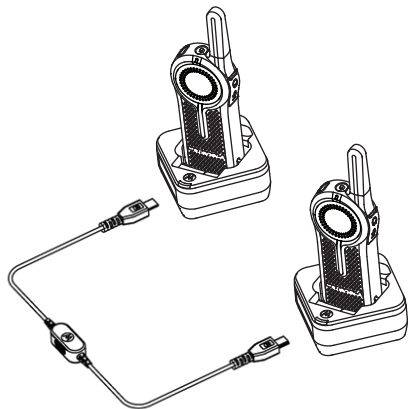

Figure 17: Radio to Radio Cloning

- 1 Turn the radio off.

- 2 Unplug any cables from the SUC.

- 3 Plug one side of the cloning cable mini USB connector to the first SUC, and the other end to the second SUC.



NOTICE:

During the cloning process, no power is being applied to the SUC. The batteries are not charged. Only data communication is being established between the two radios.

- 4 Turn on the Target Radio and place it into one of the SUCs.

- 5 To turn on the Source Radio, press **PTT** → **Volume Down** buttons at the same time for three seconds. You hear Cloning Mode beeps, and "Cloning Mode, Serial" voice prompt from your radio.

- 6 For the Source Radio, power on the radio with the following sequence:
 - 1 Press **PTT** → **Volume Down** buttons at the same time while turning the radio on. Wait three seconds before releasing the buttons, and you hear "Clone Mode Serial" voice prompt from your radio.

- 2 Place the Source Radio in its SUC. Press and release the **Volume Up** button.

You hear "Pass" or "Fail" voice prompt from your Source Radio.

-
- 7 To exit the Clone Mode when the process is completed, press the **Power** button, or long press the **PTT** button.
-

11.4

Troubleshooting Cloning Mode

In the event that cloning fails, perform each of the following steps before attempting to start cloning process again.

- 1 Ensure that the batteries on both radios are fully charged and engaged properly on the radio.
-
- 2 Check the cloning cable connection on both Single Unit Chargers (SUC and if the cable is switched to "Cloning".
-
- 3 Ensure that there is no debris in the charging tray or on the radio contacts and the radio contact is touching the SUC/MUC contact firmly.
-

- 4 Ensure that the Target Radio is turned on.
-
- 5 Ensure that the Source Radio is in cloning mode.
-
- 6 Ensure that the two radios are both from the same frequency band, same region and have the same transmission power.



NOTICE:

This cloning cable is designed to operate only with compatible Motorola Solutions SUC PMLN8034_.

When ordering cloning cable kit, refer to part number HKKN4028_. For more information about the accessories, see [Accessories on page 87](#).

11.5

Cloning Mode Using Wireless PROFILE ID Number

The PROFILE ID Number Wireless Cloning feature is useful when you want to clone the PROFILE ID Number for all the radios in your fleet, but you do not want to clone particular radio settings that may be unique for each radio such as Top button configuration, MIC Gain, Radio Name.

Wireless PROFILE ID preserves each user radio setup, but still ensure that all radios are under the same PROFILE ID Number. This feature is useful if you do not have a programming Cable, Cloning Cable or PC easily available.

11.5.1

Configuring Cloning Mode Using Wireless PROFILE ID Number

- 1 Turn the Source Radio on by performing the following actions:
 - a Press **PTT** → **Volume Down** buttons at the same time while turning the radio on.
 - b Wait three seconds before releasing the buttons until you hear "Clone Mode Serial" voice prompt from the Source Radio.
 - c Press and release the **Volume Down** button.
You hear "Wireless" from the Source Radio.
-
- 2 Turn on the Target Radio by performing the following actions:
 - a Press **PTT** → **Volume Down** buttons at the same time while turning the radio on.

- b Wait three seconds before releasing the buttons until you hear "Clone Mode Serial" voice prompt from the Target Radio.



NOTICE:

Avoid putting powered on radios (more than seven radios) in a container together, other than the Multi-Unit Charger.

-
- 3 To start the wireless PROFILE ID Number cloning on the Source Radio, press and release the **Volume Up** button.
 - You hear a tone.
 - After cloning is completed, you hear "Pass" indicating cloning is successful or "Fail" indicating cloning failed voice prompt from the Source Radio.
 - On the Target radio, the radio receives the PROFILE ID Number information. You hear "Pass" indicating cloning is successful or "Fail" indicating cloning failed voice prompt from the Target Radio.
-

Troubleshooting

Troubleshoot your radio using the method describe in the table.

Table 21: Troubleshooting

If...	Then...	If...	Then...
If there is no power,	recharge or replace the Li-ion battery.  NOTICE: Extreme operating temperature may affect battery life. See Battery Specifications on page 15 .	If the radio generates continuous tone when pressing the PTT button,	<ul style="list-style-type: none"> Verify that the switch on the programming cable is set at Digital position or Flash position in older version programming cable. Ensure that the radio is positioned correctly inside the Single Unit Charger (SUC). press the PTT button again when receive mode ends.
If CPS is unable to read the radio,	perform one of the following actions: <ul style="list-style-type: none"> Ensure that one side of the programming cable is connected to the radio, and the other side of the programming cable is connected to the USB port. 	If the radio does not transmit audio when pressing the PTT button,	perform one of the following actions: <ul style="list-style-type: none"> Verify that nobody else is using the channel and try again. When using an earpiece, ensure that the PTT button is disabled. Ensure to use the earpiece inline with PTT button to transmit.
		If you receive communication	customize your PROFILE ID to a 4-digit number for all radios.

If... **Then...**

that is not within your channel,

If you hear a cracking noise when nobody is talking,

perform one of the following actions:

- While wearing the radio on belts or pockets, check if the **PTT** button is not against another object.
- Use earpiece.

If the audio quality is not good,

perform the following actions:

- 1** Check if the radio settings are the same in all radios.
- 2** Go to **Advanced Configuration Mode**.
- 3** Adjust the microphone sensitivity gain (MIC Gain).

If the audio sounds garbled/robotic,

ensure that you are within transmission range.

If... **Then...**



NOTICE:

Digital technology gives you the advantage to experience clear audio up to the edge of the range. However, when maximum transmission range has been reached, audio may sound garbled just before the transmission is lost completely.

If the transmitted audio is low,

hold the radio vertically 1 inch to 2 inches from your mouth when talking.
For accessory, hold the accessory microphone 2 inches to 3 inches from your mouth when talking.

If there is a loud tone interrupting the conversation,

perform the following actions:

- When talking, ensure not to release the **PTT** button at any moment.

If...	Then...	If...	Then...
	<ul style="list-style-type: none">• Always press the PTT button firmly, until transmission completes.• Ensure not to release the PTT button while transmitting, and not to immediately press the PTT button again.• Ensure the channel is available, and there is a user reachable within the transmission range.		 NOTICE: Radios provide greater coverage in industrial and commercial buildings.
If there is a limited talk range,	perform the following actions: <ul style="list-style-type: none">• Check for clear line of sight to improve transmission. Avoid being near steel and/or concrete structures, heavy foliage, buildings, or vehicles.• Change the placement of the radio. Ensure your radio is not too close to your body, such as in a pocket or on a belt.	If the radio echo feedback,	perform one of the following actions: <ul style="list-style-type: none">• Lower the volume in your radio, and ensure that transmitting and receiving radios are not too close.• Use earpiece.
		If your voice is not transmitted or received,	perform the following actions: <ul style="list-style-type: none">• Ensure that the PTT button is completely pressed when transmitting.• Ensure that the radios have the same settings, and the same PROFILE ID.• Before talking, wait until you hear the Talk Permit Tone. Speaking before hearing the

If...	Then...	If...	Then...
	<p>tone results in the first few words of the transmission being cut out.</p> <ul style="list-style-type: none"> • Recharge, replace, or reposition the batteries. See Battery Specifications on page 15. • Change to a location with no interference. 	<p>If the battery is low,</p>	<p>recharge or replace the battery.</p> <p> NOTICE: Extreme operating temperature may affect battery life. See Battery Specifications on page 15.</p>
<p>If you hear heavy static or interference,</p>	<p>ensure that transmitting and receiving radios are at least five feet apart.</p>	<p>If low battery indicator is blinking although new batteries are inserted,</p>	<p>refer to Attaching the Battery on page 24 and Battery Specifications on page 15.</p>
<p>If the Drop-in Charger LED light does not blink,</p>	<p>perform the following actions:</p> <ol style="list-style-type: none"> 1 Verify that the radio/battery is properly inserted. 2 Check the battery/charger contacts to ensure that they are clean and charging pin is inserted correctly. <p>Refer to Charging with the Drop-In Tray Single Unit Charger on page 17, Radio Status on page 30 and Attaching the Battery on page 24.</p>	<p>If the battery does not charge although it has been placed in the drop-in charger for a while,</p>	<p>perform the following actions:</p> <ul style="list-style-type: none"> • Verify that the drop-in tray charger is properly connected and corresponds with a compatible power supply. See Charging with the Drop-In Tray Single Unit Charger on page 17 and Charging Stand-Alone Battery on page 17.

If...

Then...

- Check the charger LEDs indicators to see if the battery is in error state.
-

Accessories

Choose from a variety of accessories designed, tested, and certified to optimize the performance of this radio.

Table 22: Audio Accessories

Part Number	Description
HKLN4599_	Earpiece with PTT , Microphone, Slim Plug
HKLN4601_	Surveillance Earpiece with PTT , Slim Plug
HKLN4604_	Swivel Earpiece with PTT , Slim Plug
HKLN4606_	Remote Speaker Microphone with PTT , Slim Plug
HKLN4608_	Transparent Acoustic Tube Replacement Part

Table 23: Battery

Part Number	Description
HKNN4013_	Li-Ion Battery 1800 mAh

Table 24: Cables

Part Number	Description
HKKN4027_	Business Radio CPS Cable Kit
HKKN4028_	Business Radio Cloning Cable Kit

Table 25: Chargers

Part Number	Description
PMLN8034_	DLR Single-Unit Charger (SUC) Kit
PMLN8035_	DLR 12-Pocket Multi-Unit Charger (MUC) Kit

Table 26: Carry Accessories

Part Number	Description
HKLN4615_	DLR Swivel Clip Holster Kit

MOTOROLA, MOTO, MOTOROLA SOLUTIONS and the Stylized M Logo are trademarks or registered trademarks of Motorola Trademark Holdings, LLC and are used under license. All other trademarks are the property of their respective owners.
© 2020 Motorola Solutions, Inc. All rights reserved.

