

EVX-S24

Service Manual



MN006597A01-AA

Introduction

This manual provides the technical information necessary for servicing the **EVX-S24** UHF Digital/Analog Transceiver.

Servicing this equipment requires expertise in handling surface-mount chip components. Attempts by non-qualified persons to service this equipment may result in permanent damage not covered by the warranty, and may be illegal in some countries.

Two PCB layout diagrams are provided for each double-sided board in this transceiver. Each side of the board is referred to by the type of the majority of components installed on that side (“Side A” or “Side B”). In most cases one side has only chip components (surface-mount devices), and the other has either a mixture of both chip and leaded components (trimmers, coils, electrolytic capacitors, ICs, etc.), or leaded components only.

As described in the pages to follow, the advanced microprocessor design of the **EVX-S24** Transceiver allows a complete alignment of this transceiver to be performed without opening the case of the radio; all adjustments can be performed from the front panel, using the “Alignment Mode” menu.

While we believe the information in this manual to be correct, Vertex Standard assumes no liability for damage that may occur as a result of typographical or other errors that may be present. Your cooperation in pointing out any inconsistencies in the technical information would be appreciated.

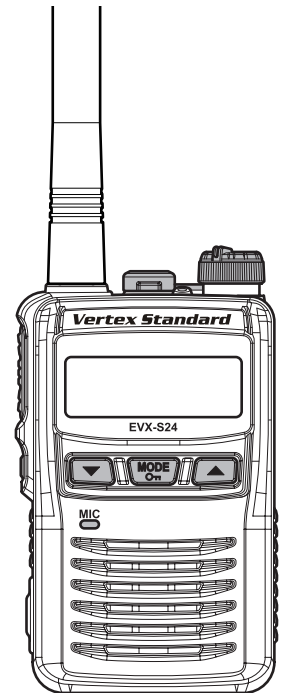

Important Note

This transceiver is assembled using Pb (lead) free solder, based on the RoHS specification.

Only lead-free solder (Alloy Composition: Sn-3.0Ag-0.5Cu) should be used for repairs performed on this apparatus.

The solder stated above utilizes the alloy composition required for compliance with the lead-free specification, and any solder with the above alloy composition may be used.

Contents

Specifications.....	2
Exploded View & Miscellaneous Parts.....	3
Parts List.....	4
Block Diagram.....	5
Circuit Description.....	7
Alignment.....	8
Main Unit (FR028210D) Circuit Diagram.....	17
Display Unit (FR028310A) Circuit Diagram.....	19

Specifications: USA (NA)

General

Frequency range:	403-480 MHz
Channel / Group:	256 Channels / 16 Groups
Emission Type:	7K60F1E / 7K60FXE (Digital: 12.5 kHz Voice) 7K60F1D / 7K60FXD (Digital: 12.5 kHz Data) 7K60F1W (Digital: Combination of 12.5 kHz Voice & Data) 16K0F3E / 11K0F3E (Analog)
Power Supply Voltage:	3.7 V DC (Nominal)
Current Consumption:	1.2 A (Digital, 3 W TX) 1.9 A (Analog, 2 W TX)
Channel Separation:	12.5 kHz (Digital) 12.5 / 20 / 25 kHz (Analog) (USA Model: 12.5 kHz)
IP Rating:	IP67
Operating Temperature Range:	-22 °F to +140 °F (-30 °C to +60 °C)
Charging Temperature Range:	+41 °F to +104 °F (+5 °C to +40 °C)
Frequency Stability:	±1.5 ppm
Antenna Impedance:	50 Ohm (unbalanced)
Dimension (W x H x D):	2.1 x 3.6 x 1.2 inches (55 x 91 x 31.5 mm)
Weight (Approx.):	7.6 oz (215g) (with Battery, Antenna, Belt Clip)

Receiver (Measured by TIA/EIA-603)

Circuit Type:	Direct Conversion
Sensitivity:	0.28 µV (Digital, 1 % BER) 0.25 µV (Analog, 12 dB SINAD)
Adjacent Channel Selectivity:	70 dB (25 kHz) 60 dB (12.5 kHz)
Hum and Noise:	45 dB (25 kHz) 40 dB (12.5 kHz)
Intermodulation:	70 dB
Spurious Image Rejection:	70 dB
Conducted Spurious:	-57 dBm
Audio output:	500 mW @4 Ohm, <10 % THD

Transmitter (Measured by TIA/EIA-603)

Output Power:	3 / 1 / 0.5 W (Digital) 2 / 1 / 0.5 W (Analog)
Modulation:	Sigma Delta Modulation
Maximum Frequency Deviation:	±5.0 kHz (25 kHz Step, Analog) ±2.5 kHz (12.5 kHz Step, Analog)
Conducted Spurious Emissions:	-36 dBm @≤ 1 GHz, -30 dBm @> 1 GHz
FM Hum & Noise:	45 dB (25 kHz) 40 dB (12.5 kHz)
Audio Distortion:	<5% @1 kHz

Specifications subject to change without notice or obligation.

Exploded View & Miscellaneous Parts

FRONT CASE ASSY (COMPONENT)	
PANEL ASSY (FRONT)	
└ SPEAKER	
└ SP NET	
O RING (PANEL)	
KEYPAD	
WINDOW (C146)	
DOUBLE FACE ADHESIVE (WDO)	
MIC MEMBRANE	
PAD (WINDOW)	
PAD (DISP)	
PAD (MIC)	
SPONGE (PANEL) (x 2 pcs) (YEL Model only)	
WIRE ASSY (WHT 25)	
WIRE ASSY (BRN 35)	

REAR CASE ASSY (COMPONENT)	
HOUSING ASSY (REAR)	
└ BEZEL (PTT)	
└ PADDLE (PTT)	
└ BUTTON (PTT)	
└ BUTTON (EMG)	
LID (USB)	
LIGHT GUIDE (TX/RX)	
SHEET (MICROTEX C012)	
SHEET (VENT)	
O RING (SCREW) (2 pcs)	
Y-RECESS TAPTITE-B (2X22SUS B) (x 2 pcs)	
Y-RECESS TAPTITE-B (2X13NI) (x 2 pcs)	
Y-RECESS SCREW (M2X16.5NI) (x 2 pcs)	

CHASSIS ASSY (COMPONENT)	
CHASSIS	
CONNECTOR (SMAJ-VM2)	
O RING (4.8X1.9)	
THERMALCONDUCTIVE PAD (CHG)	
SHEET (6X6) (2 pcs)	

BATTERY COVER ASSY (COMPONENT)	
LID (C146)	
O RING (BATT)	
LATCH (BATT)	
SLIDE KNOB (C146)	
PAD (BATT) (x2 pcs)	
PAN HEAD TAPTITE-B (1.7X4(3) #2)	

MAIN UNIT ASSY (COMPONENT)	
Printed Circuit Board with Components	
GASKET (JACK)	
GASKET (VCO)	
SHIELD SHEET (16X10)	
ELEC. COND TAPE (2.5X2.5)	
RING NUT	
PAN HEAD SCREW (M2X3NI #3)	
PAN HEAD TAPTITE-B (2X5 #2) (4 pcs)	

DISPLAY UNIT ASSY (COMPONENT)	
Printed Circuit Board with Components	
LCD	
MICROPHONE ELEMENT	
HOLDER (LCD)	
LIGHT GUIDE (LCD)	
DOUBLE FACE ADHESIVE (LCD)	
INTER CONNECTOR	
REFLECTOR SHEET	
GASKET	
GROUND PLATE (133)	
SPACER (MIC)	
TAP (LCD) (YEL Model only)	
PAN HEAD TAPTITE-B (1.7X4(3) #3) (4 pcs)	
PAN HEAD TAPTITE-B (2X5 #2) (3 pcs)	

LI-ION BATTERY PACK	VXSTD P/N
FNB-V146LI (3.7V, 2300 mAh)	AAM10X001

AC ADAPTOR (BATTERY CHARGER)	VXSTD P/N
PA-57A (for Japan)	AAL92X001
PA-57B (for USA)	AAL92X002
PA-57C (for EU)	AAL92X003
PA-57U (for UK)	AAL92X004
PA-57F (for Argentina)	AAL92X005
PA-57G (for China)	AAL92X006
PA-57H (for Australia)	AAL92X007
PA-57K (for Brazil)	AAL92X008

Antenna	VXSTD P/N
ATU-6A (400-430 MHz)	AAE23X001
ATU-6B (420-450 MHz)	AAE23X006
ATU-6C (440-470 MHz)	AAE23X002
ATU-6D (450-485 MHz)	AAE23X003
ATU-20AS (400-430 MHz)	AAM23X001
ATU-20DS (440-470 MHz)	AAM23X002
ATU-20FS (450-480 MHz)	AAM23X003

REF.	VXSTD P/N	DESCRIPTION	QTY.
①	U07230302	PAN HEAD SCREW M2X3NI #3	1
②	U9900307	PAN HEAD TAPTITE-B 2X5 #2	7
③	U9900309	Y-RECESS TAPTITE-B 2X22 SUS B	2
④	U9900311	Y-RECESS TAPTITE-B 2X13 NI	2
⑤	U9900313	Y-RECESS SCREW M2X16.5NI	2

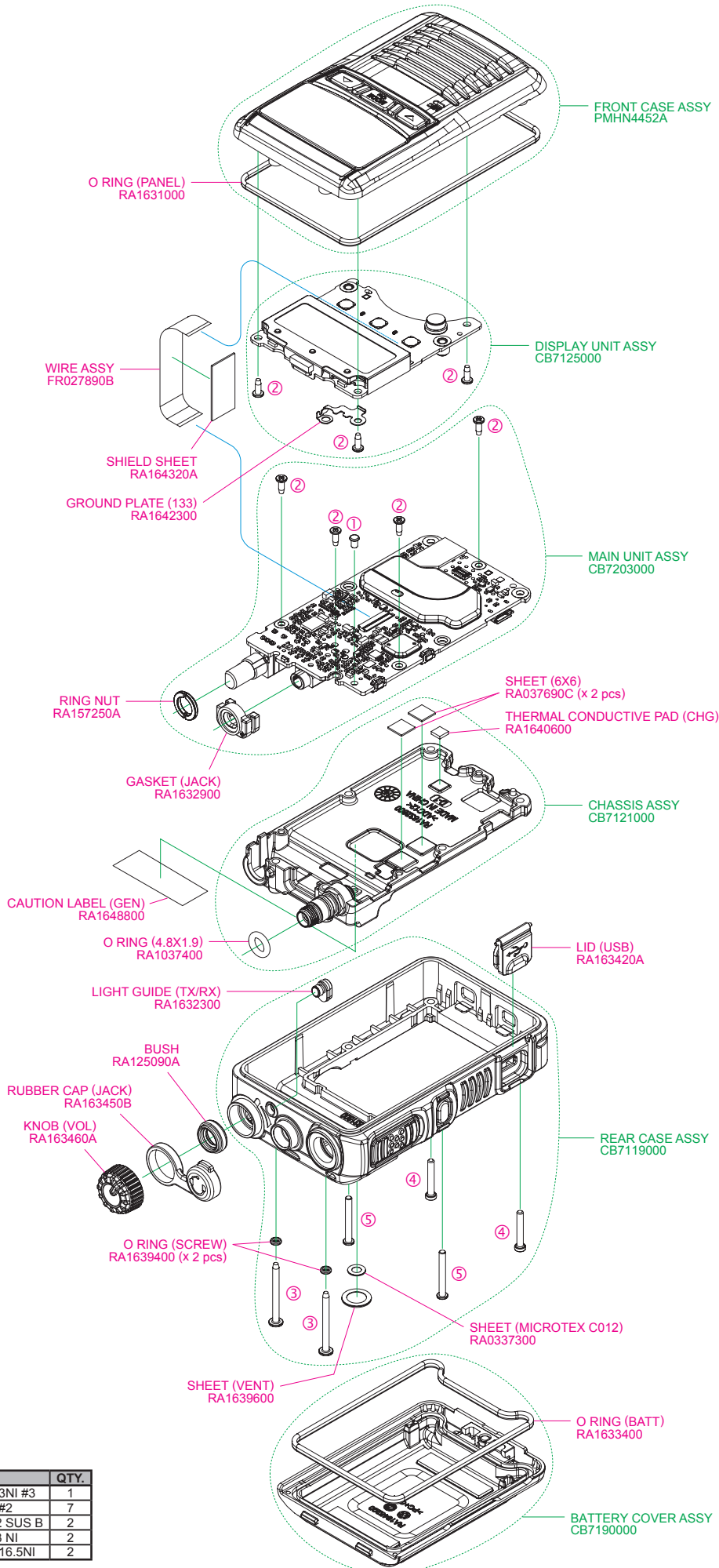

Non-designated parts are available only as part of a designated assembly.

Parts List

REF.	DESCRIPTION	VALUE	MFR's DESIG	VXSTD P/N	SIDE	LAY ADR
FRONT CASE ASSY				CB7188000		
	O RING		(PANEL)	RA1631000		
REAR CASE ASSY				CB7119000		
	LIGHT GUIDE SHEET		(TX/RX)	RA1632300		
	SHEET		(MICROTEX C012)	RA0337300		
	SHEET		(VENT)	RA1639600		
	O RING		(SCREW)	RA1639400		
	Y-RECESS TAPTITE-B	(x2 pcs)	2X22SUS B	U9900309		
	Y-RECESS TAPTITE-B	(x2 pcs)	2X13NI	U9900311		
	Y-RECESS SCREW	(x2 pcs)	M2X16.5NI	U9900313		
BATTERY COVER ASSY				CB7190000		
	O RING		(BATTERY)	RA1633400		
CHASSIS ASSY				CB7121000		
	TERMINAL CONDUCTIVE PAD	(x2 pcs)	(CHG)	RA1640600		
	SHEET		(6X6)	RA037690C		
	O RING		(4.9X1.9)	RA1037400		
MECHANICAL PARTS						
	KNOB		(VOL)	RA163460A		
	LID		(USB)	RA163420A		
	RUBBER CAP		(JACK)	RA163450B		
	BUSH			RA125090A		
	SHIELD SHEET			RA164320A		
ELECTRICAL PARTS						
	WIRE ASSY			FR027890B		
MAIN UNIT ASSY				CB7203000		
F 1001	CHIP FUSE ⚠	3.15A, 36V	FHC16 322ADTP	Q0000118	B	b5
F 1002	CHIP FUSE ⚠	2A, 36V	FCC16 202ADTP	Q0000147	B	a6
F 1003	CHIP FUSE ⚠	2A, 36V	FCC16 202ADTP	Q0000147	B	c5
J 1003	CONNECTOR		ZX62D-B-5PA8(30)	P1091565	B	c5
J 1005	CONNECTOR		03-A70G0-36BKA	P1091581	B	b1
Q 1016	MOSFET		RD04LUS2-501	G3070547	A	A3
S 1001	TACT SWITCH		EVQP42B3M	N5090176	B	c3
S 1002	TACT SWITCH		EVQP42B3M	N5090176	B	c1
TH1001	THERMISTOR		TH05 4B473FR	G9090150	A	A2
VR1001	POT.		TP76N975N13.5FB503RY10034	J60800314	B	a1
X 1001	TCXO	19.2MHZ	NT2520SB 19.2MHZ	H9501523	A	C4
	GASKET		(JACK)	RA1632900		
	RING NUT			RA157250A		
	PAN HEAD SCREW		M2X3NI #3	U07230302		
	PAN HEAD TAPTITE-B	(x4 pcs)	2X5 #2	U9900307		
DISPLAY UNIT ASSY				CB7125000		
DS2001	LCD		GTA4716SY01	G6090231	A	B2
MC2001	MICROPHONE ELEMENT		PFO-T6022P-1.5	M3290060	A	A4
S 2001	TACT SWITCH		SKRMABE010	N5090172	A	A3
S 2002	TACT SWITCH		SKRMABE010	N5090172	A	B3
S 2003	TACT SWITCH		SKRMABE010	N5090172	A	C3
	GROUBD PLATE	(x3 pcs)	(133)	RA1642300		
	PAN HEAD TAPTITE-B		2X5 #2	U9900307		

 When replace a chip fuse, use the part of the same type and value.

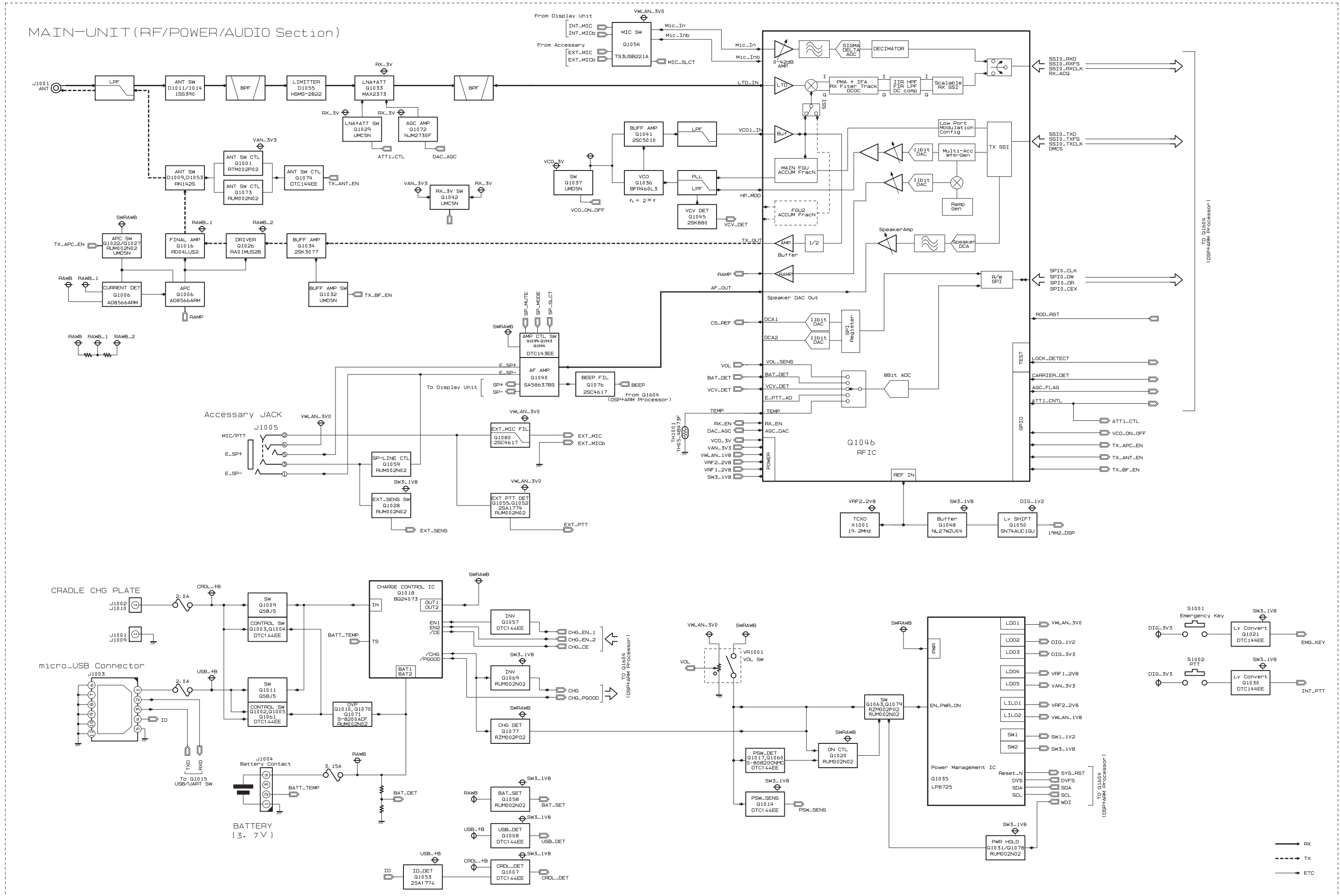

MAIN-UNIT (CPU/DSP Section)

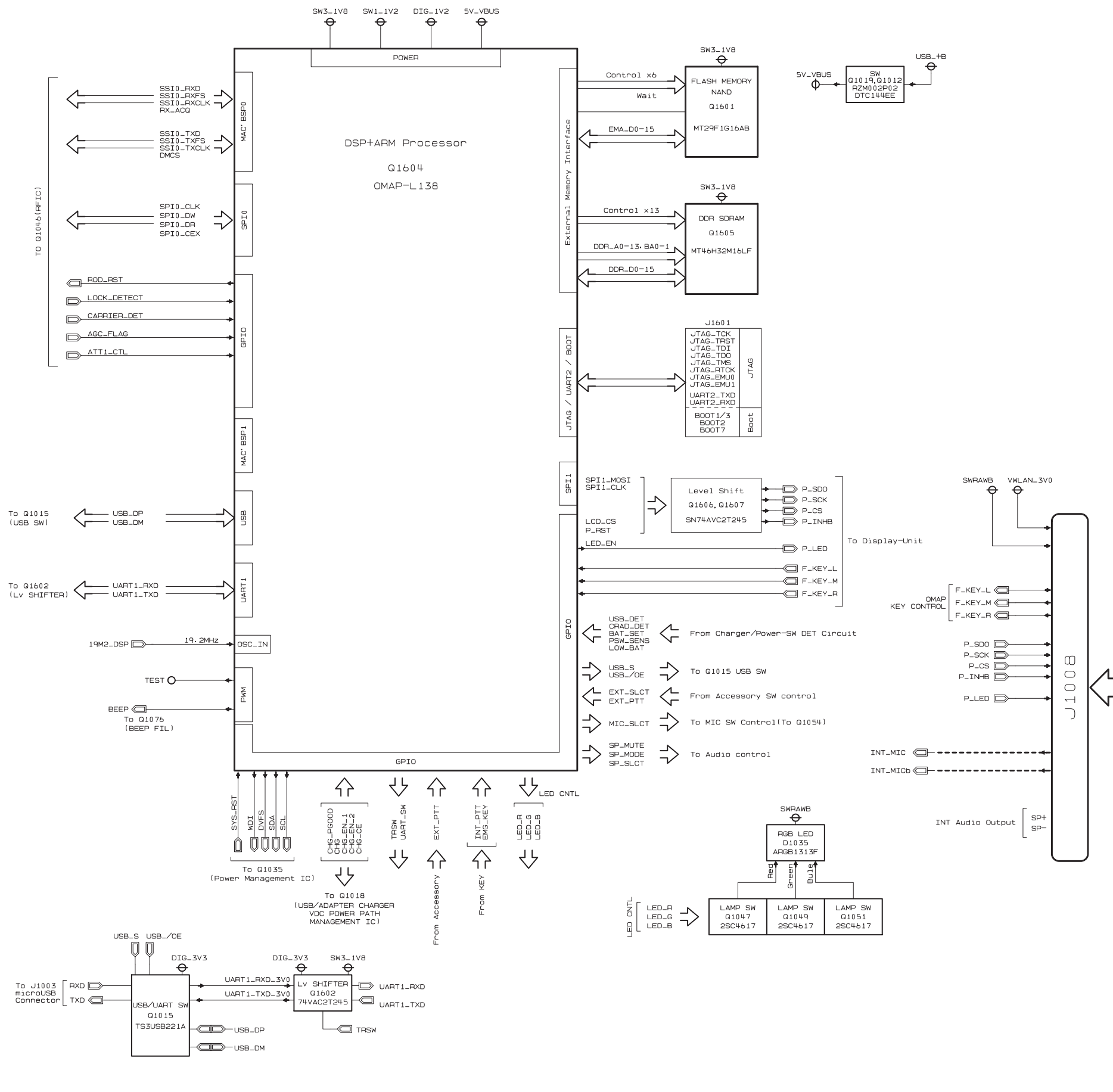

DISPLAY-UNIT

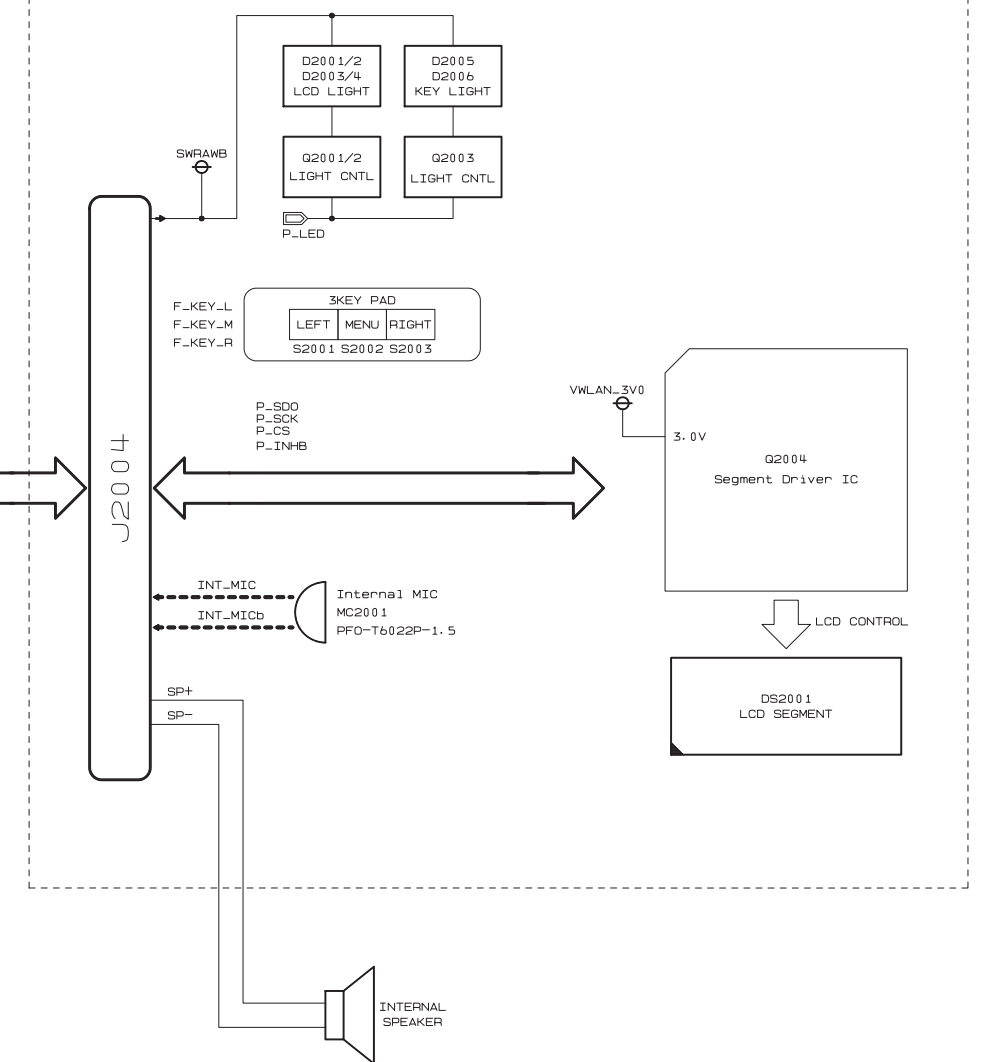

Circuit Description

1. Receiver System

1-1. Front-end RF Amplifier

Incoming RF signal from the antenna passes through the low-pass filter, antenna switching diode **D1011/D1014** (both **1SS390**), and band-pass filter.

The filtered RF signal is applied to the amplifier **Q1033** (**MAX2373ETC+T**), then remove the undesired frequencies by another band-pass filter.

The amplified RF signal is applied to the custom IC **Q1046** (**RODINIA**).

1-2. Demodulator

The custom IC **Q1046** (**RODINIA**) converts a Base Band signal by mixing the RF signal with the local signal, and then the Base Band signal is demodulated by the another section of the custom IC **Q1046** (**RODINIA**).

The local signal is generated by the VCO which consists of **Q1036** (**BFR460L3**) and varactor diodes **D1029/D1030/D1031/D1032** (all **1SV279**).

1-3. Audio Amplifier

The demodulated signal is adjusted the audio volume level in the custom IC **Q1046** (**RODINIA**). The adjusted the audio signal is applied to the audio amplifier **Q1040** (**SA58637BS**). As a result, the audio signal provides up to 500 mW (@4-ohm BTL) for internal speaker and external speaker.

2. Transmitter System

2-1. MIC Amplifier & Modulator

The speech signal from internal microphone **MC2001** on the DISPLAY Unit or external microphone **J1005** on the MAIN Unit is supplied to the custom IC **Q1046** (**RODINIA**), which modulates the speech signal to the FM or digital signal.

2-2. Drive & Final Amplifier Stages

The modulated signal from the custom IC **Q1046** (**RODINIA**) is buffered by **Q1034** (**2SK3077**) and amplified by driver amplifier **Q1026** (**RD01MUS2B**). The low level transmit signal is then applied to **Q1016** (**RD04LUS2**) for final amplification up to 3 watts output power.

The transmit signal then passes through the antenna switch **D1009/D1053** (both **RN142S**) and is low-pass filtered to suppress away harmonic spurious radiation before delivery to the antenna.

2-3. Automatic Transmit Power Control

The current detector **Q1006-1** (**AD8566ARM**) detects the current of the final amplifier **Q1016** (**RD04LUS2**) and the driver amplifier **Q1026** (**RD01MUS2B**), and converts the current difference to the voltage difference.

The output from the current detector **Q1006-1** (**AD8566ARM**) is compared with the reference voltage and amplified by the power control amplifier **Q1006-2** (**AD8566ARM**).

The output from the power control amplifier **Q1006-2** (**AD8566ARM**) controls the gate bias of the driver amplifier **Q1026** (**RD01MUS2B**) and the final amplifier **Q1016** (**RD04LUS2**).

The reference voltage changes into two values (Transmit Power High and Low) controlled by custom IC **Q1046** (**RODINIA**).

3. PLL Frequency Synthesizer

The frequency synthesizer consists of VCO, TCXO **X1001**, and the custom IC **Q1046** (**RODINIA**).

The output frequency from TCXO **X1001** is 19.2 MHz and the tolerance is ± 1.5 ppm in the temperature range -22 °F to $+140$ °F (-30 °C to $+60$ °C).

3-1. VCO (Voltage Controlled Oscillator)

The VCO **Q1036** (**BFR460L3**) generates a between 806-940 MHz. The output from VCO **Q1036** (**BFR460L3**) is amplified by buffer amplifier **Q1041** (**2SC5010**) and then is supplied to the custom IC **Q1046** (**RODINIA**).

The VCO frequency is divided into two by the dividing section of the custom IC **Q1046** (**RODINIA**) in order to become a true receiving or transmitting frequency.

In the reception, the RF signal convert a Base Band signal by mixing with the divided VCO signal, and then supplied to the demodulator section of the custom IC **Q1046** (**RODINIA**), described previously.

In the transmission, the divide VCO frequency is modulated to the FM (or digital) in the custom IC **Q1046** (**RODINIA**), and then is supplied to the transmitter section described previously.

3-2. Varactor Control Voltage

The tuning voltage (VCV) of the VCO establishes the lock range of VCO by controlling the cathode of varactor diode **D1029**, **D1030**, **D1031** and **D1032** (all **1SV279**) from the custom IC **Q1046** (**RODINIA**).

3-3. PLL

The main constitution product of the PLL is equipped all with in the custom IC **Q1046** (**RODINIA**), so that all processing regarding the frequency control is performed in the custom IC **Q1046** (**RODINIA**).

Introduction

The **EVX-S24** is carefully aligned at the factory for the specified performance across the frequency range specified for each version. Realignment should therefore not be necessary except in the event of a component failure, or altering version type. All component replacement and service should be performed only by an authorized Vertex Standard representative, or the warranty policy may be void.

The following procedures cover the sometimes critical and tedious adjustments that are not normally required once the transceiver has left the factory. However, if damage occurs and some parts subsequently are replaced, realignment may be required. If a sudden problem occurs during normal operation, it is likely due to component failure; realignment should not be done until after the faulty component has been replaced.

We recommend that servicing be performed only by authorized Vertex Standard service technicians who are experienced with the circuitry and fully equipped for repair and alignment. Therefore, if a fault is suspected, contact the dealer from whom the transceiver was purchased for instructions regarding repair. Authorized Vertex Standard service technicians realign all circuits and make complete performance checks to ensure compliance with factory specifications after replacing any faulty components.

Those who do undertake any of the following alignments are cautioned to proceed at their own risk. Problems caused by unauthorized attempts at realignment are not covered by the warranty policy. Also, Vertex Standard reserves the right to change circuits and alignment procedures in the interest of improved performance, without notifying owners.

Under no circumstances should any alignment be attempted unless the normal function and operation of the transceiver are clearly understood, the cause of the malfunction has been clearly pinpointed and any faulty components replaced, and realignment determined to be absolutely necessary.

The following test equipment (and thorough familiarity with its correct use) is necessary for complete realignment. Correction of problems caused by misalignment resulting from use of improper test equipment is not covered under the warranty policy. While most steps do not require all of the equipment listed, the interactions of some adjustments may require that more complex adjustments be performed afterwards. Do not attempt to perform only a single step unless it is clearly isolated electrically from all other steps. Have all test equipment ready before beginning, and follow all of the steps in a section in the order presented.

Required Test Equipment

- Frequency Counter with 0.2 ppm accuracy at 600 MHz
- Deviation Meter (linear detector)
- 50 Ohm RF Dummy Load with power rating 10 W at 600 MHz
- UHF Sampling Coupler
- In-line Wattmeter with 5 % accuracy at 600 MHz
- Regulated DC Power Supply (standard 3.7 V DC, 3 A)
- Vertex Standard CN-3 (P/N: A08760001) Antenna Connector
- IBM® PC/compatible Computer with Microsoft® Windows® Vista, 7, 8, 8.1, or Windows 10
- Vertex Standard CE157 PC Programming Software
- Vertex Standard CB000262A01 Micro USB Programming Cable.

Alignment Preparation & Precautions

A 50-Ohm RF Dummy Load and in-line wattmeter must be connected to the main antenna jack in all procedures that call for transmission, except where specified otherwise. Correct alignment is not possible with an antenna.

Because of the BTL (Bridged Trans Less) Amplifier circuit used in the **EVX-S24**, do not connect earth side of the speaker leads to chassis “ground”.

After completing one step, read the following step to determine whether the same test equipment will be required. If not, remove the test equipment (except dummy load and wattmeter, if connected) before proceeding.

Correct alignment requires that the ambient temperature be the same as that of the transceiver and test equipment, and that this temperature be held constant between 68 and 86 °F (20 ~ 30 °C). When the transceiver is brought into the shop from hot or cold air, it should be allowed time to come to room temperature before alignment.

Whenever possible, alignments should be made with oscillator shields and circuit boards firmly affixed in place. Also, the test equipment must be thoroughly warmed up before beginning.

Note: Signal levels in dB referred to in the alignment procedure are based on 0 dB μ EMF = 1 μ V.

Test Setup

Setup the test equipment as shown below for transceiver alignment, then apply 3.7 V DC power to the transceiver.

The Alignment Tool Outline

Installation of the alignment tool

- ❑ Install the CE157 (PC Programming Software) to your PC and execute the CE157.
- ❑ Click the “Alignment” in the “Radio” menu tab of CE157 to open the “Alignment” window.

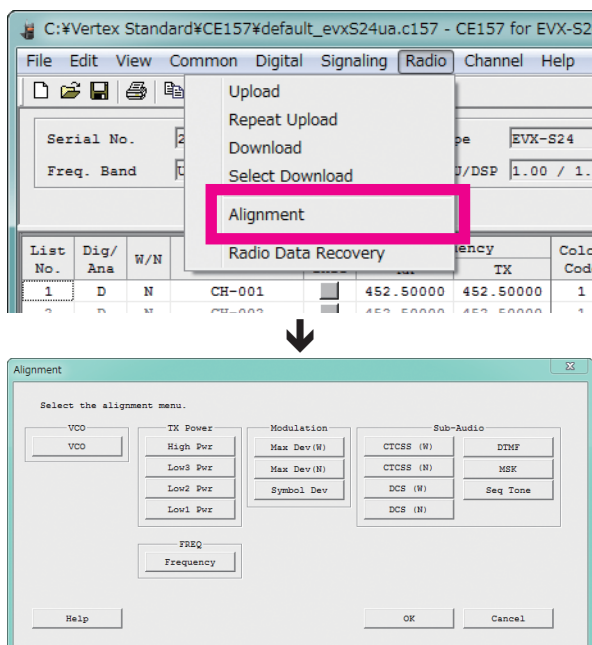

Alignment Mode

In the “Alignment Mode”, the aligned data written in the radio will be able to re-align its alignment data. The value of each parameter can be changed to desired position by “←”/“→” arrow key for data up/down, “↑”/“↓” arrow key for channel up/down, direct number input, and drag the mouse.

Note: when all items are aligned, it is strongly recommended to align according to following order. The detail information is written in the help document of CE156 PC Programming Software.

1. VCO (Confirmation Only)
2. PLL Reference Frequency
3. TX Power <High/Low3/Low2/Low1>
4. Maximum Deviation <Wide/Narrow>

Adjust the following items when needed.

- Symbol Deviation
- CTCSS Deviation <Wide/Narrow>
- DCS Deviation <Wide/Narrow>
- DTMF Deviation
- MSK Deviation
- Sequential Tone Deviation

Action of the switches

When the transceiver is in the “Alignment mode,” the action of the PTT and all Programmable keys are ignored. All of the action is controlled by the PC.

Caution

Please never turn off the power supply during alignment. If the power supply is turned off during alignment, the alignment data will be corrupted.

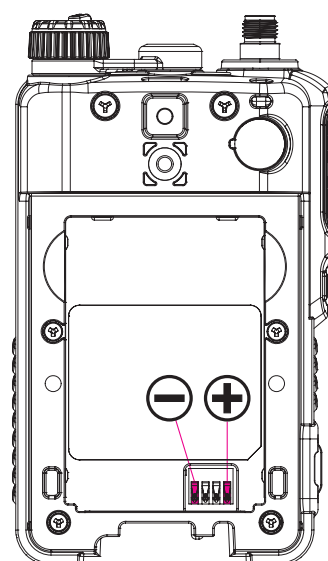
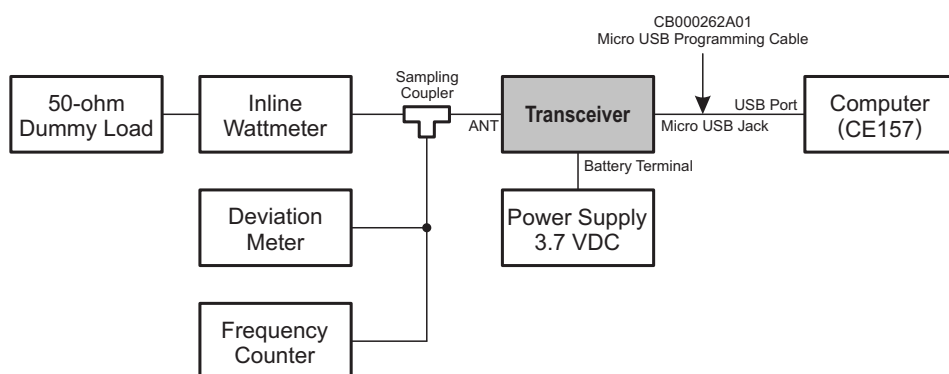

1. VCO (VCO) - This parameter is for confirmation only and cannot align -

This parameter is to confirm whether the VCO status shall be “Lock” or “Unlock”.

1. Click the “VCO” button to open the “VCO” window.
2. Click the “CH” button on the desired channel. The RX VCO status (“Lock” or “Unlock”) will appear in the “RX” box.
3. Click the “PTT” button. The radio starts to transmit on the selected channel, and the TX VCO status (“Lock” or “Unlock”) will appear in the “TX” box.
4. Click the “PTT” button again to stop transmitting.
5. Click the “OK” button to finish the confirmation of the VCO status.

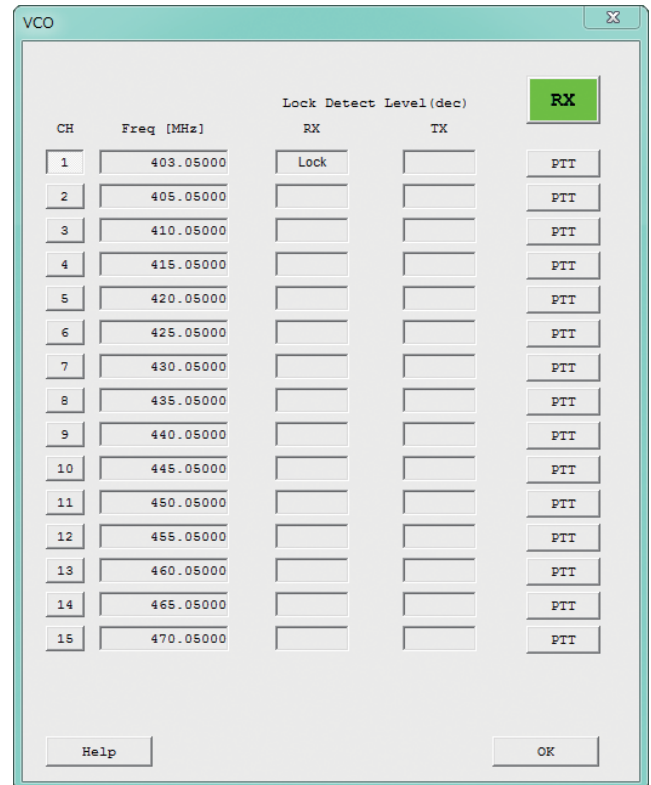
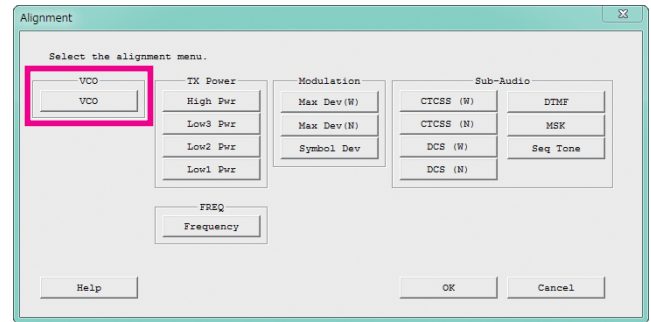

2. PLL REFERENCE FREQUENCY (FREQUENCY)

This parameter is to align the reference frequency for PLL.

1. Click the “Frequency” button to open the “Frequency Alignment” window.
2. Click the “PTT” button or press the “SPACE” bar of the computer’s keyboard, the radio will start to transmit on the center frequency channel.
3. Set the value to get the desired frequency according to the following ways:
 - Dragging the slide bar
 - Clicking the arrow (◀▶) buttons
 - Pressing the left/right arrow key of the computer’s keyboard
 - Entering the value (“0000” - “FFFF”) in the “Current Data” box from the computer’s keyboard
4. After getting the desired frequency, click the “PTT” button or press the “SPACE” bar to stop transmitting.
5. Click the “OK” button to finish the frequency alignment and save the data.

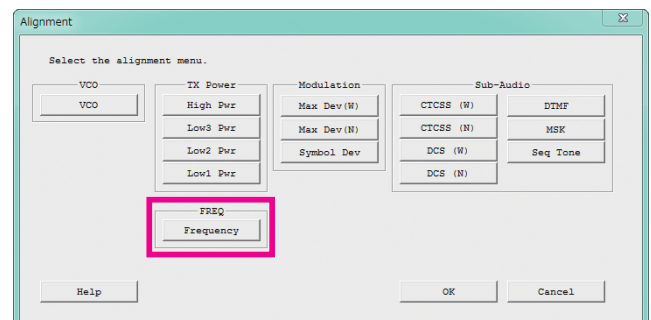

3. TX POWER

This parameter is to align the “High Power,” “Low3 Power,” “Low2 Power” and “Low1 Power” for the selected channel.

1. Click the “TX Power (High Pwr / Low3 Pwr / Low2 Pwr / Low1 Pwr)” button to open the “TX Power Alignment” window.
2. Click the “PTT” button on the desired channel. The radio starts to transmit on the selected channel.
3. Set the value to get desired output power (High Pwr: 3 W, Low3 Pwr: 2 W, Low2 Pwr: 1 W, Low1 Pwr: 0.5 W) on the Power Meter according to the following ways:
 - Dragging the slide bar
 - Clicking the arrow (◀/▶) buttons
 - Pressing the left/right arrow key of the computer’s keyboard
 - Entering the value (“000” - “3FF”) in the “Current Data” box from the computer’s keyboard
4. After getting the desired output power, click the “PTT” button or press the “SPACE” bar to stop transmitting.
5. Click the “OK” button to finish the TX Power alignment and save the data.

You may select the adjusting type from the “Radio” button (ADJ Type) located at the bottom of the screen, as needed.

Basic: “Low-edge / band center / high-edge” and select the channel for alignment (Default).

Single: Alignment value changes only on the selected channel.

All Freq: Alignment value changes on all channels.

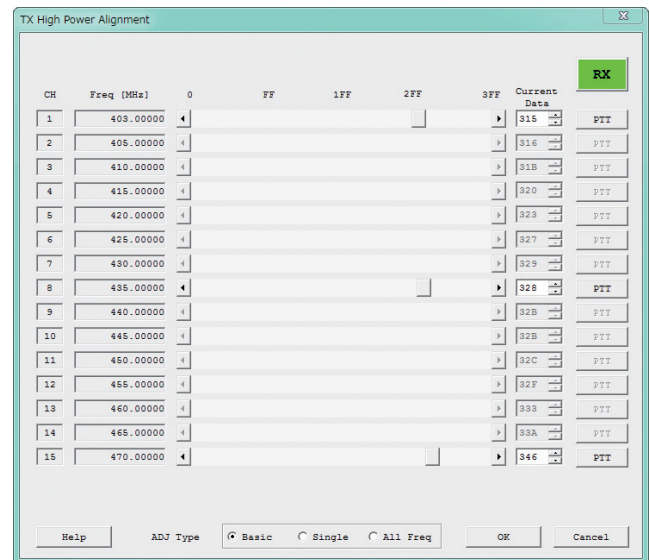
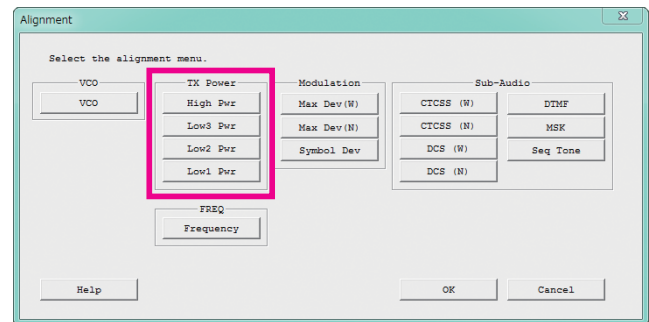

4. MAXIMUM DEVIATION <WIDE> / <NARROW>

This parameter is to align the “Maximum Deviation” (Wide/Narrow).

1. Press the “Max Dev (W/N)” button to open the “Max Deviation Alignment” window.
 2. Click the “PTT” button on the desired channel. The radio starts to transmit on the selected channel.
 3. Set the value to get desired deviation (Wide: 4.2 kHz, Narrow: 2.1 kHz) on the deviation meter according to the following ways:
 - Dragging the slide bar
 - Clicking the arrow (◀▶) buttons
 - Pressing the up-down key of the computer’s keyboard
 - Entering the value (“0000” - “FFFF”) in the entry box from the computer’s keyboard
 4. After getting the desired deviation, click the “PTT” button or press the “SPACE” bar to stop transmitting.
 5. Click the “OK” button to finish the Max Deviation alignment and save the data.
- 1) You may align the deviation level by any modulation frequency (default: 1000 Hz) by changing the value of the “Freq” box located at the bottom left of the screen, if needed.
 - 2) You may select the alignment type from the “Radio” button (**ADJ Type**) located at the bottom of the screen, as needed.

Basic: “Low-edge / band center / high-edge” and select the channel for alignment (Default).

Single: Alignment value changes only on the selected channel.

All Freq: Alignment value changes on all channels.

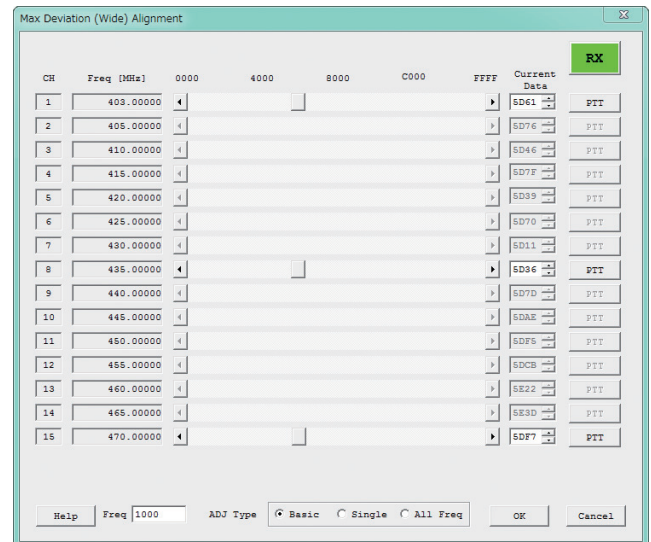
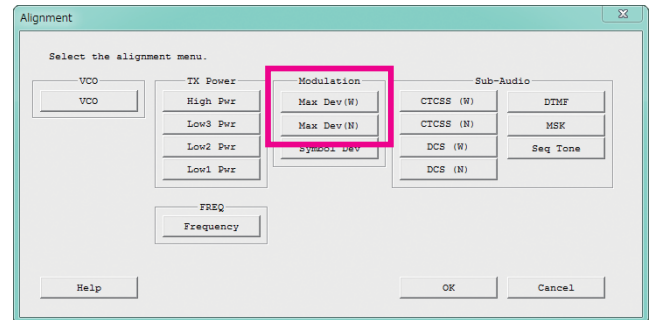

Perform the following alignments as needed.

SYMBOL DEVIATION

This parameter is to align the deviation of the digital mode artificially.

1. Press the “Symbol Dev” button to open the “Symbol Deviation Alignment” window.
2. Click the “PTT” button on the desired channel. The radio starts to transmit on the selected channel.
3. Set the value to get Target Deviation (which is indicated on the screen) on the deviation meter according to the following ways:
 - Dragging the slide bar
 - Clicking the arrow (◀/▶) buttons
 - Pressing the up-down key of the computer’s keyboard
 - Entering the value (“0000” - “FFFF”) in the entry box from the computer’s keyboard
4. After getting the desired deviation, click the “PTT” button or press the “SPACE” bar to stop transmitting.
5. Click the “OK” button to finish the Symbol Deviation alignment and save the data.

You may select the alignment type from the “Radio” button (**ADJ Type**) located at the bottom of the screen, as needed.

Basic: “Low-edge / band center / high-edge” and select the channel for alignment (Default).

Single: Alignment value changes only on the selected channel.

All Freq: Alignment value changes on all channels.

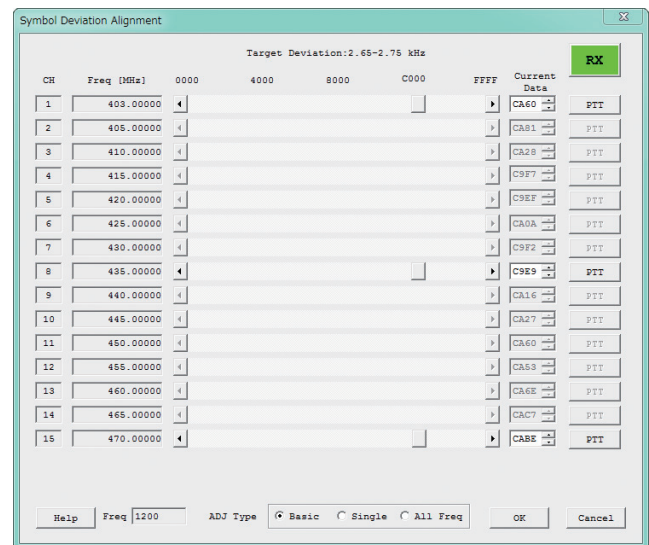
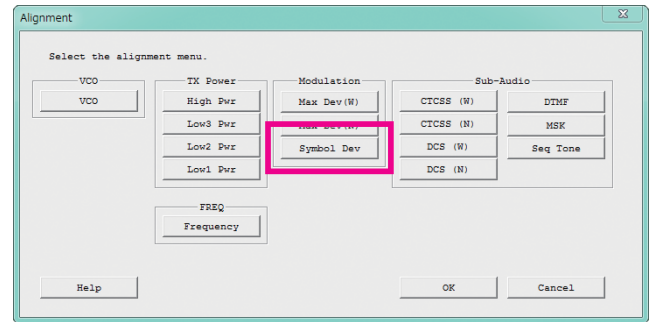

CTCSS DEVIATION <WIDE> / <NARROW>

This parameter is to align CTCSS Deviation of the selected channel.

1. Press the “CTCSS (W/N)” button to open the “CTCSS Deviation Alignment” window.
2. Click the “PTT” button or press the “SPACE” bar of the computer’s keyboard to transmit the radio.
3. Set the value to get desired deviation (Nominal: Wide: 0.55 kHz, Narrow: 0.35 kHz) on the deviation meter according to the following ways:
 - Dragging the slide bar
 - Clicking the arrow (◀/▶) buttons
 - Pressing the left/right arrow key of the computer’s keyboard
 - Entering the value (“-20.00” - “20.00”) in the “Current Data” box from the computer’s keyboard
4. After getting the desired deviation, click the “PTT” button or press the “SPACE” bar to stop transmitting.
5. Click the “OK” button to finish the CTCSS Deviation alignment and save the data.

You may align the deviation level by any CTCSS tone frequency (default: 300.0 Hz) by changing the value of the “CTCSS Freq” box located at the bottom of the screen, if needed.

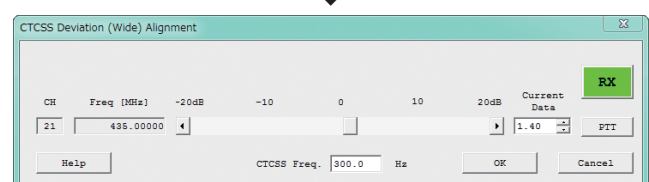
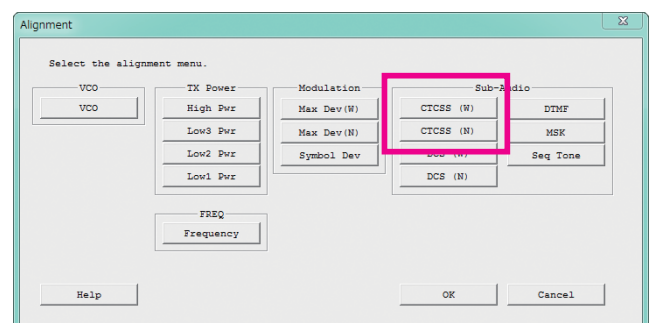

DCS DEVIATION <WIDE> / <NARROW>

This parameter is to align “DCS Deviation” of the selected channel.

1. Press the “DCS (W/N)” button to open the “DCS Deviation Alignment” window.
2. Click the “PTT” button or press the “SPACE” bar of the computer’s keyboard to transmit the radio.
3. Set the value to get desired deviation (Nominal: Wide: 0.6 kHz, Narrow: 0.4 kHz) on the deviation meter according to the following ways:
 - Dragging the slide bar
 - Clicking the arrow (◀▶) buttons
 - Pressing the left/right arrow key of the computer’s keyboard
 - Entering the value (“-20.00” - “20.00”) in the “Current Data” box from the computer’s keyboard
4. After getting the desired deviation, click the “PTT” button or press the “SPACE” bar to stop transmitting.
5. Click the “OK” button to finish the DCS Deviation alignment and save the data.

You may align the deviation level by any DCS code (default: 532) by changing the value of the “DCS Code” box located at the bottom of the screen, if needed.

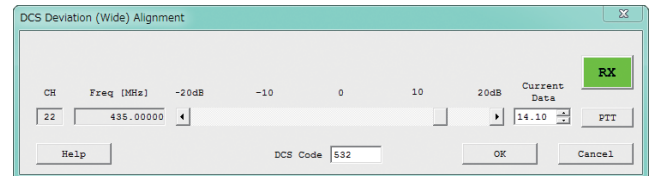
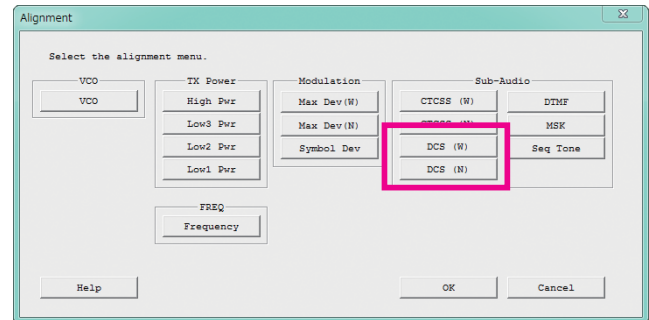

DTMF DEVIATION

This parameter is to align “DTMF Deviation”.

1. Press the “DTMF” button to open the “DTMF Deviation Alignment” window.
2. Click the “PTT” button or press the “SPACE” bar of the computer’s keyboard to transmit the radio.
3. Set the value to get desired deviation (Nominal: 3.0 kHz) on the deviation meter according to the following ways:
 - Dragging the slide bar
 - Clicking the arrow (◀▶) buttons
 - Pressing the left/right arrow key of the computer’s keyboard
 - Entering the value (“-20.00” - “20.00”) in the “Current Data” box from the computer’s keyboard
4. After getting the desired deviation, click the “PTT” button or press the “SPACE” bar to stop transmitting.
5. Click the “OK” button to finish the DTMF Deviation alignment and save the data.

You may align the deviation level by any DTMF tone (default: “0”, available selection: “0” - “9”, “A” - “D”, “E(*)”, and “F(#)”) by changing the value of the “DTMF Code” box located at the bottom of the screen, if needed.

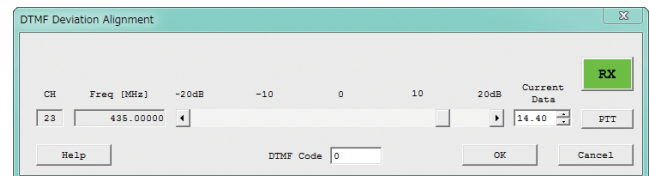
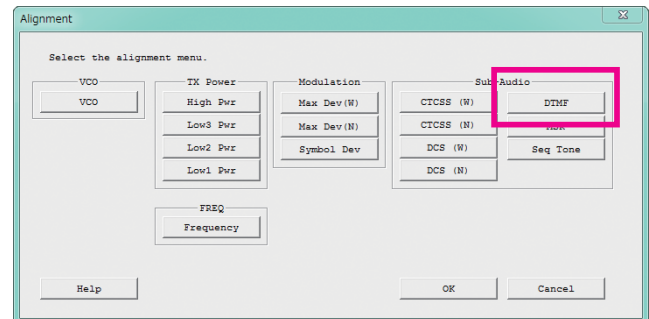

MSK DEVIATION

This parameter is to align “MSK Deviation” which use for the ANI operation of the MDC1200 System.

1. Press the “MSK” button to open the “MSK Deviation Alignment” window.
2. Click the “PTT” button or press the “SPACE” bar of the computer’s keyboard to transmit the radio.
3. Set the value to get desired deviation (Nominal: 3.0 kHz) on the deviation meter according to the following ways:
 - Dragging the slide bar
 - Clicking the arrow (◀/▶) buttons
 - Pressing the left/right arrow key of the computer’s keyboard
 - Entering the value (“-20.00” - “20.00”) in the “Current Data” box from the computer’s keyboard
4. After getting the desired deviation, click the “PTT” button or press the “SPACE” bar to stop transmitting.
5. Click the “OK” button to finish the MSK Deviation alignment and save the data.

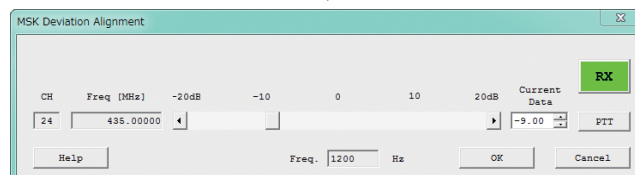
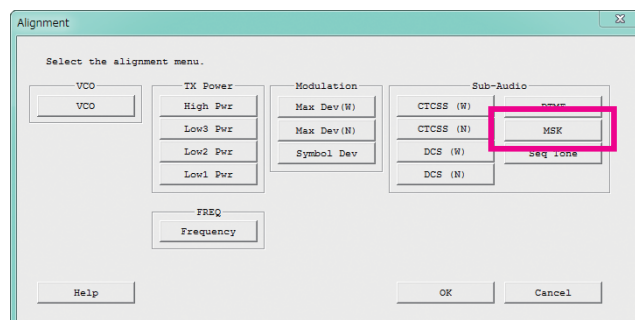

SEQUENTIAL TONE DEVIATION

This parameter is to fine-tune of the “Sequential Tone Deviation” for the 2-Tone and 5-Tone Encoder.

1. Press the “Seq Tone” button to open the “Sequential Tone Deviation Alignment” window.
2. Entering the desired value in the “New” box from the computer’s keyboard.
3. Click the “OK” button to finish the Sequential Tone Deviation alignment and save the data.

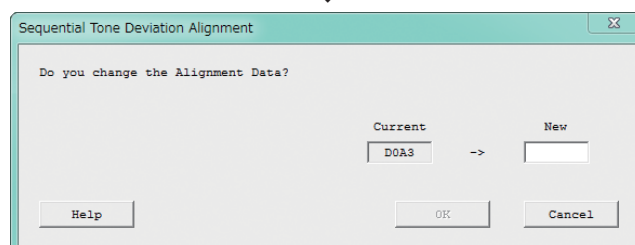
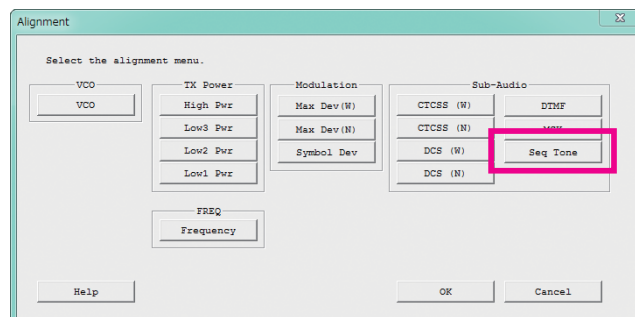

DOWNLOAD (SAVE) THE ALIGNMENT DATA AND EXIT FROM THE ALIGNMENT MODE

Press the “OK” button, then the Alignment Data will be downloaded (saved) to the transceiver and Exit from the Alignment Mode.

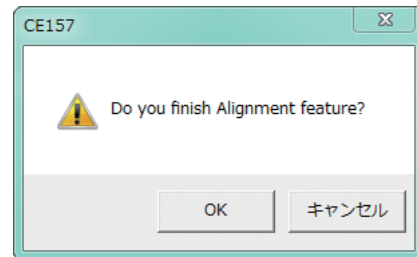
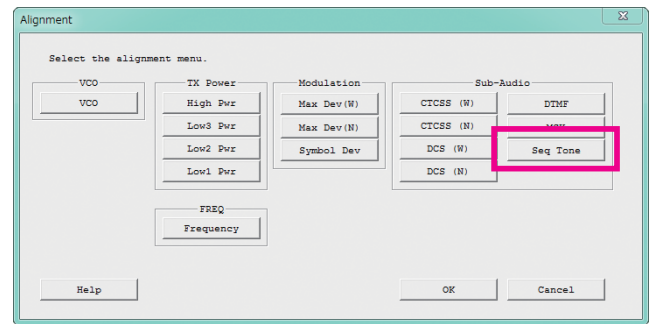

Main Unit (FR028210D)

Circuit Diagram (RF Section)

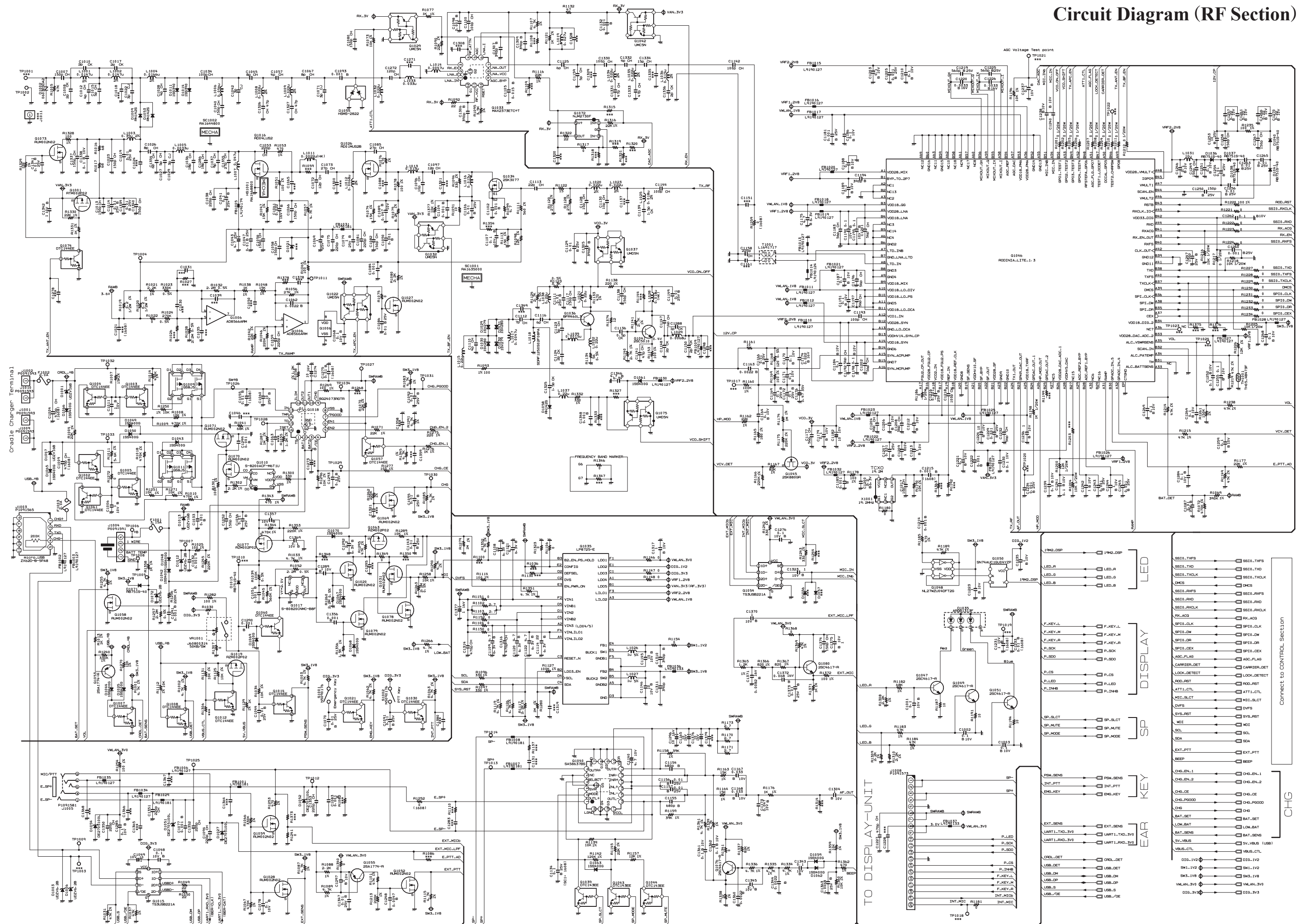

Main Unit (FR028210D) Circuit Diagram (CONTROL SECTION)

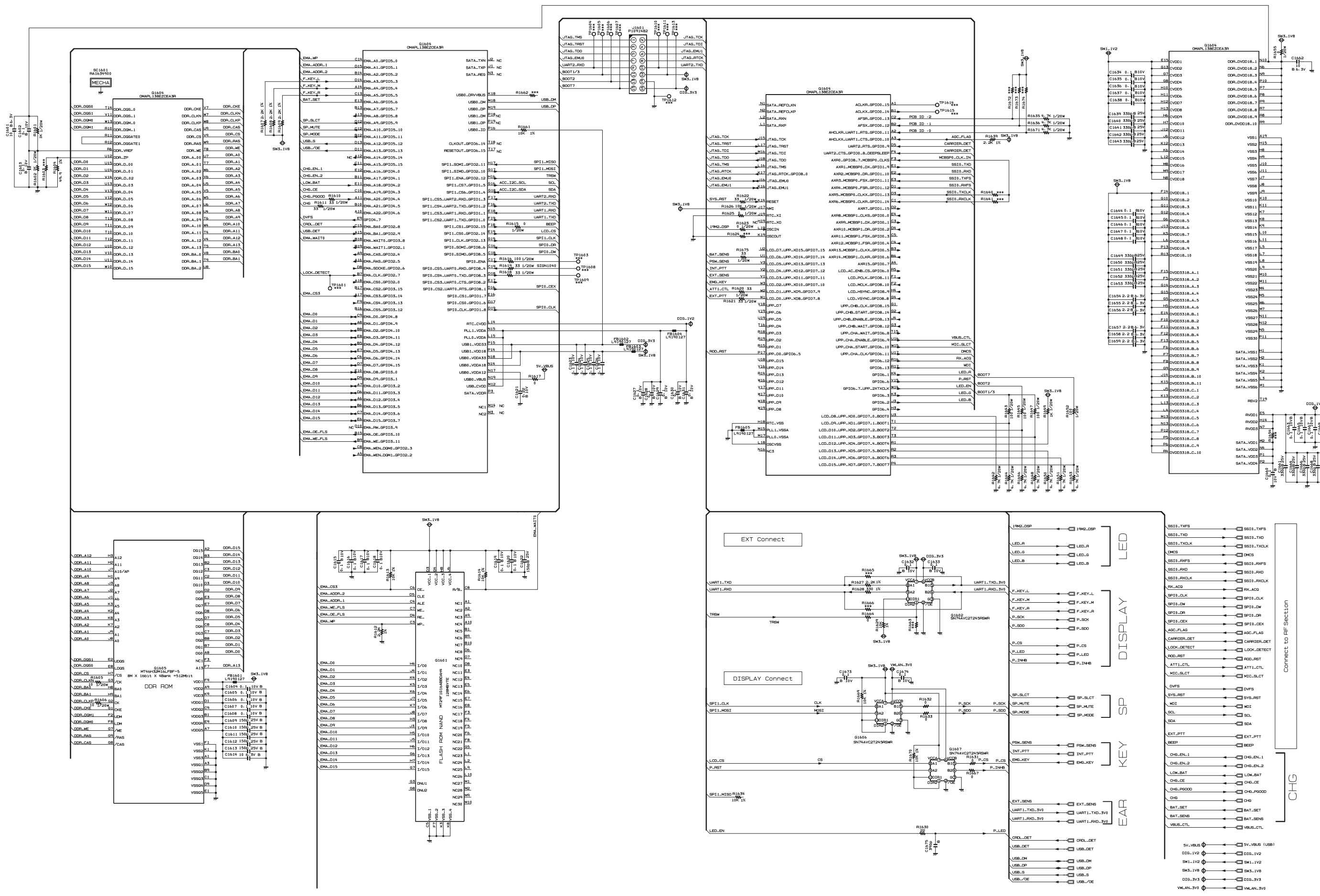

Display Unit (FR028310A)

Circuit Diagram

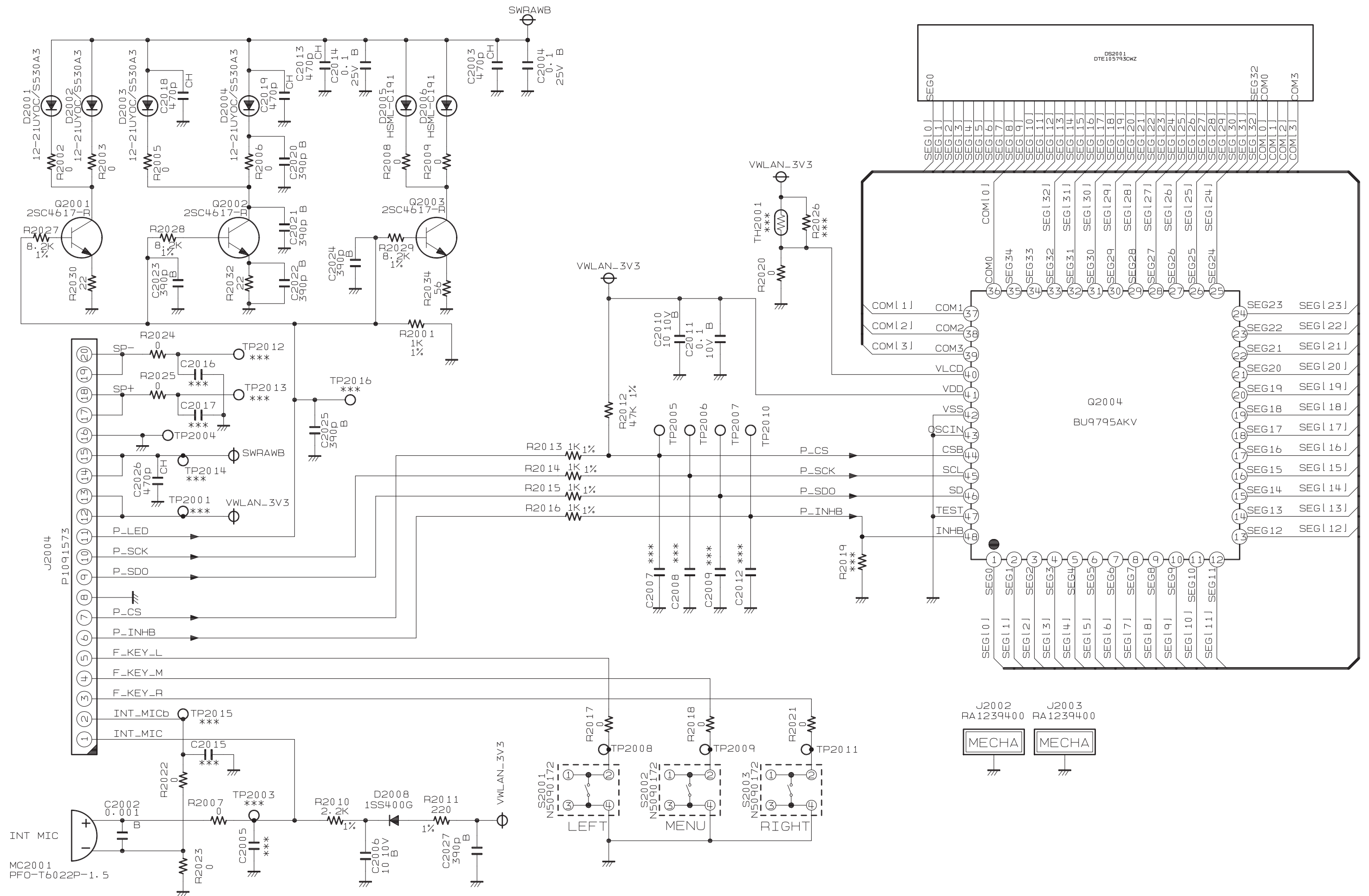

No portion of this manual may be reproduced without the permission of Vertex Standard LMR, Inc.
Vertex Standard is a trademark of Vertex Standard LMR, Inc.
All other trademarks are the property of their respective owners.

©2020 Vertex Standard LMR, Inc.
All rights reserved.