

TLKR T60/T60Z/T61 OWNER'S MANUAL



RF ENERGY EXPOSURE AND PRODUCT SAFETY GUIDE FOR PORTABLE TWO-WAY RADIOS

ATTENTION!

Before using this product, read the RF Energy Exposure and Product Safety Guide that ships with the radio which contains instructions for safe usage and RF energy awareness and control for compliance with applicable standards and regulation.

Package Contents

- 2 x TLKR T60/T60Z/T61 Radio
- 2 x Belt Clip
- 1 x Charging Cradle
- 1 x AC Adapter
- 2 x Battery support brackets
- 2 x Rechargeable NiMH battery packs
- TLKR T60/T60Z/T61 Owner's Manual

Frequency Chart

Ch.	Freq. (MHz)	Ch.	Freq. (MHz)	Ch.	Freq. (MHz)
1	446.00625	4	446.04375	7	446.08125
2	446.01875	5	446.05625	8	446.09375
3	446.03125	6	446.06875		

Features and Specifications

- 8 PMR Channels
 - 121 Sub-Codes (38 CTCSS Codes & 83 DCS codes)
 - Up to 8 km Range*
 - Internal VOX Circuitry
 - 5 Selectable Call Tone Alerts
 - Backlit LCD Display
 - Headset Jack for Optional Headset
 - Roger Beep
 - Up Timer
 - Room Monitor
 - Battery Charger
 - Battery Level Meter
 - Channel Monitor
 - Channel Scan
 - Dual Watch
 - Keypad Lock
 - Auto Power Off
 - Power Source: NiMH battery Pack / 4 AAA Alkaline batteries
 - Battery Life: 16 Hours (under typical use conditions)
- *Range may vary depending on environmental and/or topographical conditions.

Control and Functions

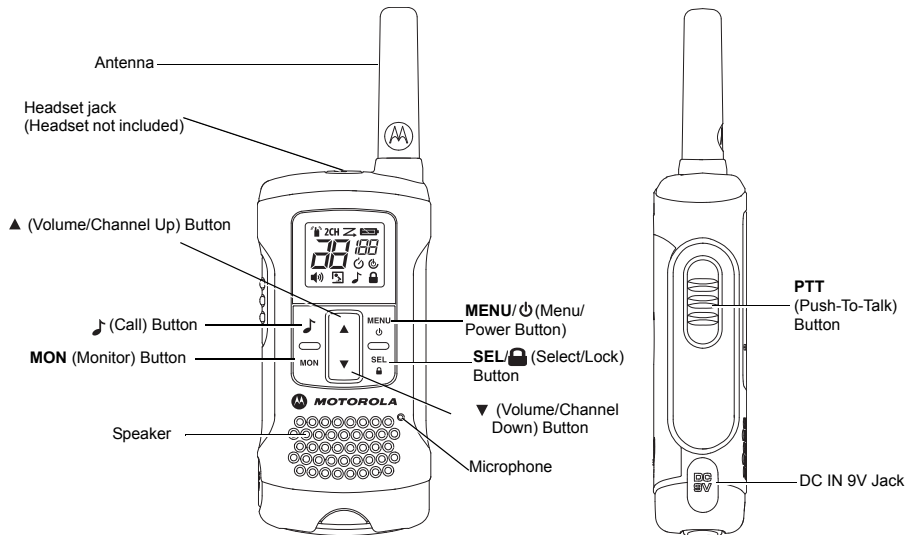

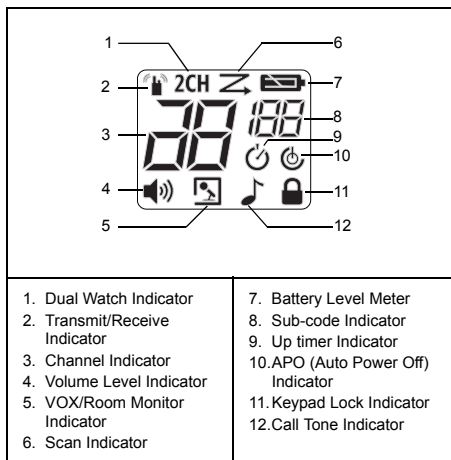

Display



Installing the Battery

1. Make sure your radio is turned OFF.
2. To remove the battery compartment door, press the tab at the bottom of the compartment door.
3. Install the NiMH batteries into the battery compartment.
4. Replace the battery compartment door.

Battery Level and Low Battery Alert

	Indicates that the battery is fully charged.
	Blinks when battery is low; charge the radio or replace batteries immediately.

Charging the Radio

Using the Charging Cradle :

1. Make sure your radio is turned OFF.
2. Connect the AC adapter to the DC IN 9V of the charging cradle.
3. Place the charging cradle on a stable surface.
4. Place the radio in the charging cradle with the keypad facing forward.
5. LED indicator will illuminate and remain illuminated as long as the radio is in the charger.

Note: Charge the battery pack for 16 hours.

Using the Battery Support Bracket :

1. Remove the rechargeable NiMH battery pack from the radio.
2. Place the battery support bracket into the charging cradle.
3. Install the NiMH battery pack into the charging cradle. Ensure that the charging contacts are correctly aligned.
4. LED indicator will illuminate and remain illuminated as long as the radio is in the charger.

Note: Charge the battery pack for 16 hours.

Battery Capacity Maintenance

1. Charge the batteries at least once every 3 months when not in use.
2. Remove the battery from the radio after using for storage purpose.
3. Store the batteries in temperatures between -20°C to 35°C and in low humidity. Avoid damp conditions and corrosive materials.



Basic Radio Operations

Read this reference guide completely before attempting to operate the unit.

Turning your Radio On/Off

Press and hold the **MENU/**  button to turn your radio ON/OFF.

Adjusting the Volume

Adjust the volume by pressing the  and  buttons.





Adjusting the Sound (Key Beeps)



Your radio emits a beep each time one of the buttons is pressed (except the **PTT** and  button).

Press and hold the  button while turning the radio ON to switch the sound ON/OFF.



Navigating through the Menu

Your radios has two Menu functions: Select Menu and Mode Menu.

1. To enter the Select Menu, press the **SEL/**  button.
2. To enter the Mode Menu, press the **MENU/**  button.
3. Additional presses of the **SEL/**  button or **MENU/**  button will advance you through the Menu.
4. To exit the Menu function, do one of the following :

- a. Press and hold the **MENU/**  button.
- b. Press and hold the **PTT, MON** or the  button.
- c. Wait 10 seconds until the unit automatically returns to "Normal" mode.

Talking on Your Radio



1. Hold your radio 5–8 cm from your mouth.
2. Press and hold the **PTT** button while speaking. The  appears on the display.
3. Release the **PTT** button. You can now receive incoming calls. When you do, the  appears on the display. To respond, repeat procedure from step 1.

Note: When you continue to transmit for 60 seconds, the radio emits TX Time Out tone and the  icon flashes. The radio will stop transmitting.



In order to speak to someone, both your radios must be set to the same channel and Sub-Code. Refer to "Selecting a Channel and a Sub-Code" below.

Selecting a Channel and a Sub-Code

To select a Channel:

1. **SEL/**  button to enter Select Menu. Advance until the Channel indicator blinks.
2.  or  to the required channel.

To select a Sub-code :

1. **SEL/**  button to enter Select Menu. Advance until the Sub-code indicator blinks.
2.  or  to the required Sub-code.
3. Exit the Select Menu.

Select Menu

Your radio navigates through the Select Menu as follows:

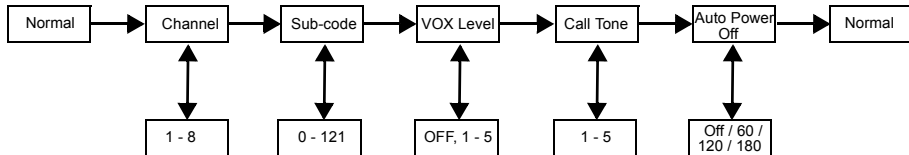

Voice Operated Transmission (VOX)

Transmission is initiated by speaking into the microphone of radio or headset (headset is not included) instead of the pushing the PTT button.

To select the VOX level:

1. **SEL/** button to enter Select Menu. Advance until blinks.
2. **▲** or **▼** to the desired VOX sensitivity level.
3. Exit the Select Menu.

Note: Level of(OFF) disables VOX. Levels 1-5 set the sensitivity of the VOX circuit. Use level 1 in quiet environments, and use level 5 in very noisy environments. You can find the appropriate sensitivity level by speaking into the microphone. If the flashes, your voice is accepted.

Transmitting a Call Tone

Your radio is equipped with 5 selectable call tones.

To select a call tone:

1. **SEL/** button to enter Select Menu. Advance until blinks.
2. **▲** or **▼** to the desired call tone.
3. Exit the Select Menu.

To transmit the selected call tone :

1. to transmit the selected call tone. The selected tone will automatically be transmitted for a fixed length of time.
2. **PTT** to cancel Call Tone.

Auto Power Off

Auto Power Off feature allows you to set the time that the radio turns off automatically.

1. **SEL/** button to enter Select Menu. Advance until and the current Auto Power Off time blinks.
2. **▲** or **▼** to select the time from **oF** (Off), 60, 120 and 180 minutes.
3. Exit the Menu.

Mode Menu

Your radio navigates through Mode Menu as follows:

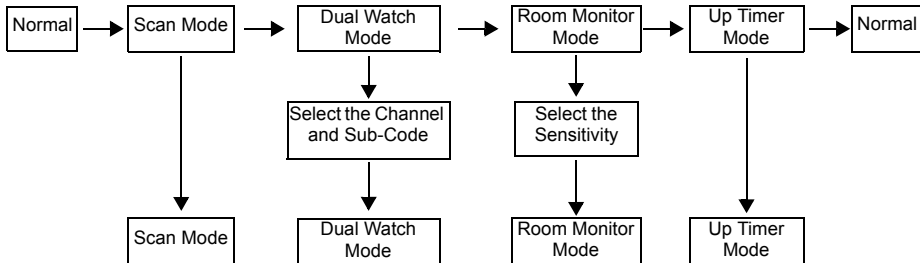

Features on Your Radio

Channel Scan Mode

Enables your radio to scan for active channels. When activity is detected, your radio lands (stays) on that channel (for 2 seconds). To transmit on that channel, press the **PTT** button. When activity on the landed channel ends, your radio continues scanning other channels.

To turn the channel scan ON:

1. **MENU/** to enter Mode Menu. Advance until blinks.
2. **SEL/** to turn ON channel scan.
3. **MENU/** , or **PTT** to turn OFF Scan mode.

Dual Watch Mode

Enables your to scan the current channel and another channel alternately.

To set another channel and start Dual Watch:

1. **MENU/** to enter Mode Menu. Advance until **2CH** blinks.
2. **▲** or **▼** to select the channel, then press **SEL/** .
3. **▲** or **▼** to select the Sub-code, then press **SEL/** .
4. The radio starts to Dual Watch.



Note: If you set the same channel and Sub-code as the current channel, Dual Watch doesn't work.

5. **MENU/** to turn the Dual Watch mode OFF.

Room Monitor

Enables your radio to detect voice/noises (according to the sensitivity level set) and transmit back to the listening radio without pushing the **PTT** button. The monitoring radio is not able to receive any transmissions in this mode.

To turn Room Monitor ON:

1. **MENU/**  to enter Mode Menu. Advance until  blinks.
2. **▲** or **▼** to the desired room monitor sensitivity level.

Note: Use level 1 in quiet environments. Use level 5 in very noisy environments.

3. **SEL/**  to turn ON room monitor.





MENU/  to turn OFF Room Monitor.

Note: When the voice/noise in the monitored room continues for more than 60 seconds, the monitoring radio stop monitoring for 5 seconds, and resumes.

Up Timer

Enables your radio to time up to 39 minutes 59 seconds. You can receive incoming calls in this mode.

To use up timer:

1. **MENU/**  to enter Mode Menu. Advance until  blinks.
2. **SEL/**  to select the Up Timer.
3. **▲** to start the Up Timer.
4. **MENU/** , **MON** or **PTT** to stop or reset up timer.

Key Lock

Press and hold **SEL/**  until  appears to lock the keypad.

Press and hold **SEL/**  until  disappears to unlock the keypad.



LCD Backlight

The LCD display will automatically illuminate for 10 seconds after any button is pressed (except for **PTT**).

Monitor Mode

Enables you to listen for weak signals on the current channel.

To turn the Monitor Mode ON:

1. Press the **MON** button for brief listening. The  icon blinks.
2. Press and hold the **MON** button for 2 seconds for continuous listening. The  icon continues to blink.

To turn the Monitor Mode OFF:

Press the **MON**, button to return to “Normal” mode. The  icon stops blinking.

Roger Beep

Sounds to indicate the end of a **PTT** or **VOX** transmission. It can be heard through the speaker when Key Beep is on. It cannot be heard through the speaker if Key Beep is turned off.

Press and hold the **▲** button while turning the radio ON to turn the Roger Beep ON. Repeat the step to turn Roger Beep OFF.

Automatic Power Save

For better battery life, your radio is designed to switch to Power Save mode when there has been no transmissions after 3 seconds. The radio can receive transmissions in this mode.

Warranty Information

The authorized Motorola dealer or retailer where you purchased your Motorola two-way radio and/or original accessories will honour a warranty claim and/or provide warranty service.

Please return your radio to your dealer or retailer to claim your warranty service. Do not return your radio to Motorola.

In order to be eligible to receive warranty service, you must present your receipt of purchase or a comparable substitute proof of purchase bearing the date of purchase. The two-way radio should also clearly display the serial number. The warranty will not apply if the type or serial numbers on the product have been altered, deleted, removed, or made illegible.

What Is Not Covered By The Warranty

- Defects or damage resulting from use of the Product in other than its normal and customary manner or by not following the instructions in this user manual.
- Defects or damage from misuse, accident or neglect.
- Defects of damage from improper testing, operation, maintenance, adjustment, or any alteration or modification of any kind.
- Breakage or damage to aerials unless caused directly by defects in material or workmanship.
- Products disassembled or repaired in such a manner as to adversely affect performance or prevent adequate inspection and testing to verify any warranty claim.
- Defects or damage due to range.
- Defects or damage due to moisture, liquid or spills.
- All plastic surfaces and all other externally exposed parts that are scratched or damaged due to normal use.
- Products rented on a temporary basis.
- Periodic maintenance and repair or replacement of parts due to normal usage, wear and tear.

Copyright Information

The Motorola products described in this manual may include copyrighted Motorola programs, stored semiconductor memories or other media. Laws in the United States and other countries preserve for Motorola, certain exclusive rights for copyrighted computer programs, including the exclusive right to copy or reproduce in any form, the copyrighted Motorola programs.

Accordingly, any copyrighted Motorola computer programs contained in the Motorola products described in this manual may not be copied or reproduced in any manner without express written permission of Motorola. Furthermore, the purchase of Motorola products shall not be deemed to grant either directly or by implication, estoppel, or otherwise, any license under the copyrights, patents or patent applications of Motorola, except for the normal non-exclusive royalty free license to use that arises by operation of law in the sale of a product.

EU Contact: Motorola Solutions GmbH, Am Borsigturm 130, 13507 Berlin, Germany.

MOTOROLA, MOTO, MOTOROLA SOLUTIONS and the Stylized M logo are trademarks or registered trademarks of Motorola Trademark Holdings, LLC and are used under license. All other trademarks are the property of their respective owners.

© 2012, 2013 Motorola Solutions, Inc. All rights reserved.



MOTOROLA SOLUTIONS

MOTOROLA, MOTO, MOTOROLA SOLUTIONS and the Stylized M logo are trademarks or registered trademarks of Motorola Trademark Holdings, LLC and are used under license. All other trademarks are the property of their respective owners.

© 2012, 2013, 2016 Motorola Solutions, Inc. All rights reserved



68015000924-CA

